

N4696D-02

# Modification Recommended Service Note

Supersedes:  
NONE

## N4696D Electronic Calibration Module (ECal)

Serial Numbers: MY57450000-MY99999999

**The Problem** – A resonance can develop in the heater circuit which can cause an RF tone between 140 MHz and 150 MHz to be injected onto the signal path.

### Parts Required:

P/N	Description	Qty.
N4690-63004	PCA, 2-port MW ECal Bottom Board	1

### ADMINISTRATIVE INFORMATION

ACTION	STANDARDS
CATEGORY: <input checked="" type="checkbox"/> AGREEABLE TIME	LABOR: 1.0 Hour

LOCATION	SERVICE:	USED
CATEGORY: <input checked="" type="checkbox"/> SERVICE CENTER	INVENTORY:	PARTS: <input checked="" type="checkbox"/> RETURN

AVAILABILITY: PRODUCT'S SUPPORT LIFE	NO CHARGE AVAILABLE UNTIL: 31 Dec 2024
--------------------------------------	--

<input checked="" type="checkbox"/> Calibration Required	PRODUCT LINE: WN
	AUTHOR: SS

ADDITIONAL INFORMATION:



**Situation:**

The heater circuit in the N469xD ECal modules was initially designed with a dampening capacitor. It was found in a small number of ECal modules that a resonance can develop in this circuit after the modules is warmed up. This resonance can cause an RF tone between 140 MHz and 150 MHz to be injected onto the signal path.

The dampening capacitor was eliminated in all ECal modules with serial prefix MY5941 and above.

**Solution/Action:**

Open the ECal module and remove the N4690-63004 printed circuit board. On this board, locate the C28 capacitor indicated here:

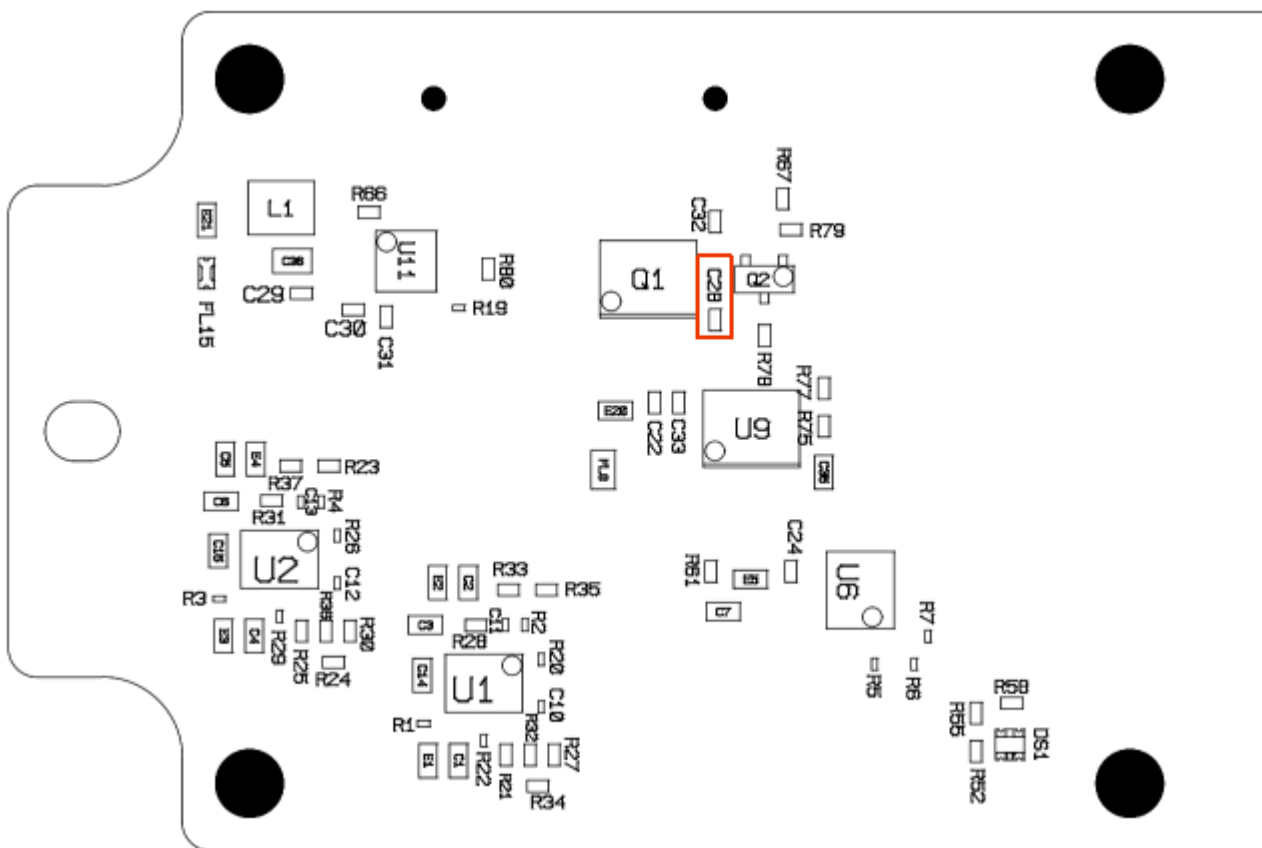

If this capacitor has been removed, no further action is required. Reassemble the ECal module.

If this capacitor exists on this board, this capacitor should be carefully unsoldered and removed, or the N4690-63004 printed circuit assembly should be replaced. Once this is done, reassemble the ECal module.

Revision History:

Date	Service Note Revision	Author	Reason for Change
03 Dec 2021	01	Scott Stewart	As Published