

PRIORITY SAFETY – REQUIRES IMMEDIATE REPAIR ACTION AND SPECIAL EFFORT TO CONTACT CUSTOMERS

DSO6034A-01A-S

S E R V I C E N O T E

Supersedes:
DSO6034A-01-S

DSO6034A 4-Channel, 300 MHz Oscilloscope

Serial Numbers: MY44001002

POSSIBLE SHOCK HAZARD

WARNING

The loss of earth ground and mechanical tolerance variations in PCA and instrument assembly may cause the power supply shield to short a trace to ground creating a shock hazard.

To Be Performed By: Agilent-Qualified Personnel

Parts Required:

P/N	Description	Qty.
54684-85402	Dielectric insulator	1

ADMINISTRATIVE INFORMATION

SERVICE NOTE CLASSIFICATION:		
PRIORITY SAFETY		
ACTION CATEGORY: X IMMEDIATELY	STANDARDS: LABOR: 0.5 Hours	
LOCATION CATEGORY: ON-SITE X SERVICE CENTER	SERVICE INVENTORY: <input type="checkbox"/> RETURN <input type="checkbox"/> SCRAP X SEE TEXT	USED PARTS: <input type="checkbox"/> RETURN <input type="checkbox"/> SCRAP X SEE TEXT
AVAILABILITY: ALWAYS	AGILENT RESPONSIBLE UNTIL: ALWAYS	
AUTHOR: DPM	PRODUCT LINE: 1A	
ADDITIONAL INFORMATION:		

© AGILENT TECHNOLOGIES, INC. 2007
PRINTED IN U.S.A.

March 19, 2007



Situation:

The loss of earth ground and mechanical tolerance variations in PCA and instrument assembly may cause the power supply shield to short a trace to ground creating a shock hazard.

Solution/Action:

The solution is to install dielectric insulator to the inside wall of the power supply shield. This modification to customer units will be performed by Agilent Technologies authorized service personnel at the customer site.

To perform the modification:

Read All Warnings and Cautions

Read the following warnings and cautions before performing this procedure.

WARNING -- HAZARDOUS VOLTAGES!

Only trained service personnel who are aware of the hazards involved should perform the maintenance. Whenever possible, perform the procedures with the power cord removed from the oscilloscope.

WARNING -- AVOID ELECTRICAL SHOCK!

Hazardous voltages exist on the LCD assembly and power supply. To avoid electrical shock:

1. Disconnect the power cord from the oscilloscope.
2. Wait at least three minutes for the capacitors in the oscilloscope to discharge before you begin disassembly.

CAUTION -- REMOVE POWER TO AVOID DAMAGE!

Remove power before you begin to remove and replace assemblies. Do not remove or replace assemblies while the oscilloscope is turned on, or damage to the components can occur.

CAUTION -- AVOID DAMAGE TO ELECTRONIC COMPONENTS!

ELECTROSTATIC DISCHARGE (ESD) can damage electronic components. When doing any of the procedures in this chapter, use proper ESD precautions. As a minimum, you should place the instrument on a properly grounded ESD mat and wear a properly grounded ESD strap.

To remove the cabinet

1. Turn off the oscilloscope and disconnect the power cable.
2. Rotate the handle to the up position as shown.
3. Using the T20 TORX driver, remove the two screws from the rear of the cabinet.
4. Using your thumbs, gently push on the rear-panel connectors to slide the oscilloscope out of the cabinet.

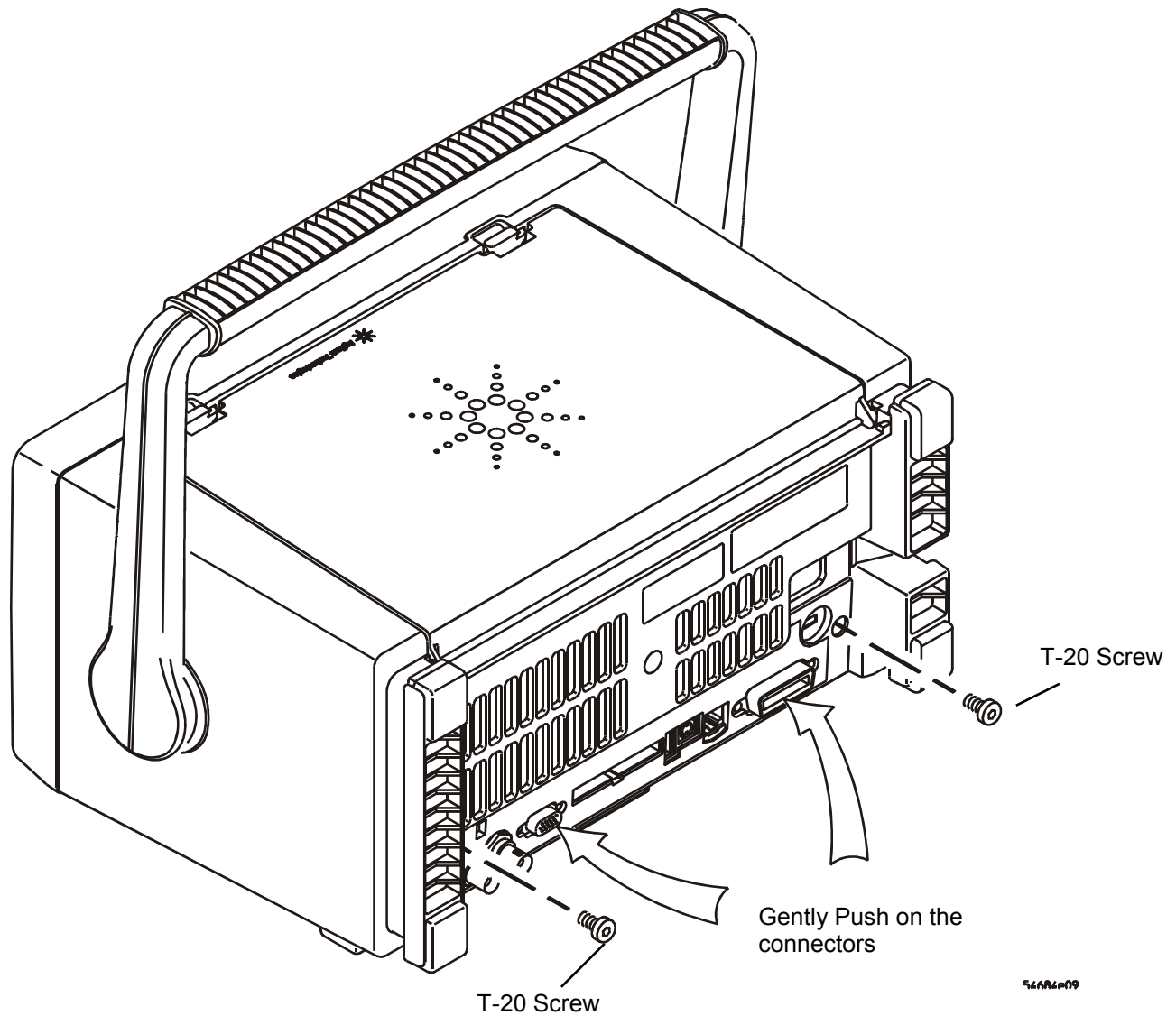

Figure 1 Remove the cabinet.

To remove the power supply shield

1. Pull back on each side of the shield until the 4 side hook legs clear their slots in the deck.

WARNING -- Thin sheet metal parts may have sharp edges. Handle with care to avoid injury.

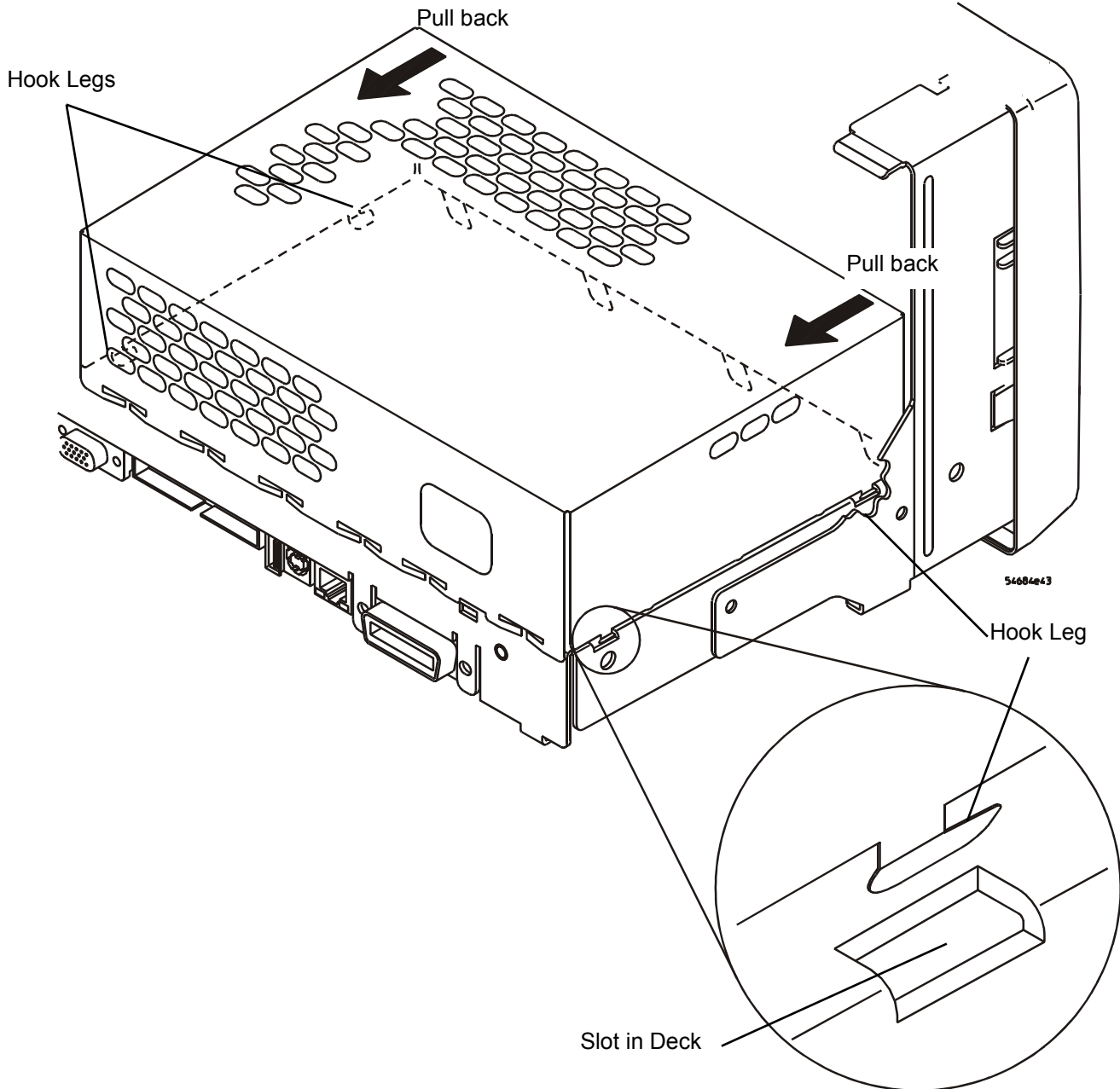

Figure 2 Release hook legs from deck.

2. Lift to remove the shield.

To install the dielectric insulator tape

1. Turn the shield on it's side as shown.
2. Clean the adhesion area on the shield with alcohol.

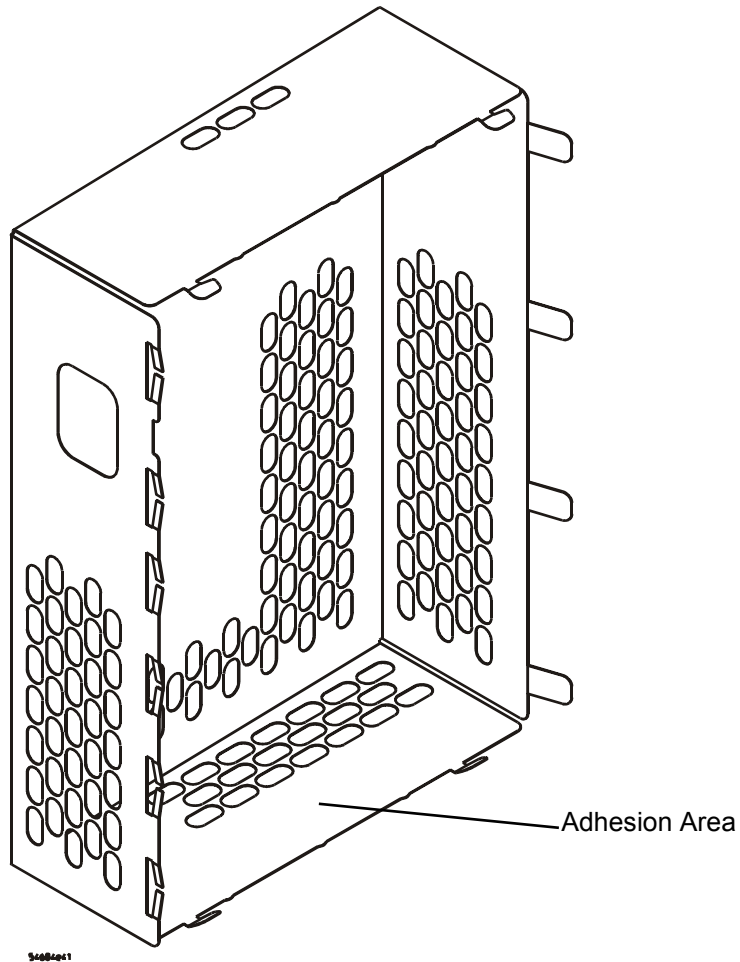

Figure 3 Prepare to install insulator.

3. Apply the dielectric insulator to the shield ensuring that it is within the tolerances shown.

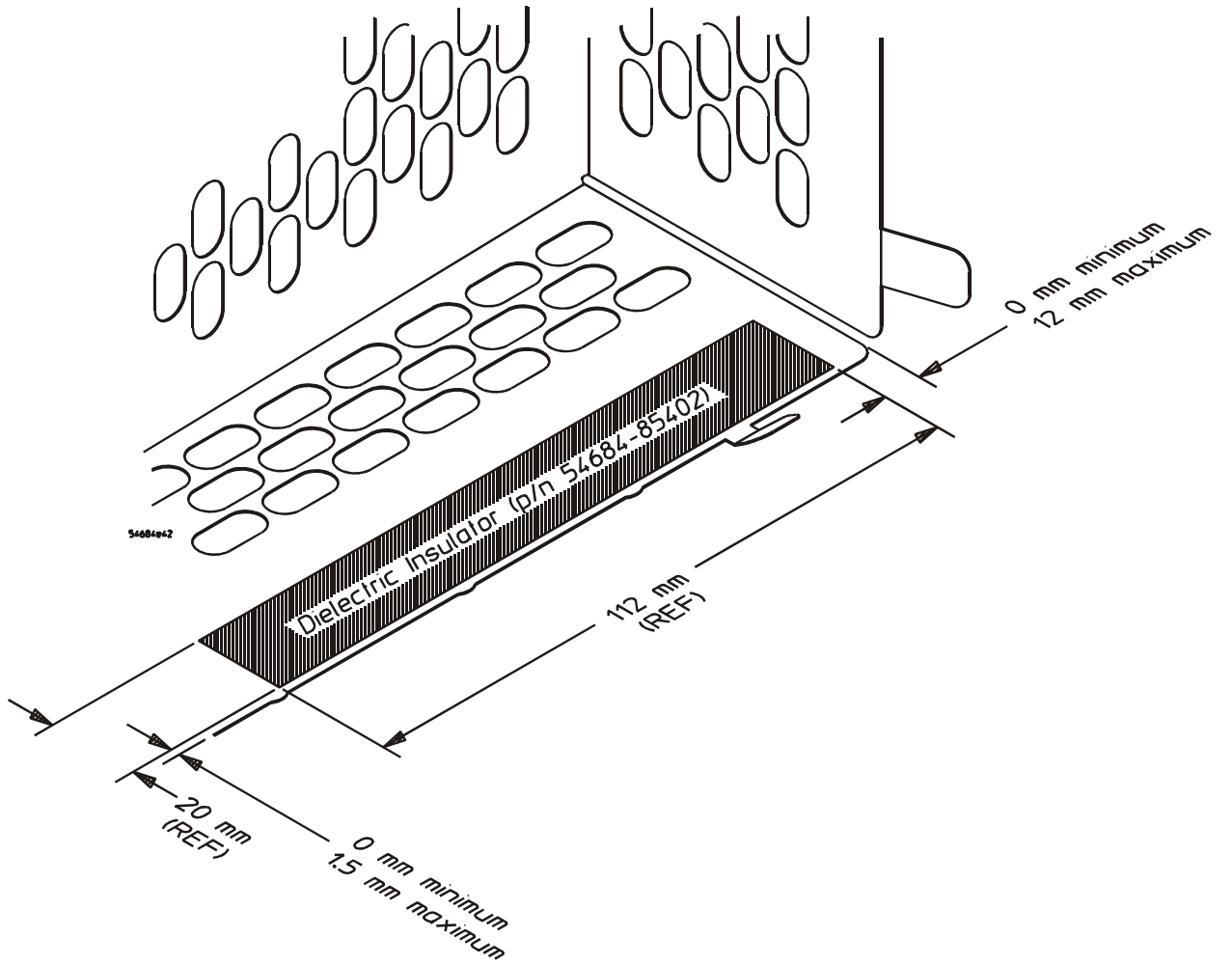

Figure 4 Apply dielectric insulator.

To reinstall the power supply shield

1. Ensure that tabs and hook legs have not been damaged.

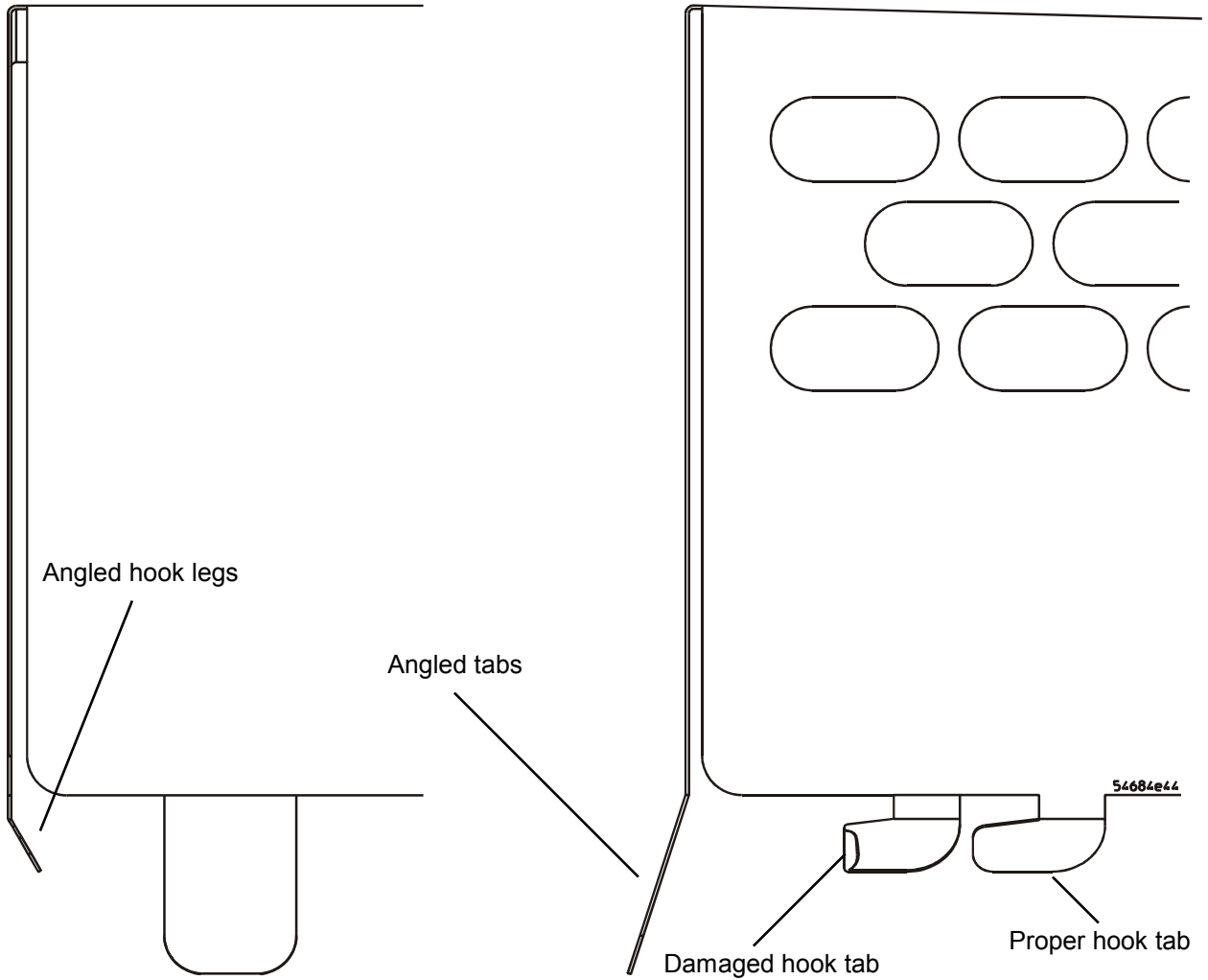

Figure 5 Proper angles for tabs and hook legs.

2. Insert the 4 tabs at the front of the shield by tilting the shield up.

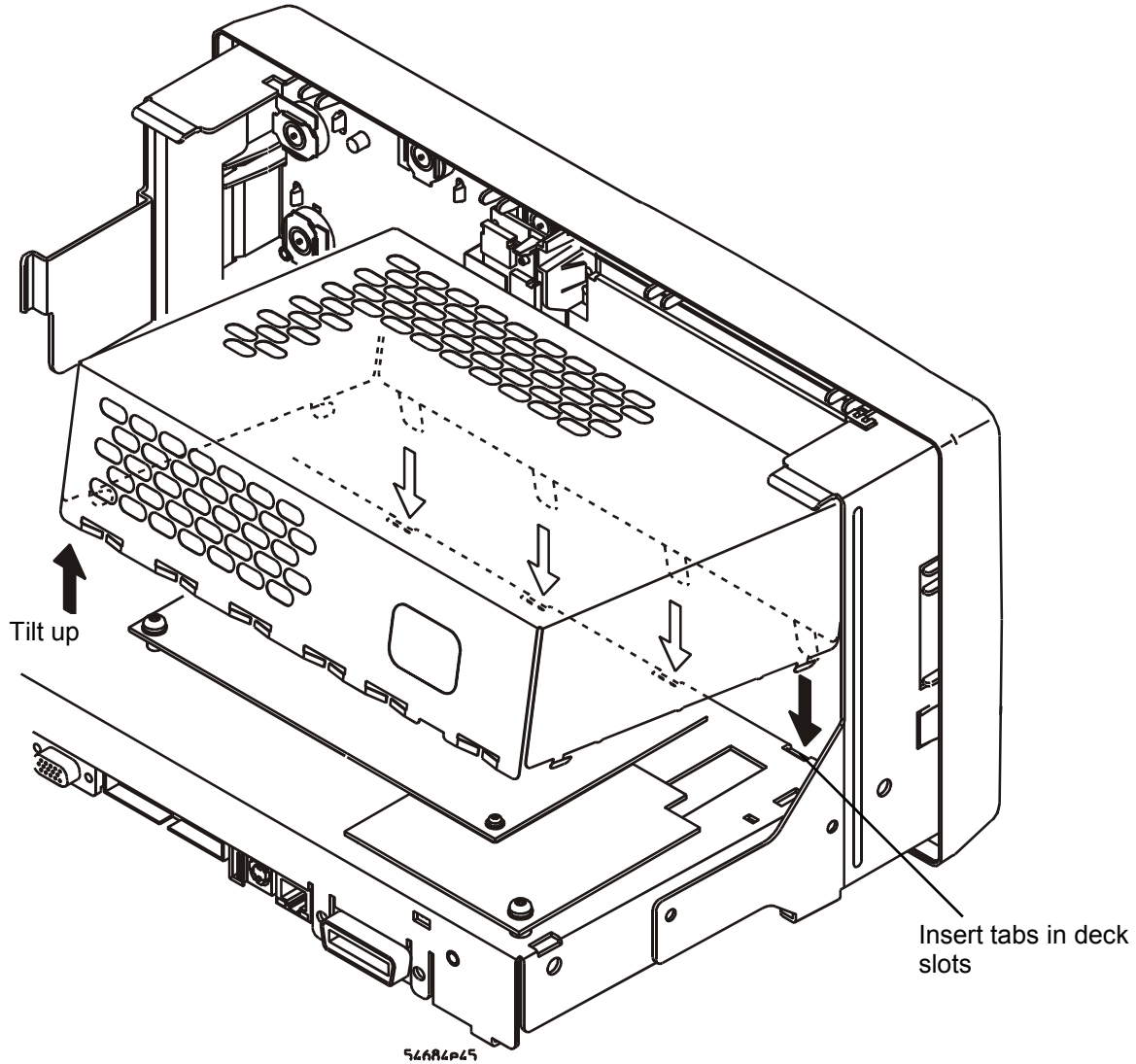

Figure 6 Tilt to insert tabs.

3. Tilt the shield down and pull back slightly to insert the 4 side hook legs into their deck slots.
4. Push the shield forward to lock into place.

Ensure all hooks and tabs are inserted correctly in their slots.

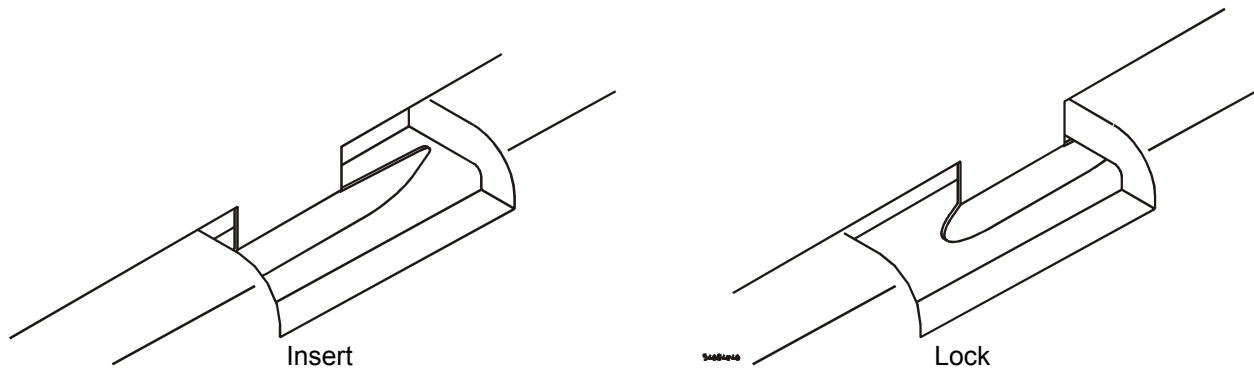

Figure 7 Insert hook legs and lock.

To reinstall the cabinet

1. Slide the oscilloscope into the cabinet until connectors are fully in their openings in the rear panel.
2. Replace the two T20 screws shown in Figure 1 on page 3.

Run user self test

Follow the instructions in the service guide to verify that the instrument passes User Self Test. No calibration is required.