



CURRENT TRACER
547A

O P E R A T I N G A N D S E R V I C E M A N U A L



Manual Part No. 00547-90006
Microfiche Part No. 00547-90007

Printed in U.S.A.

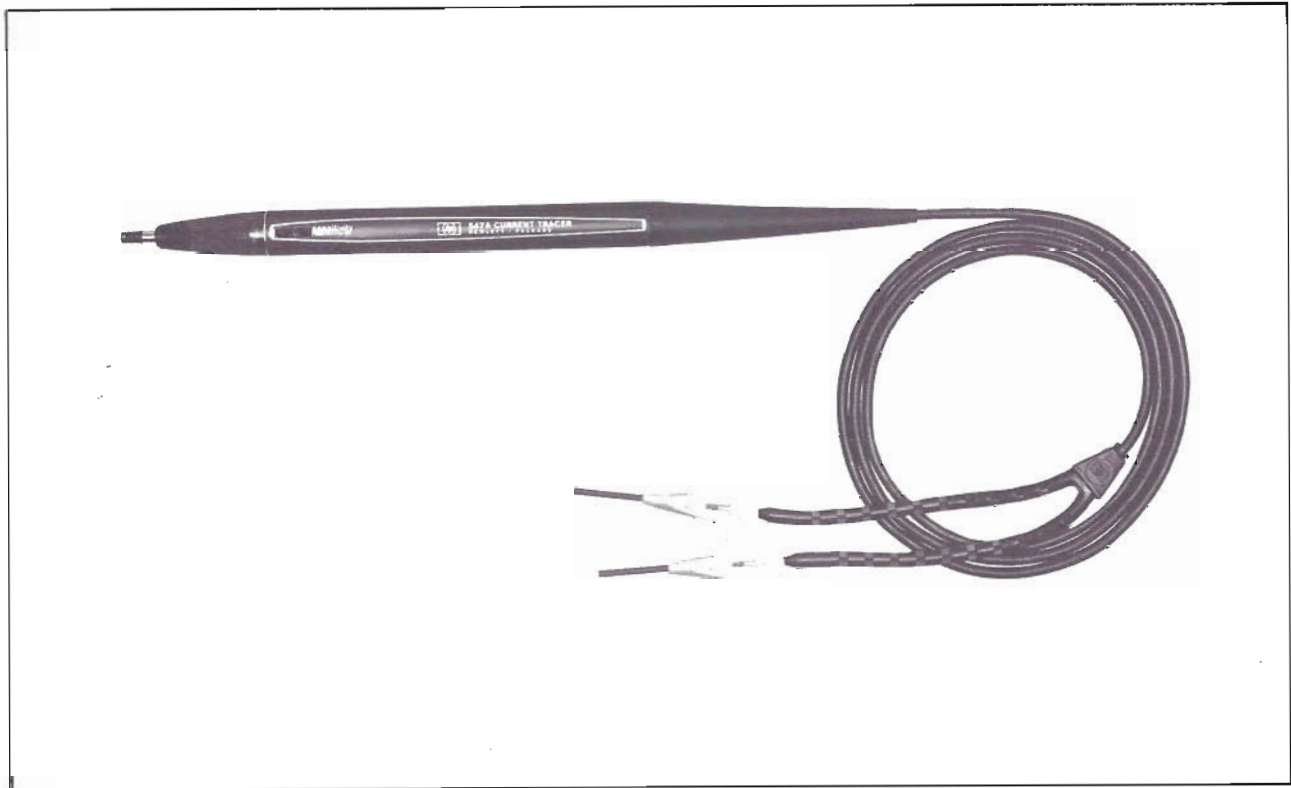

Figure 1. HP Model 547A Current Tracer

SCOPE OF MANUAL

This manual contains information about the Hewlett-Packard 547A Current Tracer. Coverage includes a description of the instrument, its applications, specifications, instructions in its use, theory of operation, maintenance, performance tests, adjustments, list of replaceable parts and how to obtain them, component locators, and schematics.

DESCRIPTION

The HP 547A Current Tracer is a hand-held probe which enables the precise localization of low-impedance faults in electrical systems. The probe senses the magnetic field generated by a pulsing current internal to the circuit or by current pulses supplied by an external stimulus such as the HP 546A or 10526T Logic Pulsers. Indication of the presence of current pulses is provided by lighting the indicator lamp near the Current Tracer tip. Adjustment of probe sensitivity over the 1 mA to 1A range is provided by the SENSITIVITY control near the indicator. The probe is self-contained and requires <math><75\text{ mA}</math> at 4.5V to 18V, from any convenient source.

INSTRUMENT IDENTIFICATION

Hewlett-Packard uses a 6-digit serial number (A00000) to identify the Current Tracer. If the serial number of your instrument differs from the serial number(s) on the title page of this manual, there are other differences between the manual and your instrument. These differences are covered in a "MANUAL CHANGES" sheet which is included with the manual.

SPECIFICATIONS

Table 1 lists all specifications for HP Model 547A Current Tracer.

Table 1. Model 547A Current Tracer Specifications

<p>INPUT:</p> <p>Sensitivity: 1 mA to 1A</p> <p>Frequency Response: Light indicates Single-step current transitions: single pulses ≥ 50 ns in width; pulse trains to 10 MHz (typically 20 MHz for current pulses ≥ 10 mA)</p> <p>Risetime: Light indicates current transitions with risetimes ≤ 200 ns at 1 mA.</p> <p>POWER SUPPLY REQUIREMENTS:</p> <p>Voltage: 4.5 to 18 Vdc</p> <p>Input Current: ≤ 75 mA</p> <p>Maximum Ripple: ± 500 mV above 5 Vdc</p> <p>Overvoltage Protection: ± 25 Vdc for one minute</p> <p>TEMPERATURE: 0° to 55°C</p> <p>WEIGHT: 113.4 g (4 oz.) net; Shipping Weight: 170 g (6 oz.)</p> <p>Size Probe body 15.24 cm (6 in.); Cable, 110.38 cm (47 in.)</p>	
---	--

APPLICATIONS

The Current Tracer operates on the principle that whatever is driving a low-impedance fault node must be delivering the majority of the current. Tracing the path of this current leads directly to the fault. Problems that are compatible with this method are:

- Shorted inputs of integrated circuits.
- Solder-bridges on printed-circuit boards.
- Shorted conductors in cables.
- Shorts in voltage distribution networks, e.g., Vcc-to-ground shorts.
- Stuck data buses, such as three state, open-collector, or Hewlett-Packard Interface Bus (HP-IB).
- Stuck wire-AND structure.

UNPACKING AND INSPECTION

If the shipping carton is damaged, ask that the carrier's agent be present when the Current Tracer is unpacked. Inspect the instrument for obvious damage such as dents, scratches, etc. If the instrument is damaged or fails to meet performance tests, notify the carrier and the nearest Hewlett-Packard Sales and Service Office immediately. Retain the shipping carton and the padding material for the carrier's inspection. The Sales and Service Office will arrange for the repair or replacement of the instrument without waiting for the claim against the carrier to be settled.

STORAGE AND SHIPMENT

To protect valuable electronic equipment during storage or shipment, always use the best packaging methods available. Your Hewlett-Packard Sales and Service Office can provide packaging material such as that used for original

factory packaging. Contract packaging companies in many cities can provide dependable custom packaging on short notice. Environmental conditions during storage and shipment should normally be limited as follows:

- a. Maximum altitude: 25,000 ft.
- b. Minimum temperature: -40°F (-40°C).
- c. Maximum temperature: $+149^{\circ}\text{F}$ ($+65^{\circ}\text{C}$).

OPERATING CHARACTERISTICS

Three conditions must be met before the Current Tracer can properly respond to circuit stimulus:

1. The mark on the probe's tip must be aligned along the length of the printed-circuit trace.
2. The probe be held perpendicular to the printed-circuit trace — not at an angle.
3. The printed-circuit trace must be conducting an alternating current, either from an internal source or, from an external stimulus such as a Logic Pulser with a rise-time of ≤ 200 ns.

NOTE

The voltage present on the black power supply lead (negative side of supply) is also present on the tracer's anodized aluminum case. Do not lay the tracer on any grounded area, such as an instrument chassis, unless the chassis is at the same potential as the black lead. Damage to the power supply may result.

CURRENT TRACER OPERATION

Use of the Current Tracer is indicated when conventional troubleshooting reveals a low-impedance fault. The operator aligns the mark on the probe tip along the length of the printed-circuit trace at the driver and adjusts the sensitivity control until the indicator lamp just lights. The probe is then moved along the trace or placed directly on the terminal points of the nodes (or IC pins), while observing the indicator light. This method of

following the path of the current leads directly to the fault responsible for the abnormal current flow. If the driving point does not provide pulse stimulation, the node may be driven externally by using a Logic Pulser at the driving point. The following paragraphs describe troubleshooting techniques for some of the more common problems.

Wire-AND Node

One of the most difficult problems encountered in troubleshooting integrated circuits is a stuck wire-AND node. Typically, one of the open-collector gates may still continue sinking current after it has been turned off. The Current Tracer provides an easy method of identifying the fault gate.

Referring to Figure 2 place the Current Tracer on the gate side of the pull-up resistor. Align the mark on the probe tip along the length of the printed-circuit trace and adjust the probe's sensitivity control until the indicator is just fully lighted. If the indicator will not light — use a Logic Pulser to excite the line. Place the tracer tip on the output pin of each gate; only the faulty gate will cause the indicator to light.

Gate-to-Gate Faults

When a low-impedance fault exists between two gates, the Current Tracer and Logic Pulser combine to quickly pinpoint the defect. In Figure 3 gate A's output is shorted to ground. Place the pulser midway between the two gates and place the Current Tracer's tip on the Pulser's pin. Pulse the line and adjust the Current Tracer's sensitivity control until the indicator just lights. First place the Current Tracer tip next to gate A and then gate B while continuing to excite the trace. The tracer will light only on the gate A side, since gate A, (the defect in this example), is sinking the majority of the current.

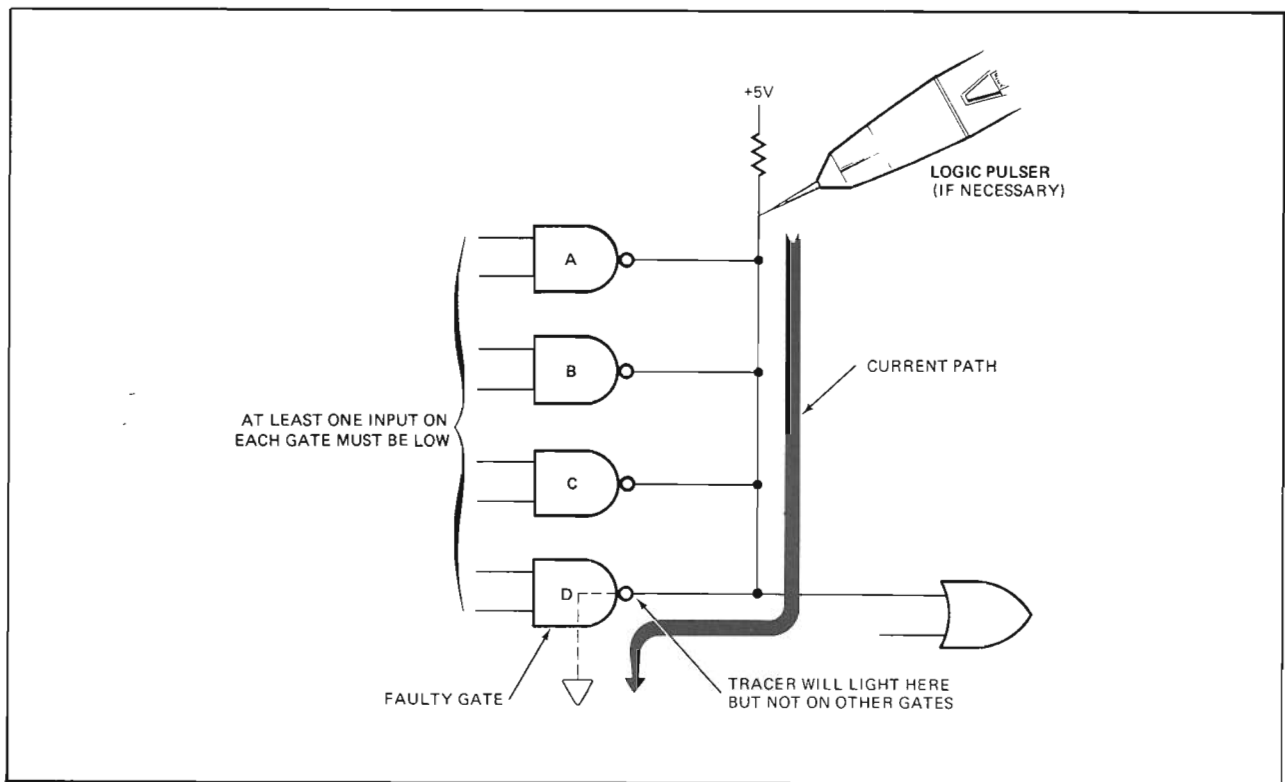

Figure 2. Wire-AND Node Fault

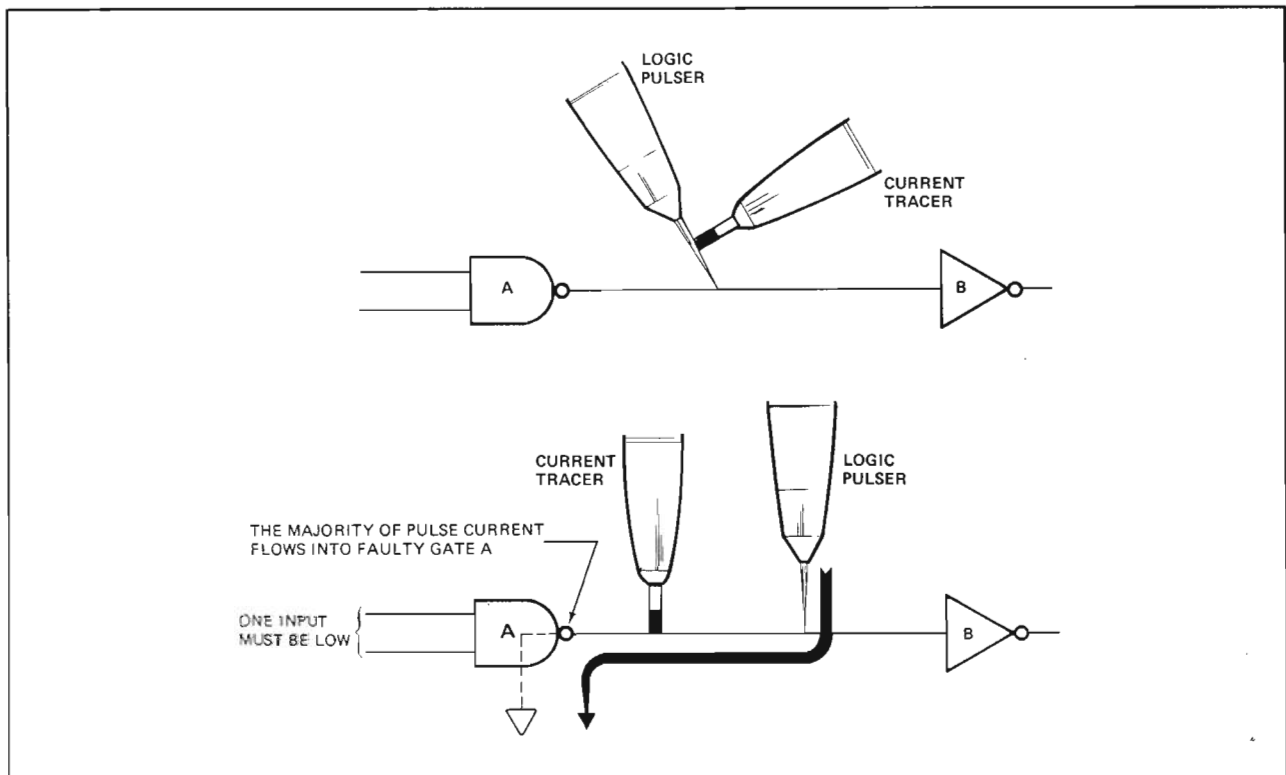

Figure 3. Gate-to-Gate Faults

Solder Bridge/Cable Problems

When checking printed-circuit traces which may be shorted by solder-bridges or by other means, start the Current Tracer at the driver and follow the trace. Figure 4 shows an example of an incorrect current path due to a solder-bridge. As the tracer probe follows the trace from gate A toward gate B, the indicator remains lighted until it passes the bridge. This is an indication that the current has found some path other than the trace. Visually inspect this area for solder-splashes, gold-bridges, etc. These principles also apply when troubleshooting shorted cable assemblies.

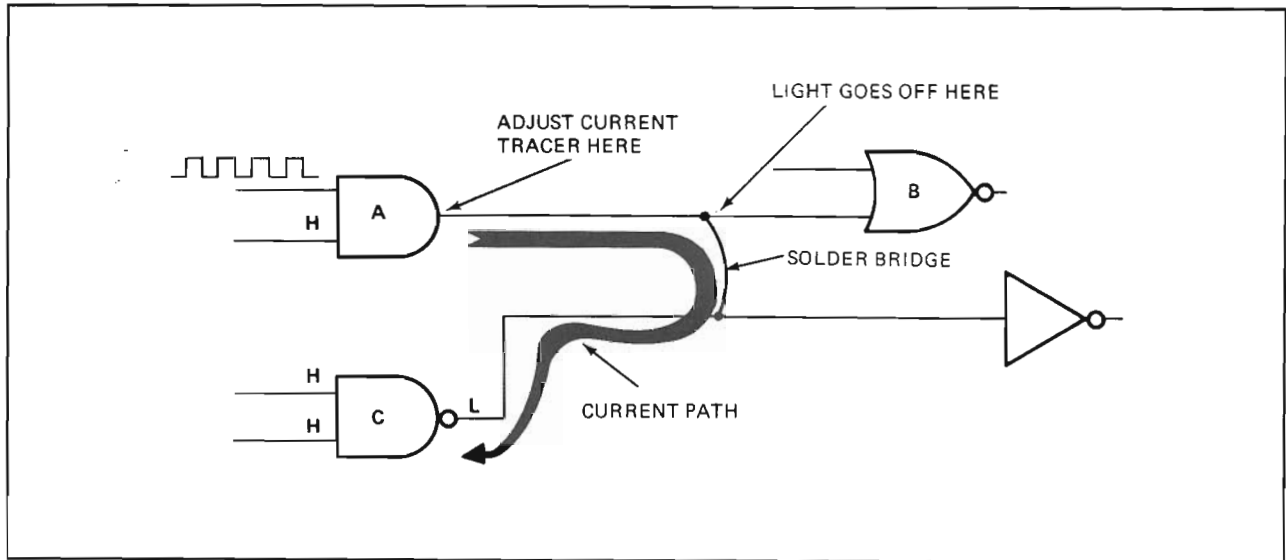

Figure 4. Solder-Bridge in Printed-Circuit

Multiple Gate Inputs

Another type of IC nodal structure is the one-output multiple-input configuration. Figure 5 shows this type of circuit being pulsed by a signal on gate A's input. In this case, place the Current Tracer's tip on the output pin of gate A and adjust the sensitivity control until the indicator light just comes on. Then check the input pins of gates B through E. If one of the input pins is shorted, that pin will be the only one to light the indicator.

Should the tracer fail to light when placed next to gate A's output, it is a good indication that the problem exists in gate A. To be sure that this is true, use the Pulser in the manner described under Gate-to-Gate Faults. If the circuit has no input signal to excite the node, use a Logic Pulser to excite the circuit.

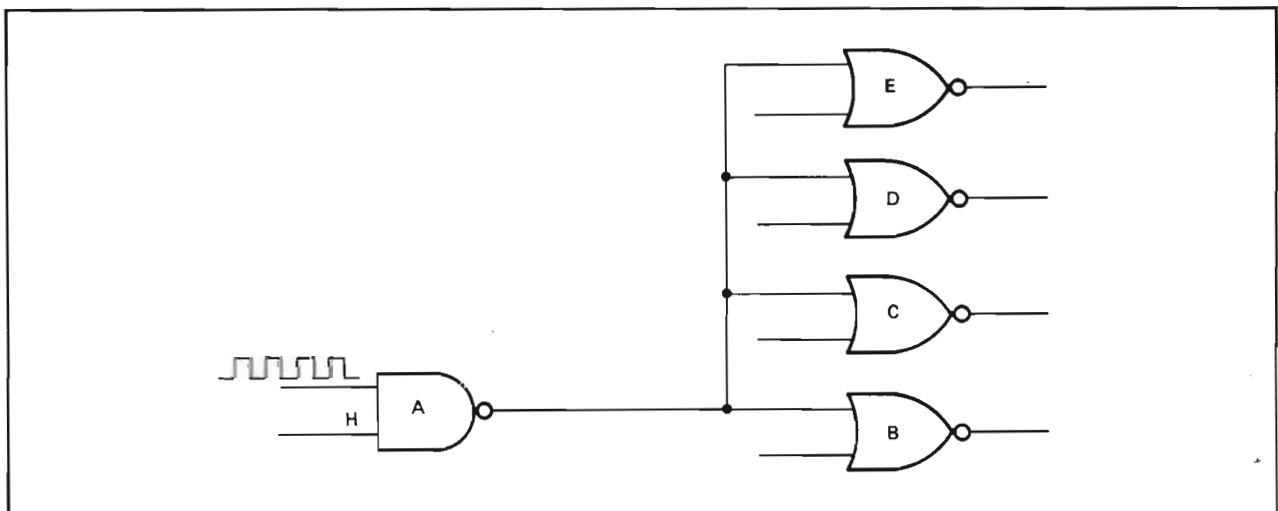

Figure 5. Multiple Gate Inputs

CMOS and ECL Circuits

Troubleshooting CMOS and ECL circuits is performed in the same manner as troubleshooting TTL circuits. The only difference is in the voltages available for the Current Tracer's power supply connections. The following table shows voltage range from each:

Circuit	Typical Voltage Supply Range
CMOS	3V to 15V
ECL	-5.2V → 0V
TTL	0V → 5V

CAUTION

THE VOLTAGE PRESENT ON THE BLACK POWER SUPPLY LEAD IS ALSO PRESENT ON THE TRACER'S ANODIZED ALUMINUM CASE. DO NOT LAY THE TRACER ON ANY GROUNDED AREA, SUCH AS AN INSTRUMENT CHASSIS. DAMAGE TO THE POWER SUPPLY MAY RESULT.

These are differences in potential and the Current Tracer's supply voltages may use both negative and positive, e.g., $V_{DD} = +8V$; $V_{SS} = -8V$. The Current Tracer is compatible with TTL, CMOS, and ECL circuits and operates on supply voltages from 4.5V to 18V. Connect the Current Tracer's black lead to the more negative supply line (V_{SS}) and the red lead to the more positive line (V_{DD}).

THEORY OF OPERATION (Refer to Figure 9 Schematic)

CURRENT-STEP SENSOR. The Current-Step Sensor comprises a pickup core and winding, and eddy-current shield. The signal to be traced is sensed by the pickup winding and core.

VARIABLE-GAIN PREAMP. The Variable-Gain Preamp consists of Q1 and peripheral components. The signal from the Current-Step-Sensor is fed directly to the base of Q1. The output of Q1 is taken directly to U1.

GAIN-CONTROL NETWORK. The gain of the Variable-Gain Preamp is controlled by ac-coupling the emitter and collector of Q1, via capacitors C4 and C5, to the current-controlled variable resistance presented by diode pairs CR4-CR6, and CR5-CR7. Each end of each diode pair is returned to signal ground or one of the ac grounds formed by capacitors C6, C7, and C8. Diodes CR1, CR2, and CR3 determine the control current for the diode pairs. The Gain-Control Network adjusts the gain of the Variable-Gain Preamp from -40 dB to +20 dB with essentially constant, high bandwidth.

FIXED-GAIN AMPLIFIER. U1 serves to increase the output of the Variable-Gain Preamp. Interstage ac-coupling of U1 is effected via R12 and C10.

AMPLIFIER AND BIPOLAR PEAK DETECTOR. The output of the Fixed-Gain Amplifier is ac-coupled through C12 to amplifier U2 which provides additional gain. The output of this amplifier is internally coupled to a bipolar peak detector (p/o U2) where a pulse of either polarity results in rapid charging of C14. This charging signal, a positive, stretched version of the input, with an amplitude proportional to the input, discharges through R20.

2ND PEAK DETECTOR. The output of the Bipolar Peak Detector is fed into another peak-detector consisting of an operational-amplifier (p/o U3), with an additional stage in the feedback loop (p/o U2). When the signal on C14 is positive, C15 is rapidly charged by U2 until the inputs to the operational-amplifier are equalized. The charge on C15 slowly discharges through R18, stretching the input pulse for sufficient time to light the indicator lamp.

DC AMPLIFIER AND DISPLAY DRIVER. The signal at C15 is dc-coupled to this amplifier, which consists of an operational-amplifier (p/o U3) and series-pass transistor Q3. The gain is set by R25 and R27; C19 is provided to suppress oscillations.

MAINTENANCE

PROBE DISASSEMBLY. To disassemble Current Tracer, refer to Figure 6, and proceed as follows:

1. With fingers, unscrew (ccw) the plastic indicator light window (MP4).
2. Slide the bottom shell off probe tip end (MP1).
3. Lift the top shell off the probe (MP2).
4. Carefully separate the circuit board and cable assembly.

PROBE ASSEMBLY. Reverse disassembly procedure.

CAUTION

BE CAREFUL WHEN REPLACING PARTS ON THE FRAGILE PRINTED-CIRCUIT BOARD. EXCESS HEAT CAN RUIN THE BOARD. USE A LOW WATTAGE SOLDERING IRON (≤ 25 WATTS) AND APPLY THE MINIMUM HEAT NECESSARY TO UNSOLDER THE LEADS.

PREVENTIVE MAINTENANCE. No periodic adjustment or preventive maintenance procedures are necessary for the Current Tracer.

ADJUSTMENTS. Potentiometer R21 is the only maintenance adjustment in the Model 547A. This trimmer may be used as a supplementary adjustment to the gain control (R3) and as a troubleshooting adjustment. Refer to information adjacent to the schematic diagram. Preliminary adjustment of R21 is made by setting the wiper arm approximately midway in its range. If this setting results in too little or too much sensitivity, with R3 set at the 1 mA end, then R21 can be adjusted to correct this. To assure there is 1 mA in the test circuit — refer to Figure 7.

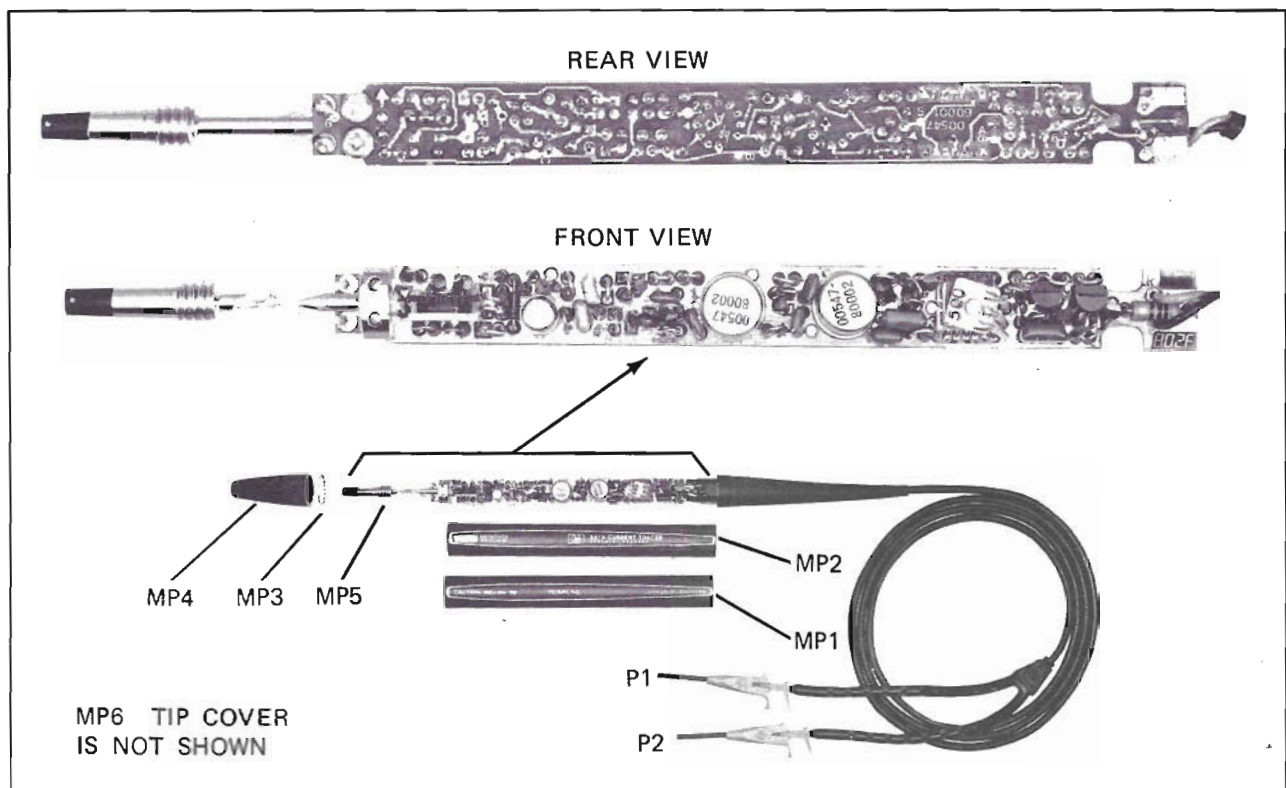

Figure 6. Exploded View of Current Tracer

PERFORMANCE TESTS

The following performance tests validate the dynamic range specifications of the 547A. Equipment required is listed below:

Equipment List for In-Cabinet Performance Tests

Instrument	Required Characteristics	Recommended HP Type
Pulse Generator	Single shot up to 10 MHz 50V, 1 Amp	HP 1915A
Power Supply	0-20 Vdc, Current Limiting at 75 mA.	HP 6823A
Decade Attenuator	40 dB	HP 355D
1 50 Ω	$\pm 1\%$, 0.5W	0811-0592
1 50 Ω	$\pm 5\%$, 20W	0819-0022

Minimum Current (1.0 mA) Performance Test

Equipment Required:

- a) HP 1915A Pulse Generator.
- b) HP 355D Decade Attenuator.
- c) HP 6823A Power Supply.
- d) 50 Ω , 1/2W Resistor.

CAUTION

USE A CURRENT-LIMITED POWER SUPPLY (75 mA), TO PREVENT DESTRUCTION OF TRANSISTORS Q2 AND Q3, DIODE CR8 AND COIL L1 IN EVENT TEST PROBE SHOULD ACCIDENTLY SLIP AND GROUND POINT "A".

With test equipment connected as shown in Figure 7, proceed as follows:

- a. Set attenuator to 0 (zero) dB.
- b. Set Pulse Generator to 5V at the output of attenuator.
- c. Set attenuator to 40 dB.
- d. Adjust power supply output to 4.5 volts with 75 mA current limiting.
- e. Adjust Current Tracer Sensitivity to the 1 mA end (all the way forward).
- f. Place Current Tracer tip at point "A".
- g. Orient Current Tracer for maximum magnetic coupling to the signal at point "A". (Point at which maximum brilliance of indicator occurs).
- h. Vary pulse generator frequency from single — step up to 10 MHz and observe that there is no visible change in indicator brilliance.
- i. Vary power supply output from 4.5 volts to 18 volts and observe that there is little or no change in the indicator brilliance.
- j. Disconnect test equipment.

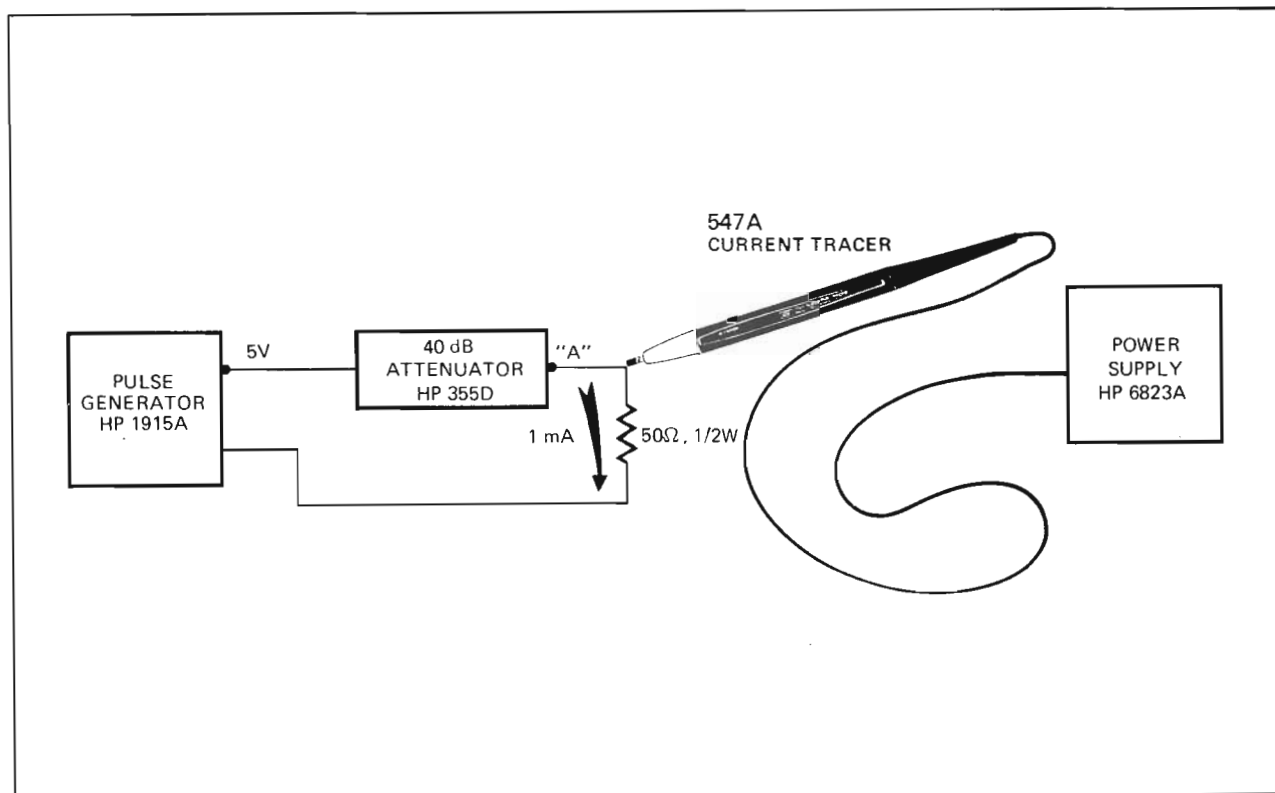

Figure 7. Setup for 1 mA Test

Maximum Current (1.0A) Performance Test

Test equipment required:

- a. HP 1915A Pulse Generator.
- b. HP 6823A Power Supply.
- c. 50Ω, 20W Resistor.

With test equipment connected as shown in Figure 8, proceed as follows:

1. Set pulse generator to 50V amplitude.
2. Adjust power supply output to 4.5 volts.
3. Set Current Tracer sensitivity control at the 1 A end.
4. Place current tracer tip at point "A".
5. Orient current tracer for maximum magnetic coupling to the signal at point "A". (This is the point at which maximum brilliance of the indicator is obtained.)
6. Vary pulse generator frequency from single-step up to 10 MHz and observe that there is no visible change in indicator brilliance.
7. Set pulse generator frequency to 1-kHz.
8. Vary power supply voltage from 4.5V to 18V and observe that there is little or no visible change in brilliance.
9. Disconnect test equipment.

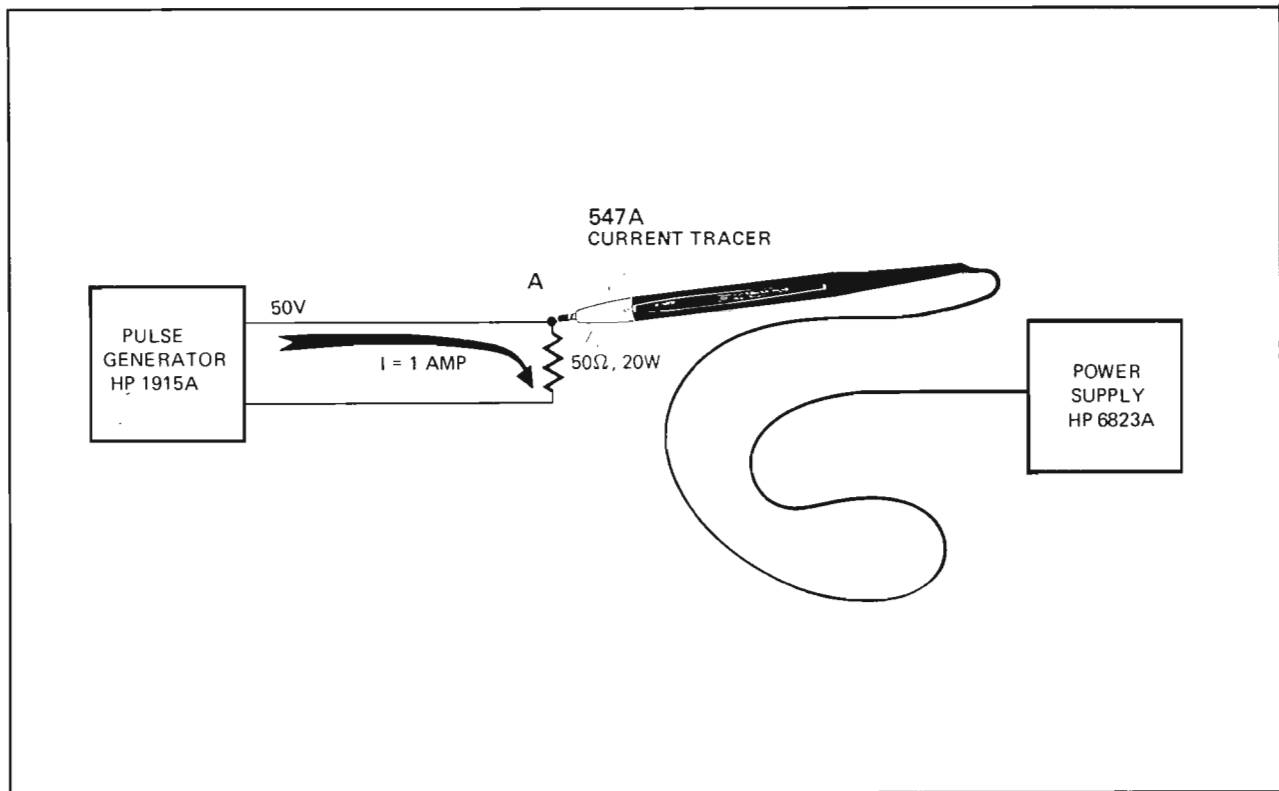

Figure 8. Setup for 1A Test

Table 2. Replaceable Parts List

Reference Designation	HP Part Number	Qty	Description	Mfr Code	Mfr Part Number
A1	00547-60001	1	BOARD ASSEMBLY CURRENT TRACER SERIES 1536 OR 1540	28480	00547-60001
A1C1	0180-0684	9	CAPACITOR-FXD 6.8UF±20% 6VDC TA	0044K	T374D685M006AS
A1C2	0180-0684		CAPACITOR-FXD 6.8UF±20% 6VDC TA	0044K	T374D685M006AS
A1C3	0180-0684		CAPACITOR-FXD 6.8UF±20% 6VDC TA	0044K	T374D685M006AS
A1C4	0160-0576	2	CAPACITOR-FXD .1UF ±20% 50WVDC CER	26654	2130BR050R104M
A1C5	0160-0576		CAPACITOR-FXD .1UF ±20% 50WVDC CER	26654	2130BR050R104M
A1C6	0180-0684		CAPACITOR-FXD 6.8UF±20% 6VDC TA	0044K	T374D685M006AS
A1C7	0180-0684		CAPACITOR-FXD 6.8UF±20% 6VDC TA	0044K	T374D685M006AS
A1C8	0180-0684		CAPACITOR-FXD 6.8UF±20% 6VDC TA	0044K	T374D685M006AS
A1C9	0160-0574	4	CAPACITOR-FXD .022UF ±20% 100WVDC CER	28480	0160-0574
A1C10	0160-0574		CAPACITOR-FXD .022UF ±20% 100WVDC CER	28480	0160-0574
A1C11	0180-0684		CAPACITOR-FXD 6.8UF±20% 6VDC TA	0044K	T374D685M006AS
A1C12	0160-0574		CAPACITOR-FXD .022UF ±20% 100WVDC CER	28480	0160-0574
A1C13	0160-0574		CAPACITOR-FXD .022UF ±20% 100WVDC CER	28480	0160-0574
A1C14	0160-4450	1	CAPACITOR-FXD .01UF ±50% 100WVDC CER	28480	0160-4450
A1C15	0160-4340	2	CAPACITOR-FXD 1.2UF ±0-20% 25WVDC CER	28480	0160-4340
A1C16	0180-0684		CAPACITOR-FXD 6.8UF±20% 6VDC TA	0044K	T374D685M006AS
A1C17	0180-0684		CAPACITOR-FXD 6.8UF±20% 6VDC TA	0044K	T374D685M006AS
A1C18	0160-4340		CAPACITOR-FXD .64UF ±.36UF 25WVDC CER	28480	0160-4340
A1C19	0180-2608	1	CAPACITOR-FXD .68UF±20% 35VDC TA	0044K	T374D684M035AS
A1CR1	1901-0040	5	DIODE-SWITCHING 30V 50NA 2NS DO-35	28480	1901-0040
A1CR2	1901-0040		DIODE-SWITCHING 30V 50NA 2NS DO-35	28480	1901-0040
A1CR3	1901-0040		DIODE-SWITCHING 30V 50NA 2NS DO-35	28480	1901-0040
A1CR4	1901-1068	2	DIODE-SCHOTTKY	28480	1901-1068
A1CR5	1901-0040		DIODE-SWITCHING 30V 50NA 2NS DO-35	28480	1901-0040
A1CR6	1901-1068		DIODE-SCHOTTKY	28480	1901-1068
A1CR7	1901-0040		DIODE-SWITCHING 30V 50NA 2NS DO-35	28480	1901-0040
A1CR8	1901-0519	1	DIODE-200V 50NS	28480	1901-0519
A1L1	9100-2265	1	COIL-FXD MOLDED RF CHOKE 10UH 10%	24226	10/102

Table 2. Replaceable Parts List (Continued)

Reference Designation	HP Part Number	Qty	Description	Mfr Code	Mfr Part Number
A1Q1	1854-0345 0340-0410	1	TRANSISTOR NPN 2N5179 SI TO-72 PD=200MW	04713	2N5179
A1Q2	1853-0389 0340-0410	3	INSULATOR-XSTR TO-18 .13-THK	07047	TRANSIPAD 10168
A1Q3	1853-0389 0340-0410	2	TRANSISTOR PNP SI TO-92 PD=350MW FT=4MHZ	28480	1853-0389
		1	INSULATOR-XSTR TO-18 .13-THK	07047	TRANSIPAD 10168
		1	TRANSISTOR PNP SI TO-92 PD=350MW FT=4MHZ	28480	1853-0389
		1	INSULATOR-XSTR TO-18 .13-THK	07047	TRANSIPAD 10168
A1R1	0698-7247	1	RESISTOR 2.87K 2% .05W F TC=0+-100	24546	C3-1/8-T0-2871-G
A1R2	0698-7260	4	RESISTOR 10K 2% .05W F TC=0+-100	24546	C3-1/8-T0-1002-G
A1R3	00547-80004	1	RESISTOR, VAR 3.53K OHM WITH MTG BKT	28480	00547-80004
A1R4	0698-7245	2	RESISTOR 2.37K 2% .05W F TC=0+-100	24546	C3-1/8-T0-2371-G
A1R5	0698-7260	1	RESISTOR 10K 2% .05W F TC=0+-100	24546	C3-1/8-T0-1002-G
A1R6	0698-7220	2	RESISTOR 215 2% .05W F TC=0+-100	24546	C3-1/8-T0-215R-G
A1R7	0698-7260	2	RESISTOR 10K 2% .05W F TC=0+-100	24546	C3-1/8-T0-1002-G
A1R8	0698-7233	4	RESISTOR 750 2% .05W F TC=0+-100	24546	C3-1/8-T0-750R-G
A1R9	0698-7233	4	RESISTOR 750 2% .05W F TC=0+-100	24546	C3-1/8-T0-750R-G
A1R10	0698-7209	2	RESISTOR 75 2% .05W F TC=0+-100	24546	C3-1/8-T0-75R0-G
A1R11	0698-7190	1	RESISTOR 12.1 2% .05W F TC=0+-100	24546	C3-1/8-T0-12R1-G
A1R12	0698-7243	2	RESISTOR 1.96K 2% .05W F TC=0+-100	24546	C3-1/8-T0-1961-G
A1R13	0698-7233	1	RESISTOR 750 2% .05W F TC=0+-100	24546	C3-1/8-T0-750R-G
A1R14	0698-7198	1	RESISTOR 26.1 2% .05W F TC=0+-100	24546	C3-1/8-T0-26R1-G
A1R15	0698-7228	1	RESISTOR 484 2% .05W F TC=0+-100	24546	C3-1/8-T0-484R-G
A1R16	0698-7209	1	RESISTOR 75 2% .05W F TC=0+-100	24546	C3-1/8-T0-75R0-G
A1R17	0698-7233	1	RESISTOR 750 2% .05W F TC=0+-100	24546	C3-1/8-T0-750R-G
A1R18	0698-7185	1	RESISTOR 220K 5% .125W CC TC=0+1176	01121	BB2245
A1R19	0698-7220	1	RESISTOR 215 2% .05W F TC=0+-100	24546	C3-1/8-T0-215R-G
A1R20	0698-7288	1	RESISTOR 147K 2% .05W F TC=0+-100	24546	C3-1/8-T0-1473-G
A1R21	2100-0956 00547-40004	1	RESISTOR-TRMR 500 20% CC SIDE-ADJ 1-TURN SUPPORT, PCT	71590	SERIES 3 00547-40004
A1R22	0698-7243	1	RESISTOR 1.96K 2% .05W F TC=0+-100	24546	C3-1/8-T0-1961-G
A1R23	0698-7245	1	RESISTOR 2.37K 2% .05W F TC=0+-100	24546	C3-1/8-T0-2371-G
A1R24	0698-7966	1	RESISTOR 680K 5% .125W CC TC=0+-850	01121	BB6845
A1R25	0698-7270	1	RESISTOR 26.1K 2% .05W F TC=0+-100	24546	C3-1/8-T0-2612-G
A1R26	0698-7249	2	RESISTOR 3.48K 2% .05W F TC=0+-100	24546	C3-1/8-T0-3481-G
A1R27	0698-7239	1	RESISTOR 1.33K 2% .05W F TC=0+-100	24546	C3-1/8-T0-1331-G
A1R28	0698-7249	1	RESISTOR 3.48K 2% .05W F TC=0+-100	24546	C3-1/8-T0-3481-G
A1R29	0698-7260	1	RESISTOR 10K 2% .05W F TC=0+-100	24546	C3-1/8-T0-1002-G

Table 2. Replaceable Parts List (Continued)

Reference Designation	HP Part Number	Qty	Description	Mfr Code	Mfr Part Number
A1U1	00547-80002	2	IC, LINEAR	28480	00547-80002
A1U2	00547-80002	2	IC, LINEAR	28480	00547-80002
A1U3	1826-0291	1	IC LM 324 OP AMP	27014	LM324F
A1DS1	2140-0378	1	LAMP-INCAND T-1 BULB 5V	00501	210
MP1	00547-20206	1	BODY, BOTTOM HALF	28480	00547-20206
MP2	00547-20207	1	BODY, TOP HALF	28480	00547-20207
MP3	2190-0104	1	WASHER, LOCK	28480	2190-0104
MP4	00547-40001	1	WINDOW, TIGHTENER	28480	00547-40001
MP5	5088-7024	1	TIP ASSEMBLY	28480	5088-7024
MP6	00547-40005	1	COVER, TIP	28480	00547-40005
P1	10230-62101	2	GRABBER	28480	10230-62101
P2	10230-62101	2	GRABBER	28480	10230-62101
W1	00547-60100	1	CABLE ASSEMBLY, PROBE	28480	00547-60100

Table 3. Manufacturers Code List

MFR NO.	MANUFACTURER NAME	ADDRESS	ZIP CODE
0044K	KEMET	MOUNTAIN VIEW CA	94040
00501	ILLUMINATED PRODUCTS INC	ANAHEIM CA	92803
01121	ALLEN-BRADLEY CO	MILWAUKEE WI	53212
04713	MOTOROLA SEMICONDUCTOR PRODUCTS	PHOENIX AZ	85008
07047	ROSS MILTON CO	SOUTHAMPTON PA	18966
24226	GOWANDA ELECTRONICS CORP	GOWANDA NY	14070
24546	CORNING GLASS WORKS (BRADFORD)	BRADFORD PA	16701
26654	VARADYNE INC	SANTA MONICA CA	90403
27014	NATIONAL SEMICONDUCTOR CORP	SANTA CLARA CA	95051
28480	HEWLETT-PACKARD CO CORPORATE HQ	PALO ALTO CA	94304
71590	CENTRALAB ELEK DIV GLOBE-UNION INC	MILWAUKEE WI	53201

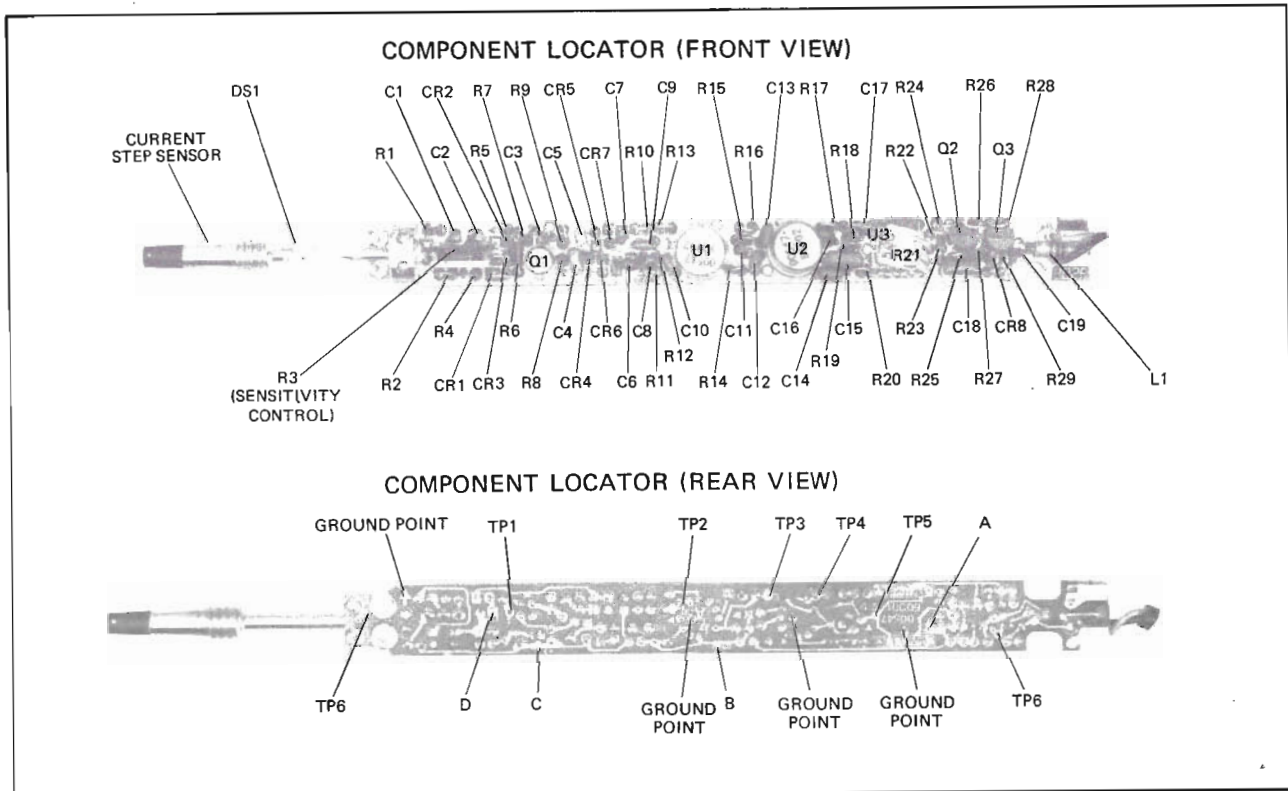

Part of Figure 9. Schematic Diagram

NOTES

1. Reference designations within this assembly are abbreviated. Add assembly number to abbreviation for complete description.
2. Unless otherwise indicated:
 - Resistance in ohms;
 - Capacitance in farads;
 - Inductance in henries.
3. "●" indicates short lead at component end to be placed on PC board.
4. Voltage and current measurements taken under the following conditions:
 - a. Ambient temperature range 65°F to 85°F.
 - b. Power supply adjusted to give 5.00 Vdc at Test Point \oplus .
 - c. Trimmer R21 adjusted to give 4.00 Vdc at Test Point \textcircled{A} .
5. If a measured value falls slightly out of the specified range it does not necessarily indicate a malfunction. However, the area might be suspect if the tracer is not working properly.
6. Single line, double line, and boxed values are used at various points on the schematic to give troubleshooting data. These values are defined as follows:
 - a. A single line specification, e.g., 1.4—1.6 Vdc indicates measurement to be made at any setting of SENSITIVITY control.
 - b. A double line specification, e.g., $\frac{31 \rightarrow 35 \text{ mA}}{27 \rightarrow 31 \text{ mA}}$ indicates measurement to be made with the sensitivity control in the most sensitive position for the upper value and the least sensitive position for lower value.
 - c. A value shown in a box, e.g., $\boxed{4.8 \rightarrow 5.0 \text{ Vdc}}$ indicates measurement is to be made with sufficient stimulus present to light indicator to full brightness.
7. Numbered points, i.e., $\textcircled{3}$, on the PC board, designate the signal output of block sections on schematic. Refer to waveforms. Lettered points, i.e., \textcircled{C} , on the PC board, indicate dc level points.
8. Circuits marked with shaded overlay, i.e., ■ if grounded, and power supply is not current-limited, could result in destruction of Q2, Q3, L1 and CR8.
9. The broken lines, i.e., - - - - , are feedback paths.
10. Heavy black lines, i.e., — indicate path of signal flow.

Figure 9
SCHEMATIC DIAGRAM

(See Page 13)

CERTIFICATION

Hewlett-Packard Company certifies that this instrument met its published specifications at the time of shipment from the factory. Hewlett-Packard Company further certifies that its calibration measurements are traceable to the United States National Bureau of Standards, to the extent allowed by the Bureau's calibration facility, and to the calibration facilities of other International Standards Organization members.

WARRANTY AND ASSISTANCE

This Hewlett-Packard product is warranted against defects in materials and workmanship for a period of one year from the date of shipment. Hewlett-Packard will, at its option, repair or replace products which prove to be defective during the warranty period provided they are returned to Hewlett-Packard, and provided the preventive maintenance procedures in this manual are followed. Repairs necessitated by misuse of the product are not covered by this warranty. NO OTHER WARRANTIES ARE EXPRESSED OR IMPLIED, INCLUDING, BUT NOT LIMITED TO, THE IMPLIED WARRANTIES OF MERCHANTABILITY AND FITNESS FOR A PARTICULAR PURPOSE. HEWLETT-PACKARD IS NOT LIABLE FOR CONSEQUENTIAL DAMAGES.

Service contracts or customer assistance agreements are available for Hewlett-Packard products.

For any assistance, contact your nearest Hewlett-Packard Sales and Service Office. Addresses are provided at the back of this manual.

CURRENT TRACER

547A

OPERATING AND SERVICE MANUAL

SERIAL NUMBER: A00051 and above

This manual refers directly to Model 547A Current Tracers with Serial numbers A00051.

NEWER INSTRUMENTS

The changes in Current Tracers with Serial numbers higher than A00051 are described in "Change Sheets" included with the manual.

Copyright HEWLETT-PACKARD COMPANY 1976
5301 STEVENS CREEK BLVD., SANTA CLARA, CALIF. 95050

Printed: JAN 1978

Manual Part No. 00547-90006
Microfiche Part No. 00547-90007

Printed in U.S.A.



**HEWLETT
PACKARD**

TABLE OF CONTENTS

Title	Page
Scope of Manual	1
Description	1
Instrument Identification	1
Specifications	2
Applications	2
Unpacking and Inspection	2
Storage and Shipment	2
Operating Characteristics	3
Current Tracer Operation	3
Theory of Operation	6
Maintenance	7
Performance Tests	8

LIST OF TABLES

Table	Page
1. Model 547A Current Tracer Specifications	2
2. Replaceable Parts List	10
3. Manufacturers Code List	12

LIST OF FIGURES

Figure	Page
1. HP Model 547A Current Tracer	1
2. Wire-AND Node Fault	4
3. Gate-to-Gate Faults	4
4. Solder-Bridge in Printed-Circuit	5
5. Multiple Gate Inputs	5
6. Exploded View of Current Tracer	7
7. Setup for 1 mA Test	9
8. Setup for 1 A Test	10
9. Schematic Diagram	13

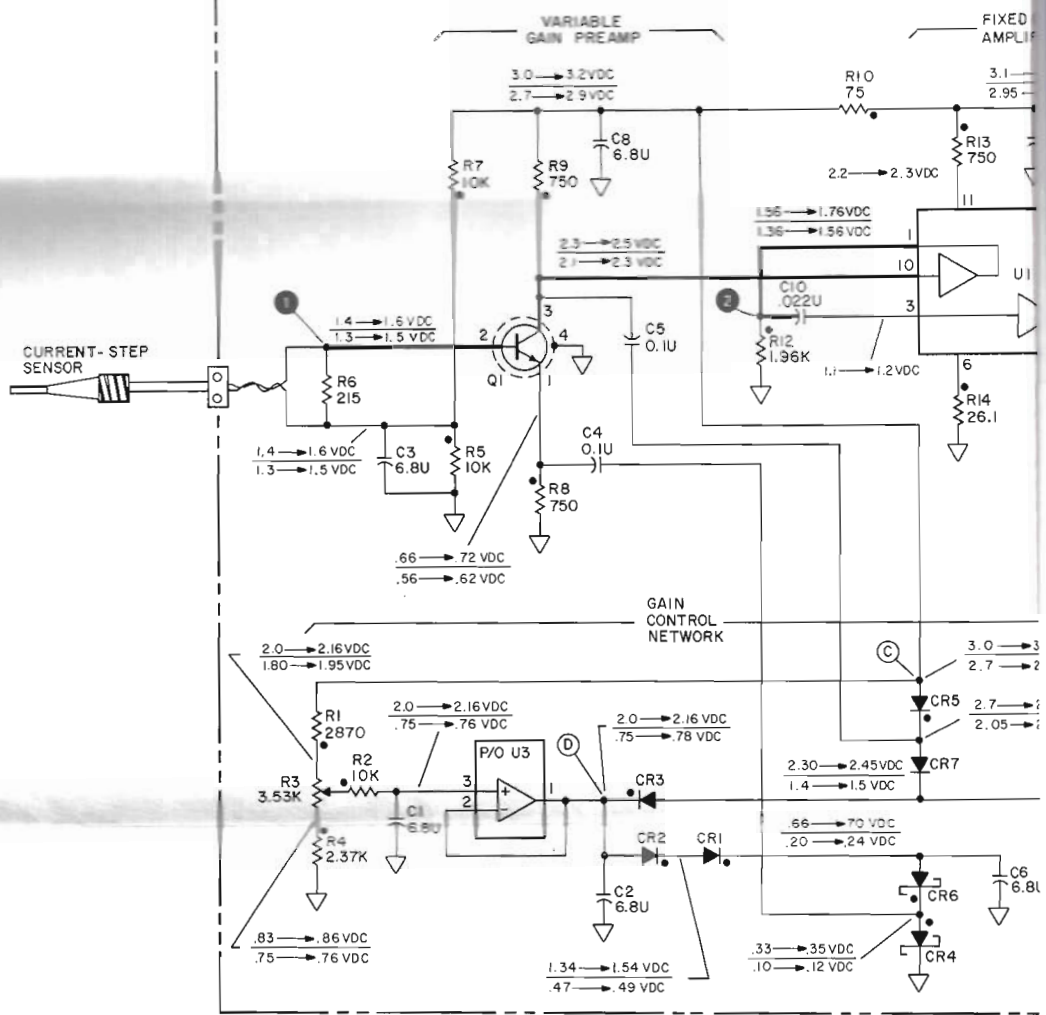

1 10 mV/cm, 5 μ sec/cm
 PULSE PERIOD (PP) = 34.5 μ sec
 SQW = 5.0V
 (SQW=SQUAREWAVE)

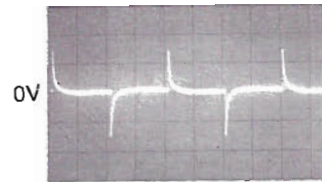

2 50 mV/cm, 5 μ sec/cm
 PULSE PERIOD (PP) = 34 μ sec
 SQW = 5.0V

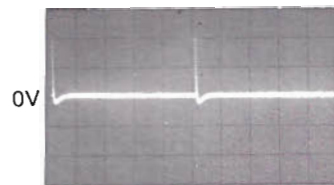

5 100 mV/cm, 5 msec/cm
 PULSE PERIOD (PP) = 60 msec
 SQW = 5.0V

6

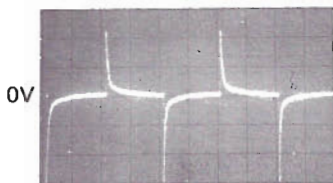
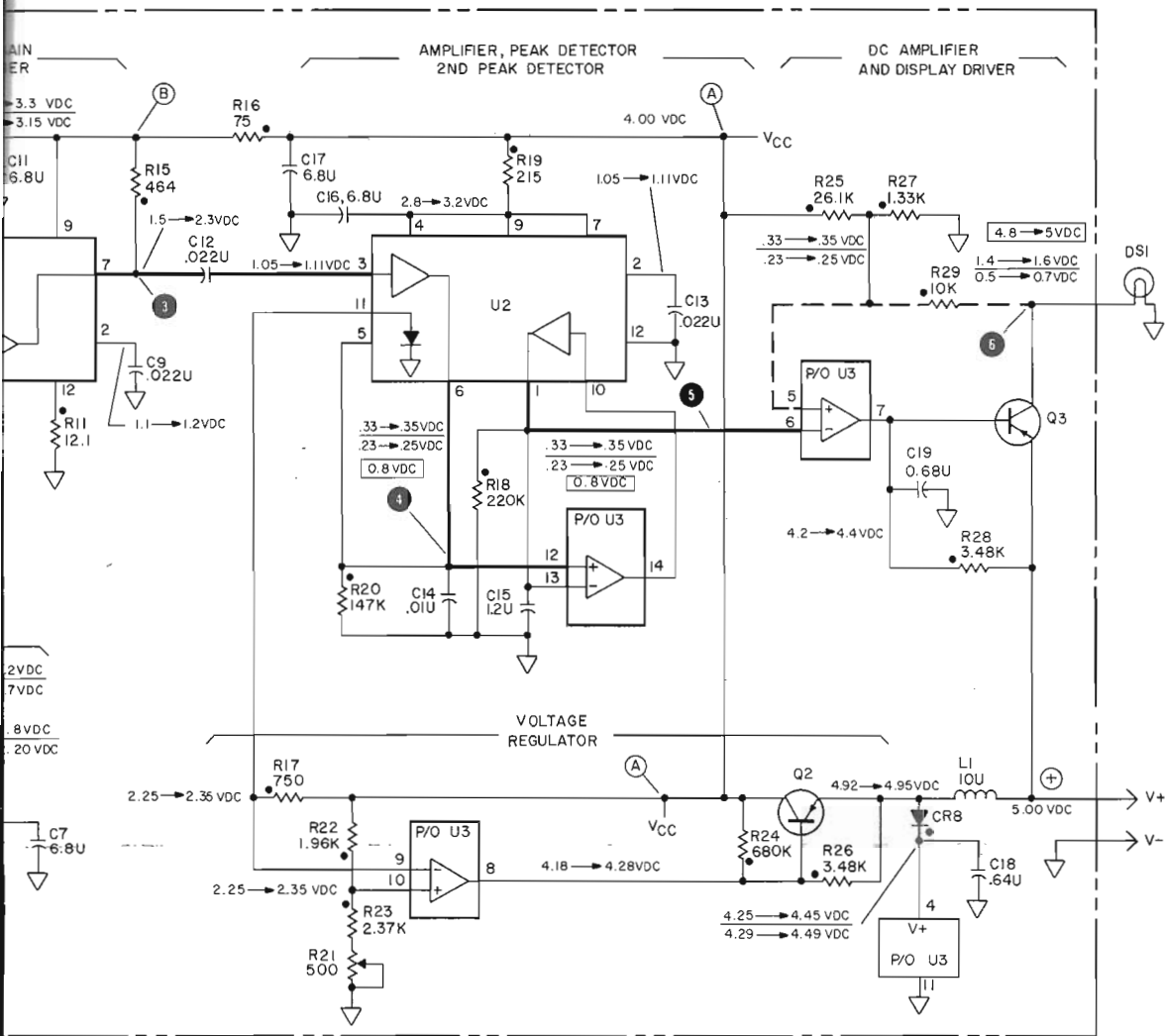

3 100 mV/cm, 5 μsec/cm
PULSE PERIOD (PP) = 34.5 μsec
SQW = 5.0V

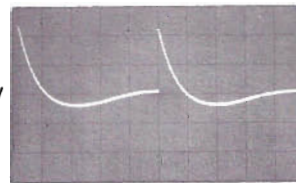

4 200 mV/cm, 0.2 msec/cm
PULSE PERIOD (PP) = 3.3 msec
SQW = 5.0V



200 mV/cm, 1 msec/cm
PULSE PERIOD (PP) = 60 msec
SQW = 5.0V

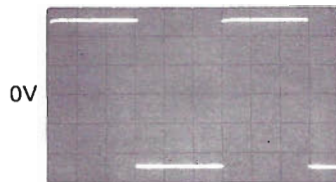

5 6 INPUT (for test points 5 and 6)
1V/cm, 10 μsec/cm

Model 547A
Figure 9. Schematic Diagram