HP 3458A Multimeter

HP 3458A Assembly Level Repair Manual

This manual applies to HP 3458As with a serial number prefix of:

2823A and Above

WARNING

The information in this manual is to be used by qualified service-trained personnel only. To avoid personal injury, do not perform any procedure explained in this manual, or perform any servicing of the HP 3458A unless you are qualified to do so.



Copyright © Hewlett-Packard Company, 1988

Manual Part Number: 03458-90010
Microfiche Part Number: 03458-99010

Printed: SEPTEMBER 1988 Edition 1
Printed in U.S.A. U0988

Printing History

The Printing History shown below lists the printing dates of all Editions and Updates created for this manual. The Edition number changes as the manual undergoes subsequent revisions. Editions are numbered sequentially starting with Edition 1. Updates, which are issued between Editions, contain individual replacement pages which the customer uses to update the current Edition of the manual. Updates are numbered sequentially starting with Update 1. Each new Edition or Update also includes a revised copy of this printing history page.

Many product updates and revisions do not require manual changes and, conversely, manual corrections may be done without accompanying product changes. Therefore, do not expect a one-to-one correspondence between product updates and manual updates.

Edition 1 (Part Number 03458-90010) SEPTEMBER 1988

RESTRICTED RIGHTS LEGEND

Use, duplication, or disclosure by the Government is subject to restrictions as set forth in subdivision (b)(3)(ii) of the Rights in Technical Data and Computer Software clause at 52.227-7013.

Hewlett-Packard Company
3000 Hanover Street, Palo Alto, California 94304

Herstellerbescheinigung

Hiermit wird bescheinigt, daß das Gerät/System HP 3458A
in Übereinstimmung mit den Bestimmungen von Postverfügung 1046/84 funkentstört ist.

Der Deutschen Bundespost wurde das Inverkehrbringen dieses Gerätes/Systems angezeigt und die Berechtigung zur Überprüfung der Serie auf Einhaltung der Bestimmungen eingeräumt.

Zusatzinformation für Meß- und Testgeräte

Werden Meß- und Testgeräte mit ungeschirmten Kabeln und/oder in offenen Meßaufbauten verwendet, so ist vom Betreiber sicherzustellen, daß die Funk-Entstörbestimmungen unter Betriebsbedingungen an seiner Grundstücksgrenze eingehalten werden.

Manufacturer's declaration

This is to certify that the equipment HP 3458A
is in accordance with the Radio Interference Requirements of Directive FTZ 1046/84. The German Bundespost was notified that this equipment was put into circulation, the right to check the series for compliance with the requirements was granted.

Additional Information for Test and Measurement Equipment

If Test- and Measurement Equipment is operated with unscreened cables and/or used for measurements on open set-ups, the user has to assure that under operating conditions the Radio Interference Limits are still met at the border of his premises.

NOTICE

The information contained in this document is subject to change without notice.

HEWLETT-PACKARD MAKES NO WARRANTY OF ANY KIND WITH REGARD TO THIS MATERIAL, INCLUDING, BUT NOT LIMITED TO, THE IMPLIED WARRANTIES OF MERCHANTABILITY AND FITNESS FOR A PARTICULAR PURPOSE. Hewlett-Packard shall not be liable for errors contained herein or for incidental or consequential damages in connection with the furnishing, performance or use of this material.

Hewlett-Packard assumes no responsibility for the use or reliability of its software on equipment that is not furnished by Hewlett-Packard.

This document contains proprietary information which is protected by copyright. All rights are reserved. No part of this document may be photocopied, reproduced or translated to another language without the prior written consent of Hewlett-Packard Company.



CERTIFICATION

Hewlett-Packard Company certifies that this product met its published specifications at the time of shipment from the factory. Hewlett-Packard further certifies that its calibration measurements are traceable to the National Institute of Standards and Technologies, to the extent allowed by the the Institute's calibration facility, and to the calibration facilities of other International Standards Organization members.

WARRANTY

This Hewlett-Packard instrument product is warranted against defects in materials and workmanship for a period of one year from date of shipment. During the warranty period, Hewlett-Packard Company will, at its option, either repair or replace products which prove to be defective.

For warranty service or repair, this product must be returned to a service facility designated by -hp-. Buyer shall prepay shipping charges to -hp- and -hp- shall pay shipping charges to return the product to Buyer. However, Buyer shall pay all shipping charges, duties, and taxes for products returned to -hp- from another country.

Duration and conditions of warranty for this instrument may be superceded when the instrument is integrated into (becomes a part of) other -hp- instrument products.

Hewlett-Packard warrants that its software and firmware designated by -hp- for use with an instrument will execute its programming instructions when properly installed on that instrument. Hewlett-Packard does not warrant that the operation of the instrument, or software, or firmware will be uninterrupted or error free.

LIMITATION OF WARRANTY

The foregoing warranty shall not apply to defects resulting from improper or inadequate maintenance by Buyer, Buyer-supplied software or interfacing, unauthorized modification or misuse, operation outside of the environmental specifications for the product, or improper site preparation or maintenance.

NO OTHER WARRANTY IS EXPRESSED OR IMPLIED. HEWLETT-PACKARD SPECIFICALLY DISCLAIMS THE IMPLIED WARRANTIES OF MERCHANTABILITY AND FITNESS FOR A PARTICULAR PURPOSE.

EXCLUSIVE REMEDIES

THE REMEDIES PROVIDED HEREIN ARE BUYER'S SOLE AND EXCLUSIVE REMEDIES. HEWLETT-PACKARD SHALL NOT BE LIABLE FOR ANY DIRECT, INDIRECT, SPECIAL, INCIDENTAL, OR CONSEQUENTIAL DAMAGES, WHETHER BASED ON CONTRACT, TORT, OR ANY OTHER LEGAL THEORY.

ASSISTANCE

Product maintenance agreements and other customer assistance agreements are available for Hewlett-Packard products.

For any assistance, contact your nearest Hewlett-Packard Sales and Service Office. Addresses are provided at the back of this manual.



SAFETY SUMMARY

The following general safety precautions must be observed during all phases of operation, service, and repair of this instrument. Failure to comply with these precautions or with specific warnings elsewhere in this manual violates safety standards of design, manufacture, and intended use of the instrument. Hewlett-Packard Company assumes no liability for the customer's failure to comply with these requirements.

GROUND THE INSTRUMENT

To minimize shock hazard, the instrument chassis and cabinet must be connected to an electrical ground.

DO NOT OPERATE IN AN EXPLOSIVE ATMOSPHERE

Do not operate the instrument in the presence of flammable gases or fumes. Operation of any electrical instrument in such an environment constitutes a definite safety hazard.

KEEP AWAY FROM LIVE CIRCUITS

Operating personnel must not remove instrument covers. Component replacement and internal adjustments must be made by qualified maintenance personnel. Under certain conditions, dangerous voltages may exist even with the instrument switched off. To avoid injuries, always disconnect input voltages and discharge circuits before touching them.

DO NOT SERVICE OR ADJUST ALONE

Do not attempt internal service or adjustment unless another person, capable of rendering first aid and resuscitation, is present.

DO NOT SUBSTITUTE PARTS OR MODIFY INSTRUMENT

Because of the danger of introducing additional hazards, do not install substitute parts or perform any unauthorized modification to the instrument. Return the instrument to a Hewlett-Packard Sales and Service Office for service and repair to ensure that safety features are maintained.

DO NOT OPERATE A DAMAGED INSTRUMENT

Whenever it is possible that the safety protection features built into this instrument have been impaired, either through physical damage, excessive moisture, or any other reason, REMOVE POWER and do not use the instrument until safe operation can be verified by service-trained personnel. If necessary, return the instrument to a Hewlett-Packard Sales and Service Office for service and repair to ensure that safety features are maintained.



Operating and Safety Symbols

Symbols Used On Products And In Manuals

~ LINE AC line voltage input receptacle.



Instruction manual symbol affixed to product. Cautions the user to refer to respective instruction manual procedures to avoid possible damage to the product.



Indicates dangerous voltage – terminals connected to interior voltage exceeding 1000 volts.

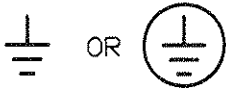

OR



Protective conductor terminal. Indicates the field wiring terminal that must be connected to earth ground before operating equipment – protects against electrical shock in case of fault.



Clean ground (low-noise). Indicates terminal that must be connected to earth ground before operating equipment – for single common connections and protection against electrical shock in case of fault.

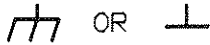

OR



Frame or chassis ground. Indicates equipment chassis ground terminal – normally connects to equipment frame and all metal parts.



Affixed to product containing static sensitive devices – use anti-static handling procedures to prevent electrostatic discharge damage to components.

NOTE

NOTE

Calls attention to a procedure, practice, or condition that requires special attention by the reader.

CAUTION

CAUTION

Calls attention to a procedure, practice, or condition that could possibly cause damage to equipment or permanent loss of data.

WARNING

WARNING

Calls attention to a procedure, practice, or condition that could possibly cause bodily injury or death.

Contents

(A more detailed table of contents is at the beginning of each section)

Section 1 General Information

INTRODUCTION	1
MANUAL DESCRIPTION	1
INSTRUMENT DESCRIPTION	2
SAFETY CONSIDERATIONS	2
INSTRUMENT IDENTIFICATION	2
TOOLS AND EQUIPMENT REQUIRED	3

Section 2 Operating Information

INTRODUCTION	1
BEFORE APPLYING POWER	1
APPLYING POWER	2
OPERATING FROM THE FRONT PANEL	4
OPERATING FROM REMOTE	16

Section 3 Disassembly/Assembly Procedures and Parts List

INTRODUCTION	1
STATIC HANDLING	1
CLEAN HANDLING	2
PRINTED CIRCUIT ASSEMBLY IDENTIFICATION	2
COVERS REMOVAL/INSTALLATION PROCEDURES	3
ASSEMBLIES REMOVAL/INSTALLATION PROCEDURES	8
REPLACEABLE PARTS	30

Section 4 Assembly Level Troubleshooting

INTRODUCTION	1
TEST EQUIPMENT REQUIRED	1
HP 3458A ADJUSTMENTS/CALIBRATION	1
ASSEMBLIES REMOVAL/INSTALLATION PROCEDURES	2
HP 3458A TECHNICAL DESCRIPTION	2
ASSEMBLY LEVEL TROUBLESHOOTING	6
POWER SUPPLIES TROUBLESHOOTING	13

Contents

Section 1 General Information

INTRODUCTION	1
MANUAL DESCRIPTION	1
INSTRUMENT DESCRIPTION	2
SAFETY CONSIDERATIONS	2
INSTRUMENT IDENTIFICATION	2
TOOLS AND EQUIPMENT REQUIRED	2
Tools Required	2
Test Equipment Required	3

SECTION 1

GENERAL INFORMATION

INTRODUCTION

This manual has information to perform assembly level troubleshooting of the HP 3458A Multimeter. Included are the removal/installation procedures of the instrument's printed circuit board assemblies, and a parts list. This manual is intended for use by service trained personnel only. Operating and programming personnel should refer to the HP 3458A Multimeter Operating, Programming, and Configuration Manual.

Detailed operating and programming information is excluded from this manual. Only sufficient information for service purposes is included. For more detailed operating and programming information, refer to the HP 3458A Multimeter Operating, Programming, and Configuration Manual.

WARNING

The information in this manual is for the use of Service Trained Personnel only. To avoid electrical shock, do not perform any procedures in this manual or do any servicing to the HP 3458A, unless you are qualified to do so.

MANUAL DESCRIPTION

This manual is separated into the four following sections.

Section 1 -- General Information

Section 1 contains a brief description of the instrument and other general information.

Section 2 -- Operating Instructions

Section 2 summarizes instrument operation geared for service trained personnel. Only service related commands are summarized. For more operating information, refer to the HP 3458A Multimeter Operating, Programming, and Configuration Manual.

Section 3 -- Removal/Installation Procedures and Mechanical Parts List

Section 3 has the removal/installation procedures for the HP 3458A Printed Circuit Board Assemblies. The section also has a mechanical parts list.

Section 4 -- Assembly Level Troubleshooting

Section 4 contains a block diagram theory of operation and assembly level troubleshooting information.

INSTRUMENT DESCRIPTION

The HP 3458A is a high precision digital multimeter that can measure AC and DC volts, AC and DC current, AC+DC volts, AC+DC current, resistance, period, and frequency. It can also perform complex math calculations.

The multimeter has a maximum reading rate of 100,000 readings/sec. The maximum input voltage is 1000 V and the resolution is from 4 1/2 to 8 1/2 digits.

The HP 3458A has a digitizing function that converts continuous analog signals into discrete samples.

All instrument functions are selectable from the front panel or remotely over the Hewlett-Packard Interface Bus (HP-IB).

SAFETY CONSIDERATIONS

The HP 3458A is a safety class 1 instrument provided with a protective earth terminal. The instrument and manuals should be reviewed for safety markings and instructions before operation. Refer to the Safety Summary preceding this section for appropriate safety instructions and markings covering the instrument.

INSTRUMENT IDENTIFICATION

Hewlett-Packard instruments are identified by a two part, ten digit serial number. The serial number is located on the instrument's rear panel between the rear terminals and fan filter. The number is in the form 0000A00000. The first four digits, called the serial number prefix, is the same for all identical instruments. It changes only when a change is made to the instrument. The letter indicates the country of origin (*A* indicates the instrument was built in the United States of America). The last five digits, called the serial number suffix, are unique for each instrument.

Be sure to include the entire serial number, both prefix and suffix, in any correspondence about your instrument.

TOOLS AND EQUIPMENT REQUIRED

Tools Required

You need the following tools for instrument covers removal and installation.

1. #1 Pozidriv screwdriver.
2. #TX15 Torx driver.
3. #TX10 Torx driver.

You need the following tools for the printed circuit board assemblies removal/installation procedures.

1. #1 Pozidriv screwdriver.
2. #TX10 Torx driver.
3. 6 millimeter nut driver (for A/D Converter assembly only).
4. 7 millimeter nut driver (for Outguard Controller assembly only)
5. Small flat bladed screwdriver (for Display Logic assembly only)
6. Large screwdriver (e.g., #2 Pozidriv; for Display Logic assembly only)

Test Equipment Required

You need the following to troubleshoot the HP 3458A.

1. 4 1/2 digit digital multimeter that can measure +5 V, +18 V, and -18 V DC.
2. Computer with HP-IB capability (for HP-IB failures only).
3. Logic Probe or Oscilloscope than can measure a 1 μ S 5 V pulse (for Ext Out failures only).

Contents

Section 2 Operating Information

INTRODUCTION	1
BEFORE APPLYING POWER	1
APPLYING POWER	2
Power-On Self Test	2
The Display	3
OPERATING FROM THE FRONT PANEL	4
Making a Measurement	4
Changing the Measurement Function	5
Autoranging and Manual Ranging	5
Hold	5
Manual Ranging	6
Self-Test	7
Reading the Error Register	7
Resetting the Multimeter	8
Using the Configuration Keys	9
Selecting a Parameter	10
Default Values	10
Numeric Parameters	11
Exponential Parameters	11
Multiple Parameters	12
Using the MENU keys	12
Query Commands	13
Standard Queries	13
Additional Queries	13
Display Control	14
Clearing the Display	14
Display Editing	14
Viewing Long Displays	15
MORE INFO Display	15
Digits Displayed	15
Recall	16
OPERATING FROM REMOTE	16
Input/Output Statements	16
Reading the HP-IB Address	16
Changing the HP-IB Address	17
Sending a Remote Command	17
Getting Data from the Multimeter	17
The Local Key	18

1
2
3
4
5
6
7
8
9
10
11
12
13
14
15
16
17
18
19
20
21
22
23
24
25
26
27
28
29
30
31
32
33
34
35
36
37
38
39
40
41
42
43
44
45
46
47
48
49
50
51
52
53
54
55
56
57
58
59
60
61
62
63
64
65
66
67
68
69
70
71
72
73
74
75
76
77
78
79
80
81
82
83
84
85
86
87
88
89
90
91
92
93
94
95
96
97
98
99
100

1

2

3

SECTION 2

OPERATING INFORMATION

INTRODUCTION

This section summarizes the HP 3458A operating information. The HP 3458A Multimeter Operating, Programming, and Configuration Manual has the complete operating information.

BEFORE APPLYING POWER

- Make sure the line voltage selection switches on the multimeter's rear panel are set to match the local line voltage. Refer to Table 2-1 and Figure 2-1 for the proper switch positions.
- Make sure the proper line fuse is installed. Refer to Table 2-1 for the proper line fuse.
- Make sure the proper power cord is used. Refer to Figure 2-2 for the proper power cord.

Table 2-1. Line Voltage Limits and Line Fuses

Nominal Value (RMS)	Allowable limits (RMS)	Fuse	Fuse Part #
100 VAC	90 VAC to 110 VAC	1.5A 250V NTD FE UL	2110-0043
120 VAC	105 VAC to 132 VAC	1.5A 250V NTD FE UL	2110-0043
220 VAC	198 VAC to 242 VAC	0.5A 250V TD FE UL	2110-0202
240 VAC	216 VAC to 250 VAC	0.5A 250V TD FE UL	2110-0202

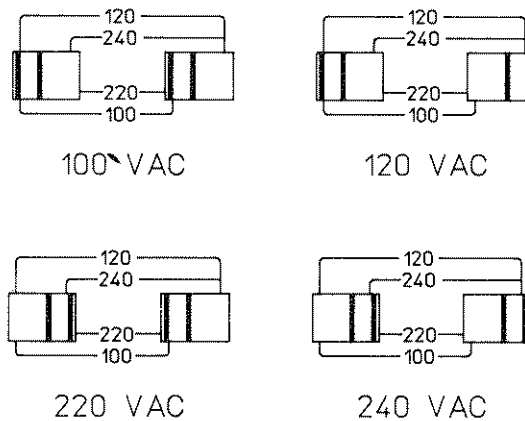

(ME10)34580PDF.1.2

Figure 2-1. AC Line Voltage Switch Positions

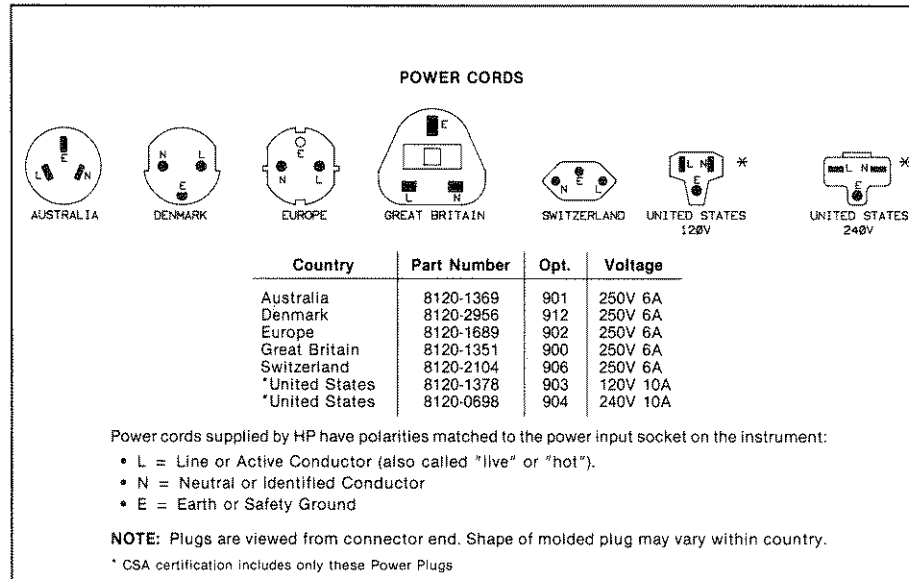

Figure 2-2. Power Cords

APPLYING POWER

To turn on the multimeter, depress the front panel **Power** switch. If the multimeter does not appear to turn on, verify that the multimeter is connected to line power. If line power is not the problem, remove the power cord and check the line power fuse and the line voltage selection switch settings.

Power-On Self Test

When power is applied, the multimeter performs a limited power-on self-test. This test verifies that the multimeter is operating but does not necessarily verify that measurements will be accurate.

When the power-on self-test is finished, the multimeter beeps once, automatically triggers, automatically selects the range, and performs DC voltage measurements. Also, the multimeter has many of its commands set to pre-defined power-on values as shown in Table 2-2. This is called the power-on state.

If during the power-on self-test a failure is detected, the HP 3458A turns on the **ERR** annunciator (located in the display). Use the explanation in the "Reading the Error Register" paragraph to determine what the error is. If the error is a hardware error, go to Section 4 of this manual for troubleshooting.

In most cases, only the **ERR** annunciator is turned on and the instrument remains in the error condition. In other cases, an error message may be displayed and the instrument locks up. In this case, go to Section 4 of this manual for troubleshooting.

Table 2-2. Power-On State

Command	Description
ACBAND 20,2E6	AC Bandwidth 20Hz - 2MHz
AZERO ON	Autozero enabled
DCV AUTO	DC Voltage, autorange
DEFEAT OFF	Defeat disabled
DELAY -1	Default delay
DISP ON	Display enabled
EMASK 32767	Enable all error conditions
END OFF	Disable HP-IB EOI function
EXTOUT ICOMP,NEG	Input complete EXTOUT signal, negative pulse
FIXEDZ OFF	Disable fixed input resistance
FSOURCE ACV	Frequency and period source is AC voltage
INBUF OFF	Disable input buffer
LEVEL 0,ACV	Level trigger at 0%, AC-coupled
LFILTER OFF	Level filter disabled
LOCK OFF	Keyboard enabled
MATH OFF	Disable real-time math
MEM OFF	Disable reading memory (last memory operation = FIFO)
MFORMAT SREAL	Single real reading memory format
MMATH OFF	Disable post-process math
NDIG 7	Display 7.5 digits
NPLC 10	10 power line cycles of integration time
NRDGS 1,AUTO	1 reading per trigger, auto sample event
OCOMP OFF	Disable offset compensated resistance
OFORMAT ASCII	ASCII output format
QFORMAT NORM	Normal query format
RATIO OFF	Disable ratio measurement
SETACV ANA	Analog AC voltage mode
SLOPE POS	Positive slope for level triggering
TARM AUTO	Auto trigger arm event
TBUFF OFF	Disable external trigger buffering
TIMER 1	1 second timer interval
TRIG AUTO	Auto trigger event

At power-on, all math registers are set to 0 except:

DEGREE = 20
SCALE = 1
PERC = 1
REF = 1
RES = 50

The Display

In the power-on state, the display is continuously updated with each new DC voltage reading. Along the bottom of the display are a series of annunciators. These annunciators alert you to a variety of conditions. For example, the **SMPL** annunciator flashes whenever the multimeter has completed a reading. Table 2-3 describes the meaning of each display annunciator.

Table 2-3. Display Annunciators

Display Annunciator	Description
SMPL	Flashes whenever a reading is completed
REM	The multimeter is in the HP-IB remote mode
SRQ	The multimeter has generated an HP-IB service request
TALK	The multimeter is addressed to talk on HP-IB
LSTN	The multimeter is addressed to listen on HP-IB
AZERO OFF	Autozero is disabled
MRNG	Autorange is disabled (the multimeter is using a fixed range)
MATH	One or two real-time or post-process math operations enabled
ERR	An error has been detected
SHIFT	The shift key has been pressed
More INFO	More information concerning the present configuration is available (use the right arrow key to view the information)

OPERATING FROM THE FRONT PANEL

The following shows how to make a simple DC voltage measurement, how to use the various front panel keys, and describes the multimeter functions important to front panel operation. Figure 2-3 shows the multimeter's front panel features.

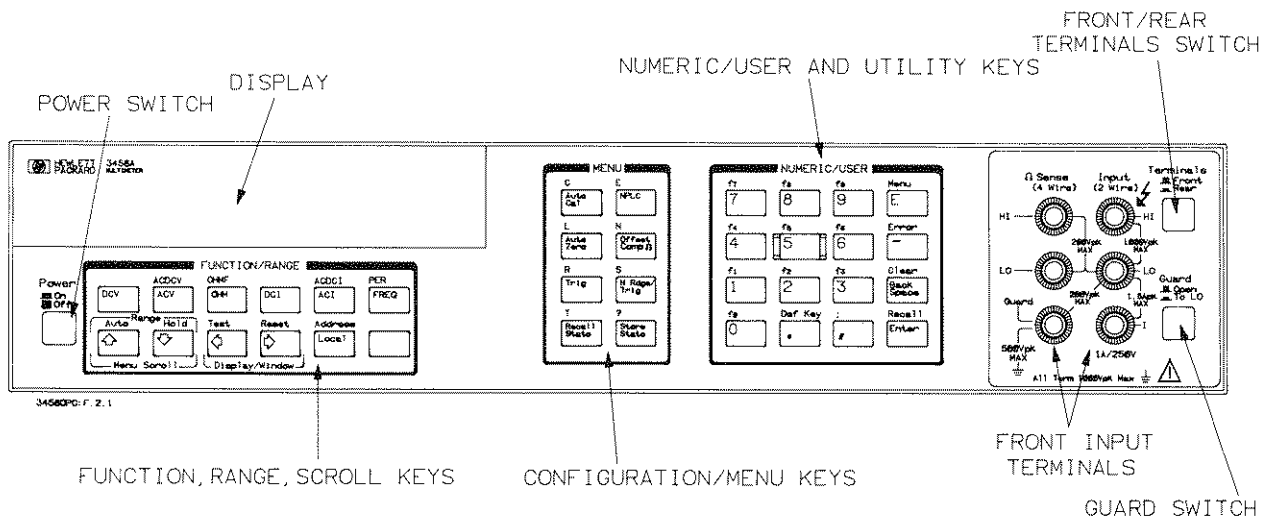

Figure 2-3. Front Panel

Making a Measurement

In the power-on state, DC voltage measurements are selected and the multimeter automatically triggers and selects the range. In the power-on state, you can make DC voltage measurements simply by connecting a DC voltage to the input terminals as shown in Figure 2-4. The connections shown in Figure 2-4 also apply for AC voltage, 2-wire resistance, AC+DC voltage, digitizing, and frequency or period measurements from a voltage input source.

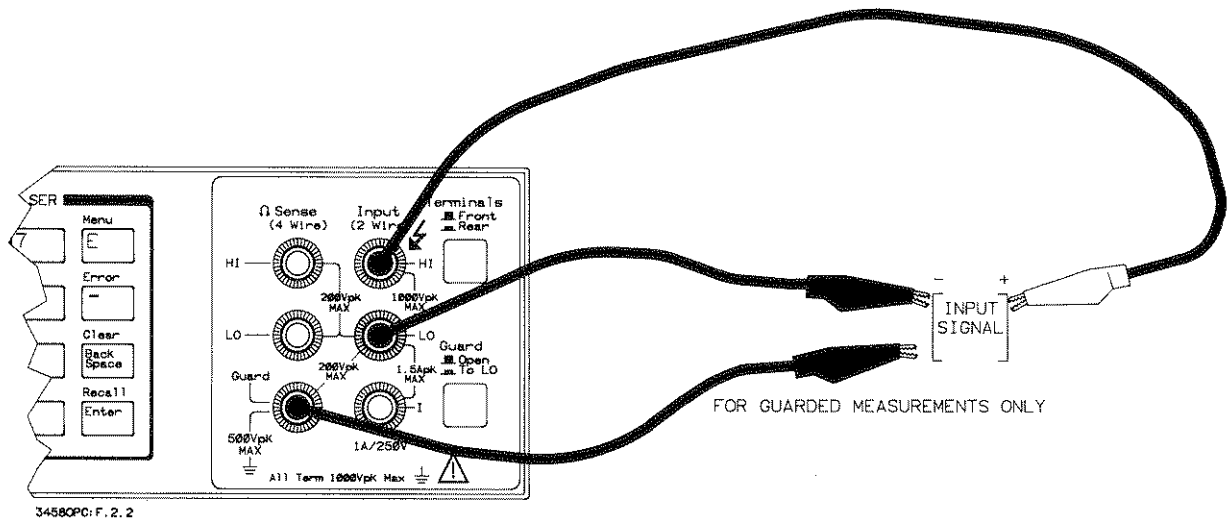

Figure 2-4. Standard 2-Wire (Plus Guard) Measurements

Changing the Measurement Function

The row of keys located directly under the display (**FUNCTION** keys) select the multimeter's standard measurement functions. Table 2-4. shows the **FUNCTION** keys and the measurement function selected by each.

In addition to the functions selected by the **FUNCTION** keys, the multimeter can perform direct-sampled or sub-sampled digitizing, ratio measurements, and AC or AC+DC voltage measurements using the synchronous or random measurement methods. These functions can be selected from the front panel by accessing the appropriate command(s) using the alphabetic menu keys (these keys are discussed later in this section under "Using the MENU Keys").

Autoranging and Manual Ranging

In the power-on state, the multimeter automatically selects the appropriate measurement range. This is called autorange. In many cases, you will probably want to continue using autorange. However, you have two other ranging choices: hold and manual ranging.





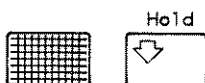









Hold

This choice allows you to shut off autoranging. To do this, let autorange choose a range and then press:



Notice the display's **MRNG** (manual range) annunciator is on. This annunciator is on whenever you are not using autorange.

Table 2-4. FUNCTION Keys

KEY	DESCRIPTION
	DC VOLTAGE MEASUREMENT
	AC VOLTAGE MEASUREMENT
	2-WIRE RESISTANCE MEASUREMENT
	AC CURRENT MEASUREMENT
	DC CURRENT MEASUREMENT
	FREQUENCY MEASUREMENT
 ACDCV 	DC+DC VOLTAGE MEASUREMENT
 OHMF 	4-WIRE RESISTANCE MEASUREMENT
 ACDCI 	DC+DC CURRENT MEASUREMENT
 PER 	PERIOD MEASUREMENT

F. 2. 4

Manual Ranging

The second choice lets you manually select the range. When the multimeter is in the measurement mode (that is, the multimeter is making and displaying measurements or the display is showing OVL D) you can change the range by pressing the up or down arrow keys. To go to a higher range, press:



By repeatedly pressing the up arrow key, you can increment up to the highest range. When you reach the highest range, pressing the up arrow key no longer changes the range. To go to a lower range, press:



By repeatedly pressing the down arrow key, you can decrement down to the lowest range. When you reach the lowest range, pressing the down arrow key no longer changes the ranges. To return to auto-ranging, press:

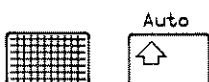

Self-Test

The HP 3458A self-test is similar to the power-on self-test, but performs more hardware and accuracy tests. The tests are different enough that a failure may be detected by one test, but not the other.

Always disconnect any input signals before you run self-test. If you leave an input signal connected to the multimeter, it may cause a self-test failure.

The self-test takes over 50 seconds. To run self-test press:



If the self-test passed, the display shows:

```
SELF TEST PASSED
```

When self-test passes, you have a high confidence that the multimeter is operational and, assuming proper calibration and autocalibration, that measurements will be accurate.

If any of the tests failed, the **ERR** annunciator illuminates and the display shows:

```
SELF TEST FAILED
```

If the self-test failed, one or more error conditions have been detected. Refer to the next paragraph "Reading the Error Register".

Reading the Error Register

Whenever the display's **ERR** annunciator is illuminated, one or more errors have been detected. A record of hardware errors are stored in the auxiliary error register. Programming and syntax errors are stored in the error register.

The errors stored in the error registers consist of two parts: an error number and a corresponding error message that explains the error. All hardware errors have a "200" series number.

To read the registers, press:



The lowest numbered error and a description of the error is displayed. For example, a possible error message is:

```
209,"HARDWARE FAILURE -  
INTERNAL OVERLOAD: 101"
```

Only part of the message is displayed by the instrument. To view the entire message, use the right arrow key.

If the **ERR** annunciator is still illuminated, more errors have been recorded. Repeat the above key sequence until all errors have been read and the **ERR** annunciator is no longer illuminated. When all errors are read, the error annunciator goes off. If you try to read another error, the display shows:

0,"NO ERROR"

You do not have to run self-test to get an error. The multimeter detects errors that occur while entering data, when changing functions or ranges, and so on. The multimeter beeps whenever it detects an error.

Whenever you want to clear information (such as an error description) from the display and return it to displaying measurements, press:



You can also clear the display by repeatedly pressing the **Back Space** key (unshifted).

Resetting the Multimeter

Many times during operation, you may wish to return to the power-on state. The front panel **Reset** key returns you to the power-on state without having to cycle the multimeter's power. To reset the multimeter, press:



The multimeter begins the reset process with a display test which illuminates all display elements including the annunciators, as shown in Figure 2-5. (By holding down the **Reset** key, the multimeter continuously performs its display test).

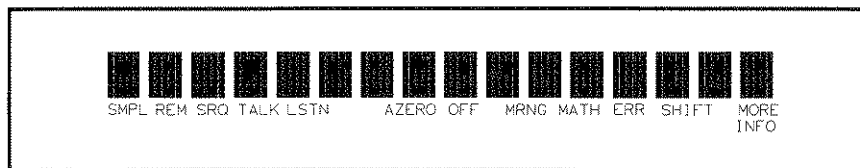

Figure 2-5. Display Test









Pressing the shifted front panel **Reset** key performs the power-on sequence which has the same effect as cycling the multimeter's power. This destroys any stored readings and compressed subprograms, sets the power-on SRQ bit in the status register, resets the A/D converter reference frequency, and performs the power-on self-test. (These operations are discussed in detail in the HP 3458A Multimeter Operating, Programming, and Configuration Manual.)

Executing the RESET command from the alphabetic command menu (**MENU** keys) returns the multimeter to the power-on state but does not perform the power-on sequence. The **MENU** keys are discussed later in this section.

Using the Configuration Keys

The configuration keys (unshifted **MENU** keys) let you rapidly access the most frequently used multimeter features. Table 2-5 shows each key, the corresponding multimeter command, and the function of each. (These functions are discussed in detail in the HP 3458A Multimeter Operating, Programming, and Configuration Manual.)

Table 2-5. Configuration Keys Functions

Key	Command	Description
	ACAL	Performs one or all autocal routines (It takes over 11 minutes to run all of the autocal routines. Never reset the multimeter to abort an autocal. Once you start an autocal you must complete it).
	NPLC	Sets integration time in terms of power line cycles
	AZERO	Enables or disables the autozero function
	OCOMP	Enables or disables offset compensation for 2- or 4-wire resistance measurements
	TRIG	Specifies the trigger event
	NRDGS	Selects the number of readings per trigger event and the sample event
	RSTATE	Recalls a previously stored state from memory
	SSTATE	Stores the multimeter's present state in memory

The **TRIG** key is used to demonstrate how to use the configuration keys. Press:



The display shows:

TRIG █

This is the command header for the trigger command. Notice the multimeter automatically placed a space between the command and cursor.

Selecting a Parameter

For parameters that have a list of choices (non-numeric parameters), you can use the up and down arrow keys to review the choices. Press:



The display shows:

TRIG LEVEL █

Press:



The display shows:

TRIG AUTO █

When using the up or down arrow keys and you step past the last parameter choice, a wraparound occurs to the other end of the menu. If you wish to suspend triggering, press the up or down arrow key until the display shows:

TRIG HOLD █

Press:



You have now changed the trigger event from auto (power-on state) to hold.

Default Values

Most parameters have a default value. A default value is the value selected when you execute a command but do not specify a value. For example, the default value for the trigger parameter is SGL. Press:

Trig

The display shows:

TRIG ■

Press:

Enter

Note that the multimeter takes one reading and then stops (after the single trigger, the trigger event becomes HOLD regardless of the previously specified trigger event). You can enter -1 to select the default value. Press:

Trig - 1 Enter

The multimeter again takes a single reading and then stops.

Numeric Parameters

Some commands use numeric parameters, A numeric parameter is the actual value used by the multimeter. To demonstrate the numeric parameter, use the **NPLC** configuration. Press:

NPLC

The display shows:

NPLC ■

If you press the up or down arrow key, no parameter choice is displayed. This means there is no menu and you must enter a number. To enter a number, press:

1 Enter

You have now selected 1 power line cycles of integration for the A/D converter. Integration time is the actual time that the A/D converter measures an input signal.

Exponential Parameters

Numeric parameters can also be entered in exponential notation. For example, press:

NPLC 1 0 0 E - 3 Enter

You have now selected 0.1 power line cycles of integration time. At this point, reset the multimeter to return the number of power line cycles to 10 by pressing:

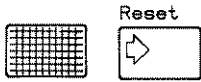

Multiple Parameters

Many commands have more than one parameter. (Multiple parameters are separated by commas.) For example, the NRDGS command has two parameters. To demonstrate, press:



The display should show:

NRDGS █

The first parameter in the NRDGS command is a numeric parameter that specifies the number of readings made per trigger event. For example, to specify 5 readings per trigger event, press:



The display shows:

NRDGS 5, █

The second parameter of the NRDGS command specifies the event that initiates each reading. Since this is not a numeric parameter, a menu is available for this parameter. Use the up or down arrow keys to cycle through the list of choices. When the display shows:

NRDGS 5, AUTO █

Execute the command by pressing:



Using the MENU keys

In addition to the configuration keys, the multimeter has an alphabetic command menu that can be accessed using the shifted MENU keys labeled C, E, L, N, R, S, and T. Each of these letters corresponds to the area you will enter into the command menu. For example, to enter the menu with commands starting with T, press:

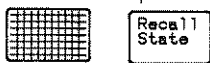

The display shows:

TARM

You can now use the **Menu Scroll** keys (up or down arrow keys) to step through the menu in alphabetical order (down arrow key) or in reverse alphabetical order (up arrow key). For example, starting with the TARM above, press the down arrow key once and the display shows the next command in alphabetical order (TBUFF). (You can also press and hold the up or down arrow key to rapidly step through the menu.) Once you have found the desired command, you can press the **Enter** key to execute it immediately (using default parameter values if applicable). If you need to specify command parameter(s), with the command displayed, press the right arrow key or the comma key (or, if the first parameter is numeric, a numeric key). This selects the command and allows you to specify or select parameter(s) using the procedures described earlier in this section.

There are two alphabetic menus available: FULL and SHORT. You can select between these menus using the shifted **Menu** key. The specified menu choice is stored in continuous memory (not lost when power is removed). The FULL menu contains all commands except query commands that can be constructed by appending a question mark to a command (e.g., BEEP, BEEP?). (Query commands are discussed next.) The SHORT menu eliminates the HP-IB bus-related commands, commands that are seldom used from the front panel, and any commands that have dedicated front panel keys (e.g., the **NPLC** key or the **Trig** key).

Query Commands

There are a number of commands in the alphabetic command directory that end with a question mark. These commands are called query commands since each returns a response to a particular question. For example, access the LINE? query command from the command menu and press the **Enter** key. The multimeter responds to this query command by measuring and displaying the power line frequency. (Use the right arrow key to view the entire response.) As another example, access the TEMP? command from the command menu and press **Enter**. This command returns the multimeter's internal temperature in degrees Centigrade.

Standard Queries

The FULL command menu contains the following standard query commands:

AUXERR?	MCOUNT?
CAL?	MSIZE?
CALNUM?	OPT?
ERR?	SSPARM?
ERRSTR?	STB?
ID?	TEMP?
ISCALE?	
LINE?	

Additional Queries

In addition to the queries listed above, you can create others by appending a question mark to any command that can be used to program the multimeter. For example, the AZERO command (**Auto Zero**

configuration key) enables or disables the autozero function. You can determine the present autozero mode by appending a question mark to the AZERO command. To do this, press:



The multimeter responds by displaying the present autozero mode (power-on mode = ON). (Notice that this command is immediately executed; you do not have to press the **Enter** key.)

The QFORMAT command can be used to specify whether query responses will be numeric, alpha, or a combination of alpha and numeric. Refer to the QFORMAT command in Chapter 6 of the HP 3458A Multimeter Operating, Programming, and Configuration Manual for more information.

Display Control

The shifted **Clear** key, the **Back Space** key, and the **Display/Window** keys (left and right arrow keys) allow you to control the display.

Clearing the Display

Whenever you want to clear information (such as a query response) from the display, press:

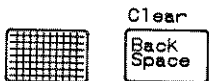

Display Editing

The **Back Space** key allows you to edit parts of a command string while entering the string or when the string is recalled (discussed later). For alpha parameters or command headers, pressing the **Back Space** key once erases the entire parameter or header. For commas, spaces, and numeric parameters, only one character is erased each time you press **Back Space**. For example, press:

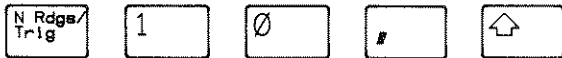

The display shows:

```
NRDGS 10,LINE■
```

By pressing the **Back Space** key once, the entire second parameter (LINE) is erased. The display shows:

```
NRDGS 10,■
```

Now by pressing **Back Space** once, the comma is erased. Pressing **Back Space** two more times erases both numeric characters (10). At this point, you can re-enter the first parameter using the numeric keypad and the second parameter using the **Menu Scroll** keys. Press the **Enter** key to execute the edited command.

Viewing Long Displays

When entering commands containing more than 16 characters, the previously entered characters are scrolled off the left side of the display to make room for those being entered. The **Display/Window** keys (left and right arrow keys) allow you to view the entire line by scrolling it left or right. The **Display/Window** keys can also be used to view long strings such as error messages and the calibration string (CALSTR? command). For example, press:

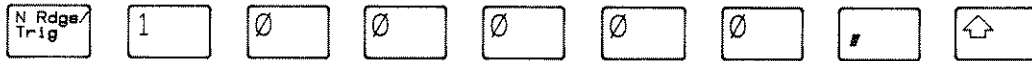

The display shows:

DGS 100000, LINE■

By pressing the left arrow key, you can view the first part of the command while scrolling the last part off the right side of the display. Now, by pressing the right arrow key, you can view the last part of the command and scroll the first part off the left side of the display.

MORE INFO Display

In addition to scrolling the display left and right, the **Display/Window** keys allow you to view additional display information when the display's **MORE INFO** annunciator is illuminated. For example, access and execute the SETACV RNDM command from the alphabetic command menu. Now press the front panel **ACV** key. Notice that the multimeter's **MORE INFO** annunciator is illuminated. This means there is more information available than is being displayed. Press:



The present AC voltage measurement method (SETACV RNDM) is displayed. At this point, reset the multimeter to return it to the power-on state by pressing:

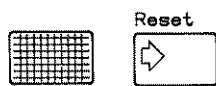

Digits Displayed

When the multimeter is displaying readings, you can vary the number of digits it displays. In the power-on state, the display is showing 7.5 digits although the multimeter is resolving 8.5 digits. To display all 8.5 digits, press:

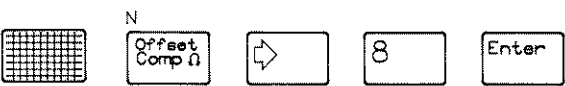

The display's leftmost digit (referred to as a 1/2 digit) is implied when you are specifying display digits.

The **NDIG** command only masks digits from the display. It does not affect readings sent to reading memory or transferred over the HP-IB bus. Also, you cannot view more digits than are being resolved by the multimeter.

Recall

You can easily recall the last executed command without repeating the command entry process. Press:



The display will show the last command executed. (You cannot recall commands that are executed immediately such as **Reset** or **DCV**, or any command that contained the calibration security code.) By repeating the above keystrokes, you can recall previously executed commands. After recalling the desired command, you can modify it (see "Display Editing" earlier in this section) and execute it by pressing **Enter**.

OPERATING FROM REMOTE

The following shows the fundamentals of operating the multimeter from remote. This includes reading and changing the HP-IB address, sending a command to the multimeter, and retrieving data from the multimeter.

Input/Output Statements

The statements used to operate the multimeter from remote depend on the computer and its language. In particular, you need to know the statements the computer uses to input and output information. For example, the input statements for the Hewlett-Packard Series 200/300 BASIC language are:

ENTER *or* TRANSFER

The output statement is:

OUTPUT

Read your computer manuals to find out which statements you need to use. The examples in this manual use Hewlett-Packard Series 200/300 BASIC language.

Reading the HP-IB Address

Before you can operate the multimeter from remote, you need to know its HP-IB address (factory setting = 22). To check the address, press:

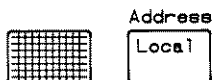

A typical display is:

ADDRESS 22 ■

The displayed response is the device address. When sending a remote command, you append this address to the HP-IB interface's select code (normally 7). For example, if the select code is 7 and the device address is 22, the combination is 722.

Changing the HP-IB Address

Every device on the HP-IB bus must have a unique address. If you need to change the multimeter's address, access the ADDRESS command from the command menu (MENU keys), with the display showing:

ADDRESS ■

You can enter the new address. For example, press:

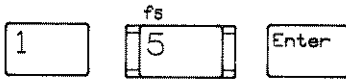

You have now changed the address to 15. If you want to change the address back to 22, repeat the above procedure (or use the **Recall** key) and specify 22 instead of 15.

Sending a Remote Command

To send the multimeter a remote command, combine the computer's output statement with the HP-IB select code, the device address, and finally, the multimeter command. For example, to make the multimeter beep, send:

```
OUTPUT 722;"BEEP"
```

Note the display's **REM** and **LSTN** annunciators are illuminated. This means the multimeter is in the remote mode and has been addressed to listen (received a command).

Getting Data from the Multimeter

The multimeter is capable of outputting readings and responses to query commands. As an example, have the multimeter generate a response to a query command by sending:

```
OUTPUT 722;"ID?"
```

When you send a query from remote, the multimeter does not display the response as it did when you executed the command from its front panel. Instead, the multimeter sends the response to its output buffer. The output buffer is a register that holds a query response or a single reading until it is read by the computer or replaced by new information. Use the computer's input statement to get the response from the output buffer. For example, the following program reads the response (HP3458A) and prints it.

```
10 ENTER 722;A$
20 PRINT A$
30 END
```

The same technique allows you to get readings from the multimeter. Whenever the multimeter is making measurements and you have not enabled reading memory (reading memory is discussed in Chapter 4), you can get a reading by running the following program.

```
10 ENTER 722;A
20 PRINT A
30 END
```

The Local Key

When you press a key on the multimeter's keyboard while operating from remote, the multimeter does not respond. This is because the multimeter is in the remote mode (as indicated by the display's **REM** annunciator) and is ignoring all but the **Local** key. To return the multimeter to local mode, press:

Local

Contents

Section 3 Disassembly/Assembly Procedures and Parts List

INTRODUCTION	1
STATIC HANDLING	1
CLEAN HANDLING	2
PRINTED CIRCUIT ASSEMBLY IDENTIFICATION	2
Board Part Number	2
Engineering Revision Code	2
COVERS REMOVAL/INSTALLATION PROCEDURES	3
Tools Required	3
Covers Removal Procedure	3
Covers Installation Procedure	6
ASSEMBLIES REMOVAL/INSTALLATION PROCEDURES	8
Tools Required	8
DC Circuitry Assembly Removal/Installation Procedures	8
Removal Procedure	11
Installation Procedure	11
DC Reference Assembly Removal/Installation Procedures	13
Removal Procedure	13
Installation Procedure	13
AC Converter Assembly Removal/Installation Procedures	14
Removal Procedure	14
Installation Procedure	15
A/D Converter Assembly Removal/Installation Procedures	15
Removal Procedure	15
Installation Procedure	16
Inguard Power Supply Assembly Removal/Installation Procedures	17
Removal Procedure	17
Installation Procedure	18
Outguard Controller Assembly Removal/Installation Procedures	19
Removal Procedure	19
Installation Procedure	20
Outguard Power Supply Assembly Removal/Installation Procedures	20
Removal Procedure	20
Installation Procedure	22
Display Logic Assembly Removal/Installation Procedures	23
Removal Procedure	23
Installation Procedure	27
Front/Rear Terminals Switch Removal/Installation Procedures	28
Removal Procedure	28
Installation Procedure	29

REPLACEABLE PARTS	30
Ordering Information	30
Direct Mail Ordering	30
Telephone Ordering	30
Replaceable Parts List	30

SECTION 3

DISASSEMBLY/ASSEMBLY PROCEDURES AND PARTS LIST

INTRODUCTION

This section contains the HP 3458A Covers and Printed Circuit Assemblies Disassembly/Assembly procedures. Also included is the HP 3458A Parts Lists and listings of printed circuit board assemblies.

WARNING

Only personnel with knowledge of electronic circuitry and an awareness with the hazards involved should remove and install any printed circuit board assemblies.

CAUTION

To prevent equipment circuit damage, always remove the ac line power cord before removing or replacing any assembly. To prevent static zap of ICs, always observe anti-static techniques when assemblies are handled or serviced.

STATIC HANDLING

Static electricity is a familiar phenomenon which, except for an occasional shock, doesn't seem very serious. However, it has been proven that in the electronics industry electrostatic discharge (ESD) is a major cause of component failure. In many cases, the component damaged may not immediately fail, causing low instrument reliability and future repairs. ESD damage can occur at static levels below human perception. It has also been shown that ESD can affect both passive and active devices.

The following guidelines are the minimum requirements for a static safe service environment.

- The workbench should be equipped with a conductive table mat. The mat should be grounded to earth ground through a 1 M ohm resistor. The mat should be equipped with at least one swivel connector for connecting wrist straps.
- All service and handling personnel should wear a conductive wrist strap in contact with bare skin. This strap should be connected to the swivel connector on the conductive table mat through a 1 M ohm resistor.
- All metal equipment at a work station must be grounded. This includes soldering irons, solder removers, shelving, and equipment stands.
- Only one common ground should be provided at the workstation.

- The workstation should be kept free of nonconductors. No common plastics, polybags, cardboard, cigarette or candy wrappers should be allowed. There should not be rugs or carpet on the floor, shelving, or bench top.
- Only proper containers should be used for shipping, storing or transporting assemblies. This is *required* on any assembly shipped to Hewlett-Packard for repair or replacement.

CLEAN HANDLING

Due to the accuracy of the HP 3458A, use the following clean handling techniques when removing/installing printed circuit board assemblies.

- Handle the assemblies only by their edges.
- Be sure to place them on a clean workbench away from dirty or dusty conditions.

PRINTED CIRCUIT ASSEMBLY IDENTIFICATION

The printed circuit assemblies within the HP 3458A Multimeter are identified by the HP part number of the printed circuit board and the engineering revision code (ERC). These two sequences of numbers are used to exactly identify the electrical characteristics of the printed circuit board. In any correspondence concerning a particular printed circuit board, it is important to accurately identify the board configuration. This is done by using the board part number, followed by the engineering revision code (ERC) on the board. For example:

03458-66505-2825

would identify a particular printed circuit board in the HP 3458A. The board part number is 03458-66505 and the ERC is 2825.

Board Part Number

The Hewlett-Packard part number of a printed circuit board is etched on the board. This is a ten digit number, separated by a hyphen into two groups of five digits. The first five digits identify the model number or accessory number of which the printed circuit board is a part. The last five digits are a unique part number identifying the printed circuit board.

Engineering Revision Code

On the Engineering Revision Code (ERC) label, the four digit code is in the form of YYWW, where YY represents the last two digits of the year minus 60 and WW is the week code. For example, an Engineering Revision Code of 2825 would identify a change made in the 25th week of 1988.

The ERC number is updated whenever a change is made to the assembly. This change may be a printed circuit board revision, a component change, or a revised test and assembly procedure. The ERC should be checked against schematics, component locator diagrams, and parts lists to ensure compatibility. ERCs with values lower than those noted on the schematics, component locator diagrams, and parts lists are described in a backdating section. ERCs with a value higher than those noted will be covered by a manual change sheet, manual update, or manual revisions.

NOTE
The label numbers in Figures 3-1 to 3-6 show the order of cover removal. Use reverse order for installation.

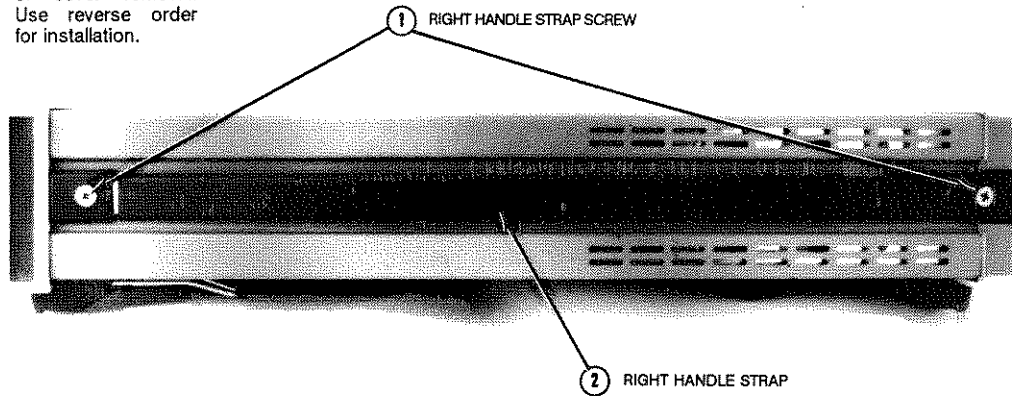

Figure 3-1. Right Side Handle Removal/Installation

COVERS REMOVAL/INSTALLATION PROCEDURES

The following procedures show how to remove the top/bottom covers and shields on the HP 3458A. Removal of the covers and shields are required to replace the printed circuit board assemblies.

Tools Required

You need:

1. #1 Pozidriv screwdriver
2. #TX15 Torx driver
3. #TX10 Torx driver

Covers Removal Procedure

Do the following:

1. Remove all connections to the HP 3458A.
2. Remove ac power from the HP 3458A.
3. Refer to Figure 3-1. Turn the instrument so its right side (as seen from the front) faces you.
4. Use the #1 pozidriv to remove the right side handle strap screws. Then remove the strap.
5. Refer to Figure 3-2. Turn the instrument so its left side faces you.

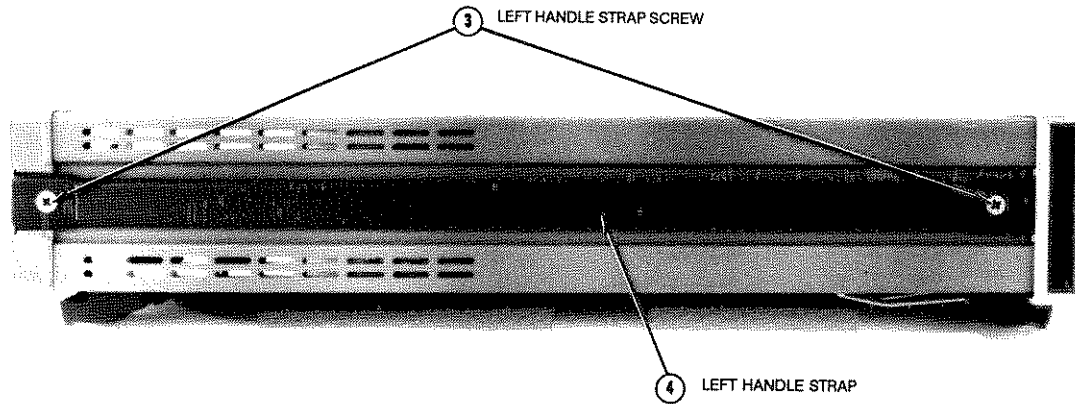

Figure 3-2. Remove/Install Left Side Handle

6. Use the #1 pozidriv to remove the left side handle strap screws. Then remove the strap.
7. Refer to Figure 3-3. Use the #TX10 Torx driver to remove both or either the top and bottom cover ground screws, depending on which cover is to be removed.
8. Refer to Figure 3-4. Turn the instrument so its back faces you.
9. Use the #TX15 Torx driver to remove the four rear bezel screws. Then remove the rear bezel.
10. If you do not wish to remove the top cover, continue with step 12.
11. To remove the top cover, pull the cover toward the rear until it clears the front panel. Then slide it forward and away from the instrument.
12. If you do not wish to remove the bottom cover, continue with step 14.
13. Turn the HP 3458A over so its top sits on your workbench. To remove the bottom cover, pull the cover toward the rear until it clears the front panel. Then slide it forward and away from the instrument. Leave the instrument in its present position.
14. If you do not wish to remove the bottom shield, continue with step 16.
15. Refer to Figure 3-5. Use the #TX10 Torx driver to remove the bottom shield screw. Then remove the shield. Pull the shield toward the rear of the instrument until the shield retainers line up with the slots in the shield. Lift the shield off.
16. If you do not wish to remove the top shield, continue with step 19.

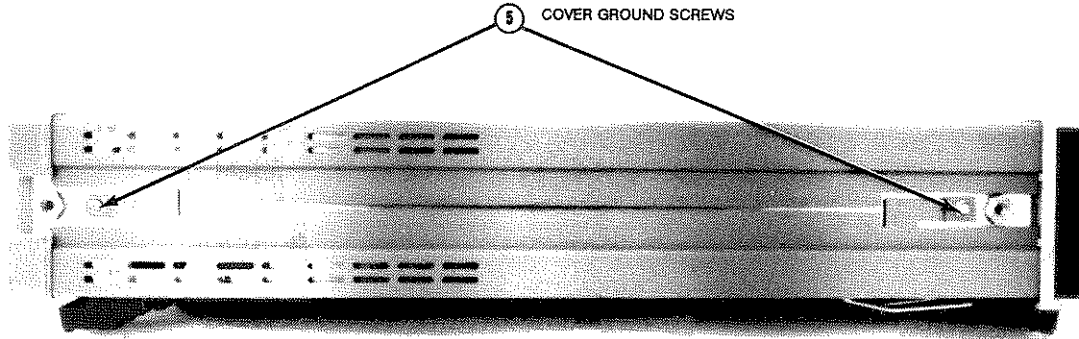

Figure 3-3. Remove/Install Cover Ground Screws

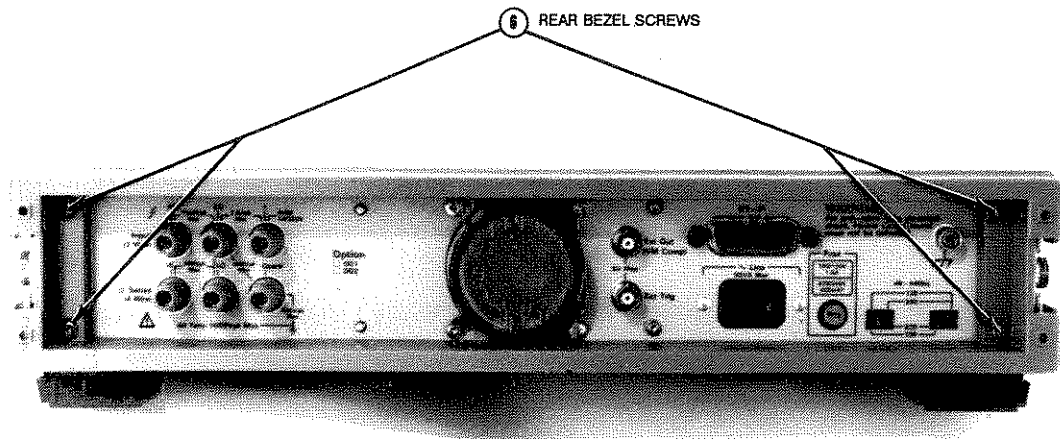

Figure 3-4. Remove/Install Rear Bezel

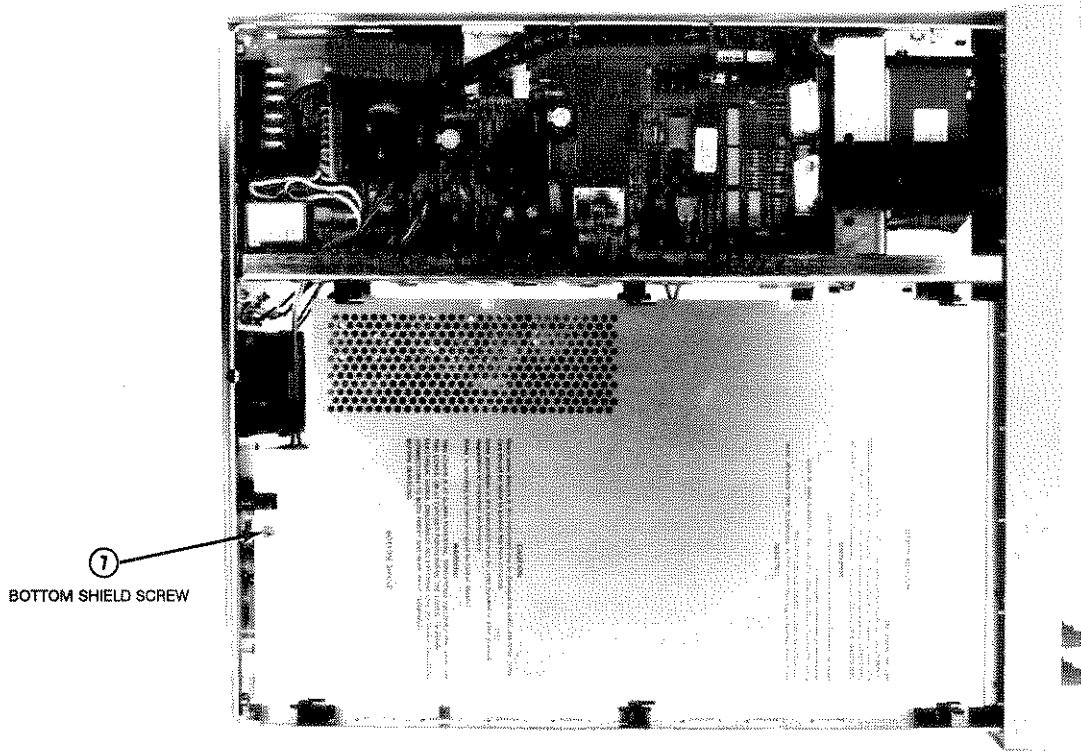

Figure 3-5. Remove/Install Bottom Shield Screw

17. Refer to Figure 3-6. Turn the instrument over so its bottom sits on your workbench.
18. Use the #TX10 Torx driver to remove the top shield screw. Then remove the shield. Pull the shield toward the rear of the instrument until the shield retainers line up with the slots in the shield. Lift the shield off.
19. Refer to the appropriate procedures in this section to remove the printed circuit board assembly.

Covers Installation Procedure

Do the following:

1. Remove all connections to the HP 3458A.
2. If installing the top shield is not required, continue with step 6.
3. Refer to Figure 3-6. Turn the instrument over so its bottom sits on your workbench.
4. Line up the slots on the top shield with the shield retainers. Then push the shield toward the front of the instrument until the shield screw hole lines up with the hole in the chassis. Use the #TX10 Torx driver to reinstall the shield screw.
5. If installing the bottom shield is not required, continue with step 9.
6. Refer to Figure 3-5. Turn the instrument over so its top sits on your workbench.

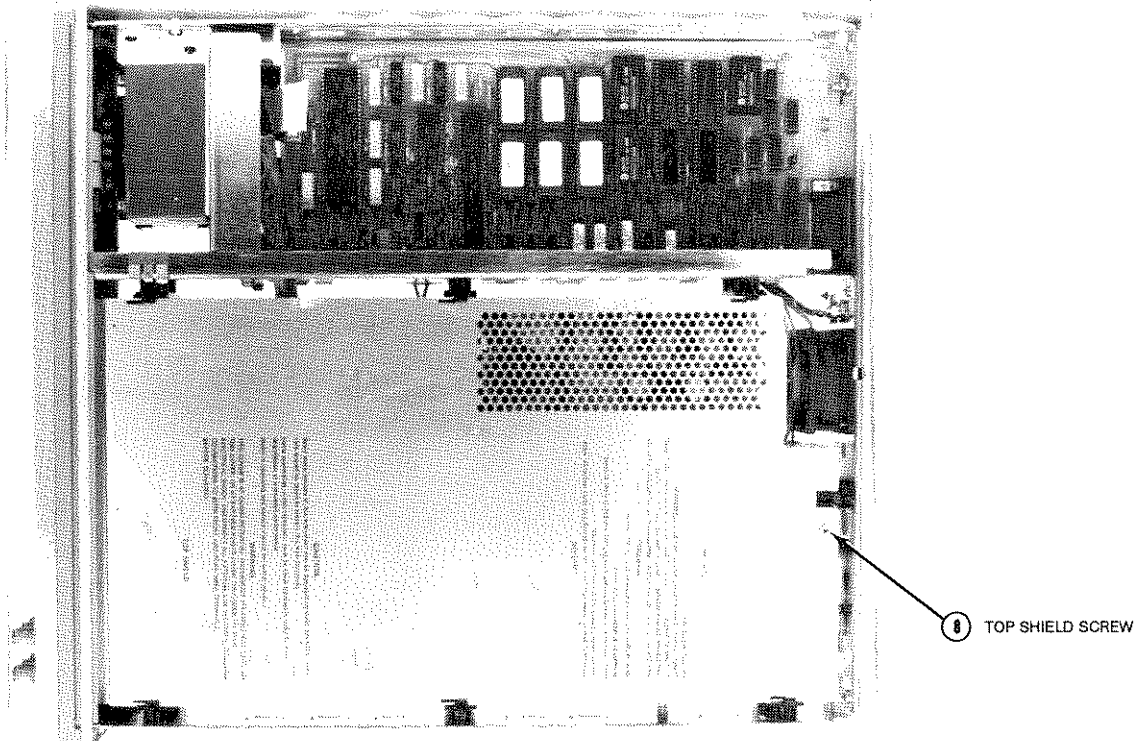

Figure 3-6. Remove/Install Top Shield Screw

7. Remove ac power from the HP 3458A.
8. Line up the slots on the bottom shield with the shield retainers. Then push the shield toward the front of the instrument until the shield screw hole lines up with the screw hole in the chassis. Use the #TX10 Torx driver to reinstall the shield screw.
9. If installing the bottom cover is not required, continue with step 11.
10. Install the bottom cover by placing it over the chassis with the front of the cover just clearing the front panel. Then push the cover toward the front of the instrument into the front panel bezel.
11. If installing the top cover is not required, continue with step 14.
12. Turn the HP 3458A over so the bottom sits on your workbench.
13. Install the top cover by placing it over the chassis with the front of the cover just clearing the front panel. Then push the cover toward the front of the instrument into the front panel bezel.
14. Refer to Figure 3-4. Turn the instrument so its back faces you.
15. Reinstall the rear bezel. Use the #TX15 Torx driver to reinstall the four rear bezel screws.
16. Refer to Figure 3-3. Turn the instrument so its left side faces you. Use the #TX10 Torx driver to reinstall the top and/or bottom cover ground screws.

WARNING

For safety purposes and proper operation, it is imperative that the cover grounding screws be reinstalled.

17. Refer to Figure 3-2. Reinstall the left side handle strap. Use the #1 pozidriv to reinstall the side handle strap screws.
18. Refer to Figure 3-1. Turn the instrument so its right side faces you.
19. Reinstall the right side handle strap. Use the #1 pozidriv to reinstall side handle strap screws.
20. Your instrument is now ready for use. HP suggests that after you apply power that you perform an automatic calibration on the instrument. To do this, use the "ACAL ALL" command.

ASSEMBLIES REMOVAL/INSTALLATION PROCEDURES

Table 3-1 lists all HP 3458A printed circuit board assemblies and assembly locations in the instrument. The assembly locations are also shown in in Figures 3-7 and 3-8.

Table 3-1. HP 3458A Assemblies Locations

Ref Desig	HP Part Number	Assembly Description	Location in Instrument
A1	03458-66501	DC Circuitry	Inguard/Top
A2	03458-66502	AC Converter	Inguard/Bottom
A3	03458-66503	A/D Converter and Inguard Logic	Inguard/Bottom
A4	03458-66504	Inguard Power Supply	Inguard/Bottom
A5	03458-66505	Outguard Controller	Outguard/Top
A5	03458-66515	Outguard Controller (Opt 001)	Outguard/Top
A6	03458-66506	Outguard Power Supply	Outguard/Bottom
A7	03458-66507	Display Logic	Front Panel
A9	03458-66509	DC Reference	Inguard/Top
A9	03458-66519	DC Reference (Opt 002)	Inguard/Top
A10	03458-66510	Front/Rear Switch	Inguard/Top

Tools Required

You need:

1. #1 Pozidriv screwdriver
2. #TX15 Torx driver
3. #TX10 Torx driver
4. 7 millimeter nut driver (for Outguard Controller assembly only)
5. Small flat bladed screwdriver (for Display Logic assembly only)
6. Large screwdriver (e.g., #2 Pozidriv; for Display Logic assembly only)

DC Circuitry Assembly Removal/Installation Procedures

The following procedures show how to remove and install the DC Circuitry Printed Circuit Board Assembly.

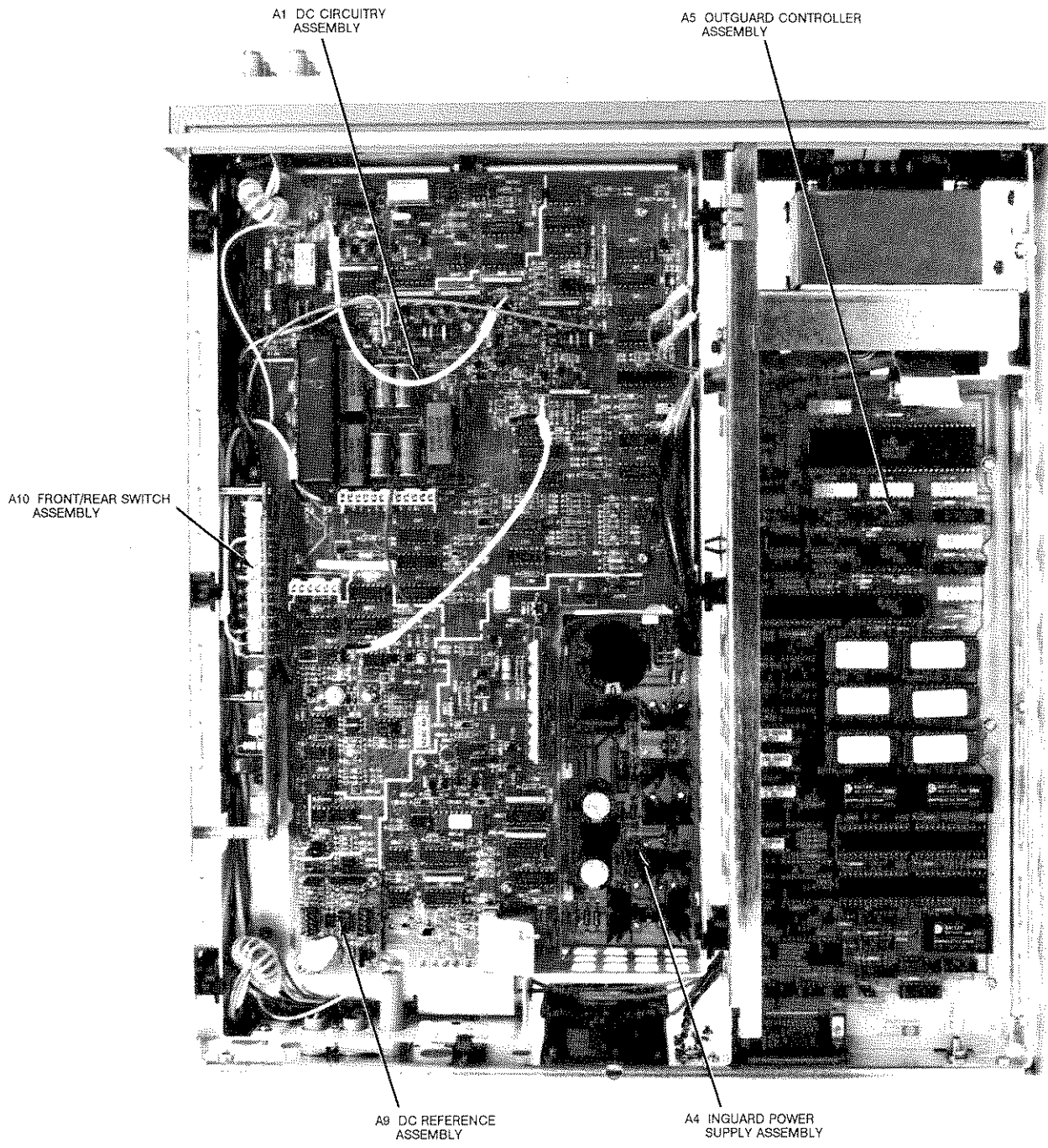

Figure 3-7. Assembly Locations (Top of Instrument)

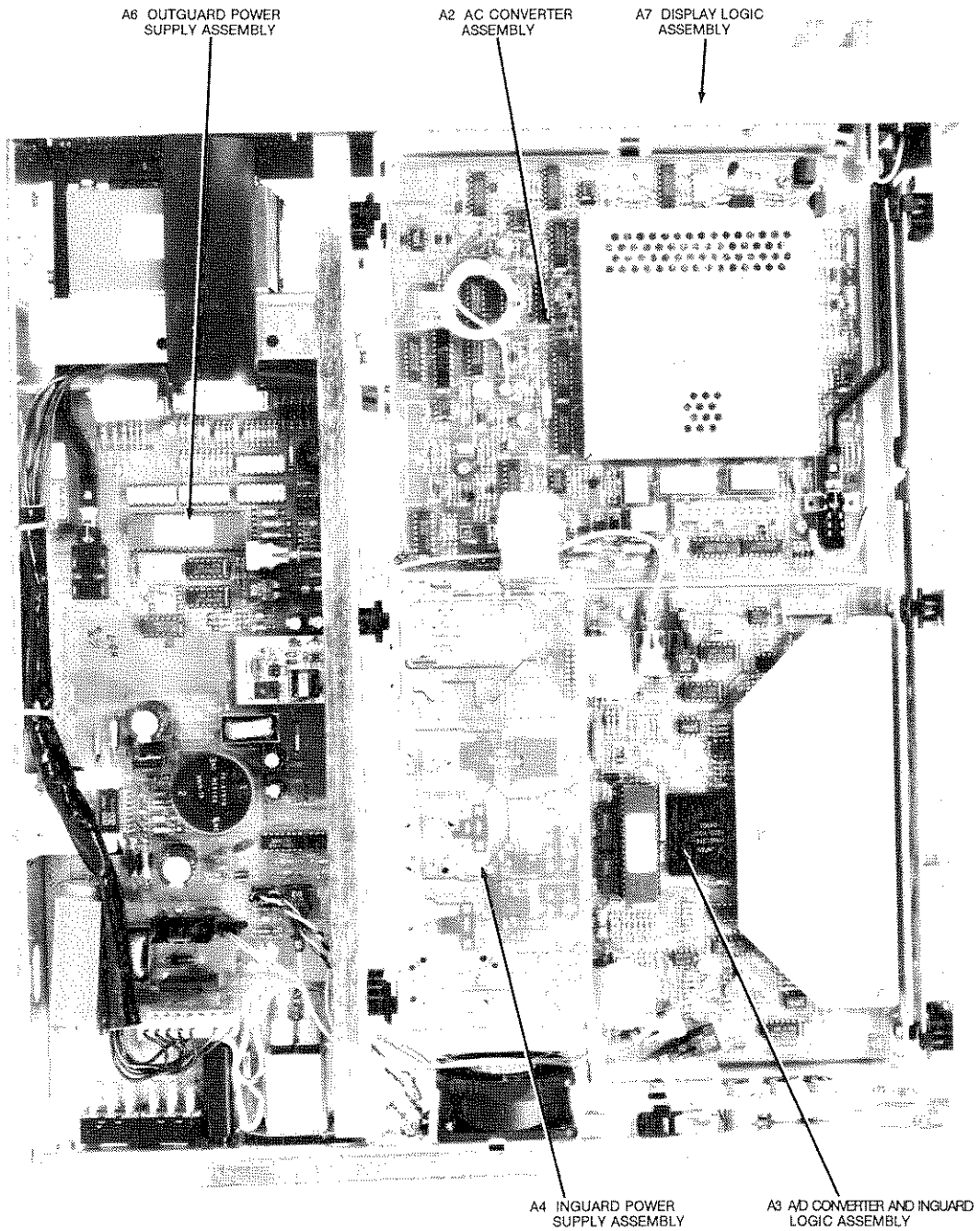

Figure 3-8. Assembly Locations (Bottom of Instrument)

Refer to Figure 3-9 for the following procedures.

Removal Procedure

1. Use the Covers Removal Procedure in this section of the manual to remove the HP 3458A top cover and top shield. It is not necessary to remove the bottom cover and bottom shield.
2. Set the HP 3458A on your work bench with the top facing you.
3. Unplug the following wires and cables. Unless otherwise noted, all wires and cables are unplugged from the DC Circuitry assembly.
 - a. Blue wire from the metal inguard shield. This wire is not plugged into the DC Circuitry assembly, but must be unplugged to remove the assembly. Move the wire out of the way.
 - b. Grey wire from the metal inguard circuit ground. This wire is not plugged into the DC Circuitry assembly, but must be unplugged to remove the assembly. Move the wire out of the way.
 - c. Yellow wire from P202. Move the wire out of the way.
 - d. Orange wire from P7. Move the wire out of the way.
 - e. Grey wire from P6. Move the wire out of the way.
 - f. Black and white wires from P8 and P9, respectively. The black and white wires form a white cable. Move the cable out of the way.
 - g. Grey 20 pin cable from P3. Move the cable out of the way.
4. Use the #TX10 Torx driver to remove the two screws from the DC Reference assembly.
5. Use the #TX10 Torx driver to remove the eight screws from the DC Circuitry assembly.
6. Use the plastic board extractor on the DC Circuitry board to unplug the board from the inguard chassis. Then completely remove the board.

Installation Procedure

1. Line up the DC Circuitry board with the connector in the inguard chassis. Plug the board into the connector.
2. Use the #TX10 Torx driver to install the eight screws on the DC Circuitry assembly.
3. Use the #TX10 Torx driver to install the two screws on the DC Reference assembly.
4. Plug in the following wires and cables:
 - a. Locate the blue wire connected to the power transformer. Plug the wire into the metal inguard shield.
 - b. Locate the grey wire connected to the power transformer. Plug the wire into the metal inguard circuit ground.

NOTE
 The label numbers show the order of assembly removal. Use reverse order for installation.

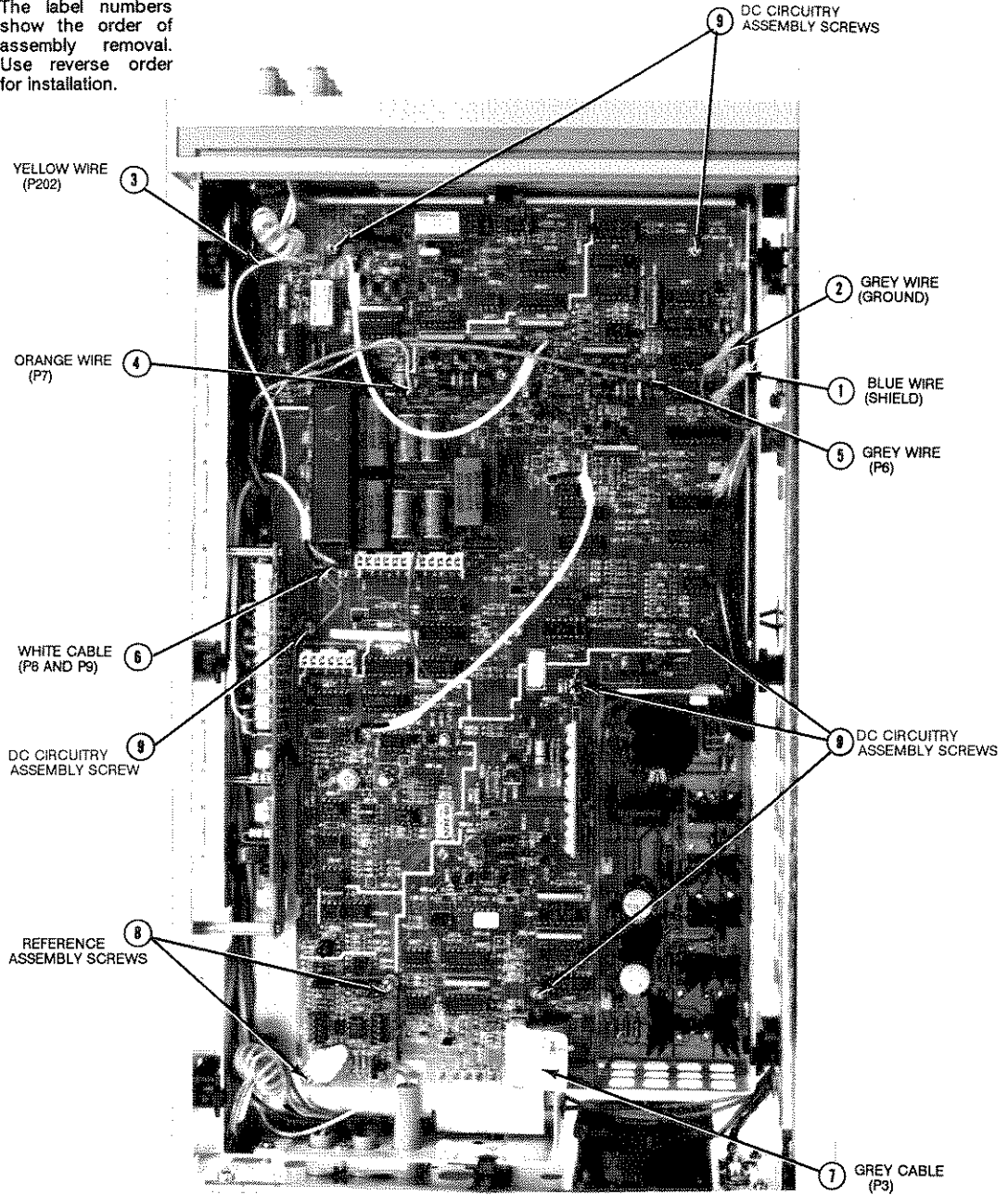

Figure 3-9. DC Circuitry Assembly Removal/Installation

- c. Locate the yellow wire connected to the Front/Rear Switch assembly. Plug it into P202 on the DC Circuitry assembly.
 - d. Locate the orange wire connected to the Front/Rear Switch assembly. Plug it into P7 on the DC Circuitry assembly.
 - e. Locate the grey wire connected to the Front/Rear Switch assembly. Plug it into P6 on the DC Circuitry assembly.
 - f. Locate the white cable with the white and black wires connected to the Front/Rear Switch assembly. Plug the white and black wires into P8 and P9, respectively. P8 and P9 are on the DC Circuitry assembly.
 - g. Locate the grey 20 pin cable connected to the A/D Converter and Inguard Logic assembly. Line up the cable plug with socket P3 on the DC Circuitry assembly. Then plug the cable all the way in.
5. Use the Covers Installation Procedure in this section of the manual to install the HP 3458A top cover and top shield.

DC Reference Assembly Removal/Installation Procedures

The following procedures show how to remove and install the DC Reference Printed Circuit Board Assembly.

Refer to Figure 3-9 for the following procedures.

Removal Procedure

1. Use the Covers Removal Procedure in this section of the manual to remove the HP 3458A top cover and top shield. It is not necessary to remove the bottom cover and bottom shield.
2. Set the HP 3458A on your work bench with the top facing you.
3. Use the #TX10 Torx driver to remove the two screws from the DC Reference assembly.
4. Unplug and remove the board from the DC Circuitry assembly.

Installation Procedure

1. A top and bottom cover needs to be installed over the reference device located on the DC Reference assembly. To install the covers, place one cover over the top of the device and another on the bottom side of the DC Reference assembly printed circuit board. Use your fingers to hold the covers in place. Then line up the screw holes in the covers with the screw holes on the printed circuit board. The covers should now completely enclose the reference device.
2. Line up the DC Reference board with the connectors on the DC Circuitry assembly. Hold the covers over the reference device in place while installing the DC Reference assembly. Then plug the board all the way into the connectors.
3. Use the #TX10 Torx driver to install the two screws on the DC Reference assembly.
4. Use the Covers Installation Procedure in this section of the manual to install the HP 3458A top cover and top shield.

NOTE
The label numbers show the order of assembly removal. Use reverse order for installation.

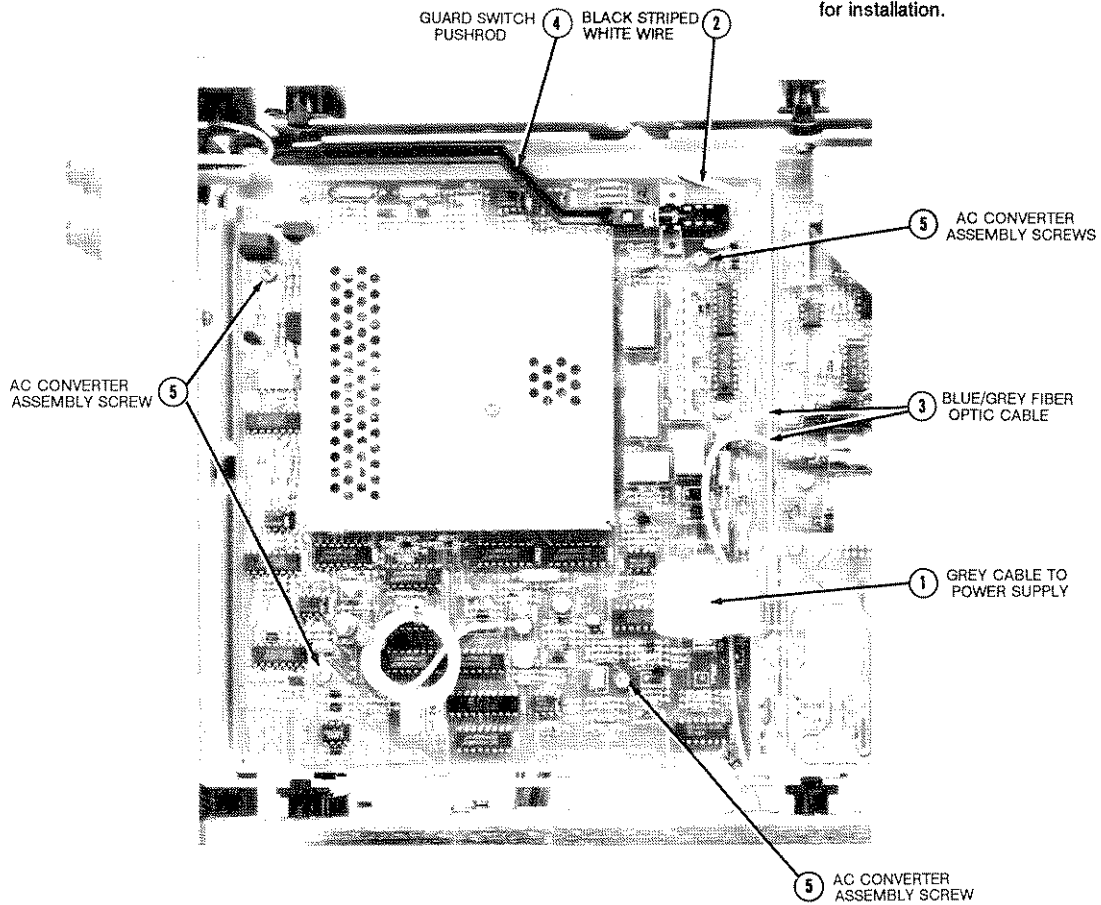

Figure 3-10. AC Converter Assembly Removal/Installation

AC Converter Assembly Removal/Installation Procedures

The following procedures show how to remove and install the AC Converter Printed Circuit Board Assembly.

Refer to Figure 3-10 for the following procedures.

Removal Procedure

1. Use the Covers Removal Procedure in this section of the manual to remove the HP 3458A bottom cover and bottom shield. It is not necessary to remove the top cover and top shield.
2. Set the HP 3458A on your work bench with the bottom facing you.
3. Unplug the grey 20 pin cable from the AC Converter assembly.
4. Unplug the black striped white wire from the metal inguard chassis.

5. For easier removal of the AC Converter assembly, you may wish to unplug and lay aside both the blue and grey fiber optic cables connecting the A/D Converter and Inguard Logic assembly to the outguard.
6. Remove the pushrod from the Guard switch. You may need to pry the pushrod loose with a small flat blade screwdriver. Then completely remove it from the rear of the front panel.
7. Use the #TX10 Torx driver to remove the four screws from the AC Converter assembly.
8. Unplug and remove the AC Converter board from the inguard chassis.

Installation Procedure

1. Line up the AC Converter board with the connector in the inguard chassis. Then plug the board all the way into the connector.
2. Use the #TX10 Torx driver to install the four screws on the AC Converter assembly.
3. Locate the grey 20 pin cable connected to the Inguard Power Supply assembly. Line up the cable plug with the socket on the AC Converter assembly. Then plug the cable all the way in.
4. Plug the black striped white wire from the AC Converter into the metal inguard chassis.
5. Plug in both the blue and grey fiber optic cables into the A/D Converter and Inguard Logic assembly, if previously unplugged.
6. Guide the Guard switch pushrod through the rear of the front panel's access hole. Then align the pushrod with the Guard switch shaft and push it all the way onto the shaft.
7. Use the Covers Installation Procedure in this section of the manual to install the HP 3458A bottom cover and bottom shield.

A/D Converter Assembly Removal/Installation Procedures

The following procedures show how to remove and install the A/D Converter and Inguard Logic Printed Circuit Board Assembly.

Refer to Figure 3-11 for the following procedures.

Removal Procedure

1. Use the Covers Removal Procedure in this section of the manual to remove the HP 3458A bottom cover and bottom shield. It is not necessary to remove the top cover and top shield.
2. Set the HP 3458A on your workbench with the bottom facing you.
3. Locate the grey 20 pin cable that connects the A/D Converter and Inguard Logic assembly to the Inguard Power Supply assembly. Unplug this cable at the A/D Converter and Inguard Logic assembly.
4. Locate the grey 20 pin cable that connects the A/D Converter and Inguard Logic assembly to the DC Circuitry assembly. Unplug this cable at the A/D Converter and Inguard Logic assembly.
5. Unplug both sets (four cables) of the blue and grey fiber optic cables that connect the A/D Converter and Inguard Logic assembly to the Outguard Power Supply assembly.

NOTE
The label numbers show the order of assembly removal. Use reverse order for installation.

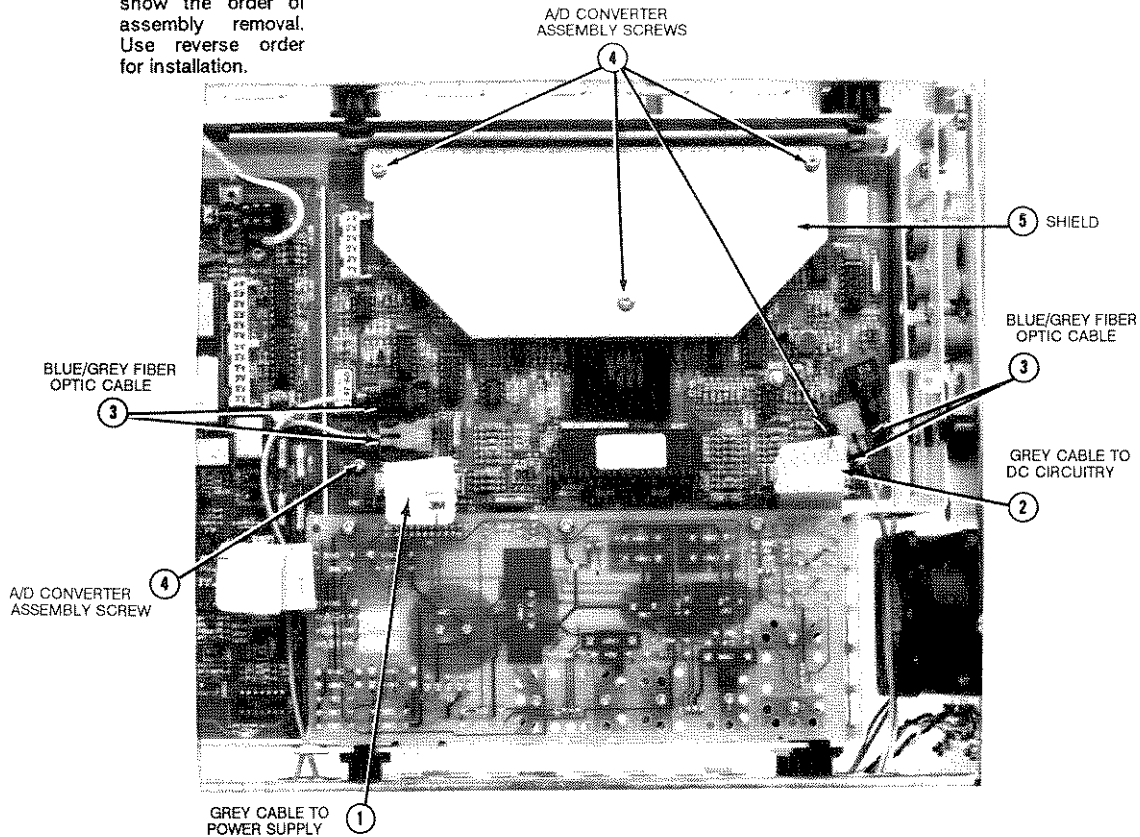

Figure 3-11. A/D Converter and Inguard Logic Assembly Removal/Installation

6. Use the #TX10 Torx driver to remove the three screws on the shield and the two screws on the A/D Converter and Inguard Logic assembly. Then remove the shield.
7. Unplug and remove the A/D Converter and Inguard Logic board from the inguard chassis.

Installation Procedure

1. Line up the A/D Converter and Inguard Logic board with the connector in the inguard chassis. Then plug the board all the way into the connector.
2. Place the A/D Converter and Inguard Logic shield on the board. Then use the #TX10 Torx driver to install the three screws on the shield.
3. Locate the grey 20 pin cable connected to the Inguard Power Supply assembly. Line up the cable plug with the corresponding socket on the A/D Converter and Inguard Logic assembly. Then plug the cable all the way in.

NOTE
The label numbers in Figures 3-12 and 3-13 show the order of assembly removal. Use reverse order for installation.

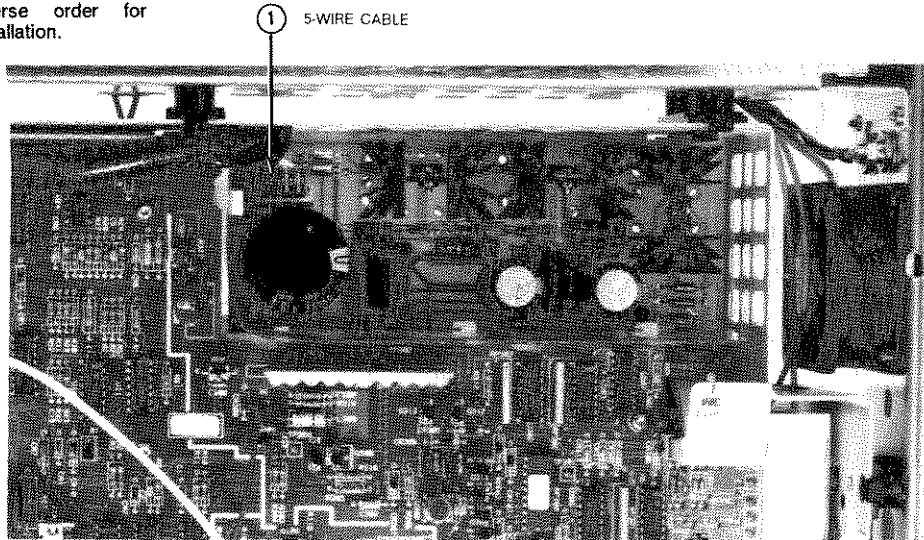

Figure 3-12. Remove/Install Transformer Cable on Inguard Power Supply

4. Locate the grey 20 pin cable connected to the DC Circuitry assembly. Line up the cable plug with the corresponding socket on the A/D Converter and Inguard Logic assembly. Then plug the cable all the way in.
5. Plug in both sets of the blue and grey fiber optic cables into the corresponding sockets on the A/D Converter and Inguard Logic assembly.
6. Use the Covers Installation Procedure in this section of the manual to install the HP 3458A bottom cover and bottom shield.

Inguard Power Supply Assembly Removal/Installation Procedures

The following procedures show how to remove and install the Inguard Power Supply Printed Circuit Board Assembly.

Removal Procedure

1. Use the Covers Removal Procedure in this section of the manual to remove the HP 3458A top/bottom covers and top/bottom shields.
2. Set the HP 3458A on your workbench with the top facing you.
3. Refer to Figure 3-12. Unplug the 5 wire cable from the Inguard Power Supply assembly. This cable is connected to the power transformer.
4. Refer to Figure 3-13 for the rest of this procedure.
5. Set the HP 3458A on your workbench with the bottom facing you.

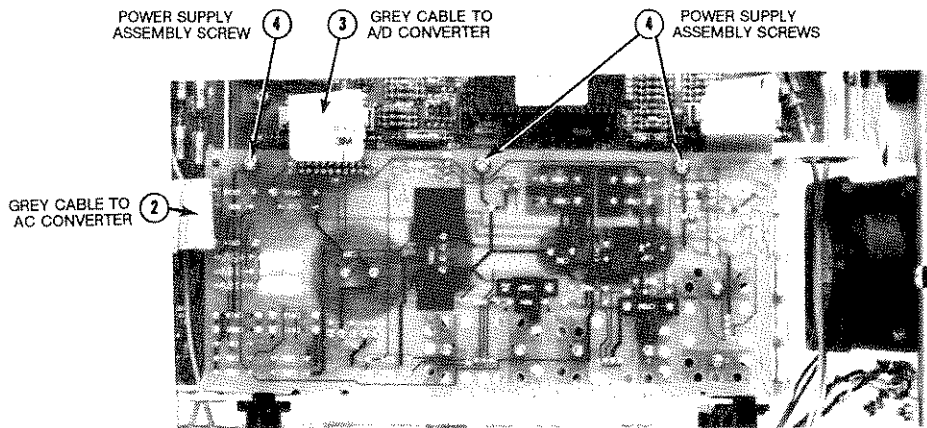

Figure 3-13. Inguard Power Supply Assembly Removal/Installation

6. Locate the grey 20 pin cable that connects between the A/C Converter assembly and Inguard Power Supply assembly. Unplug the cable at the power supply assembly.
7. Locate the grey 20 pin cable that connects between the A/D Converter assembly and Inguard Power Supply assembly. Unplug the cable at the power supply assembly, and Inguard Logic assembly.
8. Use the #TX10 Torx driver to remove the three screws on the Inguard Power Supply assembly.
9. Push the Inguard Power Supply assembly toward the left of the instrument (as seen from the front) until it clears the slot in the chassis. Then remove the board from the instrument.

Installation Procedure

1. Set the HP 3458A on your workbench with the bottom facing you.
2. Refer to Figure 3-13. Line up the Inguard Power Supply assembly with the slots in the chassis. Then push the board in.
3. Use the #TX10 Torx driver to install the three screws on the Inguard Power Supply board.
4. Locate the grey 20 pin cable connected to the AC Converter assembly. Line up the cable plug with the socket on the AC Converter assembly. Then plug the cable all the way in.
5. Locate the grey 20 pin cable connected to the A/D Converter and Inguard Logic assembly. Line up the cable plug with the socket on the A/D Converter and Inguard Logic assembly. Then plug the cable all the way in.

NOTE
The label numbers show the order of assembly removal. Use reverse order for installation.

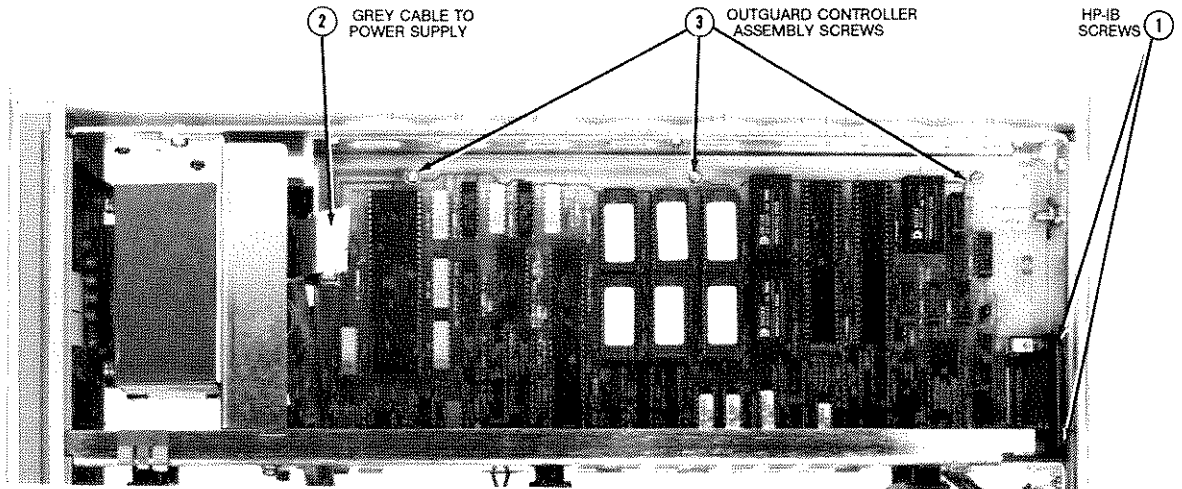

Figure 3-14. Outguard Controller Assembly Removal/Installation

6. Set the HP 3458A on your workbench with the top facing you.
7. Refer to Figure 3-12. Locate the cable connected to the power transformer. Line up the cable plug with the socket on the Inguard Power Supply assembly. Then plug the cable in.
8. Use the Covers Installation Procedure in this section of the manual to install the HP 3458A top/bottom covers and top/bottom shields.

Outguard Controller Assembly Removal/Installation Procedures

The following procedures show how to remove and install the Outguard Controller Printed Circuit Board Assembly.

Refer to Figure 3-14 for the following procedures.

Removal Procedure

1. Use the Covers Removal Procedure in this section of the manual to remove the HP 3458A top cover. It is not necessary to remove the bottom covers and the top/bottom shields.
2. Set the HP 3458A on your workbench with the top facing you.
3. Use a 7 millimeter nut driver to remove the two nuts on the rear panel HP-IB connector.

4. Locate the grey 20 pin cable that connects between the Outguard Controller assembly and Outguard Power Supply assembly. Unplug the cable at the controller assembly.
5. Use the #TX10 Torx driver to remove the three screws on the Outguard Controller assembly.
6. Push the board toward the front of the instrument, as far it will go, while the board is still laying down flat in the chassis.
7. Pull the outside edge of the board up. Do this until the inside edge of the board can be removed from the slots in the instrument chassis. Then pull the board completely out of the instrument.

Installation Procedure

1. Insert the Outguard Controller board into the slots in the chassis. Make sure the board is as far as possible toward the front of the instrument.
2. Place the rest of the board into the instrument until it lays down flat in the chassis. Then slide the board toward the rear of the instrument.
3. Use the #TX10 Torx driver to install the three screws on the Outguard Controller assembly.
4. Locate the grey 20 pin cable connected to the Outguard Power Supply assembly. Line up the cable plug with the socket on the Outguard Controller assembly. Then plug the cable in.
5. Use the 7 millimeter nut driver to install the two screws on the rear panel HP-IB connector.
6. Use the Covers Installation Procedure in this section of the manual to install the HP 3458A top cover.

Outguard Power Supply Assembly Removal/Installation Procedures

The following procedures show how to remove and install the Outguard Power Supply Printed Circuit Board Assembly.

Refer to Figure 3-15 for the following procedures.

Removal Procedure

1. Use the Covers Removal Procedure in this section of the manual to remove the HP 3458A bottom cover. It is not necessary to remove the top cover and the top/bottom shields.
2. Set the HP 3458A on your workbench with the top facing you.
3. Pull the power switch pushrod off the ac power switch. You may need to pry the pushrod loose with a small screwdriver. Then remove the pushrod by pulling it out of the front panel from the rear.
4. Locate the grey 20 pin cable that connects the Outguard Power Supply assembly to the Main Controller assembly. Unplug this cable at the Outguard Power Supply assembly.
5. Locate the grey 26 pin cable that connects the Outguard Power Supply assembly to the Display assembly. Unplug this cable at the Outguard Power Supply assembly.
6. Locate the 8 pin cable that connects the Outguard Power Supply assembly to the power transformer. Unplug the cable from the power supply assembly. Move the cable so it lays on the outside of the outguard chassis.

NOTE
 The label numbers show the order of assembly removal. Use reverse order for installation.

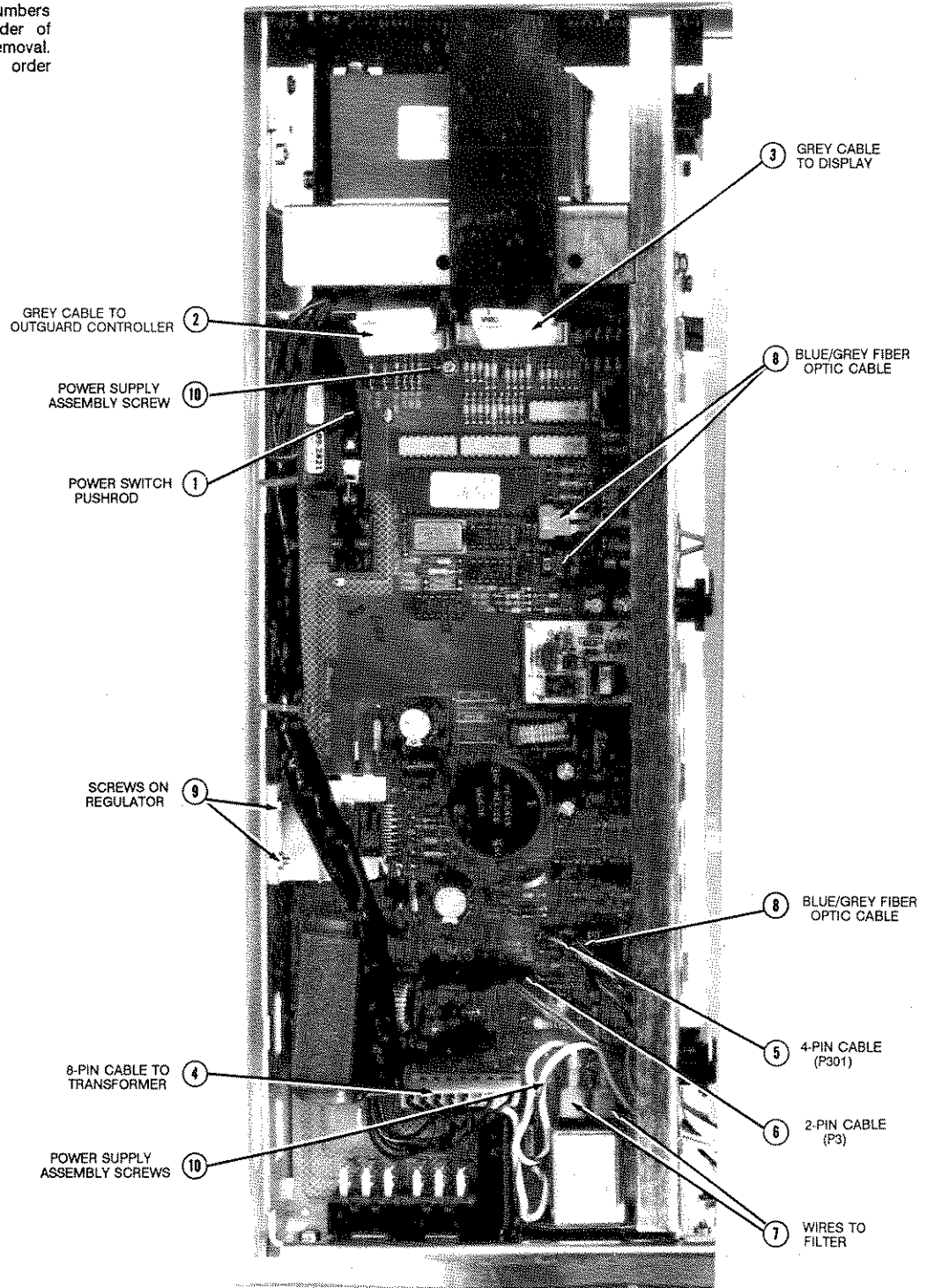

Figure 3-15. Outguard Power Supply Assembly Removal/Installation

7. Unplug the 4 pin cable from socket P301. This cable is connected to the Ext Out and Ext Trig connectors on the rear panel. Move the cable out of the way.
8. Unplug the 2 pin cable from socket P3. This cable is connected to the fan. Move the cable out of the way.
9. Unplug the two black striped white wires from the AC power filter on the rear panel. Move the wires out of the way.
10. Unplug both sets (four cables) of the blue and grey fiber optic cables from the Outguard Power Supply Assembly. These cables connect the A/D Converter and Inguard Logic assembly to the Outguard Power Supply assembly. Move the cables out of the way.
11. Use the #TX10 Torx driver to remove the two screws on the power supply regulator heat sink.
12. Use the #TX10 Torx driver to remove the two screws on the Outguard Power Supply assembly.
13. Push the Outguard Power Supply board toward the front of the instrument as far it will go. Then lift it up and away from the instrument.

Installation Procedure

1. Line up the slots on the Outguard Power Supply board with the sheet metal hook tabs on the chassis. Make sure the board is as far as possible toward the front of the instrument.
2. Place the board on top of the chassis. Then push it all the way to the rear of the instrument.
3. Use the #TX10 Torx driver to install the two screws on the power supply regulator heat sink.
4. Use the #TX10 Torx driver to install the two screws on the Outguard Power Supply assembly.
5. Plug in both sets of the blue and grey fiber optic cables into the corresponding sockets on the Outguard Power Supply assembly.
6. Locate the two black striped white wires. Connect the wire from "LINE" to the left terminal (as seen from the instrument's front) of the filter. Connect the "NEUTRAL" to the right terminal on the filter. These connections are also shown on a drawing on the Outguard Power Supply assembly. The drawing is located toward the rear of the board near ac line select switches.
7. Locate the 2 pin cable connected to the fan. Plug the cable into socket P3.
8. Locate the 4 pin cable connected to the Ext Out and Ext Trig connectors on the rear panel. Plug the cable into socket P301.
9. Locate the 8 pin cable connected to the power transformer. Move the cable so it lays on top of the Outguard Power Supply assembly. Then plug the cable into socket P3.
10. Locate the grey 20 pin cable connected to the Outguard Controller assembly. Line up the cable plug with the socket on the Outguard Power Supply assembly. Then plug it all the way in.
11. Guide the power switch pushrod through the rear of the transformer shield's access hole. Then guide the pushrod through the rear of the front panel's access hole. Align the pushrod with the ac power switch shaft and push it onto the shaft.

NOTE
The label numbers in Figures 3-16 and 3-20 show the order of assembly removal. Use reverse order for installation.

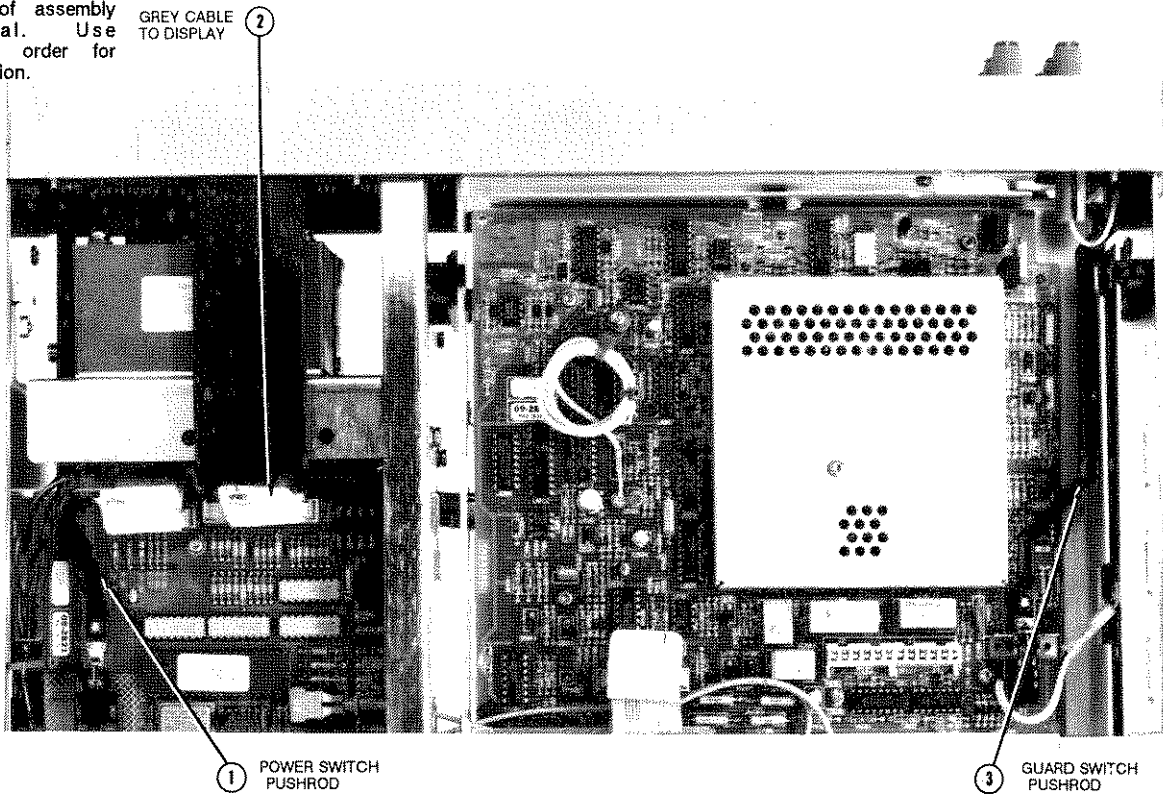

Figure 3-16. Guard and Power Pushrods, and Display Cable Locations

12. Use the Covers Installation Procedure in this section of the manual to install the HP 3458A bottom cover.

Display Logic Assembly Removal/Installation Procedures

The following procedures show how to remove and install the Display Logic Board Assembly.

Removal Procedure

1. Use the Covers Removal Procedure in this section of the manual to remove the HP 3458A top/bottom covers and top/bottom shields.
2. Set the HP 3458A on your workbench with the bottom facing you.
3. Refer to Figure 3-16. Do the following:
 - a. Locate and pull the power switch pushrod off the power switch. You may need to pry the pushrod loose with a small screwdriver. Then remove the pushrod by pulling it out of the front panel from the rear.

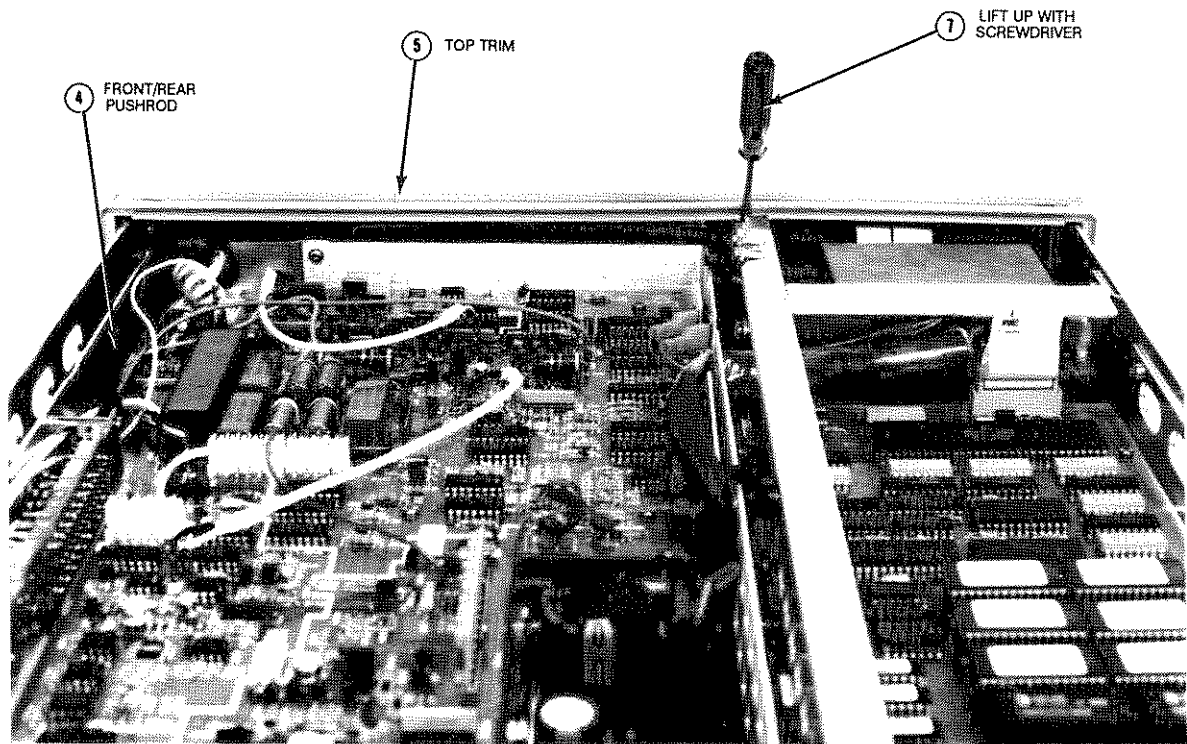

Figure 3-17. Top Trim and Front/rear Pushrod Locations, and Unlock Panel

- b. Locate the grey 26 pin cable that connects the Outguard Power Supply assembly to the Display assembly. Unplug this cable at the Outguard Power Supply assembly.
 - c. Locate and pull the Guard switch pushrod off the Guard switch. You may need to pry the pushrod loose with a small screwdriver. Then remove the pushrod by pulling it out of the front panel from the rear.
4. Set the HP 3458A on your workbench with the top facing you.
 5. Refer to Figure 3-17. Do the following:
 - a. Locate and pull the Front/Rear switch pushrod off the Front/Rear Terminals switch. You may need to pry the pushrod loose with a small screwdriver. Then remove the pushrod by pulling it out of the front panel from the rear.
 - b. With a small flat bladed screwdriver, pry the top trim loose and remove from the Front Panel assembly.
 6. Set the HP 3458A on your workbench with the left side facing you.
 7. Refer to Figure 3-18. Insert a large screwdriver between the Front Panel assembly and the chassis, as shown in the figure. With the screwdriver, carefully pry the left side of the Front Panel assembly loose. Move the front panel out of the chassis until it unlocks from the chassis. Do not move it any more, or it may break.

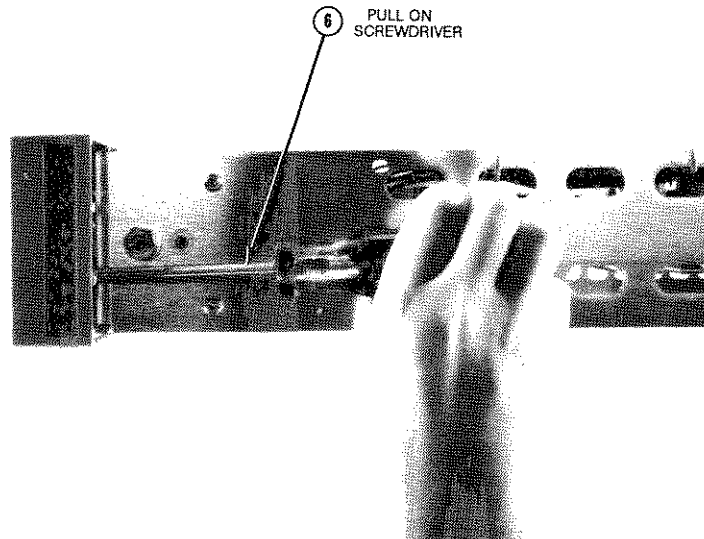

Figure 3-18. Remove Front Panel Assembly

8. Refer to Figure 3-17. With a small flat bladed screwdriver, lift up the Front Panel assembly and unlock it from the chassis. Carefully move some more of the Front Panel assembly's left side (as seen from the front of the instrument) until free from the chassis. Then move the rest of the Front Panel assembly out and away from the instrument as far as it can go. Note that the assembly can only be moved a short distance, since the front terminals are still internally connected to the instrument.
9. Turn the instrument so its front panel faces you.
10. Locate and unscrew (rotate counterclockwise) the current terminal binding post until it stops. Push in on the terminal and rotate it clockwise. Then remove the current terminal/fuse assembly.
11. Refer to Figure 3-19. Use the #TX10 Torx driver to remove the two Torx screws from the front terminals. Then use a #1 Pozidriv screwdriver to remove the two pozi screws from the front terminals. This removes the front terminals from the Front Panel assembly.
12. Completely remove the Front Panel assembly from the instrument.
13. Place the Front Panel assembly face down on a soft anti-static mat.
14. Refer to Figure 3-20. Use the #TX10 Torx driver to remove the single Torx screw from the Display assembly.
15. Push the Display board toward the left (with input terminals at your right side) as far as it can go. Then pull its bottom up and lift it out from the Front Panel assembly.

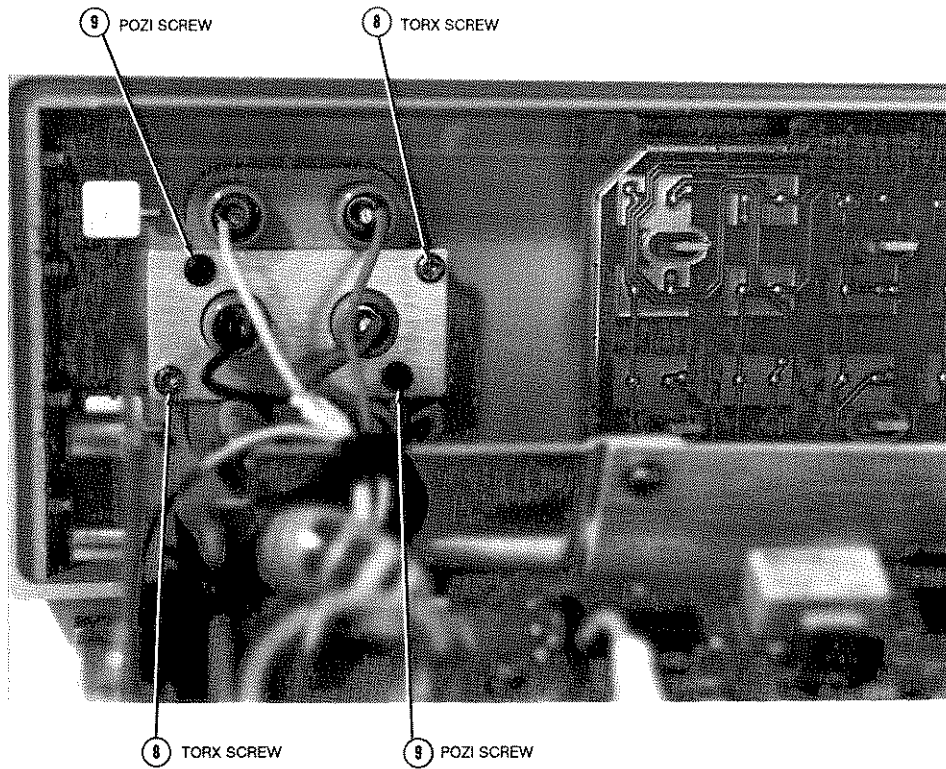

Figure 3-19. Remove/Install Screws on Front Terminals

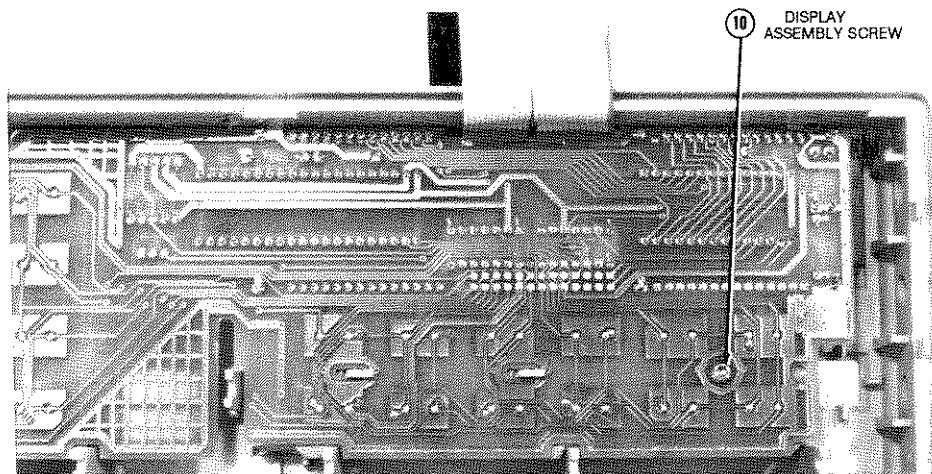

Figure 3-20. Remove/Install Display Screw

Installation Procedure

1. Align the slots in the Display assembly with the hook tabs on the Front Panel assembly. Be sure the board is as close to the left side of the Front Panel assembly as possible. Then push the board down until it locks in place.
2. Push the board as far as possible toward the right side of the Front Panel assembly.
3. Refer to Figure 3-20. Use the #TX10 Torx driver to install the screw on the Display assembly.
4. Set the HP 3458A on your workbench with the right side facing you.
5. Carefully place the front terminals into the appropriate holes in the front panel.
6. Refer to Figure 3-19. Use the #TX10 Torx driver to install the two Torx screws on the front terminals. Then use a #1 Pozidriv screwdriver to install the two pozi screws on the front terminals.
7. Set the HP 3458A on your workbench with the front facing you.
8. Place the Front Panel assembly in front of the chassis. Place the cable from the display below the power transformer.
9. Align the Front Panel assembly with the instrument chassis. Be sure the extension on the center portion of the instrument chassis is aligned with the slot in the display board.
10. Place the right side of the Front Panel assembly over the standoffs on the chassis. Then push the left side of the Front Panel assembly over the chassis standoffs until it locks in place.
11. Install the top trim into the channel on top of the Front Panel assembly. Lock it in place (see Figure 3-17).
12. Install the current terminal/fuse assembly into the binding post. Push the assembly in and turn counterclockwise until it locks in place.
13. Refer to Figure 3-17. Guide the Front/Rear Terminals switch pushrod through the rear of the front panel's access hole. Then align the pushrod with the Front/Rear Terminals switch shaft and push it all the way onto the shaft.
14. Set the HP 3458A on your workbench with the bottom facing you.
15. Refer to Figure 3-16. Do the following:
 - a. Guide the Guard switch pushrod through the rear of the front panel's access hole. Then align the pushrod with the Guard switch shaft and push it all the way onto the shaft.
16. Guide the power switch pushrod through the rear of the transformer shield's access hole. Then guide the pushrod through the rear of the front panel's access hole. Align the pushrod with the ac power switch shaft and push it into the onto the shaft.
 - b. Locate the grey 26 pin cable connected to the Display Logic assembly. Line up the cable plug with the socket on the Outguard Power Supply assembly connector. Then plug the cable all the way in.

NOTE
The label numbers show the order of assembly removal. Use reverse order for installation.

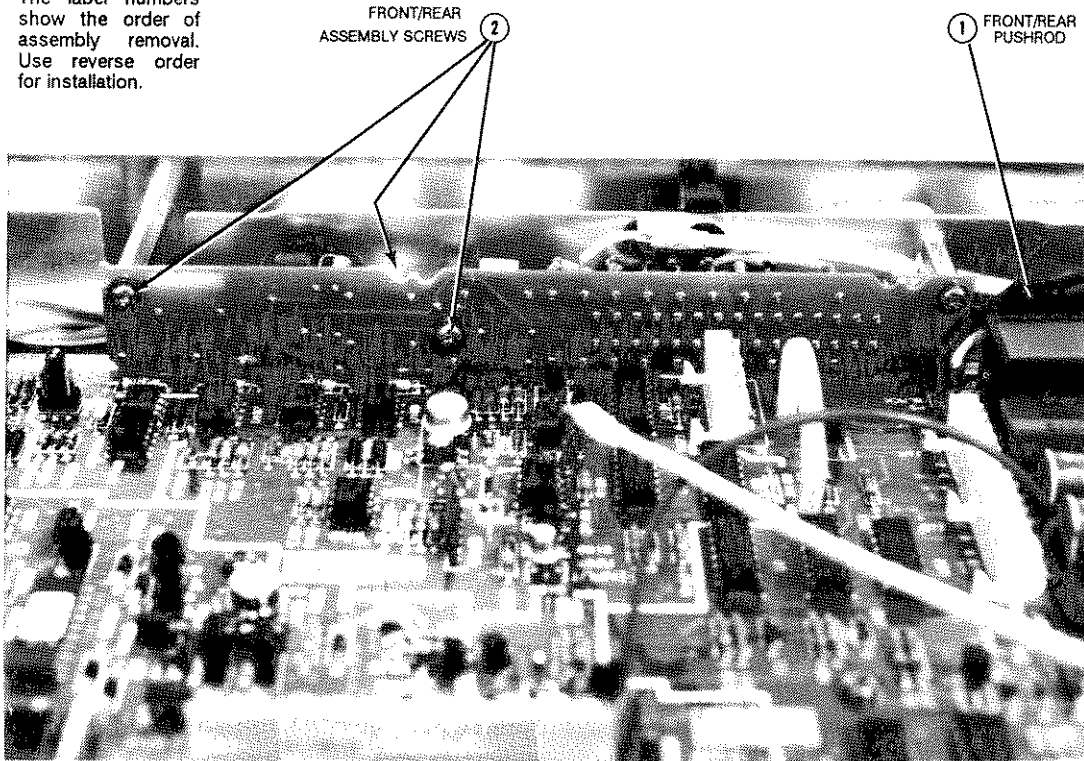

Figure 3-21. Front/Rear Terminals Switch Assembly Removal/Installation

17. Use the Covers Installation Procedure in this section of the manual to install the HP 3458A top/bottom covers and top/bottom shields.

Front/Rear Terminals Switch Removal/Installation Procedures

The following procedures show how to remove and install the Front/Rear Terminals Switch Assembly.

Refer to Figure 3-21 for the following procedures.

Removal Procedure

1. Use the Covers Removal Procedure in this section of the manual to remove the HP 3458A top cover and top shield. It is not necessary to remove the bottom cover and bottom shield.
2. Set the HP 3458A on your work bench with the top facing you.
3. Pull the Front/Rear Terminals switch pushrod off the Front/Rear Terminals switch. You may need to pry the pushrod loose with a small screwdriver. Then remove the pushrod by pulling it out of the front panel from the rear.

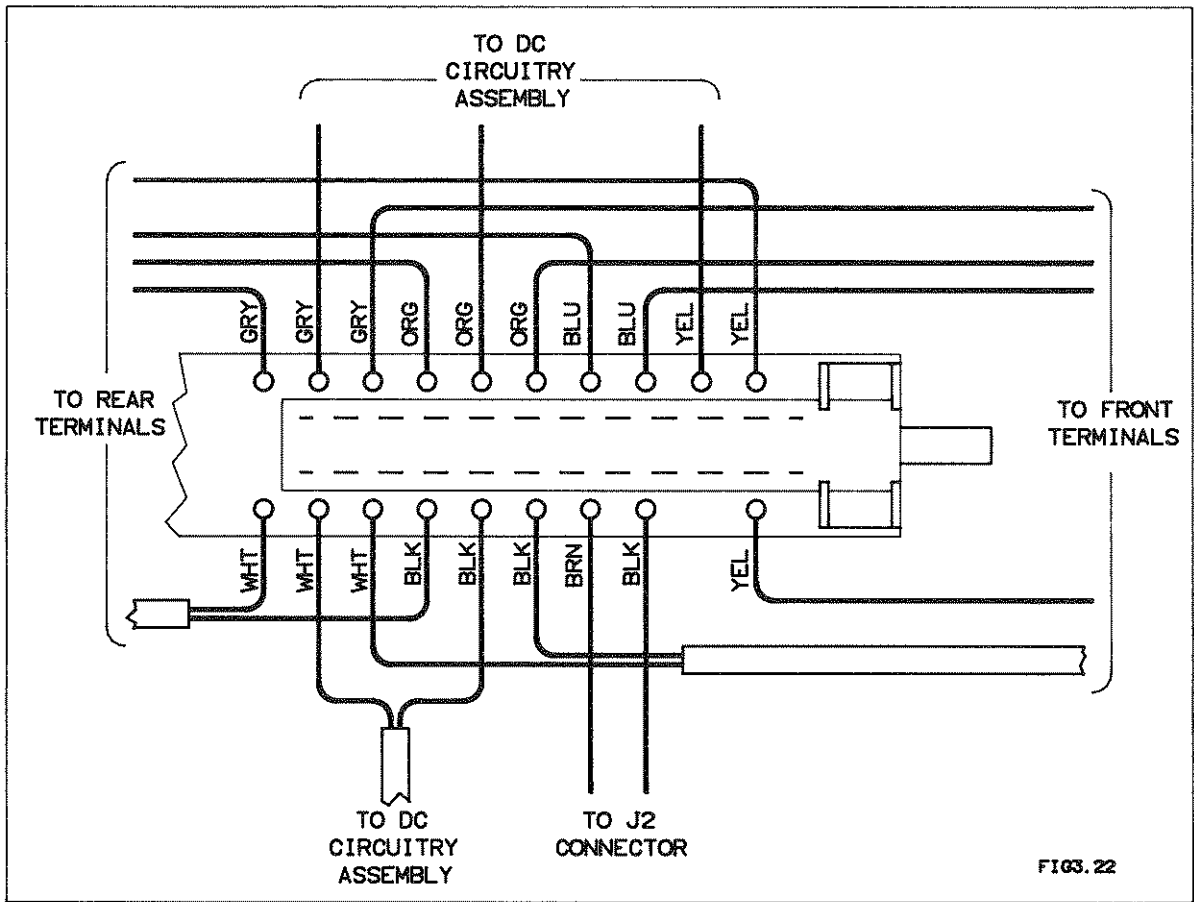

Figure 3-22. Wire/Cable Locations on Front/Rear Terminals Switch

4. Use the #TX10 Torx driver to remove the four screws from the Front/Rear Terminals switch assembly.
5. On the Front/Rear Terminals switch assembly, note for future reference the location of the wires connected to the assembly. These locations are also shown in Figure 3-22. Then unplug and lay aside all wires from the assembly.

Installation Procedure

1. Refer to Figure 3-22. Plug in all wires to the Front/Rear Terminals switch assembly. Use the wire locations noted in the previous procedure.
2. Line up the mounting holes of the assembly with the standoffs on the inguard chassis. Use the #TX10 Torx driver to install the four screws on the assembly.
3. Guide the Front/Rear Terminals switch pushrod through the rear of the front panel's access hole. Then align the pushrod with the Front/Rear Terminals switch shaft and push it all the way onto the shaft.
4. Use the Covers Installation Procedure in this section of the manual to install the HP 3458A top cover and top shield.

REPLACEABLE PARTS

Ordering Information

To order a part in the replaceable parts table, quote the Hewlett-Packard part number, the check digit (abbreviated CD), and the quantity desired. Address the order to the nearest Hewlett-Packard Sales Office. The offices are listed in back of this manual.

Direct Mail Ordering

Within the U.S.A., Hewlett-Packard can supply parts to your location through a direct mail order system. Mail order forms and specific ordering information are available through your local Hewlett-Packard Sales Office.

Telephone Ordering

Within the U.S.A., Hewlett-Packard can supply parts to your location by calling the following telephone number: 1-800-227-8164. The calling times are from 6 am to 5 pm, Pacific time, Monday through Friday. After hours and holidays, call (415) 968-2347. Be sure you have the correct part number available before calling. Visa and Mastercard are accepted.

A hotline service is available by calling the above telephone numbers. The service is available 24 hours a day, 365 days/year. This allows you to receive a replacement part the next business day. To cover the cost of freight and special handling, there will be a hotline charge of \$100.00 per order (three items maximum).

Replaceable Parts List

The HP 3458A replaceable parts are listed in Table 3-2. Also listed are the HP 3458A printed circuit board assemblies.

Table 3-2. HP 3458A Replaceable Parts

Ref Desig	HP Part Number	C D	Qty	Description	Mfr Code	Mfr Part Number
A1	03458-66501	8	1	PC ASSY-DC CIRCUITRY	28480	03458-66501
	0515-0372	2	8	SCREW-MACHINE ASSEMBLY M3 X 0.5 8MM-LG	93907	ORDER BY DESCRIPTION
	03458-43701	2	1	PUSHROD-186.2 LG	28480	03458-43701
	5041-0267	4	1	KEYCAP	28480	5041-0267
A2	03458-66502	9	1	PC ASSY-AC CONVERTER	28480	03458-66502
	0515-0372	2	4	SCREW-MACHINE ASSEMBLY M3 X 0.5 8MM-LG	93907	ORDER BY DESCRIPTION
	03458-00603	3	1	SHIELD-AC CONVERTER	28480	03458-00603
	0515-1410	1	1	SCREW-MACHINE ASSEMBLY M3 X 0.5 20MM-LG	83486	ORDER BY DESCRIPTION
	03458-43702	3	1	PUSHROD-177.6 LG	28480	03458-43702
	5041-0267	4	1	KEYCAP	28480	5041-0267
A3	03458-66503	0	1	PC ASSY-A/D CONVERTER AND INGUARD LOGIC	28480	03458-66503
	0515-0372	2	5	SCREW-MACHINE ASSEMBLY M3 X 0.5 8MM-LG	93907	ORDER BY DESCRIPTION
	03458-00607	7	1	SHIELD-A/D CONVERTER	28480	03458-00607
	0515-1410	1	3	SCREW-MACHINE ASSEMBLY M3 X 0.5 20MM-LG	83486	ORDER BY DESCRIPTION
A4	03458-66504	1	1	PC ASSY-INGUARD POWER SUPPLY	28480	03458-66504
	0515-0372	2	3	SCREW-MACHINE ASSEMBLY M3 X 0.5 8MM-LG	93907	ORDER BY DESCRIPTION
A5	03458-66505	2	1	PC ASSY-OUTGUARD CONTROLLER	28480	03458-66505
A5	03458-66515	4	1	PC ASSY-OUTGUARD CONTROLLER (OPT 001)	28480	03458-66515
	0515-0372	2	3	SCREW-MACHINE ASSEMBLY M3 X 0.5 8MM-LG	93907	ORDER BY DESCRIPTION
A6	03458-66506	3	1	PC ASSY-OUTGUARD POWER SUPPLY	28480	03458-66506
	0515-0372	2	4	SCREW-MACHINE ASSEMBLY M3 X 0.5 8MM-LG	93907	ORDER BY DESCRIPTION
	03458-43701	2	1	PUSHROD-186.2 LG	28480	03458-43701
	5041-0564	4	1	KEYCAP	28480	5041-0564
A7	03458-66507	4	1	PC ASSY-DISPLAY LOGIC	28480	03458-66507
	0624-0681	7	1	SCREW-TPG 4-20 .25-IN-LG PAN-HD-TORX T10	93907	225-05813-890BE112TXPNPLOZ
A9	03458-66509	6	1	PC ASSY-DC REFERENCE	28480	03458-66509
A9	03458-66519	8	1	PC ASSY-DC REFERENCE (OPT 002)	28480	03458-66519
	0515-1410	1	2	SCREW-MACHINE ASSEMBLY M3 X 0.5 20MM-LG	83486	ORDER BY DESCRIPTION
A10	03458-66510	9	1	PC ASSY-FRONT/REAR SWITCH	28480	03458-66510
	0515-0372	2	4	SCREW-MACHINE ASSEMBLY M3 X 0.5 8MM-LG	93907	ORDER BY DESCRIPTION
T1	9100-4715	5	1	TRANSFORMER-POWER	05216	ORDER BY DESCRIPTION
	0515-1404	3	4	SCREW-MACH M4 X 0.7 55MM-LG PAN-HD	93907	ORDER BY DESCRIPTION
MP1	03458-60201	3	1	ASSEMBLY-FRONT PANEL	28480	03458-60201
	03458-40202	2	1	PANEL-FRONT	28480	03458-40202
	03458-69302	3	1	WINDOW	28480	03458-69302
	03458-81902	5	1	KEYPAD	28480	03458-81902
MP2	5041-8802	9	1	TRIM TOP	28480	5041-8802

Table 3-2. HP 3458A Replaceable Parts (Cont)

Ref Desig	HP Part Number	C D	Qty	Description	Mfr Code	Mfr Part Number
MP3	03458-04101	4	1	COVER-TOP	28480	03458-04101
MP4	0515-0372	2	1	SCREW-MACHINE ASSEMBLY M3 X 0.5 8MM-LG	93907	ORDER BY DESCRIPTION
MP5	5001-0538	8	2	TRIM STRIP	28480	5001-0538
MP6	5062-3704	4	2	STRAP-HANDLE	28480	5062-3704
MP7	5041-8819	8	2	STRAP HOLDER-FRONT	28480	5041-8819
MP8	5041-8820	1	2	STRAP HOLDER-REAR	28480	5041-8820
MP9	0515-1132	4	4	SCREW-MACH M5 X 0.8 10MM-LG	N/A	ORDER BY DESCRIPTION
MP10	03458-00601	1	1	SHIELD-TOP	28480	03458-00601
MP11	0515-1604	5	2	SCREW-MACH M3.5 X 0.6 6MM-LG	93907	ORDER BY DESCRIPTION
MP12	03458-00106	1	1	CHASSIS-MAINFRAME	28480	03458-00106
MP13	03458-47901	2	1	BEZEL-REAR	28480	03458-47901
MP14	1390-0793	6	4	FASTENER-CAPTIVE SCREW M4 X 0.7 THD 9.0	N/A	ORDER BY DESCRIPTION
B1	03458-68501	2	1	ASSEMBLY-FAN	28480	03458-68501
MP15	0624-0530	5	2	SCREW-TPG 8-16 .375-IN-L6 PAN-HD-TORX	93907	ORDER BY DESCRIPTION
MP16	3150-0300	5	1	FILTER-AIR NYLON 2.3-IN-OD .75-IN-LG	N/A	ORDER BY DESCRIPTION
MP17	0515-0372	2	2	SCREW-MACHINE ASSEMBLY M3 X 0.5 8MM-LG	93907	ORDER BY DESCRIPTION
MP18	03458-00602	2	1	SHIELD-BOTTOM	28480	03458-00602
MP19	0515-1604	5	2	SCREW-MACH M3.5 X 0.6 6MM-LG	93907	ORDER BY DESCRIPTION
MP20	03458-04102	5	1	COVER-BOTTOM	28480	03458-04102
MP21	0515-0372	2	1	SCREW-MACHINE ASSEMBLY M3 X 0.5 8MM-LG	93907	ORDER BY DESCRIPTION
MP22	5040-7201	8	4	FOOT	28480	5040-7201
MP23	1460-1345	5	2	TILT-STAND SST	N/A	ORDER BY DESCRIPTION

Contents

Section 4 Assembly Level Troubleshooting

INTRODUCTION	1
TEST EQUIPMENT REQUIRED	1
HP 3458A ADJUSTMENTS/CALIBRATION	1
ASSEMBLIES REMOVAL/INSTALLATION PROCEDURES	2
HP 3458A TECHNICAL DESCRIPTION	2
General Description	2
Technical Description	2
Outguard Section	3
Main Controller	4
HP-IB Circuitry	4
Front Panel Circuitry	4
Isolation Logic	4
Inguard Section	4
Input Switching and Signal Conditioning	4
DC Ranging, DC Amplifier, and Autocal	4
AC Ranging, AC Amplifier, AC to DC Converter, and Autocal	5
Current Ranging	5
Ohms Current Source and Autocal	5
Reference	5
Analog-to-Digital (A/D) Converter	6
Inguard Controller	6
ASSEMBLY LEVEL TROUBLESHOOTING	6
HP 3458A Failures	6
Turn-On Failures	6
HP 3458A Inoperative with Blank Display	6
HP 3458A Inoperative with Unintelligible Messages in Display	7
Isolator Failure	7
RAM Failures	8
Self-Test Failures	8
General	8
Self-Test Failure Indication	8
Self-Test Error Messages	8
Self-Test Failure Troubleshooting	9
"TEST VALUE OUT OF RANGE" Error Message	9
Performance Test Failures	9
Miscellaneous Failures	11
HP-IB Failure	12
Ext Out Failure	12
Ext Trig Failure	12
Fan Inoperative	13
Long Term Stability Failure	13

POWER SUPPLIES TROUBLESHOOTING	13
Outguard Power Supplies Troubleshooting	15
Inguard Power Supplies Troubleshooting	15

SECTION 4

ASSEMBLY LEVEL TROUBLESHOOTING

INTRODUCTION

This section provides a technical description and assembly level troubleshooting procedures for the HP 3458A Multimeter.

WARNING

Only personnel with knowledge of electronic circuitry and an awareness with the hazards involved should test and troubleshoot the instrument.

CAUTION

To prevent static zap of ICs, always observe anti-static techniques when assemblies are handled or serviced. Refer to Section 3 of this manual for more information on static zap

TEST EQUIPMENT REQUIRED

You need the following equipment:

1. A a 4 1/2 digit digital multimeter that can measure +5 V, +18 V, and -18 V DC. This is only used to check and troubleshoot the power supplies.
2. A computer with HP-IB capability to check the HP 3458A's HP-IB operation. This is only required for an HP-IB failure.
3. An oscilloscope or logic probe. This is only required for an Ext Out failure.

HP 3458A ADJUSTMENTS/CALIBRATION

Instrument adjustments/calibration must be performed whenever a printed circuit board assembly has been replaced or removed from the instrument. Removal or replacement of some assemblies only requires internal calibration (by executing the "ACAL ALL" command). Others need complete adjustments (for example, Offset, DC Gain, etc.). It is also good practice to execute the "ACAL ALL" command after the covers have been removed and replaced on the instrument.

Table 4-1 lists the HP 3458A assemblies and the required adjustments/calibration after assembly replacement. For information on how to adjust/calibrate the HP 3458A, refer to the HP 3458A Calibration Manual.

municates with instruments and controllers connected to the Hewlett-Packard Interface Bus (HP-IB).* The outguard circuitry is explained as follows.

Main Controller

The Main Controller consists of a microprocessor, program ROMs, storage RAMs, calibration RAMs, and other associated circuitry. It controls the measurement operation of the instrument, communicates with the front panel (keyboard and display) and HP-IB circuitry, performs the math operations, and calculates for the correct measurements. The correct measurements are calculated using the calibration constants in the calibration RAM which were stored during instrument adjustment.

HP-IB Circuitry

The HP-IB circuitry provides communication between the HP 3458A and other instruments and controllers connected to the HP-IB. Instrument control commands are transferred to the main controller and measurement data is transferred from the main controller through the HP-IB circuitry.

Front Panel Circuitry

The front panel circuitry consists of keyboard and display circuitry. The main controller sends display data to the display circuitry to be displayed on the front panel. The keyboard circuitry interrupts the main controller when a key is pressed. The keyboard circuitry also sends data to the main controller that determines which key is pressed to perform the appropriate action.

Isolation Logic

Since both the outguard and inguard circuitry are referenced to two different circuit grounds, they must be isolated from each other. To maintain this isolation, direct connections for communications cannot be used. The isolation logic is used to provide communication between the two circuits, while keeping them isolated from each other. The isolation logic uses fiber optic cables to transfer data between the inguard and outguard.

Inguard Section

The inguard circuitry consists of all the analog measurement circuitry (DC circuitry, AC converter, etc.), analog/digital (A/D) converter, inguard controller, and power supply. The inguard circuitry performs all instrument measurements and converts the analog measurement data into digital measurement data. This digital measurement data is transferred to the outguard circuitry through the isolation logic. The inguard circuitry is explained as follows.

Input Switching and Signal Conditioning

This circuitry connects the signal path from the front/rear input terminals to the appropriate DC, AC, or Ohms circuitry. The circuitry also provides the means for an Autozero measurement. In an Autozero measurement, the input of the DC and AC amplifiers is connected to ground for an offset measurement. This measurement is stored in memory and subtracted from the subsequent measurement taken at the front/rear terminals.

DC Ranging, DC Amplifier, and Autocal

The A/D converter requires the same full scale input voltage for full scale inputs on all ranges. For example, a 10 V full scale input is required for all full scale inputs on the 0.1 V, 1 V, 100 V, and 1000 V

*Hewlett-Packard's implementation of IEEE 488-1978 and ANSI MC 1.1

ranges. This requirement is met by the DC circuitry (DC amplifier in conjunction with the DC ranging circuitry). For the lower 1 V and 0.1 V ranges, the circuitry amplifies the input voltage by a gain of X10 and X100, respectively. For the 10 V range, the gain is 1. For the higher 100 V and 1000 V ranges, the circuitry attenuates the inputs by 100. This results in full scale voltages of 1 V and 10 V for the 100 V and 1000 V ranges, respectively. The 1 V and 10 V amplifier gains will then be used for these ranges.

The DC autocal constants are also generated by the Autocal circuitry in conjunction with the DC ranging and DC amplifier circuitry.

AC Ranging, AC Amplifier, AC to DC Converter, and Autocal

The A/D converter also requires the same full scale input voltage for full scale inputs on all AC volts and AC + DC volts ranges. In addition, the inputs to the A/D converter must be DC volts and not AC volts. Both of these requirements are met using the AC circuitry (AC ranging, AC amplifier, and AC to DC converter). The AC and AC + DC volts to DC volts conversion method used is True RMS. This method is used since the converter must convert both DC and AC voltages.

The AC autocal constants are also generated by the Autocal circuitry in conjunction with the AC ranging, AC amplifier, and AC to DC converter circuitry.

The AC circuitry is also used for track/hold measurements. Although these measurements are DC volts measurements, the AC circuitry is used due to its higher bandwidth. Track/hold requires a higher bandwidth than the DC circuitry provides.

Current Ranging

The HP 3458A measures current by measuring the voltage across a shunt resistor. This voltage and the shunt resistor value are then used to calculate the current. The outguard circuitry calculates the correct current value.

The current ranging circuitry is composed of the shunt resistors for the different current ranges and the switches to select the ranges. Depending on the type of current measured (AC or DC current), the circuit is also used to apply the measured voltage to the appropriate circuitry (AC or DC circuitry).

Ohms Current Source and Autocal

Resistance measurements are made by applying a known current to the unknown resistor and then measuring the voltage drop across it. From this the correct resistance is then calculated by the outguard.

The ohms current source circuitry generates the different currents for resistance measurement ranges. The DC voltage measurement across the unknown resistance is made by the DC ranging and DC amplifier circuitry.

The ohms autocal constants are also generated by the Autocal circuitry in conjunction with the ohms current source.

Reference

The reference circuit serves two functions. It provides a very stable reference voltage for the A/D converter and the Ohms current source. This voltage is necessary for accurate analog-to-digital conversion and to generate accurate currents for resistance measurements. The reference voltage is generated by a diode selected at the factory for excellent long term stability.

Analog-to-Digital (A/D) Converter

The A/D converter converts the applied DC voltage to digital data. It uses a multi-slope conversion process to convert analog voltages to digital data. The digital data is sent to the outguard through the isolation logic circuitry.

Inguard Controller

The inguard controller controls the measurement process. It receives function and range data from the outguard and then sets the appropriate switches in the inguard. The inguard controller also controls the operation of the A/D converter.

ASSEMBLY LEVEL TROUBLESHOOTING

HP 3458A Failures

To troubleshoot the HP 3458A, first determine what the failure is. Then use the information in the following paragraphs to determine the defective assembly.

Failures can show up in a variety of ways. Some failures are obvious, like a completely inoperative instrument or a self test failure. Other failures may only show up during the performance tests. Others yet will only show up under certain conditions, like the instrument working from the front panel but not from remote. In most cases, the HP 3458A failures can be separated into the following major categories.

1. Turn-On Failures -- these failures are as follows:
 - a. HP 3458A Inoperative with Blank Display
 - b. HP 3458A Inoperative with Unintelligible Messages in Display
 - c. Isolator Failure
 - d. RAM Failure
2. Self-Test Failures -- these are detected during the HP 3458A's self-test.
3. Performance Tests Failures -- these are detected during the HP 3458A's performance test,
4. Miscellaneous Failures -- these failures are as follows:
 - a. HP-IB Failure (Self-Test passes)
 - b. Ext Out Failure
 - c. Ext Trig Failure
 - d. Fan Inoperative
 - e. Long Term Stability Failure

Turn-On Failures

These failures normally show up when the instrument is first turned on and it attempts to go through its power-on self-test. The following paragraphs explain these failures and how to troubleshoot them.

HP 3458A Inoperative with Blank Display

A blank display can indicate two things: either the instrument is completely inoperative or the display is defective. Do the following:

1. Turn the instrument on. The instrument should beep once and then go through its power-on self-test. During this time, you should hear some relays switching. When completed, the instrument will beep once again. This indicates that the instrument has completed its power-on self-test.
2. If the above power-on self-test sequence takes place (i.e., a beep is output and the relays switch), the Display Logic (A7) assembly is most likely defective. Go to the Assemblies Removal/Installation Procedures in Section 3 of this manual to replace the Display Logic (A7) assembly.
3. If the power-on self-test sequence does not take place, first check for a defective outguard power supply. Go to the Power Supplies troubleshooting procedures in this section of the manual to check the supplies.
4. If the outguard power supplies are defective, go to the Assemblies Removal/Installation Procedures in Section 3 of this manual to replace the Outguard Power Supply (A6) assembly.
5. If the outguard power supplies check good, the Outguard Controller (A5) assembly may be defective. Go to the Assemblies Removal/Installation Procedures in Section 3 of this manual to replace the Outguard Controller (A5) assembly.
6. If after replacement of the Outguard Controller (A5) assembly the instrument is still inoperative, the logic circuitry on the Outguard Power Supply (A6) assembly may be causing the failure. Go to the Assemblies Removal/Installation Procedures in Section 3 of this manual to replace the Outguard Power Supply (A6) assembly.

HP 3458A Inoperative with Unintelligible Messages in Display

This normally indicates that the Display Logic is probably working but that the Outguard Logic may be inoperative. Do the following:

1. First check for a defective outguard power supply. Go to the Power Supplies troubleshooting procedures in this section of the manual to check the supplies.
2. If the outguard power supplies check good, the Outguard Controller (A5) assembly may be defective. Go to the Assemblies Removal/Installation Procedures in Section 3 of this manual to replace the (A5) Outguard Controller assembly.
3. If after replacement of the (A5) Outguard Controller assembly the instrument is still inoperative, the logic circuitry on the Outguard Power Supply (A6) assembly may be causing the failure. Go to the Assemblies Removal/Installation Procedures in Section 3 of this manual to replace the Outguard Power Supply (A6) assembly.

Isolator Failure

For isolation logic failures, the message "ISOLATOR FAILURE" will be displayed after the power-on self-test is completed. The instrument then locks up and no front panel/remote control is possible. Either the inguard or outguard isolation logic can cause the failure. Do the following:

1. Use the Covers Removal/Installation procedures in Section 3 of this manual to remove the instrument's bottom cover and bottom shield.
2. Turn the instrument on. Go to the Power Supplies troubleshooting procedures in this section of the manual to check both the inguard and outguard power supplies.

3. If the power supplies check good, the failure can either be on the Outguard Power Supply (A6) assembly or the A/D Converter and Inguard Logic (A3) assembly. These assemblies can cause the failure since the isolation logic circuitry is on both assemblies and the self-test is unable to differentiate between the failures on the two assemblies. In addition to these, the (A5) Outguard Controller assembly could also cause the failure. However, most failures will most be caused by the A3 or A6 assemblies.

4. Try replacing the Outguard Power Supply (A6) assembly first. Go to the Assemblies Removal/Installation Procedures in Section 3 of this manual to replace the assembly.

5. If after replacing the Outguard Power Supply (A6) assembly the test still fails, try replacing the A/D Converter and Inguard Logic (A3) assembly. Go to the Assemblies Removal/Installation Procedures in Section 3 of this manual to replace the assembly.

6. If after replacing the Outguard Power Supply (A6) assembly the test still fails, try replacing the (A5) Outguard Controller assembly. Go to the Assemblies Removal/Installation Procedures in Section 3 of this manual to replace the assembly.

RAM Failures

These failures show up when the checksum of either the RAM or the Calibration RAM is incorrect. If a failure occurs, a message indicating that the checksum is incorrect will be displayed. Since both RAMs are located on the Outguard Controller (A5) assembly, replace that assembly for any RAM failure. Use the Assemblies Removal/Installation Procedures in Section 3 of this manual to replace the assembly.

Self-Test Failures

General

The HP 3458A self-tests perform very extensive tests on the instrument circuitry so that most hardware or calibration self-test failures will be detected by these tests.

Self-test failures can show up either during the power-on self-test or during the front panel selectable self-test. The power-on self-test is automatically performed after the instrument is turned on. The complete self-test must be selected from the front panel. To select this test, press the blue "SHIFT" key and then the "Test" (left arrow) key.

Self-Test Failure Indication

The power-on and selectable self-tests use two different ways to indicate failures. With the power-on test, the "ERR" annunciator in the display normally turns on to indicate that a test has failed. In addition to the "ERR" annunciator, the message "SELF TEST FAILED" will also be displayed.

Self-Test Error Messages

Any time the HP 3458A detects a self-test failure, a corresponding error message is stored into the auxiliary error registers. To determine what failed, this error message must be retrieved from the registers and displayed. To display the message, press the blue "SHIFT" key and then the "Error" key (on the NUMERIC/USER keyboard). Once the message is displayed, it is then erased from the registers. Because of this, make sure you note the complete message before continuing. Use the right arrow key to view the complete message.

An error message is composed of two different parts, a number and a corresponding message that explains the failure. For example, the error message for an AC board failure looks like the following:

202, "HARDWARE FAILURE -- SLAVE TEST: AC BOARD"

Note: Remember, you need to use the left and right arrow keys to view the complete message.

The first number (2) in the message shows that this is a "200" series message. All hardware errors are stored as "200" series numbers. The other two numbers (02) show in what auxiliary error register the message is located. In the example, this is auxiliary register 2 (as in number 02).

This number also determines in which order the error messages are to be stored and displayed. This is done since more than one error message can be detected and stored into the registers. The lowest number is always stored and displayed first. Once it is displayed, the next lowest number can then be displayed, and so on. Use the blue "SHIFT" and "Error" keys combination to display the other messages.

Self-Test Failure Troubleshooting

Before doing any self-test failure troubleshooting, go to the Power Supplies Troubleshooting procedures in this section of the manual to check the Outguard and Inguard Power Supplies.

If the power supplies check good, use the procedure in the previous paragraph to display the error messages. Then refer to Table 4-2 to determine the most likely cause of the self-test failure. Do this for all error messages recorded in the error registers. Refer to the Assemblies Removal/Installation Procedures in Section 3 of this manual to replace a defective assembly.

"TEST VALUE OUT OF RANGE" Error Message

This error message indicates that a test did not meet certain pre defined limits. The number displayed next to the message indicates the test limit that was exceeded during the test.

The number can be used to determine the assembly that caused the test to fail. Numbers from 62 through 189 indicate a failure on the DC Circuitry (A1) assembly. Numbers from 190 and above indicate a failure on the AC Converter (A2) assembly. Refer to the Assemblies Removal/Installation Procedures in Section 3 of this manual to replace a defective assembly.

Performance Test Failures

Performance test failures are failures that may not be detected during the self-test but are detected during the performance tests. These failures may not be detected by the self-test due to the high accuracy of the HP 3458A.

Before assuming that a performance test has failed, you must make sure your test equipment and performance test methods have sufficient accuracy to check the HP 3458A. The HP 3458A is very accurate and needs very accurate standards to determine if a performance test has failed or not. Be sure to read the accuracy requirements in the HP 3458A Calibration Manual before troubleshooting performance test failures.

If you are sure that the HP 3458A fails a performance test, determine what function is inaccurate and then replace the appropriate assembly. The following lists the functions and probable corresponding assemblies.

1. DC Volts Function Failure -- DC Circuitry (A1) assembly.
2. DC Current Function Failure -- DC Circuitry (A1) assembly.
3. OHMS Function Failure -- DC Circuitry (A1) assembly.
4. AC Volts Function Failure -- AC Converter (A2) assembly.
5. AC Current Function Failure -- AC Converter (A2) assembly.

Table 4-2. Self-Test Error Messages and Probable Causes

Error Number	Error Message	Probable Cause	Ref Desig	Assembly Part Number
200	ISOLATOR (RECOVERED)	A/D Converter and Inguard Logic Outguard Controller	A3 A5	03458-66503 03458-66505
200	ISOLATOR DOES NOT RESPOND	A/D Converter and Inguard Logic Outguard Logic	A5 A3	03458-66515 03458-66503
200	UNEXPECTED SLAVE PROCESSOR RESET	A/D Converter and Inguard Logic	A5 A3	03458-66505 03458-66503
201	NONVOLATILE RAM DTACK	Outguard Controller	A5	03458-66505
201	HPIB DTACK	Outguard Controller	A5	03458-66505
201	TIMER DTACK	Outguard Controller	A5	03458-66505
201	ISOLATOR DTACK	Outguard Controller	A5	03458-66505
202	SLAVE SELF TEST	A/D Converter and Inguard Logic	A3	03458-66503
202	SLAVE TEST: ISOLATOR DATA	A/D Converter and Inguard Logic	A3	03458-66503
202	SLAVE TEST: INTR DATA	AC Converter	A2	03458-66502
202	SLAVE TEST: DC BOARD	DC Circuitry	A1	03458-66501
202	SLAVE TEST: AC BOARD	AC Converter	A2	03458-66502
202	SLAVE TEST: OVERLOAD	DC Circuitry	A1	03458-66501
202	SLAVE TEST: GATE ARRAY	A/D Converter and Inguard Logic	A3	03458-66503
202	SLAVE TEST: CONVERGENCE	A/D Converter and Inguard Logic	A3	03458-66503
202	SLAVE TEST: INTERPOLATOR	DC Circuitry	A1	03458-66501
202	SLAVE TEST: INTERPOLATOR	A/D Converter and Inguard Logic	A3	03458-66503
204	DC VOS DAC CONVERGENCE	DC Circuitry	A1	03458-66501
204	PRECHARGE DAC CONVERGENCE	DC Circuitry	A1	03458-66501
204	MC DAC CONVERGENCE	AC Converter	A2	03458-66502
204	FLATNESS DAC CONVERGENCE	AC Converter	A2	03458-66502
204	LEVEL DAC CONVERGENCE	AC Converter	A2	03458-66502
204	AC VOS DAC CONVERGENCE	AC Converter	A2	03458-66502
204	ATTEN HF DAC CONVERGENCE	AC Converter	A2	03458-66502
204	AC AMP HF DAC CONVERGENCE	AC Converter	A2	03458-66502
204	INTERPOLATOR LEVEL SEEK	A/D Converter and Inguard Logic	A3	03458-66503
204	INTEPOLATOR DAC CONVERGENCE	A/D Converter and Inguard Logic	A3	03458-66503
204	REFERENCE CONTROL LOOP FAILURE	A/D Converter and Inguard Logic	A3	03458-66503
205	TEST VALUE OUT OF RANGE	See text		
206	HPIB	Outguard Controller	A5	03458-66505
206	HPIB ASM	Outguard Controller	A5	03458-66505
206	HPIB ASM	Outguard Controller	A5	03458-66505

Table 4-2. Self-Test Error Messages and Probable Causes (Cont)

Error Number	Error Message	Probable Cause	Ref Desig	Assembly Part Number
207	UART	Outguard Controller	A5	03458-66505
207	UART INTR	Outguard Controller	A5	03458-66515
208	TIMER	Outguard Controller	A5	03458-66505
208	TIMER INTR	Outguard Controller	A5	03458-66515
210	ROM 0 LOW CHECKSUM	Outguard Controller	A5	03458-66505
210	ROM 1 LOW CHECKSUM	Outguard Controller	A5	03458-66515
210	ROM 2 LOW CHECKSUM	Outguard Controller	A5	03458-66505
211	ROM 0 HIGH CHECKSUM	Outguard Controller	A5	03458-66505
211	ROM 1 HIGH CHECKSUM	Outguard Controller	A5	03458-66515
211	ROM 2 HIGH CHECKSUM	Outguard Controller	A5	03458-66505
212	NONVOLATILE RAM HIGH	Outguard Controller	A5	03458-66505
212	NONVOLATILE RAM LOW	Outguard Controller	A5	03458-66515
213	OPTIONAL RAM 0 HIGH	Outguard Controller	A5	03458-66505
214	OPTIONAL RAM 0 LOW	Outguard Controller	A5	03458-66515
214	OPTIONAL RAM 1 HIGH	Outguard Controller	A5	03458-66505
214	OPTIONAL RAM 1 LOW	Outguard Controller	A5	03458-66515

Refer to the Assemblies Removal/Installation Procedures in Section 3 of this manual to replace a defective assembly.

Miscellaneous Failures

The following failures are those that are not detected by either the self-tests or the performance tests.

HP-IB Failure (Self-Test passes)

This failure is normally caused by a defective HP-IB Connector. Try cleaning the connector. If still inoperative, try replacing the Outguard Controller (A5) assembly. Go to the Assemblies Removal/Installation Procedures in Section 3 of this manual to replace the assembly.

Ext Out Failure

This failure can be caused by a defective cable or an inoperative isolation logic circuitry. Note that the Ext Out function can be disabled by the "EXTOUT 0" command. Be sure the function is enabled before troubleshooting the failure. To enable the function, reset the instrument.

To troubleshoot an Ext Out failure, do the following:

1. Use the Covers Removal/Installation Procedures in Section 3 of this manual to remove the instrument's bottom cover.
2. Refer to Figure 4-2 to locate the Ext Out/Ext Trig cable plugged in on the Outguard Power Supply (A6) assembly. Unplug the cable from socket P301.
3. Connect an oscilloscope (a logic probe can also be used) to the Ext Out connection on the Ext Out/Ext Trig connector (P301). The Ext Out connection is on the connector's outside pin facing the inguard.
4. Turn the instrument on and wait until it completes its self-test. When the instrument starts to trigger, a 1 μ S negative going pulse should be detected by the oscilloscope (or logic probe) at each trigger.
5. If a pulse is detected, check the cable going to the Ext Out connector on the rear panel.
6. If no pulse is detected, the isolation logic circuitry or the A/D Converter and Inguard Logic (A3) assembly may be defective. Try replacing the A/D Converter and Inguard Logic (A3) assembly first. Then, if still inoperative, try replacing the Outguard Power Supply (A6) assembly. Refer to the Assemblies Removal/Installation Procedures in Section 3 of this manual to replace the assemblies.

Ext Trig Failure

This failure can be caused by a defective cable or an inoperative isolation logic circuitry.

To troubleshoot an Ext Trig failure, do the following:

1. Use the Covers Removal/Installation Procedures in Section 3 of this manual to remove the instrument's bottom cover.
2. Refer to Figure 4-2 to locate the Ext Out/Ext Trig cable plugged in on the Outguard Power Supply (A6) assembly. Unplug the cable from socket P301.
3. Turn the instrument on and wait until it completes its self-test. Then select the EXT TRIG mode by executing the following:
 - a. Press the "Trig" key on the MENU keyboard. "TRIG" should now be displayed with a flashing cursor next to it.
 - b. Press the "UP ARROW" key on the FUNCTION/RANGE keyboard three times. "TRIG EXT" should now be displayed.

c. Press the "Enter" key on the NUMERIC/USER keyboard. The instrument should now be in the external trigger mode.

4. While viewing the HP 3458A display, temporarily connect a cliplead between chassis ground and the Ext Trig connection on the Ext Out/Ext Trig connector (P301). The Ext Trig connection is on the connector's outside pin facing the instrument's outside edge.
5. The instrument should now trigger and each time the pin is connected to ground.
6. If triggering occurs, check the cable going to the Ext Trig connector on the rear panel.
7. If no triggering occurs, the isolation logic circuitry or the A/D Converter and Inguard Logic (A3) assembly may be defective. Try replacing the A/D Converter and Inguard Logic (A3) assembly first. Then, if still inoperative, try replacing the Outguard Power Supply (A6) assembly. Refer to the Assemblies Removal/Installation Procedures in Section 3 of this manual to replace the assemblies.

Fan Inoperative

This failure can be caused by the fan power supply, the fan cable, or by the fan itself. The fan uses a +15 V power supply to operate. This power supply is on the Outguard Power Supply (A6) assembly. Do the following:

1. Use the Covers Removal/Installation Procedures in Section 3 of this manual to remove the instrument's bottom cover.
2. Refer to Figure 4-2. Unplug the 2 pin cable from socket P3. The cable is connected to the fan.
3. Turn the instrument on. Use a digital multimeter to measure for approximately +15 V at socket P3, as shown in Figure 4-2.
4. If the voltage is good, the fan or fan cable may be defective. Since the fan and cable are considered one assembly, replace the complete fan assembly.
5. If the voltage is wrong, go to the Assemblies Removal/Installation Procedures in Section 3 of this manual to replace the Outguard Power Supply (A6) assembly.

Long Term Stability Failure

A Long Term Stability failure is normally detected during a DC voltage performance test. For instance, the instrument fails the DC performance test before the completion of the period (for example, 24 hours to 2 years) corresponding to the test limits against which the instrument is tested. This failure may be because of the HP 3458A's long term stability. A defective DC Reference (A9) assembly causes this failure. Go to the Assemblies Removal/Installation Procedures in Section 3 of this manual to replace the assembly.

POWER SUPPLIES TROUBLESHOOTING

Before troubleshooting the power supplies, do the following:

1. Make sure the power line voltage select switches are in the correct position. Also make sure the correct power fuse is installed and that the fuse is good. Refer to Section 2, Table 2-1 for the correct switch positions and fuses.

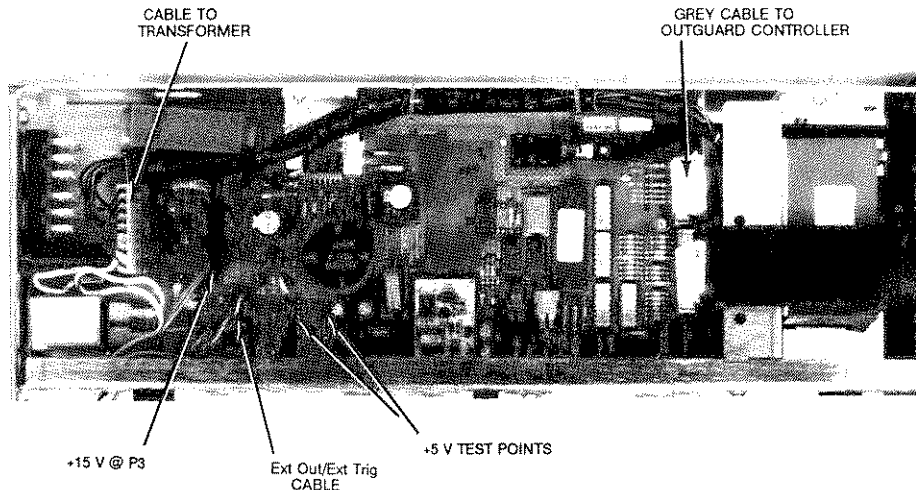

Figure 4-2. Outguard Power Supply

2. If the switch positions are correct and the fuse is good, go to the appropriate procedures to troubleshoot the suspect power supply.
3. If the ac power fuse is blown, try replacing the fuse first. If the fuse still blows, do the following:
 - a. Use the Covers Removal/Installation Procedures in Section 3 of this manual to remove the instrument's top/bottom cover and bottom shield.
 - b. Refer to Figure 4-2 to locate the 8 pin cable that connects the Outguard Power Supply (A6) assembly to the power transformer. Unplug the cable at the power supply assembly.
 - c. Locate the 5 pin cable that connects the Inguard Power Supply (A4) assembly to the power transformer. Unplug the cable at the power supply assembly.
 - d. Replace the ac power fuse with a new one. Apply AC power to the HP 3458A and turn it on.
 - e. If the fuse still blows, replace the power transformer.
 - f. If the fuse remains good, either the Outguard Power Supply (A6) or the Inguard Power Supply (A4) is defective. Continue with the next step.
 - g. Turn the instrument off. Locate the 5 pin cable connected to the power transformer. Line up the cable with the socket on the Inguard Power Supply (A4) assembly. Then plug it in.
 - h. Turn the instrument on.
 - i. If the fuse blows again, use the Assemblies Removal/Installation Procedures in Section 3 of this manual to replace the Inguard Power Supply (A4) assembly.

j. If the fuse is good, use the Assemblies Removal/Installation Procedures in Section 3 of this manual to replace the Outguard Power Supply (A6) assembly.

Outguard Power Supplies Troubleshooting

Do the following:

1. Use the Covers Removal/Installation Procedures in Section 3 of this manual to remove the instrument's bottom cover, if not previously removed.
2. Refer to Figure 4-2. With the test digital multimeter, check for +5 V \pm .05 V at the test points shown in the figure.
3. If the voltages are good, the Outguard Power Supply assembly is good.
4. If a voltage is high, the Outguard Power Supply (A6) assembly is defective. Go to the Assemblies Removal/Installation Procedures in Section 3 of this manual to replace the assembly.
5. If any voltage is low, the HP Outguard Controller (A5) assembly may be loading down the power supply. Continue with the next step.
6. Refer to Figure 4-2. Unplug the grey 20 pin cable connected to the Outguard Controller (A5) assembly.
7. If the power supply voltages are now good, the Outguard Controller (A5) assembly is defective. Go to the Assemblies Removal/Installation Procedures in Section 3 of this manual to replace the assembly.
8. If the voltage is still low, the Outguard Power Supply (A6) assembly is defective. Go to the Assemblies Removal/Installation Procedures in Section 3 of this manual to replace the assembly.

Inguard Power Supplies Troubleshooting

Do the following:

1. Use the Covers Removal/Installation Procedures in Section 3 of this manual to remove the instrument's bottom cover and bottom shield, if not previously removed.
2. Refer to Figure 4-3. With the test digital multimeter, check for +5 V (\pm .05 V), +18 V (\pm 1.8 V), and -18 V (\pm 1.8 V) at the test points shown in the figure.
3. If all voltages are good, the power supply assembly is good.
4. If a voltage is high, the Inguard Power Supply (A4) assembly is defective. Go to the Assemblies Removal/Installation Procedures in Section 3 of this manual to replace the assembly.
5. If a voltage is low, other assemblies in the inguard may be loading down the power supply. Continue with the next step.
6. Refer to Figure 4-3 to locate the grey 20 pin cable that connects the Inguard Power Supply (A4) assembly to the DC Circuitry (A1) assembly. Unplug the cable at the power supply assembly.
7. If the power supply voltage that was low is now good, the DC Circuitry (A1) assembly is defective. Go to the Assemblies Removal/Installation Procedures in Section 3 of this manual to replace the assembly.

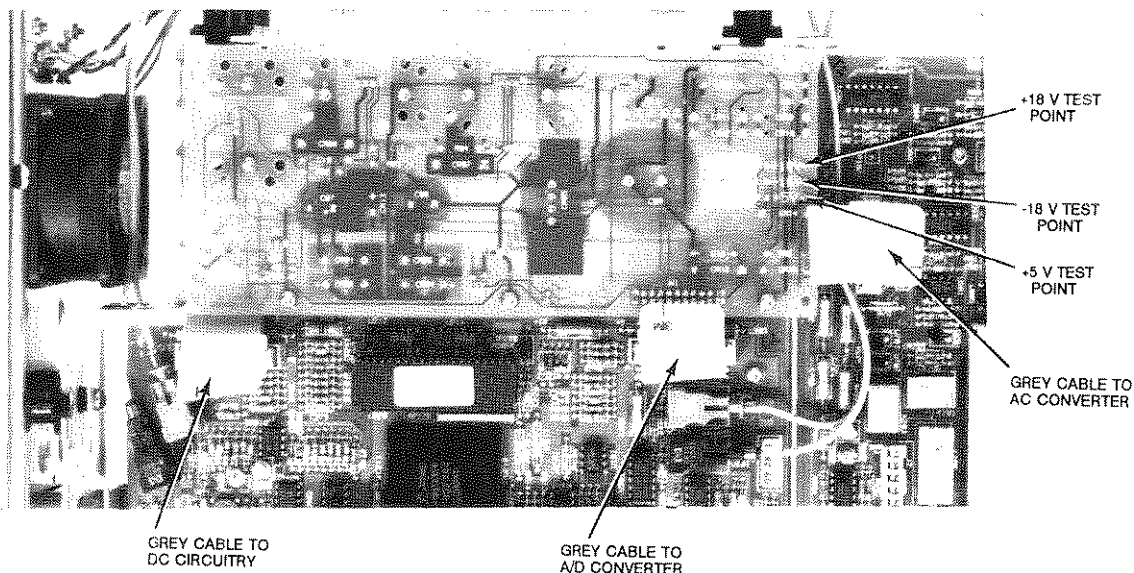

Figure 4-3. Inguard Power Supply

8. If the power supply voltage is still low, locate the grey 20 pin cable that connects the Inguard power Supply (A4) assembly to the AC Converter (A2) assembly. Unplug the cable at the power supply assembly.
9. If the power supply voltage is now good, the AC Converter (A2) assembly is defective. Go to the Assemblies Removal/Installation Procedures in Section 3 of this manual to replace the assembly.
10. If the power supply voltage is still low, locate the grey 20 pin cable that connects the Inguard Power Supply (A4) assembly to the A/D Converter and Inguard Logic (A3) assembly. Unplug the cable at the power supply assembly.
11. If the power supply voltage is now good, the A/D Converter and Inguard Logic (A3) assembly is defective. Go to the Assemblies Removal/Installation Procedures in Section 3 of this manual to replace the assembly.
12. If the power supply voltage is still low, the Inguard Power Supply (A4) assembly is defective. Go to the Assemblies Removal/Installation Procedures in Section 3 of this manual to replace the assembly.



SALES & SUPPORT OFFICES

Arranged alphabetically by country

Product Line Sales/Support Key

Key Product Line

A Analytical

CM Components

C Computer Systems

E Electronic Instruments & Measurement Systems

M Medical Products

P Personal Computation Products

* Sales only for specific product line

** Support only for specific product line

IMPORTANT: These symbols designate general product line capability. They do not insure sales or support availability for all products within a line, at all locations. Contact your local sales office for information regarding locations where HP support is available for specific products.

HEADQUARTERS OFFICES

If there is no sales office listed for your area, contact one of these headquarters offices.

NORTH/CENTRAL AFRICA

Hewlett-Packard S.A.
7, rue du Bois-du-Lan
CH-1217 MEYRIN 1, Switzerland
Tel: (022) 83 12 12
Telex: 27835 hmea
Cable: HEWPACKSA Geneve

ASIA

Hewlett-Packard Asia Ltd.
47/F, 26 Harbour Rd.,
Wanchai, HONG KONG
G.P.O. Box 863, Hong Kong
Tel: 5-8330833
Telex: 76793 HPA HX
Cable: HPASIAL TD

CANADA

Hewlett-Packard (Canada) Ltd.
6877 Goreway Drive
MISSISSAUGA, Ontario L4V 1M8
Tel: (416) 678-9430
Telex: 069-8644

EASTERN EUROPE

Hewlett-Packard Ges.m.b.h.
Liebiggasse 1
P.O.Box 72
A-1222 VIENNA, Austria
Tel: (222) 2500-0
Telex: 1 3 4425 HEPA A

NORTHERN EUROPE

Hewlett-Packard S.A.
V. D. Hooplaan 241
P.O.Box 999
NL-1183 AG AMSTELVEEN
The Netherlands
Tel: 20 547999
Telex: 18 919 hpner

SOUTH EAST EUROPE

Hewlett-Packard S.A.
World Trade Center
110 Avenue Louis Casai
1215 Cointrin, GENEVA, Switzerland
Tel: (022) 98 96 51
Telex: 27225 hpser

MEDITERRANEAN AND MIDDLE EAST

Hewlett-Packard S.A.
Mediterranean and Middle East Operations
Atrina Centre
32 Kifissias Ave.
Paradissos-Amarousion, ATHENS
Greece
Tel: 682 88 11
Telex: 21-6588 HPAT GR
Cable: HEWPACKSA Athens

UNITED KINGDOM

Hewlett-Packard Ltd.
Nine Mile Ride
Easthampstead, WOKINGHAM
Berkshire, IRGII 3LL
Tel: 0344 773100
Telex: 848805

EASTERN USA

Hewlett-Packard Co.
4 Choke Cherry Road
ROCKVILLE, MD 20850
Tel: (301) 948-6370

MIDWESTERN USA

Hewlett-Packard Co.
5201 Tollview Drive
ROLLING MEADOWS, IL 60008
Tel: (312) 255-9800

SOUTHERN USA

Hewlett-Packard Co.
2000 South Park Place
ATLANTA, GA 30339
Tel: (404) 955-1500

WESTERN USA

Hewlett-Packard Co.
5161 Lankershim Blvd.
NORTH HOLLYWOOD, CA 91601
Tel: (818) 505-5600

OTHER INTERNATIONAL AREAS

Hewlett-Packard Co.
Intercontinental Headquarters
3495 Deer Creek Road
PALO ALTO, CA 94304
Tel: (415) 857-1501
Telex: 034-8300
Cable: HEWPACK

ALGERIA

Bureau de Liaison
Hewlett-Packard Alger
Villa des Lions
9, Hai Galloui
DZ-BORDJ EL BAHRI
Tel: 76 03 36
Telex: 51260 dliondz

ANGOLA

Telectra Angola LDA
Empresa Técnica de Equipamentos
Rua Barbosa Rodrigues, 41-1 DT.
Caixa Postal 6487

LUANDA

Tel: 35515,35516
Telex: 3134
E,P

ARGENTINA

Hewlett-Packard Argentina S.A.
Montaneses 2140/50
1428 BUENOS AIRES
Tel: 781-4059/69
Cable: HEWPACKARG
A,C,E,P
Biotron S.A.C.I.M.e.l.
Av. Paso Colon 221, Piso 9
1399 BUENOS AIRES
Tel: 541-333-490,
541-322-587
Telex: 17595 BIONAR

M

Laboratorio Rodriguez
Corswant S.R.L.

Misiones, 1156 - 1876

Bernal, Oeste

BUENOS AIRES

Tel: 252-3958, 252-4991

A

Argentina Esanco S.R.L.

A/ASCO 2328

1416 BUENOS AIRES

Tel: 541-56-1981, 541-59-2767

Telex: c/o 9400 HPARGENTINA

A

AUSTRALIA

Adelaide, South Australia

Office
Hewlett-Packard Australia Ltd.
153 Greenhill Road
PARKSIDE, S.A. 5063
Tel: 272-5911
Telex: 82536
Cable: HEWPARD Adelaide
A*,C,CM,E,P

Brisbane, Queensland

Office
Hewlett-Packard Australia Ltd.
10 Payne Road
THE GAP, Queensland 4061
Tel: 30-4133
Telex: 42133
Cable: HEWPARD Brisbane
A,C,CM,E,M,P

Canberra, Australia

Capital Territory

Office

Hewlett-Packard Australia Ltd.
Thynne Street, Fern Hill Park
BRUCE, A.C.T. 2617
P.O. Box 257,
JAMISON, A.C.T. 2614
Tel: 51 6999
Telex: 62650
Cable: HEWPARD Canberra
C,CM,E,P

Melbourne, Victoria

Office

Hewlett-Packard Australia Ltd.
31-41 Joseph Street
P.O. Box 221
BLACKBURN, Victoria 3130
Tel: 895-2895
Telex: 31-024
Cable: HEWPARD Melbourne
A,C,CM,E,M,P

Perth, Western Australia

Office

Hewlett-Packard Australia Ltd.
261 Stirling Highway
CLAREMONT, W.A. 6010
Tel: 383-2188
Telex: 93859
Cable: HEWPARD Perth
C,CM,E,P

Sydney, New South

Wales Office

Hewlett-Packard Australia Ltd.
17-23 Talavera Road
P.O. Box 308
NORTH RYDE, N.S.W. 2113
Tel: 888-4444
Telex: 21561
Cable: HEWPARD Sydney
A,C,CM,E,M,P

AUSTRIA

Hewlett-Packard Ges.m.b.h.
Verkaufsbuero Graz
Grottenhofstrasse 94
A-8052 GRAZ
Tel: (0316) 28-30-66
Telex: 312375
C,E

Hewlett-Packard Ges.m.b.h.

Liebiggasse 1
P.O. Box 72
A-1222 VIENNA
Tel: (0222) 2500-0
Telex: 134425 HEPA A
A,C,CM,E,M,P

BAHRAIN

Green Salon
P.O. Box 557

MANAMA

Tel: 255503-250950
Telex: 84419
P

Wael Pharmacy
P.O. Box 648

MANAMA

Tel: 256123
Telex: 8550 WAEI BN
E,M



SALES & SUPPORT OFFICES

Arranged alphabetically by country

JAPAN (Cont'd)

Yokogawa-Hewlett-Packard Ltd.
Meiji-Seimei Kokubun Bldg.
7-8 Kokubun, 1 Chome, Sendai
MIYAGI, 980
Tel: (0222) 25-1011
C,E

Yokogawa-Hewlett-Packard Ltd.
Gohda Bldg. 2F
2-10 Gohda 1 Chome
Okaya-Shi
NAGANO, 394
Tel: (0266) 23 0851
C,E

Yokogawa-Hewlett-Packard Ltd.
Nagoya Kokusai Center Building
47-1, Nagono, 1 Chome
Nakamura-ku
NAGOYA, 450
Tel: (052) 571-5171
C,CM,E,M

Yokogawa-Hewlett-Packard Ltd.
Sai-Kyo-Ren Building
1-2 Dote-cho
OHMIYA OHMIYA, Saitama 330
Tel: (0486) 45-8031

Yokogawa-Hewlett-Packard Ltd.
Chuo Bldg.,
4-20 Nishinakajima, 5 Chome
Yodogawa-ku
OSAKA, 532
Tel: (06) 304-6021
Telex: YHPOSA 523-3624
C,CM,E,M,P*

Yokogawa-Hewlett-Packard Ltd.
27-15, Yabe, 1 Chome
SAGAMIHARA Kanagawa, 229
Tel: 0427 59-1311

Yokogawa-Hewlett-Packard Ltd.
Motoshiro-cho Dai-ich Seimei Bldg. 3F
219-21 Motoshiro-cho,
Hamamatsu-shi
SHIZUOKA, 430
Tel: (0534) 56 1771
C,E

Yokogawa-Hewlett-Packard Ltd.
Daiichi Seimei Bldg.
7-1, Nishi Shinjuku, 2 Chome
Shinjuku-ku,**TOKYO** 160
Tel: 03-348-4611
C,E,M

Yokogawa Hewlett-Packard Ltd.
9-1, Takakura-cho
Hachioji-shi, **TOKYO**, 192
Tel: 0426-42-1261
C,E

Yokogawa-Hewlett-Packard Ltd.
29-21 Takaldo-Higashi, 3 Chome
Sugunami-ku **TOKYO** 168
Tel: (03) 331-6111
Telex: 232-2024 YHPTOK
C,CM,E,P*

Yokogawa Hokushin Electric
Corporation
Shinjuku-NS Bldg. 10F
4-1 Nishi-Shinjuku 2-Chome
Shinjuku-ku
TOKYO, 163
Tel: (03) 349-1859
Tel: J27584
A

Yokogawa Hokushin Electric Corp.
9-32 Nokacho 2 Chome
2 Chome Musashino-shi
TOKYO, 180
Tel: (0422) 54-1111
Telex: 02822-421 YEW MTK J
A

Yokogawa-Hewlett-Packard Ltd.
Meiji-Seimei
Utsunomiya Oodori Building
1-5 Oodori, 2 Chome
UTSUNOMIYA, Tochigi 320
Tel: (0286) 33-1153
C,E

Yokogawa-Hewlett-Packard Ltd.
Yasuda Seimei Nishiguchi Bldg.
30-4 Tsuruya-cho, 3 Chome
Kanagawa-ku, **YOKOHAMA** 221
Tel: (045) 312-1252
C,CM,E

JORDAN

Scientific and Medical Supplies Co.
P.O. Box 1387
AMMAN
Tel: 24907, 39907
Telex: 21456 SABCO JO
C,E,M,P

KENYA

ADCOM Ltd., Inc., Kenya
P.O.Box 30070
NAIROBI
Tel: 331955
Telex: 22639
E,M

KOREA

Samsung Hewlett-Packard Co. Ltd.
Dongbang Yeoeuido Building
12-16th Floors
36-1 Yeoeuido-Dong
Youngdaungpo-Ku
SEOUL
Tel: 784-4666, 784-2666
Telex: 25166 SAMSAN K
C,CM,E,M,P
Young In Scientific Co., Ltd.
Youngwha Building
547 Shinsa Dong, Kangnam-Ku
SEOUL 135
Tel: 546-7771
Telex: K23457 GINSCO
A

Dongbang Healthcare
Products Co. Ltd.
Suite 301 Medical Supply Center
Bldg. 1-31 Dongsungdong
Jong Ro-gu, **SEOUL**
Tel: 784-1171, 741-1641
Telex: K25706 TKBKO
Cable: TKBEEPKO
M

KUWAIT

Al-Khaidya Trading & Contracting
P.O. Box 830
SAFAT
Tel: 424910, 411726
Telex: 22481 AREEG KT
Cable: VISCOUNT
E,M,A

Gulf Computing Systems
P.O. Box 25125

SAFAT
Tel: 435969
Telex: 23648
P

Photo & Cine Equipment
P.O. Box 270

SAFAT
Tel: 2445111
Telex: 22247 MATIN KT
Cable: MATIN KUWAIT
P

W.J. Towell Computer Services
P.O. Box 5897

SAFAT
Tel: 2462640/1
Telex: 30336 TOWELL KT
C

LEBANON

Computer Information Systems S.A.L.
Chammas Building
P.O. Box 11-6274 Dora
BEIRUT
Tel: 89 40 73
Telex: 42309
C,E,M,P

LIBERIA

Unichemicals Inc.
P.O. Box 4509
MONROVIA
Tel: 224282
Telex: 4509
E

MADAGASCAR

Technique et Precision
12, rue de Nice
P.O. Box 1227
101 **ANTANANARIVO**
Tel: 22090
Telex: 22255
P

LUXEMBOURG

Hewlett-Packard Belgium S.A./N.V.
Bivd de la Woluwe, 100
Woluwedai
B-1200 **BRUSSELS**
Tel: (02) 762-32-00
Telex: 23-494 paloben bru
A,C,CM,E,M,P

MALAYSIA

Hewlett-Packard Sales (Malaysia)
Sdn. Bhd.
9th Floor
Chung Khiaw Bank Building
46, Jalan Raja Laut
50350 **KUALA LUMPUR**
Tel: 2986555
Telex: 31011 HPSM MA
A,C,E,M,P*
Protel Engineering
P.O.Box 1917
Lot 6624, Section 64
23/4 Pending Road
Kuching, **SARAWAK**
Tel: 36299
Telex: 70904 PROMAL MA
Cable: PROTELENG
A,E,M

MALTA

Phillip Toledo Ltd.
Birkirkara P.O. Box 11
Notabile Rd.

MRIEHEL

Tel: 447 47, 455 66, 4915 25
Telex: Media MW 649
E,M,P

MAURITIUS

Blanche Birger Co. Ltd.
18, Jules Koenig Street

PORT LOUIS

Tel: 20828
Telex: 4296
P

MEXICO

Hewlett-Packard de Mexico,
S.A. de C.V.
Rio Nio No. 4049 Desp. 12
Fracc. Cordoba
JUAREZ
Tel: 161-3-15-62
P
Hewlett-Packard de Mexico,
S.A. de C.V.
Condominio Kadereyta
Circuito del Mezon No. 186 Desp. 6
COL DEL PRADO - 76030 Qro.
Tel: 463-6-02-71
P

Hewlett-Packard de Mexico,
S.A. de C.V.
Monti Morelos No. 299
Fraccionamiento Loma Bonita 45060
GUADALAJARA, Jalisco
Tel: 36-31-48-00
Telex: 0684 186 ECOME
P
Microcomputadoras Hewlett-Packard,
S.A.
Monti Pelvoux 115
LOS LOMAS, Mexico, D.F.
Tel: 520-9127
P
Microcomputadoras Hewlett-Packard,
S.A. de C.V.
Monte Pelvoux No. 115
Lomas de Chapultepec, 11000
MEXICO, D.F.
Tel: 520-9127
P

Hewlett-Packard de Mexico,
S.A. de C.V.
Monte Pelvoux No. 111
Lomas de Chapultepec
11000 **MEXICO, D.F.**
Tel: 5-40-62-28, 72-66, 50-25
Telex: 17-74-507 HEWPACK MEX
A,C,CM,E,M,P
Hewlett-Packard De Mexico (Polanco)
Avenida Ejercito Nacional #579
2da y 3er piso
Colonia Granada 11560
MEXICO D.F.
Tel: 254-4433
P

Hewlett-Packard de Mexico,
S.A. de C.V.
Czda. del Valle
409 Ote. 4th Piso
Colonia del Valle
Municipio de Garza Garcia Nuevo Leon
66220 **MONTERREY**, Nuevo León
Tel: 83-78-42-40
Telex: 382410 HPMY
C

Infograficas y Sistemas del Noreste,
S.A.
Rio Orinoco #171 Oriente
Despacho 2001
Colonia Del Valle
MONTERREY
Tel: 559-4415, 575-3837
Telex: 483164
A,E

Hewlett-Packard de Mexico,
S.A. de C.V.
Blvd. Independencia No. 2000 Ote.
Col. Estrella
TORREON, COAH.
Tel: 171-18-21-99
P

MOROCCO

Etablissement Hubert Dolbeau & Fils
81 rue Karatchi
B.P. 11133
CASABLANCA
Tel: 3041-82, 3068-38
Telex: 23051, 22822
E

Gerep
2, rue Agadir
Boite Postale 156
CASABLANCA 01
Tel: 272093, 272095
Telex: 23 739
P

Sema-Maroc
Dept. Seric
6, rue Lapebie
CASABLANCA
Tel: 260980
Telex: 21641
C,P

NETHERLANDS

Hewlett-Packard Nederland B.V.
Startbaan 16
NL-1187 XR **AMSTELVEEN**
P.O. Box 667
NL-1180 AR **AMSTELVEEN**
Tel: (020) 547-6911
Telex: 13 216 HEPA NL
A,C,CM,E,M,P

Hewlett-Packard Nederland B.V.
Bongerd 2
NL 2906VK **CAPELLE A/D IJSSEL**
P.O. Box 41
NL 2900AA **CAPELLE A/D IJSSEL**
Tel: (10) 51-64-44
Telex: 21261 HEPAC NL
C,E

Hewlett-Packard Nederland B.V.
Pastoor Petersstraat 134-136
NL 5612 LV **EINDHOVEN**
P.O. Box 2342
NL 5600 CH **EINDHOVEN**
Tel: (040) 326911
Telex: 5 1484 hepae nl
C,E,P

NEW ZEALAND

Hewlett-Packard (N.Z.) Ltd.
5 Owens Road
P.O. Box 26-189
Epsom, **AUCKLAND**
Tel: 687-159
Cable: HEWPAK Auckland
C,CM,E,P*

Hewlett-Packard (N.Z.) Ltd.
184-190 Willis Street

WELLINGTON

P.O. Box 9443
Courtenay Place, **WELLINGTON 3**
Tel: 877-199
Cable: HEWPACK Wellington
C,CM,E,P

Northrop Instruments & Systems Ltd.
369 Khyber Pass Road
P.O. Box 8602

AUCKLAND

Tel: 794-091
Telex: 60605
A,M

Northrop Instruments & Systems Ltd.
110 Mandeville St.

P.O. Box 8388

CHRISTCHURCH

Tel: 488-873
Telex: 4203
A,M

Northrop Instruments & Systems Ltd.
Sturdee House

85-87 Ghuznee Street

P.O. Box 2406

WELLINGTON

Tel: 850-091
Telex: NZ 3380
A,M

NIGERIA

Elmeco Nigeria Ltd.
46, Calcutta Crescent Apapa
P.O. Box 244and

LAGOS

E

NORTHERN IRELAND

See United Kingdom

NORWAY

Hewlett-Packard Norge A/S
Folke Bernadottes vei 50
P.O. Box 3558
N-5033 **FYLLINGSDALEN** (Bergen)
Tel: 0047/5/16 55 40
Telex: 76621 hpnas n
C,E,M

Hewlett-Packard Norge A/S

Osterndalen 16-18

P.O. Box 34

N-1345 **OEËTERAAS**

Tel: 0047/2/24 60 90

Telex: 76621 hpnas n

A,C,CM,E,M,P

Hewlett-Packard Norge A/S
Boehmergt. 42
Box 2470
N-5037 **SOLHEIMSVIK**
Tel: 0047/5/29 00 90

OMAN

Khimjil Ramdas
P.O. Box 19
MUSCAT/SULTANATE OF OMAN
Tel: 795 901
Telex: 3489 BROKER MB MUSCAT
P

Suhail & Saud Bahwan
P.O.Box 169

MUSCAT/SULTANATE OF OMAN

Tel: 734 201-3
Telex: 5274 BAHWAN MB
E

Intac LLC

P.O. Box 9196

MINA AL FAHAL/SULTANATE OF OMAN

Tel: 561 695, 5602078, 561010
Telex: 5298 Tawoos On
A,C,M

PAKISTAN

Mushko & Company Ltd.
House No. 16, Street No. 16
Sector F-6/3

ISLAMABAD

Tel: 824545
Cable: FEMUS Isiamabad
A,E,P*

Mushko & Company Ltd.

Oosman Chambers

Abdullah Haroon Road

KARACHI 0302

Tel: 524131, 524132

Telex: 2894 MUSKO PK

Cable: COOPERATOR Karachi
A,E,P*

PANAMA

Electronico Balboa, S.A.
Calle Samuel Lewis, Ed. Alfa
Apartado 4929

PANAMA 5

Tel: 64-2700
Telex: 3483 ELECTRON PG
CM,E,M,P

PERU

Cía Electro Médica S.A.
Los Flamencos 145

San Isidro

Casilla 1030

LIMA 1

Tel: 41-4325, 41-3705

Telex: Pub. Booth 25306 PEC PISIDR

CM,E,M,P

SAMS S.A.

Avenida Republica de Panama 3534

San Isidro, **LIMA**

Tel: 419928/417108

Telex: 20450 PE LIBERTAD

A,C,P

PHILIPPINES

The Online Advanced Systems Corp.
2nd Floor, Electra House
115-117 Esteban Street
Legaspi Village, Makati
Metro **MANILA**
Tel: 815-38-10 (up to 16)
Telex: 63274 ONLINE PN
A,C,E,M,P

PORTUGAL

Mundinter Intercambio
Mundial de Comércio S.A.R.L.
Av. Antonio Augusto Aguiar 138
Apartado 2761
LISBON

Tel: (19) 53-21-31, 53-21-37

Telex: 16691 munter p

M

Soquimica

Av. da Liberdade, 220-2

1298 **LISBOA** Codex

Tel: 56-21-82

Telex: 13316 SABASA

A

Telectra-Empresa Técnica de
Equipamentos Eléctricos S.A.R.L.

Rua Rodrigo da Fonseca 103

P.O. Box 2531

LISBON 1

Tel: (19) 68-60-72

Telex: 12598

CM,E

C.P.C.S.I.

Rua de Costa Cabral 575

4200 **PORTO**

Tel: 499174/495173

Telex: 26054

C,P

PUERTO RICO

Hewlett-Packard Puerto Rico

101 Muñoz Rivera Av

Esu. Calle Ochoa

HATO REY, Puerto Rico 00918

Tel: (809) 754-7800

A,C,CM,M,E,P

QATAR

Computer Arabia

P.O. Box 2750

DOHA

Tel: 428555

Telex: 4806 CHPARB

P

Nasser Trading & Contracting

P.O.Box 1563

DOHA

Tel: 422170

Telex: 4439 NASSER DH

M

SAUDI ARABIA

Modern Electronics Establishment

Hewlett-Packard Division

P.O. Box 281

Thuobah

AL-KHOBAR 31952

Tel: 895-1760, 895-1764

Telex: 671 106 HPMEEK SJ

Cable: ELECTA AL-KHOBAR

C,E,M



SALES & SUPPORT OFFICES

Arranged alphabetically by country

SAUDI ARABIA (Cont'd)

Modern Electronics Establishment
Hewlett-Packard Division
P.O. Box 1228
Redec Plaza, 6th Floor
JEDDAH
Tel: 644 96 28
Telex: 4027 12 FARNAS SJ
Cable: ELECTA JEDDAH
A,C,CM,E,M,P

Modern Electronics Establishment
Hewlett-Packard Division
P.O.Box 22015
RIYADH 11495
Tel: 491-97 15, 491-63 87
Telex: 202049 MEERYD SJ
C,E,M

Abdul Ghani El Ajou Corp.
P.O. Box 78
RIYADH
Tel: 40 41 717
Telex: 200 932 EL AJOU
P

SCOTLAND

See United Kingdom

SENEGAL

Societe Hussein Ayad & Cie.
76, Avenue Georges Pompidou
B.P. 305

DAKAR
Tel: 32339
Cable: AYAD-Dakar
E
Moneger Distribution S.A.
1, Rue Parent
B.P. 148
DAKAR
Tel: 215 671
Telex: 587
P

Systeme Service Conseil (SSC)
14, Avenue du Parachois
DAKAR ETOILE
Tel: 219976
Telex: 577
C,P

SINGAPORE

Hewlett-Packard Singapore (Sales)
Pte. Ltd.
#08-00 Inchcape House
450-2 Alexandra Road
Alexandra P.O. Box 58
SINGAPORE, 9115
Tel: 473 1788
Telex: 34209 HPSGSO RS
Cable: HEWPACK, Singapore
A,C,E,M,P
Dynamar International Ltd.
Unit 05-11 Block 6
Kolam Ayer Industrial Estate
SINGAPORE 1334
Tel: 747-6188
Telex: 26283 RS
CM

SOUTH AFRICA

Hewlett-Packard So Africa (Pty.) Ltd.
P.O. Box 120
Howard Place **CAPE PROVINCE** 7430
Pine Park Center, Forest Drive
Pinelands
CAPE PROVINCE 7405
Tel: (021) 53 7954
Telex: 57-20006
A,C,CM,E,M,P

Hewlett-Packard So Africa (Pty.) Ltd.
2nd Floor Juniper House
92 Overport Drive
DURBAN 4067
Tel: (031) 28-4178
Telex: 6-22954
C

Hewlett-Packard So Africa (Pty.) Ltd.
6 Linton Arcade
511 Cape Road
Linton Grange
PORT ELIZABETH 6001
Tel: 041-301201
Telex: 24-2916
C

Hewlett-Packard So Africa (Pty.) Ltd.
Fountain Center
Kalkoen Str.
Monument Park Ext 2
PRETORIA 0105
Tel: (012) 45 5725
Telex: 32163
C,E

Hewlett-Packard So Africa (Pty.) Ltd.
9 Eastern Service Road
Eastgate Ext. 3
SANDTON 2144
Tel: 802-5111, 802-5125
Telex: 4-20877 SA
Cable: HEWPACK Johannesburg
A,C,CM,E,M,P

SPAIN

Hewlett-Packard Española, S.A.
Calle Entenza, 321
08029 **BARCELONA**
Tel: 3/322 24 51, 321 73 54
Telex: 52603 hpbee
A,C,E,M,P
Hewlett-Packard Española, S.A.
Calle San Vicente S/N
Edificio Albia II-7B
48001 **BILBAO**
Tel: 4/423 83 06
A,C,E,M

Hewlett-Packard Española, S.A.
Ctra. de la Coruña, Km. 16, 400
Las Rozas
E-MADRID
Tel: (1) 637.00.11
Telex: 23515 HPE
C,M

Hewlett-Packard Española, S.A.
Avda. S. Francisco Javier, S/N
Planta 10. Edificio Sevilla 2
41005 **SEVILLA**
Tel: 54/64 44 54
Telex: 72933
A,C,M,P

Hewlett-Packard Española, S.A.
Isabel La Católica, 8
46004 **VALENCIA**
Tel: (96) 351 59 44
Telex: 63435
C,P

Hewlett-Packard Española, S.A.
Av. de Zugazarte, 8
Edificio El Abra 4
Las Arenas-Guecho
VIZCAYA
Tel: (94) 464 3255, 464 2933
Telex: 33032

SWEDEN

Hewlett-Packard Sverige AB
Östra Tullgatan 3
S-20011 **MALMÖ**
Box 6132
Tel: (040) 70270
Telex: (854) 17886 (via Spånga office)
C,P
Hewlett-Packard Sverige AB
Västra Vintergatan 9
S-70344 **ÖREBRO**
Tel: (19) 10-48-80
Telex: (854) 17886 (via Spånga office)
C

Hewlett-Packard Sverige AB
Skalholtsgatan 9, Kista
Box 19
S-16393 **SPÅNGA**
Tel: (08) 750-2000
Telex: (854) 17886
Telefax: (08) 7527781
A,C,CM,E,M,P
Hewlett-Packard Sverige AB
Box 266
Topasgatan 1A
S-42123 **VÄSTRA-FRÖLUNDA**
(Gothenburg)
Tel: (031) 89-10-00
Telex: (854) 17886 (via Spånga office)
A,C,CM,E,M,P

SUDAN

Mediterranean Engineering & Trading
Co. Ltd.
P.O. Box 1025
KHARTOUM
Tel: 41184
Telex: 24052
C,P

SWITZERLAND

Hewlett-Packard (Schweiz) AG
Clarastrasse 12
CH-4058 **BASEL**
Tel: (61) 33-59-20
A,C,E,P
Hewlett-Packard (Schweiz) AG
7, rue du Bois-du-Lan
Case postale 365
CH-1217 **MEYRIN** 1
Tel: (0041) 22-83-11-11
Telex: 27333 HPAG CH
A,C,CM,E,M,P

Hewlett-Packard (Schweiz) AG
Allmend 2
CH-8967 **WIDEN**
Tel: (0041) 57 31 21 11
Telex: 53933 hpag ch
Cable: HPAG CH
A,C,CM,E,M,P

Hewlett-Packard (Schweiz) AG
Schwamendingenstrasse 10
8050 **ZÜRICH**
Tel: (0041) 1 315 81 81
Telex: 823 537 HPAG CH
C,P

SYRIA

General Electronic Inc.
Nuri Basha Ahnaf Ebn Kays Street
P.O. Box 5781
DAMASCUS
Tel: 33-24-87
Telex: 411 215
Cable: ELECTROBOR DAMASCUS
E

Middle East Electronics
P.O.Box 2308
Abu Rumaneh
DAMASCUS
Tel: 33 45 92
Telex: 411 771
M

TAIWAN

Hewlett-Packard Taiwan Ltd.
THM Office
2, Huan Nan Road
CHUNG LI, Taoyuan
Tel: (034) 929-666
C
Hewlett-Packard Taiwan Ltd.
Kaohsiung Office
11/F, 456, Chung Hsiao 1st Road
KAOHSIUNG
Tel: (07) 2412318
C,E
Hewlett-Packard Taiwan Ltd.
8th Floor, Hewlett-Packard Building
337 Fu Hsing North Road
TAIPEI
Tel: (02) 7 12-0404
Telex: 24439 HEWPACK
Cable: HEWPACK Taipei
A,C,CM,E,M,P
Ing Lih Trading Co.
6th Floor, 112, Sec. 1,
Chung Hsiao East Road
TAIPEI 100
Tel: (02) 394-8191
Telex: 22894 SANKWANG
A

THAILAND

Unimesa Co. Ltd.
30 Patpong Ave., Suriwong
BANGKOK 10500
Tel: 235-5727, 234-0991/3
Telex: 84439 Simonco TH
Cable: UNIMESA Bangkok
A,C,E,M

Bangkok Business Equipment Ltd.
5/5-6 Dejo Road

BANGKOK

Tel: 234-8670, 234-8671
Telex: 87699-BEQUIPT TH
Cable: BUSIQUIPT Bangkok
P

TOGO

Societe Africaine De Promotion
B.P. 12271

LOME

Tel: 21-62-88
Telex: 5304
P

TRINIDAD & TOBAGO

Caribbean Telecoms Ltd.
Corner McAllister Street &
Eastern Main Road, Laventille
P.O. Box 732

PORT-OF-SPAIN

Tel: 624-4213
Telex: 22561 CARTEL WG
Cable: CARTEL, PORT OF SPAIN
C,M,E,M,P

Computer and Controls Ltd.
P.O. Box 51

66 Independence Square

PORT-OF-SPAIN

Tel: 623-4472
Telex: 3000 POSTLX WG, ACCT
LOGO AGENCY 1264

A,P

Feral Assoc.
8 Fitzgerald Lane

PORT-OF-SPAIN

Tel: 62-36864, 62-39255
Telex: 22432 FERALCO
Cable: FERALCO

M

TUNISIA

Tunisie Electronique S.A.R.L.
31 Avenue de la Liberte

TUNIS

Tel: 280-144
C,E,P

Tunisie Electronique S.A.R.L.
94, Av. Jugurtha, Mutuelleville
1002 **TUNIS-BELVEDERE**

Tel: 280144
Telex: 13238

C,E,P

Corema S.A.
1 ter. Av. de Carthage

TUNIS

Tel: 253-821
Telex: 12319 CABAM TN

M

TURKEY

E.M.A
Mediha Eldem Sokak No. 41/6
Yenisehir

ANKARA

Tel: 319175
Telex: 42321 KTX TR
Cable: EMATRADE ANKARA

M

Teknim Company Ltd.

Iran Caddesi No. 7

Karaklidere

ANKARA

Tel: 275800
Telex: 42155 TKNM TR
C,E

Kurt & Kurt A.S.
Mithatpasa Caddesi No. 75
Kat 4 Kizilay

ANKARA

Tel: 318875/6/7/8
Telex: 42490 MESR TR
A

Saniva Bilgisayar Sistemleri A.S.
Buyukdere Caddesi 103/6

Gayrettepe

ISTANBUL

Tel: 1673180
Telex: 26345 SANI TR
C,P

Best Inc.

Esentepe, Gazeteciler Sitesi
Kesklin Kalem

Sokak 6/3, Gayrettepe

ISTANBUL

Tel: 172 1328, 173 3344
Telex: 42490
A

**UNITED ARAB
EMIRATES**

Emitac Ltd.
P.O. Box 1641

SHARJAH

Tel: 591181
Telex: 68136 EMITAC EM
Cable: EMITAC SHARJAH
E,C,M,P,A

Emitac Ltd.
P.O. Box 2711

ABU DHABI

Tel: 820419-20
Cable: EMITACH ABUDHABI

Emitac Ltd.
P.O. Box 8391

DUBAI,

Tel: 377591

Emitac Ltd.

P.O. Box 473

RAS AL KHAIMAH

Tel: 28133, 21270

UNITED KINGDOM

ENGLAND

Hewlett-Packard Ltd.

Miller House
The Ring, **BRACKNELL**

Berks RG12 1XN

Tel: 0344 424898

Telex: 848733

E

Hewlett-Packard Ltd.

Elstree House, Elstree Way
BOREHAMWOOD, Herts WD6 1SG

Tel: 01 207 5000

Telex: 8952716

C,E

Hewlett-Packard Ltd.

Oakfield House, Oakfield Grove

Clifton **BRISTOL**, Avon BS8 2BN

Tel: 0272 736806

Telex: 444302

C,E,P

Hewlett-Packard Ltd.

9 Bridewell Place

LONDON EC4V 6BS

Tel: 01 583 6565

Telex: 298163

C,P

Hewlett-Packard Ltd.

Pontefract Road

NORMANTON, West Yorkshire WF6 1RN

Tel: 0924 895566

Telex: 557355

C,P

Hewlett-Packard Ltd.

The Quadrangle

106-118 Station Road

REDHILL, Surrey RH1 1PS

Tel: 0737 68655

Telex: 947234

C,E,P

Hewlett-Packard Ltd.

Avon House

435 Stratford Road

Shirley, **SOLIHULL**, West Midlands

B90 4BL

Tel: 021 745 8800

Telex: 339105

C,E,P

Hewlett-Packard Ltd.

Heathside Park Road

Cheadle Heath

STOCKPORT

Cheshire

SK3 ORB

Tel: 061-428-0828

Telex: 668068

A,C,E,M,P

Hewlett-Packard Ltd.

Harmon House

No. 1 George Street

UXBRIDGE, Middlesex UX8 1YN

Tel: 895 720 20

Telex: 893134/5

C,CM,E,M,P

Hewlett-Packard Ltd.

King Street Lane

Winnersh, **WOKINGHAM**

Berkshire RG11 5AR

Tel: 0734 784774

Telex: 847178

A,C,E,M,P

NORTHERN IRELAND

Hewlett-Packard (Ireland) Ltd.

Carrickfergus Industrial Centre

75 Belfast Road, Carrickfergus

CO. ANTRIM BT38 8PM

Tel: 09603 67333

C,E

Cardiac Services Company

95A Finaghy Road South

BELFAST, BT10 OBY

Tel: 0232-625566

Telex: 747626

M

SCOTLAND

Hewlett-Packard Ltd.

1/3 Springburn Place

College Milton North

EAST KILBRIDE, G74 3NU

Tel: 03552-49261

Telex: 779615

C,E

Hewlett-Packard Ltd.

SOUTH QUEENSFERRY

West Lothian, EH30 9TG

Tel: 031 331 1188

Telex: 72682

C,CM,E,M,P

UNITED STATES

Alabama

Hewlett-Packard Co.

2100 Riverchase Center

Building 100 - Suite 118

BIRMINGHAM, AL 35244

Tel: (205) 988-0547

A,C,M,P*

Hewlett-Packard Co.

420 Wynn Drive

HUNTSVILLE, AL 35805

Tel: (205) 830-2000

C,CM,E,M*

Alaska

Hewlett-Packard Co.

3601 C St., Suite 1416

ANCHORAGE, AK 99503

Tel: (907) 563-8855

C,E

Arizona

Hewlett-Packard Co.

8080 Pointe Parkway West

PHOENIX, AZ 85044

Tel: (602) 273-8000

A,C,CM,E,M,P

Hewlett-Packard Co.

3400 East Britannia Dr.

Bldg. C, Suite 124

TUCSON, AZ 85706

Tel: (602) 573-7400

C,E,M**

California

Hewlett-Packard Co.

99 South Hill Dr.

BRISSANE, CA 94005

Tel: (415) 330-2500

C

Hewlett-Packard Co.

5060 E. Clinton Avenue, Suite 102

FRESNO, CA 93727

Tel: (209) 252-9652

C,M

Hewlett-Packard Co.

1421 S. Manhattan Av.

FULLERTON, CA 92631

Tel: (714) 999-8700

C,CM,E,M

Hewlett-Packard Co.

7408 Hollister Ave. #A

GOLETA, CA 93117

Tel: (805) 685-6100

C,E



SALES & SUPPORT OFFICES

Arranged alphabetically by country

UNITED STATES (Cont'd)

Hewlett-Packard Co.
2525 Grand Avenue
LONG BEACH, CA 90815
Tel: (213) 498-1111
C

Hewlett-Packard Co.
5651 West Manchester Ave.
LOS ANGELES, CA 90045
Tel: (213) 337-8000
Telex: 910-325-6608
C,M

Hewlett-Packard Co.
3155 Porter Drive
PALO ALTO, CA 94304
Tel: (415) 857-8000
C,E

Hewlett-Packard Co.
4244 So. Market Court, Suite A
SACRAMENTO, CA 95834
Tel: (916) 929-7222
A*,C,E,M

Hewlett-Packard Co.
9606 Aero Drive
SAN DIEGO, CA 92123
Tel: (619) 279-3200
C,CM,E,M

Hewlett-Packard Co.
5725 W. Las Positas Blvd.
PLEASANTON, CA 94566
Tel: (415) 460-0282
C

Hewlett-Packard Co.
3003 Scott Boulevard
SANTA CLARA, CA 95054
Tel: (408) 988-7000
Telex: 910-338-0586
A,C,CM,E

Hewlett-Packard Co.
2150 W. Hillcrest Dr.
THOUSAND OAKS, CA 91320
(805) 373-7000
C,CM,E

Colorado
Hewlett-Packard Co.
2945 Center Green Court South
Suite A
BOULDER, CO 80301
Tel: (303) 499-6655
A,C,E

Hewlett-Packard Co.
24 Inverness Place, East
ENGLEWOOD, CO 80112
Tel: (303) 649-5000
A,C,CM,E,M

Connecticut
Hewlett-Packard Co.
500 Sylvan Av.
BRIDGEPORT, CT 06606
Tel: (203) 371-6454
C,E

Hewlett-Packard Co.
47 Barnes Industrial Road South
WALLINGFORD, CT 06492
Tel: (203) 265-7801
A,C,CM,E,M

Florida

Hewlett-Packard Co.
2901 N.W. 62nd Street
FORT LAUDERDALE, FL 33309
Tel: (305) 973-2600
C,E,M,P*

Hewlett-Packard Co.
6800 South Point Parkway
Suite 301
JACKSONVILLE, FL 32216
Tel: (904) 636-9955
C*,M**

Hewlett-Packard Co.
255 East Drive, Suite B
MELBOURNE, FL 32901
Tel: (305) 729-0704
CM,E

Hewlett-Packard Co.
6177 Lake Ellenor Drive
ORLANDO, FL 32809
Tel: (305) 859-2900
A,C,CM,E,P*

Hewlett-Packard Co.
4700 Bayou Blvd.
Building 5
PENSACOLA, FL 32503
Tel: (904) 476-8422
A,C,M

Hewlett-Packard Co.
5550 W. Idlewild, #150
TAMPA, FL 33614
Tel: (813) 884-3282
C,E,M,P

Georgia
Hewlett-Packard Co.
2000 South Park Place
ATLANTA, GA 30339
Tel: (404) 955-1500
Telex: 810-766-4890
A,C,CM,E,M,P*

Hewlett-Packard Co.
3607 Parkway Lane
Suite 300
NORCROSS, GA 30092
Tel: (404) 448-1894
C,E,P

Hawaii
Hewlett-Packard Co.
Kawalahao Plaza, Suite 190
567 South King Street
HONOLULU, HI 96813
Tel: (808) 526-1555
A,C,E,M

Idaho
Hewlett-Packard Co.
11309 Chinden Blvd.
BOISE, ID 83707
Tel: (208) 323-2700
C

Illinois
Hewlett-Packard Co.
304 Eldorado Road
P.O. Box 1607
BLOOMINGTON, IL 61701
Tel: (309) 662-9411
A,C,E,M**

Hewlett-Packard Co.
525 W. Monroe, #1308
CHICAGO, IL 60606
Tel: (312) 930-0010
C

Hewlett-Packard Co.
1200 East Diehl Road
NAPERVILLE, IL 60566
Tel: (312) 357-8800
C

Hewlett-Packard Co.
5201 Tollview Drive
ROLLING MEADOWS, IL 60008
Tel: (312) 255-9800
Telex: 910-687-1066
A,C,CM,E,M

Indiana

Hewlett-Packard Co.
11911 N. Meridian St.
CARMEL, IN 46032
Tel: (317) 844-4100
A,C,CM,E,M

Hewlett-Packard Co.
111 E. Ludwig Road
Suite 108
FT. WAYNE, IN 46825
Tel: (219) 482-4283
C,E

Iowa

Hewlett-Packard Co.
4070 22nd Av. SW
CEDAR RAPIDS, IA 52404
Tel: (319) 390-4250
C,E,M

Hewlett-Packard Co.
4201 Corporate Dr.
WEST DES MOINES, IA 50265
Tel: (515) 224-1435
A**,C,M**

Kansas

Hewlett-Packard Co.
7804 East Funston Road, Suite 203
WICHITA, KS 67207
Tel: (316) 684-8491
C,E

Kentucky

Hewlett-Packard Co.
10300 Linn Station Road, Suite 100
LOUISVILLE, KY 40223
Tel: (502) 426-0100
A,C,M

Louisiana

Hewlett-Packard Co.
160 James Drive East
ST. ROSE, LA 70087
P.O. Box 1449
KENNER, LA 70063
Tel: (504) 467-4100
A,C,E,M,P

Maryland

Hewlett-Packard Co.
3701 Koppers Street
BALTIMORE, MD 21227
Tel: (301) 644-5800
Telex: 710-862-1943
A,C,CM,E,M

Hewlett-Packard Co.
2 Choke Cherry Road
ROCKVILLE, MD 20850
Tel: (301) 948-6370
A,C,CM,E,M

Massachusetts

Hewlett-Packard Co.
1775 Minuteman Road
ANDOVER, MA 01810
Tel: (617) 682-1500
A,C,CM,E,M,P*

Hewlett-Packard Co.
32 Hartwell Avenue
LExINGTON, MA 02173
Tel: (617) 861-8960
C,E

Michigan

Hewlett-Packard Co.
4326 Cascade Road S.E.
GRAND RAPIDS, MI 49506
Tel: (616) 957-1970
C,M

Hewlett-Packard Co.
39550 Orchard Hill Place Drive
NOVI, MI 48050
Tel: (313) 349-9200
A,C,E,M

Hewlett-Packard Co.
1771 W. Big Beaver Road
TROY, MI 48084
Tel: (313) 643-6474
C

Minnesota

Hewlett-Packard Co.
2025 W. Larpentaur Ave.
ST. PAUL, MN 55113
Tel: (612) 644-1100
A,C,CM,E,M

Missouri

Hewlett-Packard Co.
1001 E. 101st Terrace Suite 120
KANSAS CITY, MO 64131-3368
Tel: (816) 941-0411
A,C,CM,E,M

Hewlett-Packard Co.
13001 Hollenberg Drive
BRIDGETON, MO 63044
Tel: (314) 344-5100
A,C,E,M

Nebraska

Hewlett-Packard
11626 Nicholas St.
OMAHA, NE 68154
Tel: (402) 493-0300
C,E,M

New Jersey

Hewlett-Packard Co.
120 W. Century Road
PARAMUS, NJ 07653
Tel: (201) 265-5000
A,C,CM,E,M

Hewlett-Packard Co.
20 New England Av. West
PISCATAWAY, NJ 08854
Tel: (201) 562-6100
A,C,CM,E

New Mexico

Hewlett-Packard Co.
7801 Jefferson N.E.
ALBUQUERQUE, NM 87109
Tel: (505) 823-6100
C,E,M

Hewlett-Packard Co.
1460 Trinity Dr., Suite 3
LOS ALAMOS, NM 87544
Tel: (505) 662-6700
C,E

New York

Hewlett-Packard Co.
5 Computer Drive South
ALBANY, NY 12205
Tel: (518) 458-1550
A,C,E,M

Hewlett-Packard Co.
9600 Main Street
CLARENCE, NY 14031
Tel: (716) 759-8621
C,E

Hewlett-Packard Co.
200 Cross Keys Office Park
FAIRPORT, NY 14450
Tel: (716) 223-9950
A,C,CM,E,M

Hewlett-Packard Co.
7641 Henry Clay Blvd.
LIVERPOOL, NY 13088
Tel: (315) 451-1820
A,C,CM,E,M

Hewlett-Packard Co.
No. 1 Pennsylvania Plaza
55th Floor
34th Street & 8th Avenue
MANNHATTAN NY 10119
Tel: (212) 971-0800
C,M*

Hewlett-Packard Co.
15 Myers Corner Rd.
Hollowbrook Park, Suite 2D
WAPPINGER FALLS, NY 12590
Tel: (914) 298-9125
CM,E

Hewlett-Packard Co.
2975 Westchester Avenue
PURCHASE, NY 10577-2590
Tel: (914) 935-6300
C,CM,E

Hewlett-Packard Co.
3 Crossways Park West
WOODBURY, NY 11797
Tel: (516) 682-7800
A,C,CM,E,M

North Carolina

Hewlett-Packard Co.
305 Gregson Dr.
CARY, NC 27511
Tel: (919) 467-6600
C,CM,E,M,P*

Hewlett-Packard Co.
9600-H Southern Pine Blvd.
CHARLOTTE, NC 28210
Tel: (704) 527-8780
C*

Hewlett-Packard Co.
5605 Roanne Way
GREENSBORO, NC 27420
Tel: (919) 852-1800
A,C,CM,E,M,P*

Ohio

Hewlett-Packard Co.
2717 S. Arlington Road
AKRON, OH 44312
Tel: (216) 644-2270
C,E

Hewlett-Packard Co.
4501 Erskine Road
CINCINNATI, OH 45242
Tel: (513) 891-9870
C,M

Hewlett-Packard Co.
15885 Sprague Road
CLEVELAND, OH 44136
Tel: (216) 243-7300
A,C,CM,E,M

Hewlett-Packard Co.
9080 Springboro Pike
MIAMISBURG, OH 45342
Tel: (513) 433-2223
A,C,CM,E*,M

Hewlett-Packard Co.
One Maritime Plaza, 5th Floor
720 Water Street
TOLEDO, OH 43604
Tel: (419) 242-2200
C

Hewlett-Packard Co.
675 Brookside Blvd.
WESTERVILLE, OH 43081
Tel: (614) 891-3344
C,CM,E*

Oklahoma

Hewlett-Packard Co.
3525 N.W. 56th St.
Suite C-100
OKLAHOMA CITY, OK 73112
Tel: (405) 946-9499
C,E*,M

Hewlett-Packard Co.
3840 S. 103rd E. Ave., #100
TULSA, OK 74146
Tel: (918) 665-3300
A**,C,E,M*,P*

Oregon

Hewlett-Packard Co.
9255 S. W. Pioneer Court
WILSONVILLE, OR 97070
Tel: (503) 682-8000
A,C,E*,M

Pennsylvania

Hewlett-Packard Co.
50 Dorchester Rd.
HARRISBURG, PA 17112
Tel: (717) 657-5900
C

Hewlett-Packard Co.
111 Zeta Drive
PITTSBURGH, PA 15238
Tel: (412) 782-0400
A,C,E,M

Hewlett-Packard Co.
2750 Monroe Boulevard
VALLEY FORGE, PA 19482
Tel: (215) 666-9000
A,C,CM,E,M

South Carolina

Hewlett-Packard Co.
Brookside Park, Suite 122
1 Harbison Way
COLUMBIA, SC 29210
Tel: (803) 732-0400
C,M

Hewlett-Packard Co.
545 N. Pleasantburg Dr.
Suite 100
GREENVILLE, SC 29607
Tel: (803) 232-8002
C

Tennessee

Hewlett-Packard Co.
One Energy Centr. Suite 200
Pellissippi Pkwy.
KNOXVILLE, TN 37932
Tel: (615) 966-4747
A,C,M

Hewlett-Packard Co.
3070 Directors Row
Directors Square
MEMPHIS, TN 38131
Tel: (901) 346-8370
A,C,M

Hewlett-Packard Co.
220 Great Circle Road, Suite 116
NASHVILLE, TN 37228
Tel: (615) 255-1271
A,C,E,M,P

Texas

Hewlett-Packard Co.
1826-P Kramer Lane
AUSTIN, TX 78758
Tel: (512) 835-6771
C,E,P*

Hewlett-Packard Co.
5700 Cromo Dr
EL PASO, TX 79912
Tel: (915) 833-4400
C,E*,M**

Hewlett-Packard Co.
3952 Sandshell Drive
FORT WORTH, TX 76137
Tel: (817) 232-9500
C

Hewlett-Packard Co.
10535 Harwin Drive
HOUSTON, TX 77036
Tel: (713) 776-6400
A,C,E,M,P*

Hewlett-Packard Co.
3301 Royal Lane
IRVING, TX 75063
Tel: (214) 869-3377
C,E

Hewlett-Packard Co.
109 E. Toronto, Suite 100
McALLEN, TX 78503
Tel: (512) 630-3030
C

Hewlett-Packard Co.
930 E. Campbell Rd.
RICHARDSON, TX 75081
Tel: (214) 231-6101
A,C,CM,E,M,P*

Hewlett-Packard Co.
1020 Central Parkway South
SAN ANTONIO, TX 78232
Tel: (512) 494-9336
A,C,E,M,P*

Utah

Hewlett-Packard Co.
3530 W. 2100 South St.
SALT LAKE CITY, UT 84119
Tel: (801) 974-1700
A,C,E,M

Virginia

Hewlett-Packard Co.
840 Greenbrier Circle
Suite 101
CHESAPEAKE, VA 23320
Tel: (804) 424-7105
C,E,M

Hewlett-Packard Co.
4305 Cox Road
GLEN ALLEN, VA 23060
Tel: (804) 747-7750
A,C,E,M,P*

Hewlett-Packard Co.
Tanglewood West Bldg.
Suite 240
3959 Electric Road
ROANOKE, VA 24018
Tel: (703) 774-3444
C,E,P

Washington

Hewlett-Packard Co.
15815 S.E. 37th Street
BELLEVUE, WA 98006
Tel: (206) 643-4000
A,C,CM,E,M

Hewlett-Packard Co.
North 708 Argonne Road
SPOKANE, WA 99212-2793
Tel: (509) 922-7000
C

West Virginia

Hewlett-Packard Co.
501 56th Street
CHARLESTON, WV 25304
Tel: (304) 925-0492
A,C,M

Wisconsin

Hewlett-Packard Co.
275 N. Corporate Dr.
BROOKFIELD, WI 53005
Tel: (414) 794-8800
A,C,E*,M

URUGUAY

Pablo Ferrando S.A.C. e I.
Avenida Italia 2877
Casilla de Correo 370
MONTEVIDEO
Tel: 80-3805
Telex: Public Booth 901
A,CM,E,M



SALES & SUPPORT OFFICES

Arranged alphabetically by country

URUGUAY (Cont'd)

Olympia de Uruguay S.A.
Maquinas de Oficina
Avda. del Libertador 1997
Casilla de Correos 6644
MONTEVIDEO

Tel: 91-1809, 98-3807
Telex: 6342 OROU UY
P

VENEZUELA

Hewlett-Packard de Venezuela C.A.
3A Transversal Los Ruices Norte
Edificio Segre 2 & 3
Apartado 50933
CARACAS 1050

Tel: (582) 239-4133
Telex: 251046 HEWPACK
A,C,CM,E,M,P

Hewlett-Packard de Venezuela, C.A.
Centro Ciudad Comercial Tamanaco
Nivel C-2 (Nueva Etapa)
Local 53H05
Chua, **CARACAS**

Tel: 928291
P

Albis Venezolana S.R.L.
Av. Las Marias, Ota. Alix,
El Pedregal
Apartado 81025
CARACAS 1080A
Tel: 747984, 742146
Telex: 24009 ALBIS VC
A

Tecnologica Medica del Caribe, C.A.
Multicentro Empresarial del Este
Ave. Libertador
Edif. Libertador
Nucleo "C" - Oficina 51-52
CARACAS

Tel: 339867/333780
M

Hewlett-Packard de Venezuela C.A.
Residencias Tia Betty Local 1
Avenida 3 y con Calle 75
MARACAIBO, Estado Zulia
Apartado 2646

Tel: (5861) 80304
Telex: 62464 HPMAR
C,E*

Hewlett-Packard de Venezuela C.A.
Urb. Lomas de Este
Torre Trebol — Piso 11
VALENCIA, Estado Carabobo
Apartado 3347

Tel: (5841) 222992
C,P

YUGOSLAVIA

Do Hermes
General Zdanova 4
YU-11000 **BEOGRAD**
Tel: (011) 342 641
Telex: 11433
A,C,E,M,P

Do Hermes
Celovska 73
YU-61000 **LJUBLJANA**
Tel: (061) 553 170
Telex: 31583
A,C,E,M,P

Elektrotehna
Titova 51
YU-61000 **LJUBLJANA**
CM

Do Hermes
Kralja Tomislava 1
YU-71000 **SARAJEVO**
Tel: (071) 35 859
Telex: 41634
C**,P

ZAIRE

Computer & Industrial Engineering
25, Avenue de la Justice
B.P. 12797

KINSHASA, Gombe
Tel: 32063
Telex: 21552
C,P

ZAMBIA

R.J. Tilbury (Zambia) Ltd.
P.O. Box 32792

LUSAKA
Tel: 215590
Telex: 40128
E

ZIMBABWE

Field Technical Sales (Private) Limited
45, Kelvin Road North
P.O. Box 3458
SALISBURY
Tel: 705 231
Telex: 4-122 RH
E,P

August 1986