

Agilent PN 89400-14A

10

Steps
to a
Perfect
Digital
Demodulation
Measurement

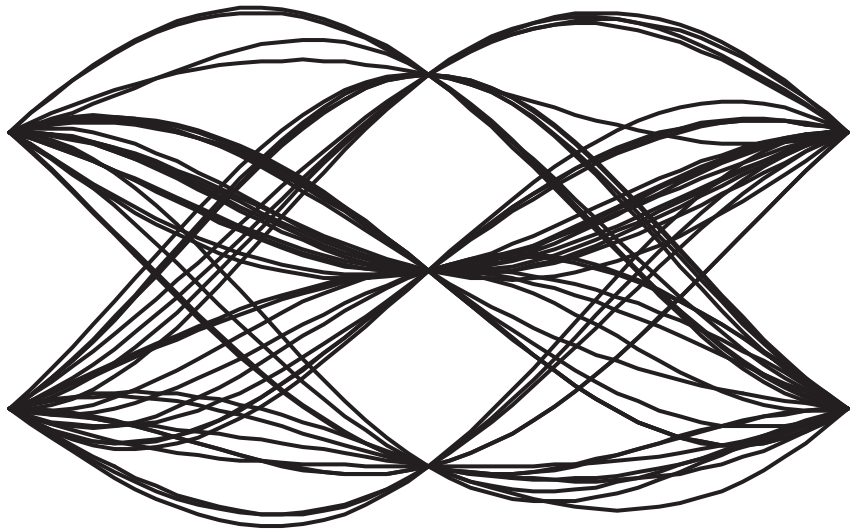

Agilent Technologies

Innovating the HP Way

The following general procedure is recommended as guidance for configuring the 89400 to demodulate and characterize a wide variety of digitally modulated signals. Follow it step-by-step to insure that no important setup parameters are missed or incorrectly programmed.



STEP
1

Set the analyzer's center frequency and span for the signal under test (vector mode).

Hint: The center frequencies of the analyzer and input signal must match to within $\pm 3\%$ of the symbol rate ($\pm 1\%$ for 64QAM and $\pm 0.2\%$ for 256QAM).

Check: The signal's spectrum should occupy 50–90% of the span, and not extend beyond the edges. It should appear as a distinct, elevated region of noise 20 dB or more above the analyzer noise floor. Broad, glitching sidebands indicate bursts or other transients, which can be handled with triggering or the Pulse Search function. These procedures are described in steps 3 and 8.



STEP
2

Set the input range as low as possible without overload.

Hint: The green input LED may or may not be on; the yellow overrange LED must not be on.

Check: Downrange by 1 step; overload indicators should turn on.



STEP
3

Set up Triggering, if required.

Hint: Triggering is unnecessary for most signals (see notes below regarding use of the 89400's internal arbitrary waveform source). For TDMA and other bursted signals, use Pulse Search instead of triggering (activated in step 8, right). Otherwise, choose trigger mode, level, delay, holdoff, and arming just as you would with an oscilloscope, in accordance with the characteristics of your specific signal.

Hint: With the Trigger menu selected, a display of Main Time: Magnitude shows the current trigger level as a horizontal cursor, superimposed on the input waveform.

Check: With triggering in use, the time domain display should show a stable signal that occupies $>50\%$ of the time span.



STEP
4

Select Digital Demodulation mode.

Hint: Be aware that this mode retains the settings from its previous digital demodulation measurement. If, for example, the previous symbol rate setting is incompatible with your current frequency span, the analyzer may automatically increase or decrease your frequency span.

Check: Make certain that the frequency span is still the same as you set in step 1.



STEP
5

Enter the correct modulation format under Demodulation Setup.

Hint: This is simple unless you do not know the modulation format. Identifying an unknown signal format is a significant challenge requiring specialized expertise.



STEP
6

Enter the correct symbol rate.

Hint: The symbol rate needs to be entered to an accuracy of 10–100 ppm.

Hint: Identifying an unknown symbol rate is difficult, but it sometimes helps to AM demodulate the signal and look at the high end of the demod spectrum for a discrete signal at the symbol rate (it's easier to see with averaging). Also remember that the 3 dB bandwidth of the signal is approximately equal to the symbol rate. (Neither technique will yield the accuracy required, but the results may help you remember the actual numbers).



STEP
7

Select the result length and points/symbol for the desired display.

Hint: Result length is important for bursted signals, as you don't want to include data symbols taken before or after the burst (i.e. you don't want to demodulate noise).

Hint: More points/symbol reveal more detail of the intersymbol waveforms (for viewing eye diagrams, error peaks, etc.). Fewer points/symbol allow you to demodulate more symbols per measurement (remember: result length* points/symbol must always be less than max time points).



STEP
8

Turn on Pulse Search and set the Search Length (burst signals only).

Hint: Maximum search length can be many times longer than a time record; set it to the burst "off" time plus twice the burst "on" time to insure that there's always a complete burst in every search.

Hint: This is also a good time to set up the "Sync Search" function if needed. Check online Help for a good description of its capabilities.



STEP 9

Select the filter shapes and alpha.

Hint: To choose the right filters, remember: the “measured” filter should simulate the intended receiver, while the “reference” filter should match the product of the transmitter and receiver filters.

Hint: If the alpha is unknown, estimate it from $(60 \text{ dB BW}/3 \text{ dB BW}) - 1$. EVM peaks between symbols mean an incorrect alpha, but won’t usually affect the EVM% readout (except in GSM). In the worst case, start with 0.3 and manually adjust up or down for lowest intersymbol peaks.



STEP 10

Final Checks.

Look for the following:

- Overall shape of eye and/or constellation diagrams is regular and stable (even if individual symbols are very noisy, the characteristic shape should be evident). Eye opening should line up precisely with the display center line—if not, tweak “clock adjust” for best centering (lowest EVM).
- On the data table display, the EVM% readout is fairly consistent from measurement to measurement.
- EVM vs. symbol trace is noise-like, but fairly uniform (short peaks are OK). Abrupt changes within the EVM trace signify problems, as do sloping or V-shaped distributions. If problems exist, consult the analyzer’s on-line Help under “digital demodulation troubleshooting.”

Special procedures for using the 89400 arbitrary waveform source

Demodulating signals created by the Agilent 89400’s internal arbitrary waveform source involves constraints not found with “real-world” signals. This is due to the fact that the arbitrary signal is not continuous, but subject to discontinuities in amplitude, phase, and/or timing each time the waveform wraps around from end to beginning. Therefore, in addition to the above steps, always perform the following:

- Use trigger type = Internal Source.
- Set a positive trigger delay to avoid the first 5–10 symbols of the waveform.
- Choose a result length shorter than the arbitrary waveform duration (you can determine the length of the arbitrary waveform empirically by increasing result length until demod abruptly loses lock).

Using Error Vector Magnitude Measurements to Analyze and Troubleshoot Vector-Modulated Signals

Error vector magnitude (EVM) measurements can provide a great deal of insight into the performance of digitally modulated signals. With proper use, EVM and related measurements can pinpoint exactly the type of degradations present in a signal and can even help identify their sources. This note reviews the basics of EVM measurements on the Agilent 89400 vector signal analyzers, and outlines a general procedure that may be used to methodically track down even the most obscure signal problems.

The diverse technologies that comprise today's digital RF communications systems share in common one main goal: placing digital bitstreams onto RF carriers and then recovering them with accuracy, reliability, and efficiency. Achieving this goal demands engineering time and expertise, coupled with keen insights into RF system performance.

Vector signal analyzers such as the 89400 perform the time, frequency, and modulation domain analyses that provide these insights. Because they process signals in full vector (magnitude and phase) form, they easily accommodate the complex modulation formats used for digital RF communications. Perhaps most importantly, these analyzers contribute a relatively new type of measurement called "error vector magnitude" or EVM.

Primarily a measure of signal quality, EVM provides both a simple, quantitative figure-of-merit for a digitally modulated signal, along with a far-reaching methodology for uncovering and attacking the underlying causes of signal impairments and distortion. EVM measurements are growing rapidly in acceptance, having already been written into such important system standards as GSM¹, NADC², and PHS³, and they are poised to appear in several upcoming standards, including those for digital video transmission. This note defines error vector magnitude and related measurements, discusses how they are implemented, and explains how they are practically applied in digital RF communications design.

1. Global System for Mobile Communications
2. North American Digital Cellular
3. Personal Handyphone System

Understanding error vector magnitude

EVM defined

Recall first the basics of vector modulation: digital bits are transferred onto an RF carrier by varying the carrier's magnitude and phase such that, at each data clock transition, the carrier occupies any one of several specific locations on the I versus Q plane. Each location encodes a specific data symbol, which consists of one or more data bits. A constellation diagram shows the valid locations (for example, the magnitude and phase relative to the carrier) for all permitted symbols, of which there must be $2n$, given n data bits transmitted per symbol. Thus, to demodulate the incoming data, one must accurately determine the exact magnitude and phase of the received signal for each clock transition.

The layout of the constellation diagram and its ideal symbol locations is determined generically by the modulation format chosen (BPSK, 16QAM, $\pi/4$ DQPSK, etc.). The trajectory taken by the signal from one symbol location to another is a function of the specific system implementation, but is readily calculated nonetheless.

At any moment in time, the signal's magnitude and phase can be measured. These values define the actual or "measured" phasor. At the same time, a corresponding ideal or "reference" phasor can be calculated, given knowledge of the transmitted data stream, the symbol clock timing, baseband filtering parameters, and so forth. The differences between these two phasors form the basis for the EVM measurements discussed in this note.

Figure 1 defines EVM and several related terms. As shown, EVM is the scalar distance between the two phasor end points (the magnitude of the difference vector). Expressed another way, it is the residual noise and distortion remaining after an ideal version of the signal has been stripped away. By convention, EVM is reported as a percentage of the peak signal level, usually defined by the constellation's corner states. While the error vector has a phase value associated with it, this angle generally turns out to be random, because it is a function of both the error itself (which may or may not be random) and the position of the data symbol on the constellation (which, for all practical purposes, is random). A more useful angle is measured between the actual and ideal phasors (I-Q phase error), which will be shown later to contain information useful in troubleshooting signal problems. Likewise, I-Q magnitude error shows the magnitude difference between the actual and ideal signals.

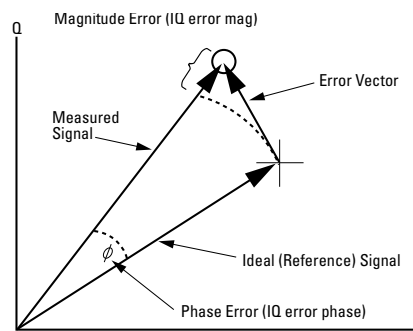

Figure 1. Error vector magnitude (EVM) and related quantities

Making EVM measurements

The sequence of steps that comprise an EVM measurement are illustrated in Figure 2. While the Agilent 89400 Vector Signal Analyzers perform these steps automatically, it is still useful to understand the basic process, which will aid in setting up and optimizing the measurements.

Step 1. Precision demodulation

Following analog-to-digital conversion of the incoming signal, a DSP¹ based demodulator recovers the transmitted bitstream. This task includes everything from carrier and data symbol clock locking to baseband filtering. The 89400's flexible demodulator can demodulate signal formats ranging from BPSK to 256QAM, at symbol rates from hundreds to several megahertz, yet can be configured for the most common signal types with a single menu selection.

Step 2. Regenerating the reference waveform

The recovered data bits are next used to create the ideal reference version of the input signal. This is again accomplished digitally with powerful DSP calculating a waveform that is both completely noise-free and highly accurate.

Step 3. Complex comparison

Taking the calculated reference waveform and the actual incoming waveform (both now existing as blocks of digital samples), the two need only be subtracted to obtain the error vector values. This is only slightly complicated by the fact that both waveforms are complex, consisting of *I* and *Q* waveforms. Fortunately, the 89400's DSP engine has sufficient power to handle this vector subtraction and provide the desired measurement data.

A final note

The analyzer's ADC samples the incoming signal asynchronously, so it will generally not provide actual measured data points at the exact symbol times. However, a special resampling algorithm, applied to the incoming ADC samples, creates an entirely new, accurate set of "virtual samples," whose rate and timing are precisely in sync with the received symbols. (This is easily seen on the 89400 by observing the time-sample spacings of an input waveform, first in standard vector mode, and then in digital demodulation mode).

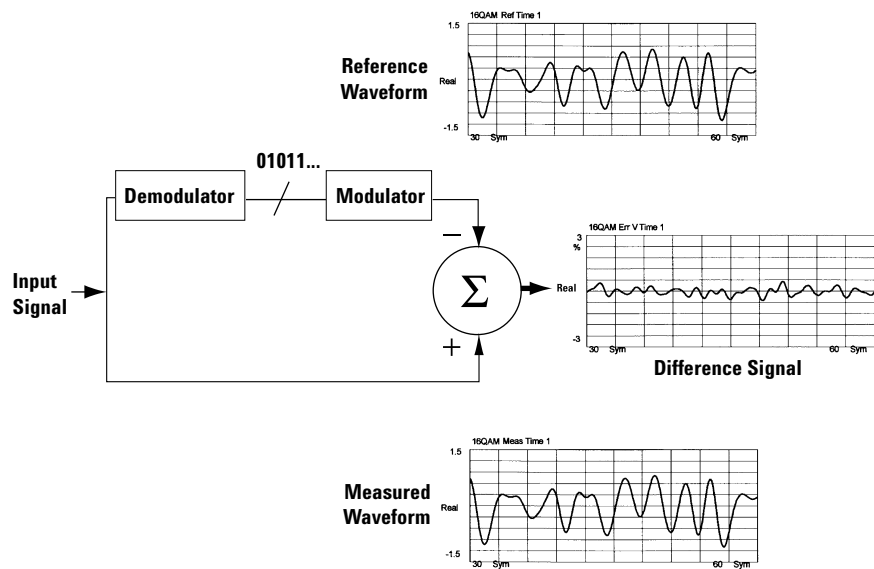

Figure 2. Block diagram of the EVM measurement process

1. Digital Signal Processing

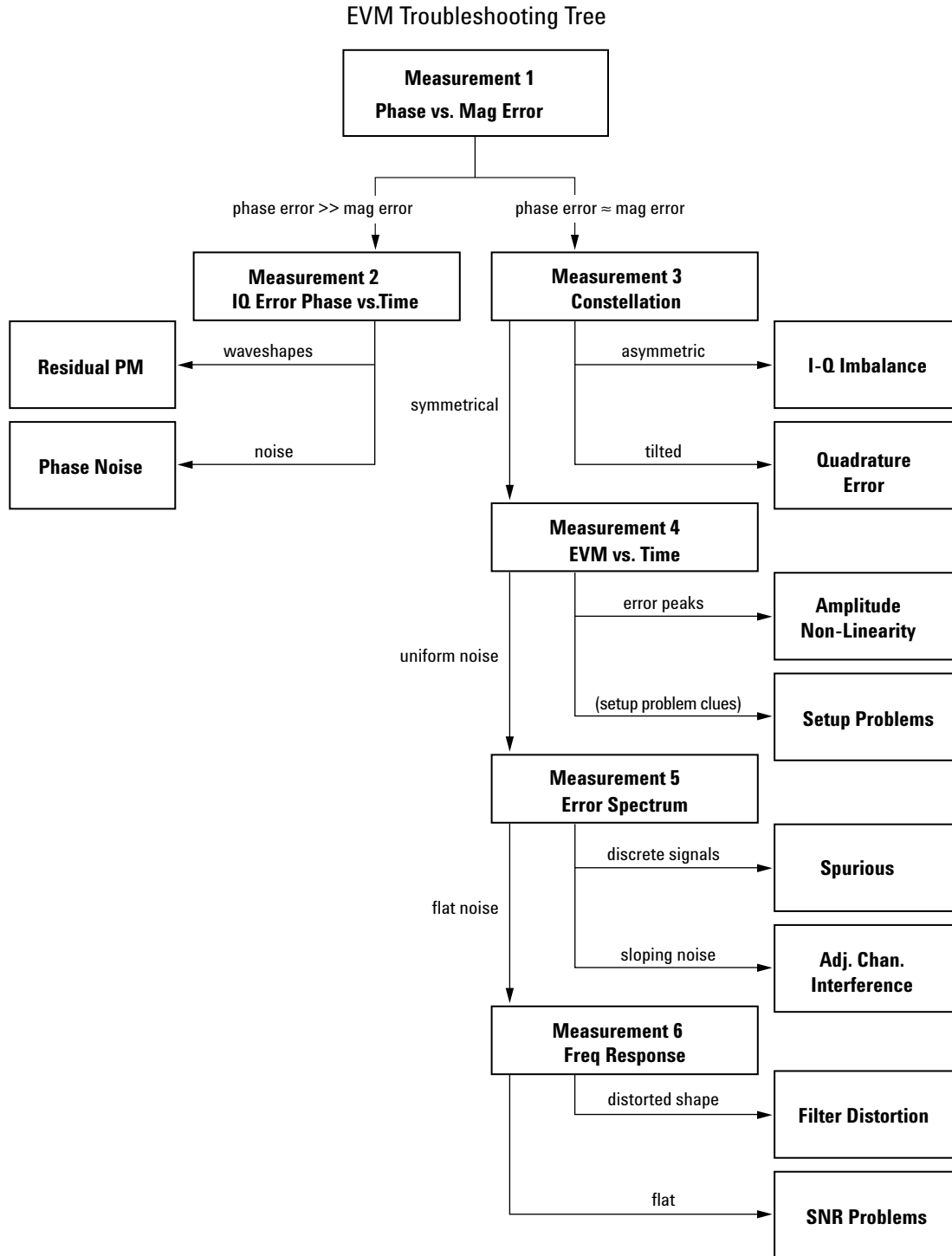

Figure 3. Flow chart for analyzing vector modulated signals with EVM measurements

Troubleshooting with error vector measurements

Measurements of error vector magnitude and related quantities can, when properly applied, provide insight into the quality of a digitally modulated signal. They can also pin-point the causes of any problems uncovered during the testing process. This section proposes a general sequence for examining a signal with EVM techniques, and for interpreting the results obtained.

Note: The following sections are not intended as step-by-step procedures, but rather as general guidelines for those who are already familiar with basic operation of the 89400. For additional information, consult the instrument's on-screen Help facility or the references in the bibliography.

Measurement 1

Magnitude vs. phase error

Description: Different error mechanisms will affect a signal in different ways, perhaps in magnitude only, phase only, or both simultaneously. Knowing the relative amounts of each type of error can quickly confirm or rule out certain types of problems. Thus, the first diagnostic step is to resolve EVM into its magnitude and phase error components (see Figure 1) and compare their relative sizes.

Setup: from digital demodulation mode, select

**MEAS DATA
DATA FORMAT**

**Error Vector: Time
Data Table**

Observe: When the average phase error (in degrees) is larger than the average magnitude error (in percent) by a factor of about five or more, this indicates that some sort of unwanted phase modulation is the dominant error mode. Proceed to measurement 2 to look for noise, spurs, or cross-coupling problems in the frequency reference, phase-locked loops, or other frequency-generating stages. Residual AM is evidenced by magnitude errors that are significantly larger than the phase angle errors.

In many cases, the magnitude and phase errors will be roughly equal. This indicates a broad category of other potential problems, which will be further isolated in measurements 3 through 6.

Measurement tip

1. The error values given in the datatable summary are the RMS averages of the error at each displayed symbol point (except GSM or MSK type I, which also include the intersymbol errors).

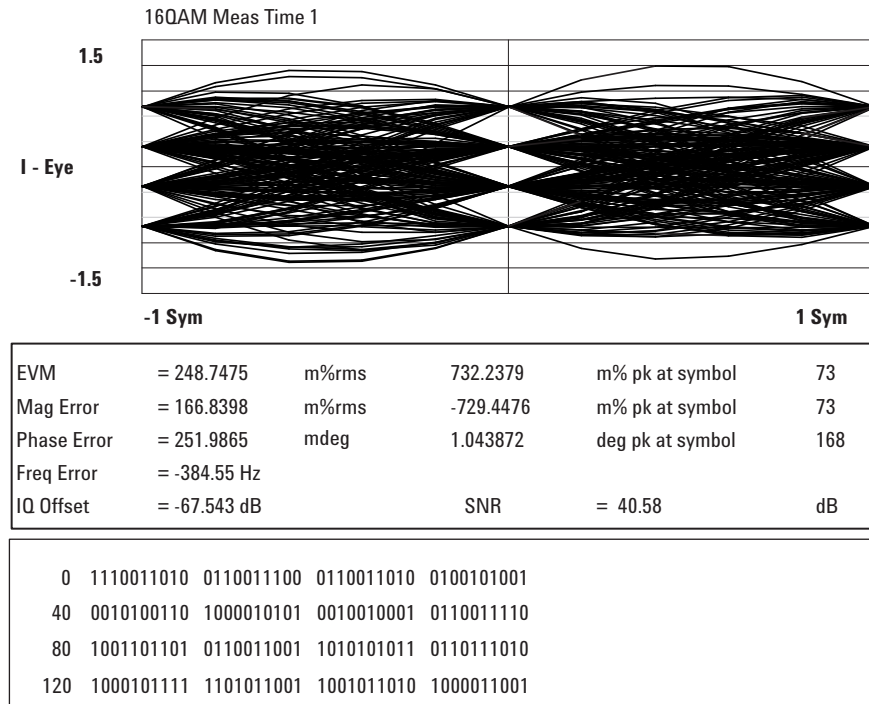

Figure 4. Data table (lower display) showing roughly similar amounts of magnitude and phase error. Phase errors much larger than magnitude errors would indicate possible phase noise or incidental PM problems.

Measurement 2

IQ phase error vs. time

Description: Phase error is the instantaneous angle difference between the measured signal and the ideal reference signal. When viewed as a function of time (or symbol), it shows the modulating waveform of any residual or interfering PM signal.

Setup: from digital demodulation mode, select

MEAS DATA **IQ Error: Phase**
DATA FORMAT **Phase**

Observe: Sinewaves or other regular waveforms indicate an interfering signal. Uniform noise is a sign of some form of phase noise (random jitter, residual PM/FM, and so forth).

Examples:

Measurement tips

1. Be careful not to confuse *IQ* Phase Error with Error Vector Phase, which is on the same menu.
2. The X-axis is scaled in symbols. To calculate absolute time, divide by the **symbol rate**.
3. For more detail, expand the waveform by reducing **result length** or by using the **X-scale markers**.
4. The practical limit for waveform displays is from dc to approximately (symbol rate)/2.
5. To precisely determine the frequency of a phase jitter spur, create and display a user-defined math function FFT(PHASEERROR). For best frequency resolution in the resulting spectrum, reduce **points/symbol** or increase **result length**.

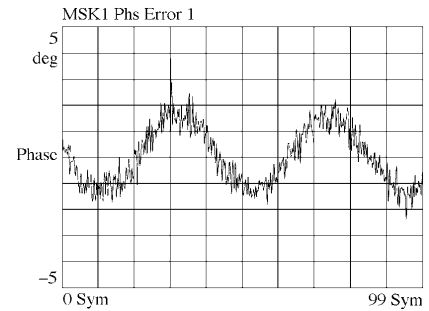

Figure 5. Incidental (inband) PM sinewave is clearly visible—even at only 3 degrees pk-pk.

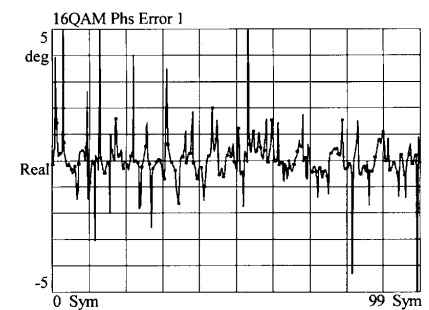

Figure 6. Phase noise appears random in the time domain.

Measurement 3

Constellation diagram

Description: This is a common graphical analysis technique utilizing a polar plot to display a vector-modulated signal's magnitude and phase relative to the carrier, as a function of time or symbol. The phasor values at the symbol clock times are particularly important, and are highlighted with a dot. In order to accomplish this, a constellation analyzer must know the precise carrier and symbol clock frequencies and phases, either through an external input (traditional constellation displays) or through automatic locking (Agilent 89400).

Setup: from digital demodulation mode, select

MEAS DATA	I/Q Measured Time
DATA FORMAT	Polar: Constellation

or

Polar: Vector
(dots plus intersymbol paths)

Observe: A perfect signal will have a uniform constellation that is perfectly symmetric about the origin. *I-Q* imbalance is indicated when the constellation is not "square," that is when the *Q*-axis height does not equal the *I*-axis width. Quadrature error is seen in any "tilt" to the constellation.

Measurement tips

1. **Result length** (number of symbols) determines how many dots will appear on the constellation. Increase it to populate the constellation states more completely.

2. **Points/symbol** determines how much detail is shown between symbols. To see peaks and overshoot, use four or more points/symbol.

To allow a longer result length, use fewer points (in either case, **result length x points/symbol** must be less than **max time points**). One point per symbol creates trivial eye and constellation diagrams, because no intersymbol data is collected and all symbols are connected by straight, direct lines.

3. To view the spreading of symbol dots more closely, move the marker to any desired state, press **mkr -> ref lvl** and then decrease **Y/div**.

4. With **normalize ON**, the outermost states will always have a value of 1.000. With **normalize OFF**, the values are absolute voltage levels.

Examples:

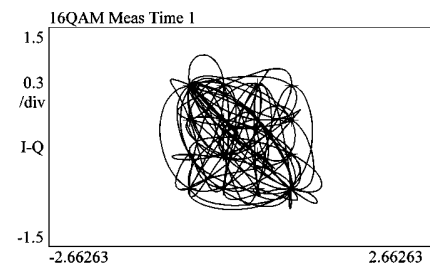

Figure 7. Vector display shows signal path (including peaks) between symbols.

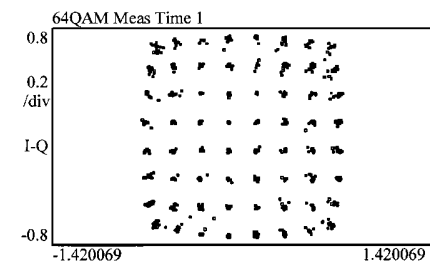

Figure 8. Constellation display shows symbol points only, revealing problems such as compression (shown here).

Measurement 4

Error vector magnitude vs. time

Description: EVM is the difference between the input signal and the internally generated ideal reference. When viewed as a function of symbol or time, errors may be correlated to specific points on the input waveform, such as peaks or zero crossings. EVM is a scalar (magnitude-only) value.

Example:

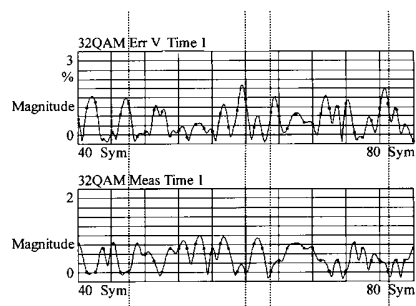

Figure 9. EVM peaks on this signal (upper trace) occur every time the signal magnitude (lower trace) approaches zero. This is probably a zero-crossing error in an amplification stage.

Setup: from digital demodulation mode, select

DISPLAY two grids
MEAS DATA (A) error vector: time
 (B) IQ measured time
DATA FORMAT (A) linear magnitude
 (B) linear magnitude
MARKER couple markers: ON

Observe: With markers on the two traces coupled together, position the marker for the upper (EVM) trace at an error peak. Observe the lower trace to see the signal magnitude for the same moment time. Error peaks occurring with signal peaks indicate compression or clipping. Error peaks that correlate to signal minima suggest zero-crossing non-linearities.

The view of EVM vs. time is also invaluable for spotting setup problems.

Measurement tips

1. EVM is expressed as a percentage of the outermost (peak) state on the constellation diagram.
2. The X-axis is scaled in symbols. To calculate absolute time, divide by the **symbol rate**.
3. For more detail, expand the waveform by reducing **result length** or by using the **X-scale markers**.
4. With **points/symbol** >1, the error between symbol points can be seen. An EVM peak between each symbol usually indicates a problem with baseband filtering—either a misadjusted filter or an incorrect value for **alpha** entered into the analyzer during setup.
5. The EVM waveform can also highlight the following setup problems:

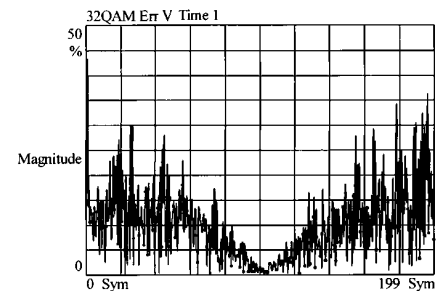

Figure 10. V-shaped EVM plot due to incorrect symbol clock rate

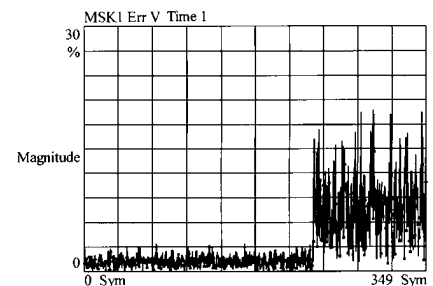

Figure 11. EVM becomes noise at end of TDMA burst; use shorter **result length**

Measurement 5

Error spectrum (EVM vs. frequency)

Description: The error spectrum is calculated from the FFT¹ of the EVM waveform, and results in a frequency domain display that can show details not visible in the time domain. Note the following relationships which apply to the error spectrum display:

$$\text{frequency span} = \frac{\text{points/symbol} \times \text{symbol rate}}{1.28}$$

$$\text{frequency resolution} \sim \frac{\text{symbol rate}}{\text{result length}}$$

Setup: from the digital demodulation mode, select

MEAS DATA **error vector: spectrum**
DATA FORMAT **log magnitude**

Observe: The display shows the error-noise spectrum of the signal, concentrated within the bandpass and then rolling off rapidly on either side. In most digital systems, non-uniform noise distribution or discrete signal peaks indicate the presence of externally coupled interference.

Measurement tips

1. To change the span or resolution of the EVM spectrum, adjust only the points/symbol or the result length according to the equations given above. Do not adjust the analyzer's center frequency or span, or the signal will be lost!

2. With a linear magnitude display, spectrum calibration is EVM percent. With log magnitude, it is in decibels relative to 100% EVM.

3. Averaging in the analyzer is applied prior to demodulation; thus, the error spectrum cannot be smoothed beyond what is shown.

4. Frequency calibration is absolute, with the carrier frequency in the center. Use the offset marker to determine specific interference frequencies relative to baseband.

Example:

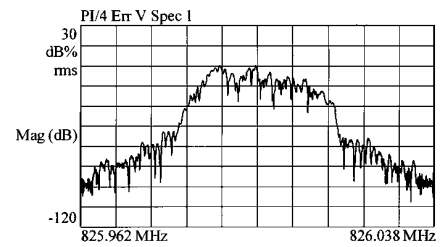

Figure 12. Interference from adjacent (lower) channel causes uneven EVM spectral distribution.

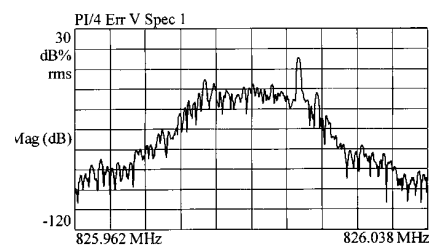

Figure 13. Switching power supply interference appears as EVM spur, offset from the carrier by 10 kHz.

1. Fast Fourier Transform

Measurement 6

Channel frequency response

Description: This powerful, unique Agilent 89400 measurement calculates the ratio of the measured signal to the reference signal. Because the latter is internally generated and ideal, it allows a frequency response measurement to be made across an entire modulated system without physically accessing the modulator input. Having this virtual baseband access point is important because in most cases, such a stimulus point is usually unavailable, either because it is a) inaccessible, b) digitally implemented, or c) the aggregate of separate *I* and *Q* inputs.

Setup: from the digital demodulation mode, select

MATH

Define Function: F1 = MEASSPEC/REFSPEC

MEAS DATA
DATA FORMAT

F1
log magnitude
phase
group delay

or
or

Observe: The measurement results show the aggregate, complex transfer function of the system from the baseband *I* and *Q* inputs of the modulator to the point of measurement. View the results as a magnitude ratio (frequency response), a phase response, or even as group delay. In high performance modulators, even the smallest deviation from flat response/linear phase can cause serious performance problems.

Examples:

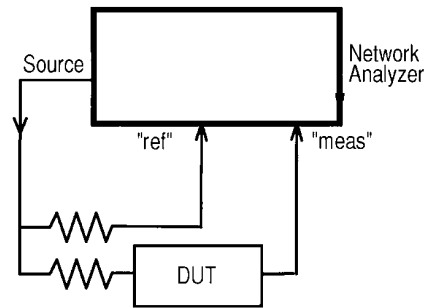

Figure 14. In traditional network analysis, the stimulus signal does not need to be perfect (flat, noise-free, etc.). It is carefully measured at the DUT input and then ratioed out of the measurement results.

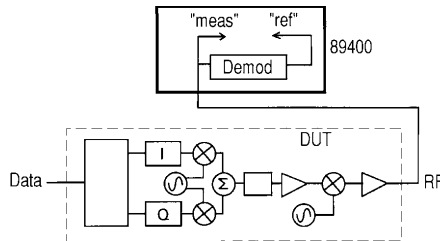

Figure 15. With an 89400, the DUT input signal does not need to be measured or even provided, because it is calculated (regenerated) from the measured signal, and is already in ideal form.

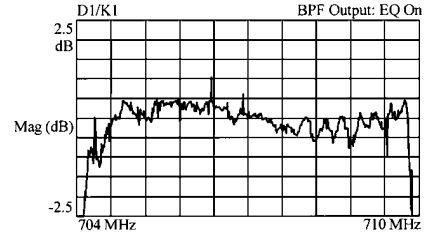

Figure 16. The flatness of this digital TV transmitter is about ± 0.5 dB from the modulator input to the power amplifier output, with the transmit equalizer on. This measurement required no interruption of the video transmission.

Measurement tips

1. See measurement tips under Measurement 5 “Error spectrum” regarding how to adjust frequency span and flatness.
2. Use this technique primarily to measure passband flatness. Dynamic range is generally insufficient for stopband rejection measurements.
3. With **data format:phase**, the deviation from linear-phase response is easy to read, because automatic carrier locking has already removed any phase slope.
4. This is typically a rather noisy measurement, because the distribution of energy across the passband is uneven and constantly varying. Thus, the SNR¹ of any individual frequency point can vary dramatically from one measurement to the next. Averaging is applied prior to demodulation and will not help. For **group delay** measurements, choose a wide **aperture** to smooth out the data.
5. Traces may be averaged manually using trace math as follows: save a measurement into D1; then change to a display of $F2 = (F1 + D1) / K1$, with F1 as defined above, and the number of measurements to be taken stored in K1. As each measurement is made, save the resulting trace into D1, repeating until all K1 measurements have been taken.

Bibliography

- Blue, Kenneth J. et al. “Vector Signal Analyzers for Difficult Measurements on Time-Varying and Complex Modulated Signals.” Hewlett-Packard Journal, December 1993, pp 6-59.
- Agilent Technologies. “Using Vector Signal Analysis in the Integration, Troubleshooting and Design of Digital RF Communications Systems,” Product Note 89400-8, Publication Number 5091-8687E, Palo Alto, CA. 1994.
- Voelker, Kenneth M. “Apply Error Vector Measurements in Communications Design.” Microwaves & RF, December 1995, pp 143-152.

Agilent Technologies' Test and Measurement Support, Services, and Assistance

Agilent Technologies aims to maximize the value you receive, while minimizing your risk and problems. We strive to ensure that you get the test and measurement capabilities you paid for and obtain the support you need. Our extensive support resources and services can help you choose the right Agilent products for your applications and apply them successfully. Every instrument and system we sell has a global warranty. Support is available for at least five years beyond the production life of the product. Two concepts underlie Agilent's overall support policy: "Our Promise" and "Your Advantage."

Our Promise

"Our Promise" means your Agilent test and measurement equipment will meet its advertised performance and functionality. When you are choosing new equipment, we will help you with product information, including realistic performance specifications and practical recommendations from experienced test engineers. When

you use Agilent equipment, we can verify that it works properly, help with product operation, and provide basic measurement assistance for the use of specified capabilities, at no extra cost upon request. Many self-help tools are available.

Your Advantage

"Your Advantage" means that Agilent offers a wide range of additional expert test and measurement services, which you can purchase according to your unique technical and business needs. Solve problems efficiently and gain a competitive edge by contracting with us for calibration, extra-cost upgrades, out-of-warranty repairs, and on-site education and training, as well as design, system integration, project management, and other professional services. Experienced Agilent engineers and technicians worldwide can help you maximize your productivity, optimize the return on investment of your Agilent instruments and systems, and obtain dependable measurement accuracy for the life of those products.

By internet, phone, or fax, get assistance with all your test and measurement needs.

Online Assistance

www.agilent.com/find/assist

Phone or Fax

United States:

(tel) 1 800 452 4844

Canada:

(tel) 1 877 894 4414

(fax) (905) 206 4120

Europe:

(tel) (31 20) 547 2323

(fax) (31 20) 547 2390

Japan:

(tel) (81) 426 56 7832

(fax) (81) 426 56 7840

Latin America:

(tel) (305) 269 7500

(fax) (305) 269 7599

Australia:

(tel) 1 800 629 485

(fax) (61 3) 9210 5947

New Zealand:

(tel) 0 800 738 378

(fax) (64 4) 495 8950

Asia Pacific:

(tel) (852) 3197 7777

(fax) (852) 2506 9284

Product specifications and descriptions in this document subject to change without notice.

Copyright © 1998, 2000 Agilent Technologies
Printed in U.S.A. 10/00
5966-0444E

**Agilent Technologies**

Innovating the HP Way