



HEWLETT
PACKARD

PRODUCT
NOTE NO.
8756-3

HOW TO USE THE HP 5344S SOURCE SYNCHRONIZER WITH THE HP 8350B SWEEP OSCILLATOR AND THE HP 8756A SCALAR ANALYZER

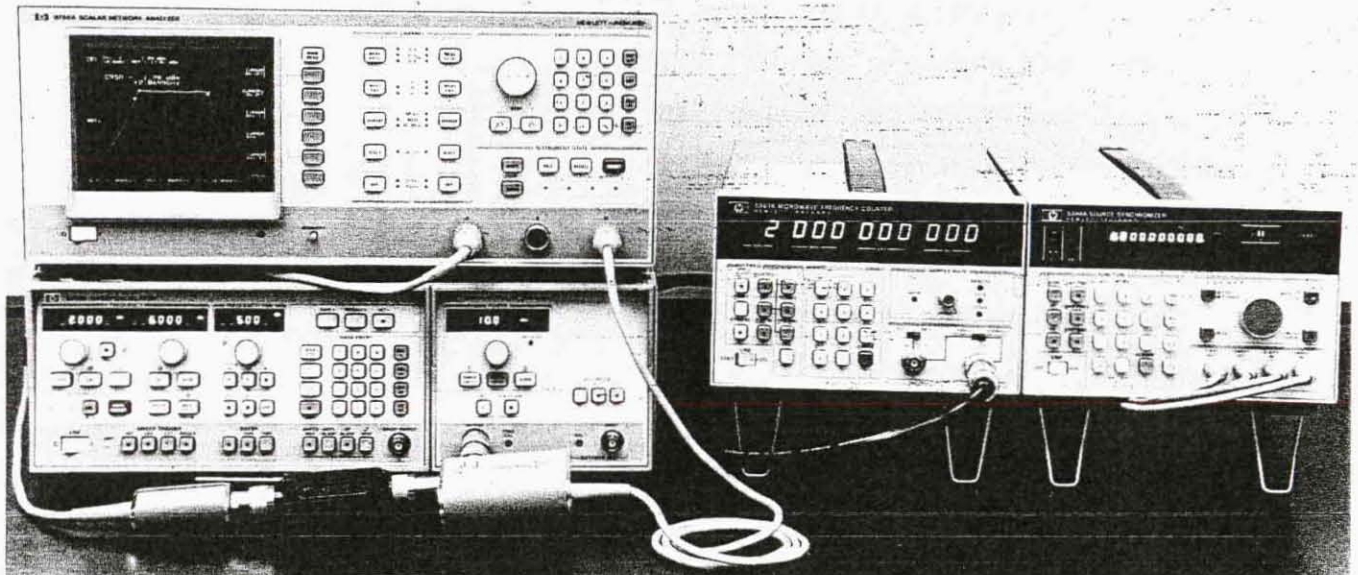

TABLE OF CONTENTS

Introduction	3
Setting Up Measurements.	3
CW	4
Locked Sweeps	5
CF/ Δ F	5
STRT/STOP	5
Lock and Roll Sweeps	6
Counting Sweeper Markers in Lock and Roll	6
Subharmonic/offset locking	7
Using subharmonic/offset locking	8
Subharmonic locking	9
Offset locking	9
Auto Lock	10
Using Auto Lock	10
Questions/Answers regarding connectors	10
Questions/Answers regarding markers	11
APPENDIX I	
List of Documents	11
APPENDIX II	
HP 5344S Error Messages	12

INTRODUCTION

The HP 8756A scalar network analyzer and the HP 8350B sweeper provide a powerful scalar analysis system for RF and microwave reflection and transmission measurements. However, some applications require greater frequency accuracy and/or stability than the HP 8350B can provide. Adding the HP 5344S source synchronizer to this system can greatly enhance the frequency accuracy and stability of scalar measurements by phase locking the sweeper output to a time base which is stable to within 5 parts in 10^9 per day. This note describes the local operation of the HP 8756A/8350B/5344S system and provides examples of a number of measurement configurations. It is intended to supplement the information available in the Operating and Service Manuals of the various instruments and several useful product notes. Appendix I contains a list of these documents and their HP part numbers.

The HP 5344S system consists of two parts, a microwave frequency counter (either an HP 5342A or an HP 5343A) and the HP 5344A microwave source synchronizer. This system can phase lock a signal source, in this case the sweeper, with 1 Hz resolution over a broad frequency range (500 MHz-18 GHz with the HP 5342A counter and 500 MHz-26.5 GHz for the HP 5343A counter). The HP 5344S also provides useful features, such as subharmonic/offset locking and AUTO LOCK. Subharmonic/offset locking can simplify the RF measurement hardware. AUTO LOCK can be used to set up the sweeper automatically while locking. These functions will be described in later sections.

SETTING UP MEASUREMENTS

Synchronized measurements can be made in four modes: CW for single frequency measurements, CF/ Δ F and STRT/STOP, both for narrowband locked sweeps up to 40 MHz wide, and LK/R for wideband "lock and roll" sweeps. This section describes in detail how to set up and perform measurements in all four measurement modes (CW, CF/ Δ F, STRT/STOP, LK/R) with a basic configuration using the 8756 System Interface, normal locking and MANUAL LOCK.

The following instructions describe how to set up the hardware for measurements in our basic configuration.

1. On the HP 5344A rear panel,
 - a) Set the MODE switch to the "NORM" position. This selects normal locking mode.
 - b) Set the LOOP BANDWIDTH switch to the "WB" position. This selects wideband locking loop bandwidth. See the HP 5344S Operating and Service Manual for details.

- c) Set the SYS CONT switch (top switch on the ADDRESS DIP switch) to the "0" position. This sets up the MANUAL LOCK mode. If this switch is in the "1" position for system control (used in AUTO LOCK) then the "CONT" annunciator will appear on the front panel of the HP 5344A.

2. On the counter, set the time base switch to the "INT" position. This selects the counter's internal time base.
3. Connect the HP-IB cable from the 8756 System Interface to the HP 8350B, as shown in figure 1.

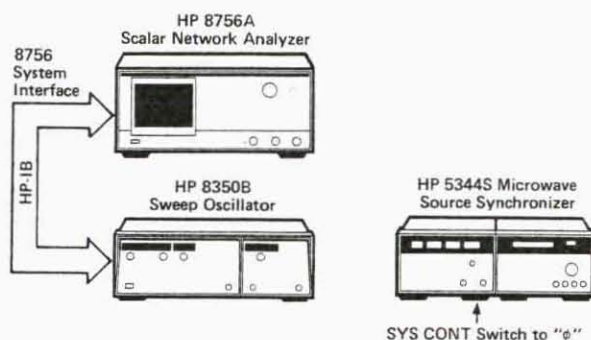
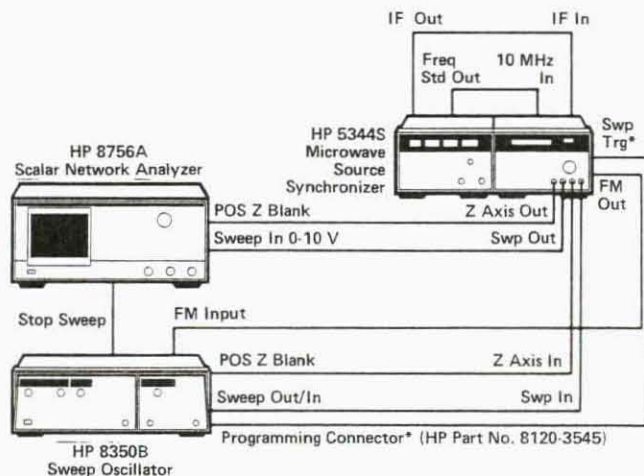

Figure 1. HP-IB connection for MANUAL LOCK.

4. Connect the cables for the control signals as shown in figure 2. In any mode, the HP 8756A requires a 0-10V sweep ramp (SWEEP IN 0-10V) and a Z axis blanking pulse (POS Z BLANK) for the display. The sweep times are determined by the device generating the sweep ramp. Figure 2 shows the system's control signals, including the sweeps, Z axis blanking, and the sweep trigger. Note that the HP 8756A display inputs, SWEEP IN and POS Z BLANK, come from the HP 5344A SWEEP OUT and Z AXIS OUT, and



*This connection is required only in Lock and Roll measurements.

the sweeper outputs, SWEEP OUT/IN and POS Z BLANK, are connected to the HP 5344A inputs, SWEEP IN and Z AXIS IN. The HP 5344A has the capability of either generating these display outputs for narrow-band sweeps or allowing them to pass through from the HP 8350B to the HP 8756A in CW and LK/R modes. This capability makes this control signal configuration very versatile.

5. Make sure your sweeper plug-in is set to be cross-over coupled. Switch number 6 on the digital interface card should be set to "0". (The plug-ins are shipped in cross-over coupled mode.)
6. Connect your RF measurement system. An example transmission measurement is shown in figure 3. Note that a power splitter or coupler and an external modulator are necessary so that the counter samples an unmodulated signal. Using subharmonic/offset locking, you can avoid using these components. This is discussed in a later section.

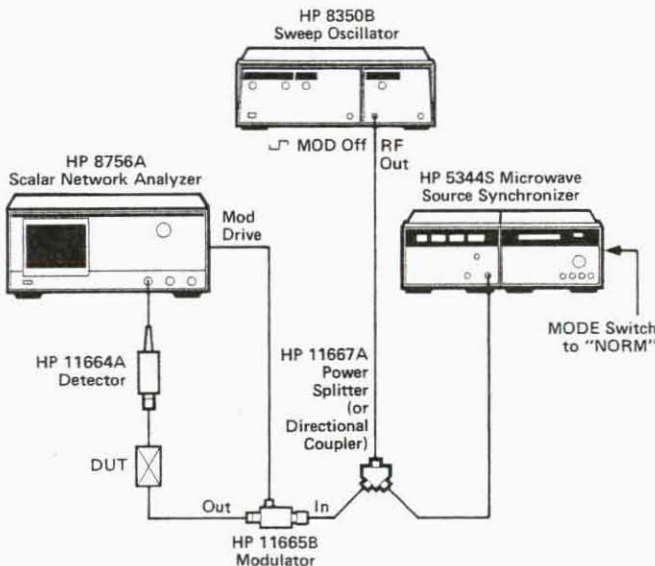

Figure 3. Transmission measurement using NORMAL LOCK.
Note that an unmodulated sample of the RF OUTPUT must be sent to the microwave counter.

7. Power on all the instruments in the system if you have not already done so. Press [PRESET] on the HP 8756A to preset both the HP 8756A and the HP 8350B.
8. Disable the square wave modulation function of the HP 8350B by pressing the [MOD] key. The square wave modulation must be done externally by the HP 8756A when using normal locking.

When using MANUAL LOCK in any mode, frequency information must be entered on both the HP 5344S and on the HP 8350B. The sweeper must be set up to operate within 25 MHz of the desired lock frequency. If the HP 8350B is set at the same frequency as the desired lock frequency entered on the HP 5344S, lock should occur with no further adjustments. The "LOCKED" annunciator light on the right hand side of the HP 5344A will come on when lock is achieved. "FREQ HI" or "FREQ LO" annunciator lights will come on when the sweeper frequency is too high or too low for the HP 5344S to achieve lock, indicating that the sweeper is not properly adjusted. When the HP 5344A detects a problem in the measurement, it will display an error message. A complete list of error messages is included in Appendix II.

CW OPERATION

This section includes instructions and an example for CW operation. In this mode the HP 8756A will display a horizontal line that shows the magnitude at a particular frequency. The sweeper generates a sweep ramp to provide for this display, but both the sweeper and the source synchronizer are fixed at one CW frequency. The example shows how to set up a CW measurement at 2 GHz.

1. Use the [MODE] key of the HP 5344A to scroll to CW mode.
2. Enter the CW frequency on the HP 5344A. Press [F1] [2] [GHz]. The HP 5344A will display 2.000000000 GHz. One Hz resolution always results.
3. On the HP 8350B, enter the CW frequency manually. To generate the proper sweep ramp for the HP 8756A display, use the swept CW mode. On the 8350B, press [SHIFT] [CW] [2] [GHz].

Note that swept CW is indicated by zeroes in the right-hand frequency display of the HP 8350B. In regular CW mode, these zeroes would not appear.

4. Check the sweep time on the HP 8350B. To be compatible with the HP 8756A, this must be at least 100 ms. Since the System Interface is operating, this will be set automatically to 200 ms. If it has been changed, you can reset it to 200 ms. Press [TIME] [2] [0] [0] [ms]. Remember, this is not a sweep over frequency, but it determines the rate of the 0-10V sweep ramp.
5. Set the HP 8350B SWEEP TRIGGER internal by pressing the [INT] key. The [INT] key should be lit.
6. Disable the RF plug-in's CW filter.

On HP 83500 series plug-ins press [CW FILTER]. On HP 86200 series plug-ins, set the rear panel FM/NORM/PL switch to PL (phase lock). "Err 05" will be displayed on the HP 5344A if you try to lock the source while the CW filter is on.

7. Press [MANUAL LOCK] to lock the source. The sweeper should lock since the CW frequency entered on the HP 8350B is the same as the CW frequency entered on the HP 5344S. When the signal is locked, the "LOCKED" annunciator should light on the HP 5344A and the counter will display the CW frequency.

The HP 8756A cursor function can be used to display the magnitude at the signal frequency. The HP 8756A will display the frequency of the sweeper setting if the 8756 System Interface is connected. The actual frequency should be read from the counter display. If the frequency is changed on the HP 5344S, that change will appear at the RF output and on the counter's display. It will not update the HP 8350B display or the HP 8756A frequency annotation. On the other hand, adjusting the sweeper frequency will change the frequency display on the sweeper and on the HP 8756A, but will not change the actual frequency from the plug-in. Any frequency changes should be made on the HP 5344A, and the frequency should be read off the counter display. When the HP 5344A loses lock, the source must be readjusted.

LOCKED SWEEPS

Locked sweeps up to 40 MHz wide can be made in the CF/ Δ F mode or in the STRT/STOP mode. The HP 8350B must be set for regular CW mode, **not swept CW**. The display signals for the HP 8756A are generated by the HP 5344S, and the sweep time will be controlled by the HP 5344A. The example in this section is a 40 MHz wide sweep centered at 2.02 GHz (from 2.00 to 2.04 GHz) with a sweep time of 200 ms. Both CF/ Δ F and STRT/STOP modes are described.

CF/ Δ F

1. Use the HP 5344A [MODE] key to scroll to CF/ Δ F mode.
2. Set the desired center frequency on the HP 5344A. This is the F1 function in this mode. Press [F1] [2] [.] [0] [2] [GHz].
3. Now set the desired frequency span, Δ F, on the HP 5344A. This is the F2 function in this mode. Press [F2] [4] [0] [MHz].
4. Set the sweep time on the HP 5344A. This **must** be at least 100 ms. Press [SWP TIME] [2] [0] [0] [ms].

5. On the HP 8350B, set the desired CW frequency to the center of the sweep. Use regular CW. Press [CW] [2] [.] [0] [2] [GHz].

Note that in regular CW mode the right-hand frequency display of the HP 8350B is off. In swept CW mode, it displays zeroes.

6. Set the HP 8350B SWEEP TRIGGER to internal by pressing the [INT] key. The [INT] key should be lit.
7. Disable the RF plug-in's CW filter. On HP 83500 series plug-ins press [CW FILTER]. On HP 86200 series plug-ins, set the rear panel FM/NORM/PL switch to PL (phase lock). "Err 05" will be displayed on the HP 5344A if you try to lock the source while the CW filter is on.
8. Press [MANUAL LOCK]. The "LOCKED" light will appear on the right, and the counter will display the **center** frequency.

STRT/STOP

STRT/STOP mode is very similar to CF/ Δ F, but instead of entering a center frequency and a frequency span, you enter the start and stop frequencies.

1. Use the HP 5344A [MODE] key to scroll to STRT/STOP mode.
2. Set the desired start frequency. This is the F1 function in this mode. Press [F1] [2] [GHz].
3. Now set the desired stop frequency. This is the F2 function in this mode. Press [F2] [2] [.] [0] [4] [GHz].
4. Set the sweep time on the HP 5344A. This **must** be at least 100 ms. Press [SWP TIME] [2] [0] [0] [ms].
5. On the HP 8350B, set the desired CW frequency to the **center** of the sweep, **not** to the start frequency. Use regular CW. Press [CW] [2] [.] [0] [2] [GHz].
Note that in regular CW, the center frequency display of the HP 8350B is off. In swept CW, it displays zeroes.
6. Set the HP 8350B SWEEP TRIGGER to internal by pressing the [INT] key. The [INT] key should be lit.
7. Disable the RF plug-in's CW filter. On HP 83500 series plug-ins press [CW FILTER]. On HP 86200 series plug-ins, set the rear panel FM/NORM/PL switch to PL (phase lock). "Err 05" will be displayed on the HP 5344A if you try to lock the source while the CW filter is on.

8. Press **[MANUAL LOCK]**. The "LOCKED" light will appear on the right, and the counter should display the start frequency.

QUESTIONS/ANSWERS

Q: I'm doing narrowband sweeps with the system interface bus connected. What will happen to the frequency annotation information of the HP 8756A?

A: The HP 8756A obtains the 0-10V sweep ramp from the HP 5344S but gets its frequency information from the HP 8350B, which is in CW mode. It will display the sweeper's CW frequency, not the HP 5344S sweep frequencies.

IMPORTANT NOTE:

Frequency adjustments should always be made on the HP 5344A until lock is lost. Then the sweeper must be readjusted to within 25 MHz of the desired lock frequency.

Q: I'm using a narrowband sweep in CF/ ΔF mode. When I reduced ΔF to zero, the sweep stopped on the HP 8756A. Why?

A: The HP 5344S treats this case as if it were in CW mode. In CW mode the HP 5344S does not generate its own sweep signal, but will pass the sweep signals through from the sweeper. The sweeper is not generating any sweep in regular CW. You need swept CW. Press **[SHIFT] [CW]** to enter the HP 8350B swept CW mode, and the sweep continues.

Q: Will this also happen in STRT/STOP with the start frequency the same as the stop frequency?

A: Yes.

Q: Can I use the HP 5344S markers to make it more convenient to analyze the trace?

A: No, not when the 8756 System Interface is operating. These markers can be used without the System Interface, as described in the section "Questions/Answers Regarding Markers" at the end of this paper.

LOCK AND ROLL SWEEPS

The HP 5344S can be used to improve the accuracy of wideband sweeps in lock and roll (LK/R) mode. The HP 5344S inhibits the HP 8350B sweep until it phase locks to the start frequency, and then releases the HP 8350B to sweep on its own. The start frequency error is essentially removed, and frequency error is thereby reduced to the linearity of the sweeper. In this mode, the sweeper generates the display signals, and the HP 5344S passes Z AXIS IN to Z AXIS OUT and SWEEP IN to SWEEP OUT. It also uses these signals to hold the sweep until it locks the HP 8350B start frequency, and then triggers the sweeper externally using the HP 5344S sweep trigger signal. In LK/R mode, HP 8350B

markers can be counted by the HP 5343A counter using the special sweeper interface of the HP 5343A. This function is detailed later.

The example shows a lock and roll sweep from 1 GHz to 20 GHz with a sweep time of 200 ms.

1. Using the **[MODE]** key on the HP 5344A, scroll to the LK/R mode.
2. Enter the desired lock frequency on the HP 5344A which should be the same as the sweeper's start frequency. This is the F1 function in this mode. Press **[F1] [1] [GHz]**.
3. Set the start frequency on the HP 8350B. Press **[START] [1] [GHz]**. This puts the sweeper in start/stop mode.
4. Then set the stop frequency on the HP 8350B. Press **[STOP] [2] [0] [GHz]**.
5. Set the sweep time on the HP 8350B. Remember, in LK/R mode, the HP 5344S triggers the sweep, but the sweeper generates it. Therefore, the sweeper controls the sweep time. Press **[TIME] [2] [0] [0] [ms]**.
6. Disable the RF plug-in's CW filter. On HP 83500 series plug-ins press **[CW FILTER]**. For 86200 series plug-ins, set the rear panel FM/NORM/PL switch to PL (phase lock). "Err 05" will be displayed on the HP 5344A if you try to lock the source while the CW filter is on.
7. Set the HP 8350B SWEEP TRIGGER to external. Press **[EXT]** under the **SWEEP TRIGGER** heading.
8. Press **[MANUAL LOCK]**. The "LOCKED" annunciator should light and the counter should display the start frequency. The HP 8756A will display the measurement data on the CRT.

COUNTING SWEEPER MARKERS IN LOCK AND ROLL

In LK/R mode with the HP 5344S opt. 43 (HP 5343A counter) the sweeper markers can be counted very accurately using the sweeper interface function of the HP 5343A. Note the sweeper interface cables A and B shown in figure 4. These outputs are available only from the HP 5343A counter and enable the marker count function. They are not necessary for normal operation. This function can be used whether or not the 8756 System Interface is operating, and can operate in either normal or subharmonic/offset locking. We now carry our example further to include counted markers.

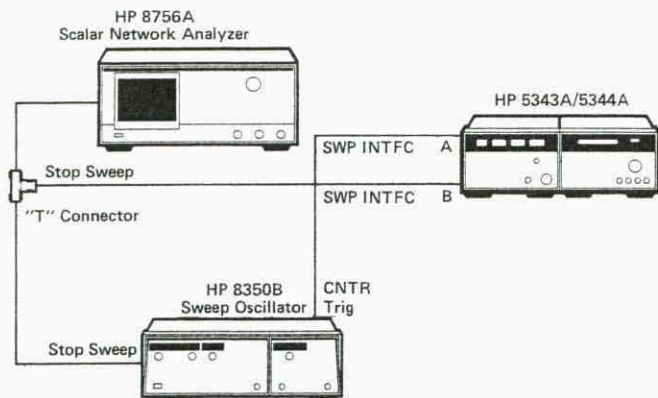

Figure 4. Connections for counting sweeper markers using sweeper interface.

Suppose you analyze the display of the HP 8756A in the LK/R measurement we have set up, and see an anomaly in the trace. You want to determine the frequency of the anomaly. To use the sweeper interface function to do this, you would follow these instructions:

1. Connect the sweeper interface cables as shown in figure 4.
2. Make sure that the HP 5344S is not trying to lock. Both **[MANUAL LOCK]** and **[AUTO LOCK]** keys should be off.
3. If you are in the NORM locking mode, activate the sweeper interface function by pressing **[SWP M]** on the HP 5343A. This function is activated automatically in SUBHMNC lock. Relock the system by pressing **[MANUAL LOCK]**.
4. To activate marker 1, press **[M1]** on the HP 8350B, and use the knob to position the marker to the anomaly on the trace. Then press **[SHIFT] [M2]** on the HP 8350B to cause the counter to count the marker instead of the lock frequency.

The counter will count the active marker, indicated by a blinking light in the corresponding marker key of the HP 8350B. The active marker can be any one of the five markers, M1-M5. In the example we activated marker one (M1), and moved it to the anomaly. We can now read the frequency of interest from the counter. The system will stop counting when you press **[SHIFT] [M3]** on the HP 8350B. Using the **[MANUAL LOCK]** key on the HP 5344A, unlock and then relock the source, and the counter will once again display the start frequency.

QUESTIONS/ANSWERS

Q: In LK/R, counting the sweeper's markers with the HP 5343A takes a long time and the knob that adjusts the

marker frequency on the HP 8350B seems slow in responding. Is there anything I can do about this?

A: When the HP 5344S comes to a marker frequency, it stops the sweeper from sweeping, and counts the frequency. This measurement takes time. High resolution measurements take more time than low resolution measurements, so the counting can be speeded up if lower resolution is used. Use the shift key and the blue resolution settings on the counter. Make sure that you are not trying to lock when you enter anything on the counter. The counter's keys are disabled if the **[MANUAL LOCK]** or **[AUTO LOCK]** keys are active.

Q: Why does the counter reading jump around so much while counting marker frequencies?

A: The sweeper is sweeping unlocked over a wide band, and because of its limitations in residual FM, resolutions greater than about 100 kHz produce unrealistically precise counter measurements.

Q: How can I count the stop frequency? The HP 5344S manual says that I can count the stop frequency by pressing **[STOP] [SHIFT] [M2]** on the HP 8350B. But this does not work.

A: Because the 8756 System Interface is operating, this particular function will be disabled. To count the stop frequency set the active marker to the same frequency as the HP 8350B stop frequency and press **[SHIFT] [M2]**.

SUBHARMONIC/OFFSET LOCKING

The instructions so far have detailed operation in normal locking mode. This section contains a description of subharmonic/offset locking, its advantages and disadvantages, and instructions on how to use it.

The MODE switch on the rear panel of the HP 5344A determines whether the HP 5344S will operate in normal (NORM) or subharmonic/offset (SUBHMNC) locking. There is a complete description of these modes in the HP 5344S Operating and Service Manual; a brief description is provided here. In the normal mode, the counter samples the plug-in's RF output directly, and no offsets or harmonics are used by the HP 5344S. Figure 3 shows a basic transmission measurement configuration in the normal locking mode. Note that a power splitter or coupler is required to sample the RF output, and external 27.8 kHz modulation is required so that the counter samples an unmodulated signal.

If the sweeper plug-in has a rear panel AUX OUTPUT (HP 83590 series and HP 86290 series RF plug-ins), then the HP 5344S subharmonic/offset locking mode can be used (see figure 5). In this mode the counter

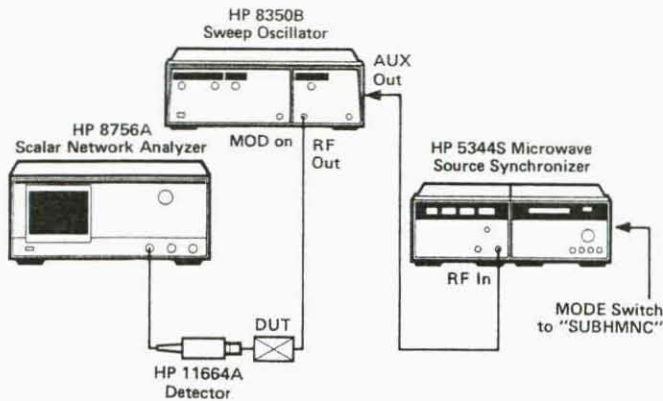

Figure 5. Transmission measurement using SUBHARMONIC/OFFSET Lock. The counter samples the rear panel AUX OUTPUT.

samples the AUX OUTPUT of the plug-in, which is the plug-in's fundamental YIG tuned oscillator (YTO) output. The frequency of this output is simply related to the RF output in one of two ways.

1. Offset locking - For HP 83590 series RF plug-ins that operate in the low frequency range (10 MHz to 2.4 GHz for the HP 83592A), the sweeper employs a heterodyne technique. The YTO frequency, sampled on the AUX OUTPUT, is mixed with a fixed cavity oscillator (3.8 GHz for all HP 83590 series plug-ins that operate in this range), to obtain a signal in the range from 10 MHz to 2.4 GHz. The back panel AUX OUTPUT is therefore offset from the front panel RF by this fixed cavity oscillator frequency. This offset must be entered manually on the counter, so it can display the RF output frequency instead of the fundamental YTO frequency.
2. Subharmonic locking - When higher frequencies are used the HP 83590 series or HP 86290 series RF plug-in uses a frequency multiplier, and

the YTO frequency on the AUX OUTPUT is harmonically related to the front panel output by an integer multiple. The HP 5344S can automatically calculate these frequency multipliers for integer values from 1 to 4, and the counter displays the multiplied RF frequency. Higher values can be entered manually.

Instructions for using the subharmonic/offset locking are included at the end of this section. Subharmonic/offset locking is strongly recommended for the HP 83590 series and the HP 86290 series RF plug-ins because of these advantages:

1. The sweeper plug-in's AUX OUTPUT is sampled, so there is no need to take costly power from the front panel RF with a coupler or power splitter.
2. The range of frequencies that can be phase locked by the HP 5344S can be extended beyond the range of the counter, because the counter always counts the fundamental YTO frequency and adjusts its display according to the offset or harmonic number. The range becomes the same as the range of the RF plug-in.
3. The internal 27.8 kHz square wave modulation function of the HP 8350B can be used, so there is no need for an external modulator. (Normal mode requires external modulation, since the counter must sample an unmodulated signal from the front panel.)

USING SUBHARMONIC/OFFSET LOCKING

If you are using any of the sweeper plug-ins listed in table 1, you can take advantage of the subharmonic/offset locking function of the HP 5344S. This enables you to use a much simpler RF configuration like the one shown in figure 5.

TABLE 1

PLUG-INS WITH AUX OUTPUT FOR SUBHARMONIC/OFFSET LOCKING

PLUG-IN	FREQUENCY RANGE (GHz)	AUX OUTPUT FREQUENCY RANGE (GHz)	RANGE OF OFFSET LOCKING (GHz)	RANGE OF SUBHARMONIC LOCKING (GHz)
HP 83570A	18.0 - 26.5	9-13.25	None	18-26.5
HP 83590A	2 - 20	2 - 7	None	2 - 20
HP 83592A	0.01 - 20	2.3 - 7	0.01 - 2.3	2.3 - 20
HP 83592B	0.01 - 20	2.3 - 7	0.01 - 2.3	2.3 - 20
HP 83592C	0.01 - 20	2.3 - 7	0.01 - 2.3	2.3 - 20
HP 83594A	2 - 26.5	2 - 7	None	2 - 26.5
HP 83595A	0.01 - 26.5	2.3 - 7	.01 - 2.3	2.3 - 26.5
HP 86251A	7.5 - 18.6	2.5 - 6.2	None	7.5 - 18.6
HP 86290A	2 - 18	2 - 6.2	None	2 - 18
HP 86290B	2 - 18.6	2 - 6.2	None	2 - 18.6
HP 86290C	2 - 18.6	2 - 6.2	None	2 - 18.6

First, determine the frequency band you will be using, and determine whether your plug-in is using a frequency multiplier technique or a heterodyne technique in the range of interest. When you place the rear panel mode switch on the HP 5344A to SUBHMNC, subharmonic locking will automatically be enabled. It is used when the sweeper plug-in uses a frequency multiplier technique. Offset locking will also be automatically enabled, but must be activated by entering the offset on the counter. Table 1 shows the plug-ins for which subharmonic/offset locking is useful. It also shows which frequency ranges should use subharmonic locking and which should use offset locking. In either subharmonic or offset locking, the AUX OUTPUT of the sweeper should be connected to the counter's microwave input.

Subharmonic locking

1. Set the rear panel MODE switch of the HP 5344A to SUBHMNC. This is indicated by a right hand decimal point on the front panel display of the HP 5344A.
2. Connect the RF measurement system, such as the one shown in figure 5. The counter input should come from the plug-in's AUX OUTPUT.
3. Make sure no offset is active in the counter. The [OFS MHz] key on the counter should be off.
4. Activate the internal square wave modulation if you are using it. Press the [MOD] key on the 8350B.
5. Set up the desired measurement according to the instructions in the appropriate section (CW, CF/ Δ F, STRT/STOP, LK/R), and lock the sweeper using either MANUAL or AUTO lock.

Any frequency multiplier greater than four must be entered manually on the HP 5344A. This is unnecessary for HP 8350B plug-ins in normal operation, since the multipliers are never greater than four, but instructions are included in the HP 5344S Operating and Service Manual.

Offset locking

To use offset locking, you must enter the offset on the counter. For all HP 8350B plug-ins that can use offset locking, this frequency is 3.8 GHz with an accuracy of better than 5 MHz. This offset can be determined more accurately by counting the main front panel output and the auxiliary rear panel output separately. The offset is then the difference between these two frequencies. We now show how to use a frequency offset of 3.8 GHz.

1. Set the rear panel mode switch of the HP 5344A to SUBHMNC. The right hand decimal on the HP 5344A display should be on.
2. Connect the RF measurement system, such as the one shown in figure 5. The counter input should come from the plug-in's AUX OUTPUT.
3. Make sure the HP 5344S is not trying to lock. The [MANUAL LOCK] and [AUTO LOCK] keys should be off.
4. Enter the offset on the counter by pressing [SET] [OFS MHz] [3] [8] [0] [0] [CHS] [ENTER]. The change sign key [CHS] is needed because we are adding a negative offset.
5. Activate the internal square wave modulation if you are using it. Press the [MOD] key on the HP 8350B.
6. Set up the desired measurement according to the instructions in the appropriate section (CW, CF/ Δ F, STRT/STOP, LK/R), and lock the sweeper using either MANUAL or AUTO lock.

QUESTIONS/ANSWERS

- Q: Sometimes I want to use an offset, but not all the time. Do I need to enter the same 3.8 GHz offset every time I change configuration?
- A: No, only when the HP 5344S is powered on. Just be sure the offset key [OFS MHz] is active when you want it to be. You can enable it and disable it by just pushing the [OFS MHz] key. To check your offset, press [RECALL] and then hold down the [OFS MHz] key. The offset will be displayed on the counter until you release the [OFS MHz] key.
- Q: The counter's keys are inactive. I can't enter anything. What's going on?
- A: That's because you are trying to lock, and the counter's keys are disabled. Unlock the source, and the counter's keys should function again.
- Q: I am counting sweeper markers in lock and roll mode with subharmonic/offset locking, and am getting strange readings. What's wrong?
- A: LK/R sweeps can be very wideband. The plug-ins typically switch over several frequency bands during a LK/R sweep. The counter has no way of knowing which band the sweeper is in, and whether to apply an offset or a harmonic number. Therefore, it displays the plug-in's fundamental YIG tuned oscillator frequency. You will need to apply the necessary offset or multiplier to the frequency displayed by the counter. Table 1 is a useful reference for this.

AUTO LOCK

The instructions so far have detailed operation using MANUAL LOCK. This section contains a description of AUTO LOCK, its advantages and disadvantages, and instructions on how to use it.

The HP 5344S can phase lock the source using either MANUAL LOCK, as already described, or AUTO LOCK. In both modes, the desired lock frequency is entered on the HP 5344S, and lock can occur with no manual tuning. AUTO LOCK requires an HP-IB connection from the HP 5344S to the HP 8350B, and cannot be used in an automatic system when an external computer is used as a controller.

The HP 8756A scalar network analyzer is also capable of HP-IB communication with the HP 8350B over a dedicated bus called the 8756 System Interface. This connection allows several powerful advantages:

1. HP 8756A CRT will display sweep frequency information and sweeper marker frequencies.
2. HP 8756A INSTRUMENT PRESET will preset both the HP 8756A and the HP 8350B.
3. Save/Recall function on either the analyzer or the sweeper will save or recall the measurement configuration of both instruments.
4. The alternate sweep function of the 8756A/8350B will be enabled.

The HP 8350B has only one HP-IB connector. It can go either to the HP 5344A HP-IB connector, or to the 8756 System Interface, but not to both. If the 8756 System Interface is used, then the sweeper cannot be controlled by the HP 5344S and therefore AUTO LOCK cannot be used (see figure 1). If the HP 5344A HP-IB is connected, the AUTO LOCK function can be used, but the advantages of the 8756 System Interface must be sacrificed (see figure 6).

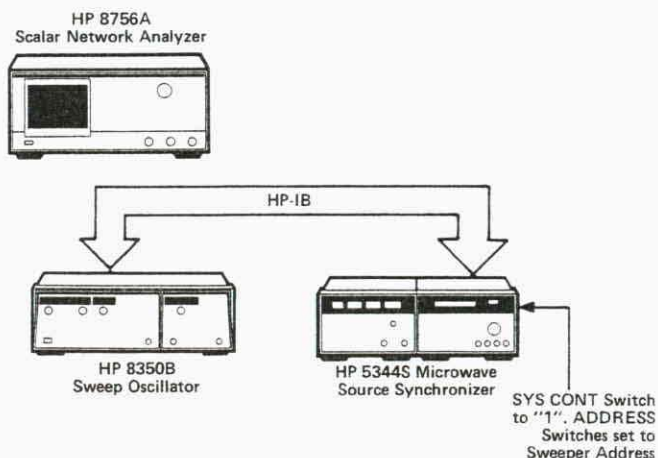

Figure 6. HP-IB connection for AUTO LOCK.

AUTO LOCK should only be used when the convenience of locking automatically is more important than the convenience added by the 8756 System Interface.

USING AUTO LOCK

In all modes, using the system in AUTO LOCK is very similar to using it in MANUAL LOCK. However, the 8756 System Interface cannot be used. AUTO LOCK requires an HP-IB connection from the HP 5344S to the sweeper (see figure 6). Note that the 8756 System Interface is not used. The DIP switch on the back panel of the HP 5344A must be set properly to run in the AUTO LOCK mode. The top switch must be set to the SYS CONT position. This will be indicated on the front by a "CONT" annunciator on the HP 5344A. The bottom five switches must be set to the HP-IB address of the HP 8350B. (This address is factory set to 19, but can be checked and reset by pressing [SHIFT], [LCL] on the HP 8350B.) The bottom switch is the least significant bit. See the HP 5344S Operating and Service Manual for details.

CW, CF/ Δ F, STRT/STOP, modes in AUTO LOCK

The instructions for operation in AUTO LOCK are essentially the same as those for MANUAL LOCK in all four HP 5344S modes. However, in AUTO LOCK, the HP 5344S can set up the mode and the frequency of the HP 8350B over HP-IB, so it is not necessary to do this manually. You will need to turn the CW filter (if any) off, and make sure the SWEEP TRIGGER mode is set to internal (INT) on the HP 8350B. In CW, be sure that the HP 8350B sweep time is set to at least 100 ms. In the final step, the [AUTO LOCK] key should be activated instead of the [MANUAL LOCK] key. The sweeper's frequency will be set automatically over HP-IB, and the 8350B mode will be set to regular CW. For single frequency measurements (CW mode on the HP 5344S), the 8350B mode must be set to swept CW. Do this by pressing [SHIFT] [CW].

LK/R mode in AUTO LOCK

When using LK/R mode in AUTO LOCK, the HP 5344S sets the sweeper to STRT/STOP mode and sets the start frequency to the lock frequency entered on the HP 5344A. However it does not set the stop frequency. This must be entered manually on the sweeper.

Also, do not forget to disable the CW filter, set the sweeper's sweep time to at least 100 ms, and set the sweep trigger to external (EXT).

QUESTIONS/ANSWERS REGARDING CONNECTORS

Q: I don't have the programming connector cable. Can I use the system without it?

A: This connector (HP Part No. 8120-3545) is used to trigger the sweep in LK/R

mode. It is not necessary for other modes. Even LK/R can be used in an alternate configuration, which ties the HP 5344A sweep trigger to the HP 8350B STOP SWEEP input. This is the optional configuration on page 3-37 of the Operating and Service Manual. Refer to that for details.

- Q: I don't have the SMC sweeper interface cables. Is there a way I can count the sweeper markers without them?
- A: No. They are included in the HP 8350B option 803. You can also order them separately (HP part no. 11592-60001).
- Q: I need four BNC connectors for the sweep and Z axis signals. Can't I eliminate some of them?
- A: Yes, in some modes. Only Lock and Roll requires all four. Narrowband sweeps only require connections from the HP 5344S to the HP 8756A, and the connections from the HP 8350B to the HP 5344S can be removed (see figure 7).

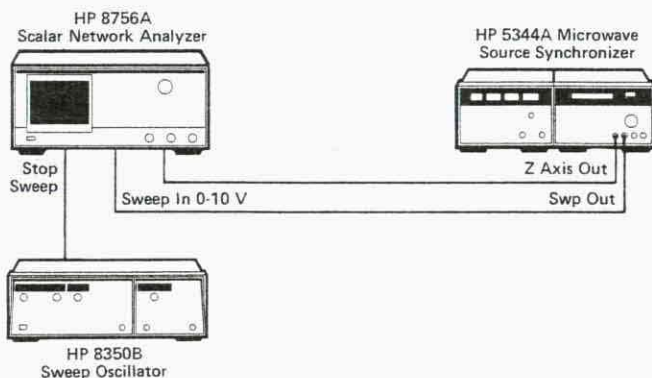

Figure 7. Alternate routing of display signals for narrowband sweeps.

In CW measurements, the sweep and Z axis signals can go straight to the HP 8350B, and no connections to the HP 5344A front panel are necessary (see figure 8). Remember, though, that the original configuration of figure 3 can operate in any mode, and therefore is very convenient.

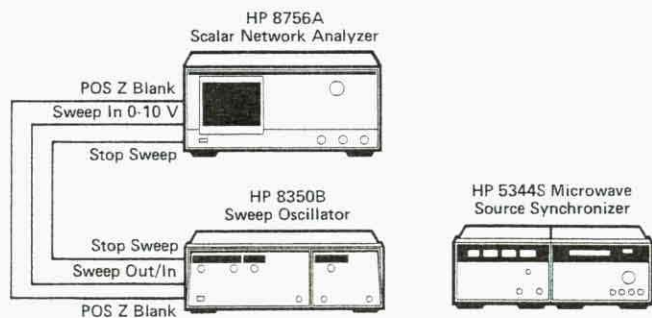

Figure 8. Alternate routing of display signals in CW mode.

QUESTIONS/ANSWERS REGARDING MARKERS

- Q: Doesn't the HP 5344S generate markers? Can those be displayed on the HP 8756A?
- A: Yes, their operation is described in the Operating and Service Manual of the HP 5344S. But they will not show up on the display of the HP 8756A if the 8756 System Interface is operating. Therefore, if you are using the 8756 System Interface, you will need to disconnect it to view the HP 5344S markers. If you disconnect, then reconnect the interface bus, you will need to preset the HP 8756A to enable the interface again.

Briefly, the markers are set by pressing [MKR FREQ] on the HP 5344A and then the marker number 1-4. This displays the present marker and allows you to enter a new value or to adjust it with the knob. You should then see the marker on the display as long as the 8756 System Interface is not operating.

- Q: Should I use the HP 8350B markers or the HP 5344S markers?

A: It depends. Markers are generated by the sweeping device. In narrowband sweeps, the HP 5344S is sweeping, so its markers should be used. In LK/R, the HP 8350B is sweeping, so its markers should be used.

In narrowband sweep, up to four frequencies can be marked, and magnitude measurements can be made at very accurate frequencies. In wideband LK/R sweeps up to five points can be marked, and the frequency can be measured by the counter with high accuracy.

- Q: So if I don't use the Interface Bus because I want to use the HP 5344S markers, then I might as well use AUTO LOCK, right?

A: Yes, because you don't use the 8756 System Interface in AUTO LOCK. This is a good way to do narrowband sweeps, but can not take advantage of the 8756 System Interface.

APPENDIX I

List of Documents

- HP 5344S Operating and Service Manual
HP part no. 05344-90009
- HP 8756A Operating and Service Manual
HP part no. 08756-90001
- HP 8350B Operating and Service Manual
HP part no. 08350-90034
- HP 5344S Microwave Source Synchronizer
Product Note 5344S-1; HP lit. no. 02-5952-7649
- Operating Note: Basic Network Measurements Using 8756A Scalar Network Analyzer and 8350B Sweep Oscillator (HP part no. 08756-90001)

APPENDIX II

ERROR NUMBER	ERROR DESCRIPTION
01.	<p>Invalid frequency measurement on 5344S.</p> <ul style="list-style-type: none"> a. Signal source output not connected to counter input. b. Source power level too low. c. Source RF OUT turned off. d. Source RF BLANKING turned on when using Lock/Roll mode on the 5344S. e. Signal source frequency <500 MHz or >18 [26.5] GHz. f. Signal source sweeping or being tuned too fast. g. Signal source internal square wave modulation turned on.
02.	<p>Markers too close to each other or to the stop frequency.</p> <ul style="list-style-type: none"> >Move markers. >Increase sweep time.
03.	<p>STOP frequency less than START frequency.</p>
04.	<p>(STOP frequency) – (START frequency) greater than 40 MHz.</p> <ul style="list-style-type: none"> >Reduce sweep span.
05.	<p>Signal source FM sensitivity less than 1 MHz/volt.</p> <ul style="list-style-type: none"> a. Sensitivity is less than 1 MHz/volt. b. 5344A FM OUT not connected to signal source FM input. c. For 86200 series plug-ins: PL-NORM-FM switch in NORM position. (Should be in PL position). d. For 83500 series plug-ins: CW filter enabled e. 5344A A6 (Main Loop Board) fuse blown.
06.	<p>Signal source FM sensitivity greater than 50 MHz/volt.</p>
07.	<p>Sweep too wide for signal source sensitivity.</p> <ul style="list-style-type: none"> >Reduce sweep width. >Increase source FM sensitivity.
08.	<p>Sweep cannot cross the frequencies of 500, 650 or 800 MHz.</p> <ul style="list-style-type: none"> >Change sweep parameters.
09.	<p>Invalid value calculated for frequency multiplier in subharmonic locking mode.</p> <ul style="list-style-type: none"> a. Sweeper is not tuned close enough to desired frequency to allow reliable automatic determination of harmonic number. <ul style="list-style-type: none"> >Tune source closer to the correct frequency. >Use Auto Lock b. The 5344S has determined that the harmonic number is greater than four. <ul style="list-style-type: none"> >Enter the frequency multiplier manually.
10.	<p>System controller switch not set to SYS.CONT. for Auto Lock.</p> <ul style="list-style-type: none"> >Turn on system controller switch. >Use Manual Lock.
11.	<p>Signal source cannot be tuned close enough via HP-IB.</p> <ul style="list-style-type: none"> a. Source is not connected to the HP-IB port of the 5344A. b. 5344A HP-IB address is not set to the address of the source. c. The source is not an HP 8350B or 8620C opt. 011. d. The desired frequency is not within the range of the installed plug-in. e. The 8620C has a plug-in installed that is not supported for Auto Lock (e.g. 8621A/B).
12.	<p>Auto Lock cannot be achieved</p> <ul style="list-style-type: none"> a. Source is 8620C and Lock/Roll mode is desired. <ul style="list-style-type: none"> >Use Manual Lock for Lock/Roll mode with the 8620C. b. 5344A HP-IB address is not set to the address of the source.
13.	<p>Checksum error in power-up ROM test; the bad ROM is also displayed.</p>
14.	<p>RAM failure during power-up self test.</p>
15.	<p>Input frequency to the 5344S out of range (<500 MHz or >18 [26.5] GHz) in Subharmonic or Offset Locking mode.</p>

4-125