

Errata

Document Title: Analyzing Phase-Locked Loop Transients in the Modulation Domain
(AN 358-7)

Part Number: 5952-8001

Revision Date: October 1989

HP References in this Application Note

This application note may contain references to HP or Hewlett-Packard. Please note that Hewlett-Packard's former test and measurement, semiconductor products and chemical analysis businesses are now part of Agilent Technologies. We have made no changes to this application note copy. The HP XXXX referred to in this document is now the Agilent XXXX. For example, model number HP8648A is now model number Agilent 8648A.

About this Application Note

We've added this application note to the Agilent website in an effort to help you support your product. This manual provides the best information we could find. It may be incomplete or contain dated information, and the scan quality may not be ideal. If we find a better copy in the future, we will add it to the Agilent website.

Support for Your Product

Agilent no longer sells or supports this product. You will find any other available product information on the Agilent website:

www.agilent.com

Search for the model number of this product, and the resulting product page will guide you to any available information. Our service centers may be able to perform calibration if no repair parts are needed, but no other support from Agilent is available.

Application Note 358-7

Analyzing Phase-Locked Loop Transients in the Modulation Domain

HP 5372A
Frequency and Time
Interval Analyzer

Description

Phase-Locked Loops (PLLs) are common yet essential circuits in many electronic applications. They may be used as narrow-band filters to recover signals embedded in noise, or for synchronizing digital transmissions in communication applications. Other traditional uses include frequency demodulators, multipliers, dividers, and much more.

A typical loop consists of a phase detector, low-pass filter, voltage controlled oscillator and frequency divider (Figure 1).

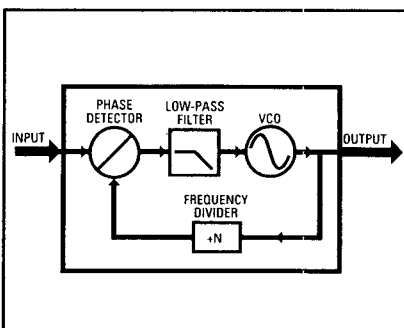

Figure 1. Typical phase-locked loop block diagram.

Problem

The analysis of phase-locked loops is challenging. Components can be assessed individually, but closed loop characterization is often difficult to obtain.

Both transient response and frequency response are of interest to the analog designer. Ideally, PLL transient behavior should be characterized when time domain issues such as loop settling time and dynamic response performance are critical for the application.

This application note will address methods for analyzing the transient response of a PLL with the HP 5372A Frequency and Time Interval Analyzer after stimulating the input with a step change in phase. This time domain response is useful for determining loop parameters such as rise time, ringing, overshoot, and settling time.

- *View Phase-Locked Loop (PLL) step response on a "phase oscilloscope"*
- *Analyze all loop settling characteristics: settling time, overshoot, and rise time*
- *Analyze ringing with built-in modulation analysis*
- *Make high resolution phase measurements (< 1 degree on 10 MHz signals)*
- *Fully characterize PLL without using a coherent reference*

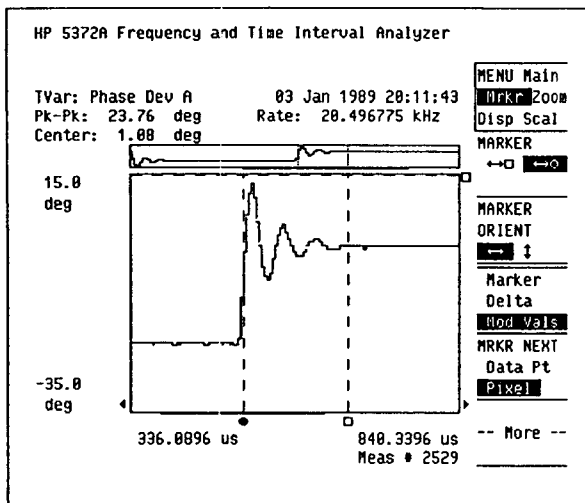

Figure 2.
Phase
Deviation
versus time
plot showing
phase-locked
loop step
response.

HP 5372A Frequency and Time Interval Analyzer

Solution

The HP 5372A Frequency and Time Interval Analyzer makes single-channel phase measurements and displays the phase deviation of a signal versus time. Up to 8191 phase measurements can be stored in internal memory and shown on the display. Using the HP 5372A's display features and built-in modulation analysis, it is easy to capture and analyze the transients of a phase step.

Figure 2 shows a typical plot of phase deviation versus time for a PLL that has been stepped. The vertical axis is phase, and the horizontal axis is time. From the graph it is easy to see the rise time, phase overshoot, and settling characteristics.

Also, the undamped natural frequency of the PLL is shown at the top of the display screen under "Rate". The PLL's ringing frequency is computed between the two vertical markers using the HP 5372A's modulation analysis capability.

- View Phase-Locked Loop (PLL) step response on a "phase oscilloscope"
- Analyze all loop settling characteristics: settling time, overshoot, and rise time
- Analyze ringing with built-in modulation analysis
- Make high resolution phase measurements (< 1 degree on 10 MHz signals)
- Fully characterize PLL without using a coherent reference

Measurement Considerations

An equipment setup for measuring PLL transient response is shown in Figure 3. An HP 8663A Synthesized Signal Generator with Option 002 Phase Modulation is phase modulated with a 1 kHz square wave from an HP 3325B Synthesizer/Function Generator to provide about a 20 degree phase step change to the input of the PLL.

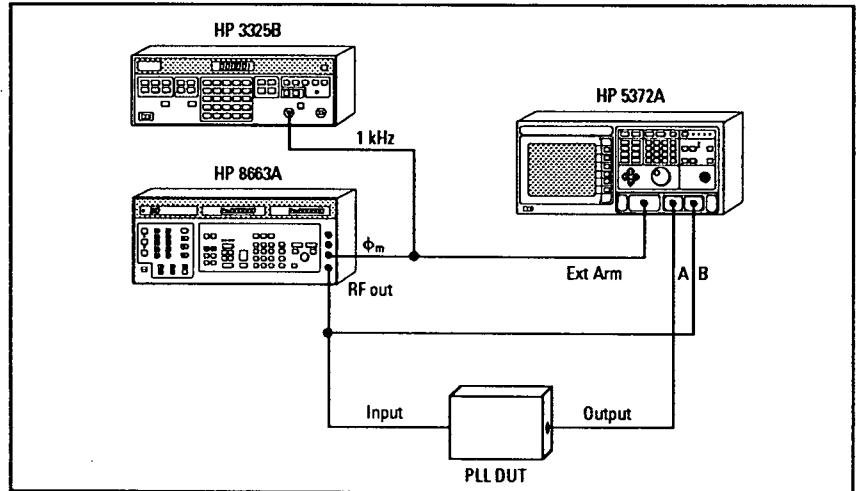

Figure 3. Equipment block diagram to measure PLL phase step response.

In this example, the device under test (DUT) is a PLL used to lock an oscillator to an external reference. This PLL has a loop bandwidth of approximately 35 kHz and an output frequency of 10 MHz.

PLL Settling Time

Before setting up the HP 5372A, you must know the approximate settling time of the PLL under test. Knowing the total time you want to view settling of the PLL will determine the frequency with which to phase modulate the carrier with a square wave (stepped stimulus). This frequency is then used to determine the total measurement time. By knowing the total measurement time, the necessary sampling rate and number of measurements can be determined.

1. Modulation Period

The period of the modulation should be twice the total time you want to view settling characteristics on the PLL.

$$\text{Modulation Period} = 2 \times \text{PLL Settling Time}$$

2. Total Measurement Time

The total measurement time should be equal to one period of the square wave modulation.

$$\text{Total Measurement Time} = \text{Modulation Period}$$

For example, if the total time you want to view the settling characteristics is 500 μ s, the frequency of the square wave modulation should be 1 kHz. The total measurement time will be 1 ms. This way you will display measurements 500 μ s before the step, and 500 μ s after. The stepped edge of interest will appear in the center of the HP 5372A display screen.

3. Sampling Rate and Number of Measurements

To set up the HP 5372A you need to select a sampling rate and the number of measurements. The total measurement time is a product of the sampling interval and the number of measurements.

$$\text{Total Measurement Time}^* = \text{Sampling Interval} \times \text{Number of Measurements}$$

The HP 5372A is capable of storing 8191 phase measurements, and sampling those measurements at intervals from 100 ns to 8 seconds in 100 ns increments.

To get the best time (or horizontal) resolution, you will want to sample as fast as possible. If,

$$\frac{\text{Total Measurement Time}}{100 \text{ ns}} < 8K,$$

then sample at 100 ns. If not, increment the sampling interval by 100 ns until this condition is met.

Phase Resolution

The single-shot phase resolution can be determined by knowing the frequency at the output of the PLL. In general,

$$\text{Phase Resolution (LSD)} = 200 \text{ ps} \times \text{Output Frequency} \times 360^\circ$$

Since the resolution is proportional to the PLL output frequency, greater resolution can be obtained by downconverting the PLL output signal with additional external hardware. During the downconversion, phase integrity is maintained, and resolution is improved.

Signal Thresholds

A voltage threshold and slope must be given to the HP 5372A to define the point at which the input signal is detected. The HP 5372A trigger levels should be set approximately to the 50% point of the PLL peak-to-peak output voltage.

This can be done either automatically or manually with the HP 5372A. For signals between 1 kHz and 200 MHz, the HP 5372A can automatically determine the trigger threshold as a percentage of the peak-to-peak signal amplitude. Conversely, if you wish to specify the trigger event as a voltage level, it can be done manually.

* This holds true except when the period of the carrier is greater than the sampling interval. In this case, the total measurement time equals the period of the carrier times the number of measurements.

Measurement Setup

1. Preset

Start by pressing the green **Preset** key. Preset brings up the **FUNCTION** menu (Figure 4). Then press the **Single/Repeat** key to put the HP 5372A into single measurement mode. The LED next to the key should be on.

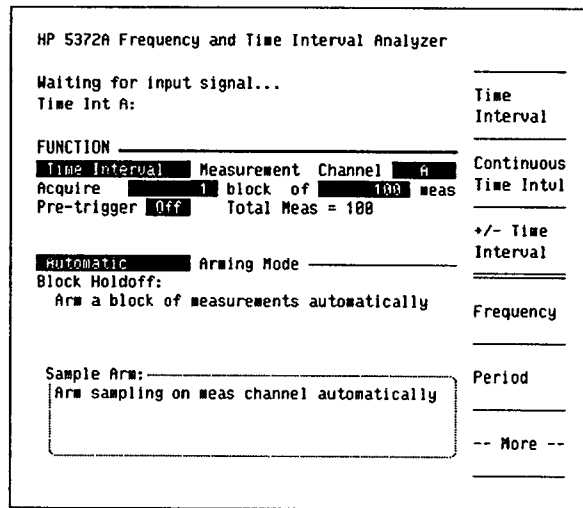

Figure 4. HP 5372A display screen after pushing the Preset key.

Function Menu



2. Select the Measurement Function

Time Interval will be highlighted on the CRT. Press the **--More--** softkey until **Phase Deviation** is an option. Select **Phase Deviation** on Channel **A** to measure the PLL output response (Figure 5). (To check that the input signal is as expected, you may want to measure it as well. To measure the input, attach it to Channel **B**, select Channel **B**, and use this same setup procedure.)

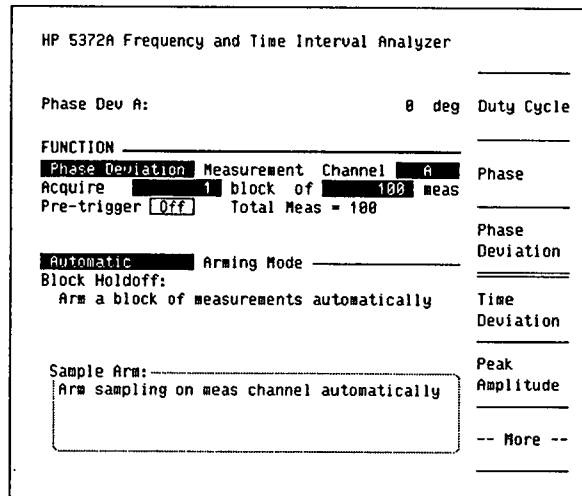

Figure 5. Select a Phase Deviation measurement on the FUNCTION menu.

3. Select the Number of Measurements and the Arming Mode.

Move to the Arming Mode field on the menu using the arrow keys.

Press the topmost softkey until **Hld/Samp** (Holdoff/Sampling) is highlighted. Then select **Edge/Interval** arming mode. A "Holdoff" is used to holdoff the start of a block of measurements. In this case, the holdoff is a signal edge. "Sampling" is used to pace the measurements within the block. In this case, the sampling will be paced by an interval, analogous to a gate time. Set the Block Holdoff condition to "After **Pos** edge of **Ext Arm**. Arm a block of measurements" (Figure 6). This means the HP 5372A will holdoff the start of the measurement until after the positive edge of the square wave from the HP 3325B Function Generator.

```
HP 5372A Frequency and Time Interval Analyzer

Phase Dev A:          400 mdeg      Pos
-----
FUNCTION
Phase Deviation Measurement Channel A      Neg
Acquire 1 block of 100 meas
Pre-trigger Off Total Meas = 100
-----
Edge/Interval Arming Mode
Block Holdoff:
After Pos edge of Ext Arm,
Arm a block of measurements
-----
Sample Arm:
Following the block arming condition,
Arm sampling on meas channel after
200 ns intervals
-----
Acquisition Time/Block = 20.0 us
```

Figure 6. Selecting **EDGE/INTVL** arming mode on the **FUNCTION** menu.

Since the modulation rate is 1 kHz, acquire 1 ms of phase measurements. Recalling the procedure outlined on page 3, select the sampling interval and number of measurements.

Number of Measurements = Total Measurement Time/Sampling Interval

Sampling at the fastest rate,

$$1 \text{ ms}/100 \text{ ns} = 10,000 \text{ measurements.}$$

Since the HP 5372A can only acquire 8K measurements, select 200 ns as the sampling interval by highlighting the interval field and entering 200 from the keypad, then pressing the **ns** softkey.

Using a 200 ns sampling interval, with a total measurement time of 1 ms, the measurement size required is 5000.

Move the cursor up to the measurement size field on the **FUNCTION** menu. Enter 1 block of 5000 measurements. (For numeric entries, you must press **Enter** for the HP 5372A to complete the entry.) (See Figure 7.)

```

HP 5372A Frequency and Time Interval Analyzer

Phase Dev A:                               0 deg

FUNCTION
Phase Deviation Measurement Channel A
Acquire 1 block of 5000 meas
Pre-trigger Off      Total Meas = 5,000

Edges/Interval Arming Mode
Block Holdoff:
After Pos edge of Ext Arm,
Arm a block of measurements

Sample Arm:
Following the block arming condition,
Arm sampling on meas channel after
200 ns intervals

Acquisition Time/Block = 1.0000 ms

```

Figure 7. FUNCTION menu configured for measuring Phase Deviation.

Input Menu



4. Specify the Input Conditions

To set the HP 5372A input trigger levels, press the **Input** hardkey (Figure 8). Select **Separate** input channels to keep the input channels independent. Channels A, B and the External Arm inputs are used for this measurement. If installed, the optional Channel C can be ignored.

```

HP 5372A Frequency and Time Interval Analyzer

Phase Dev A:                               0 deg Separate

INPUT
Separate Input Channels                Common
Trigger Event:
Slope Mode Level
Chan A: Pos Sgl Auto 50 % = 50 mV
Chan B: Pos Sgl Auto 50 % = 0 V
Chan C: POS MANUAL 0 V
Ext Arm Level 0 V

Channel A Channel B Channel C
Input Pod HP 54002A HP 54002A -----
Impedance 50 Ω 50 Ω 50 Ω
Bias Level GND GND GND
Attenuation 1:1 1:1 0 %
Hysteresis Min Min -----
Max Input 2 V peak 2 V peak +20 dBm

```

Figure 8. INPUT menu configuration after pressing Preset.

Move down to the next field and enter respectively **Pos**, **Manual**, and **0 V** for both Channel A and B.

Pos slope defines an event on the channel to be a rising edge. **Manual** mode instructs the HP 5372A to use the trigger level set by the Level entry, in this case, 0 volts. At 10 MHz, either **Manual** or **Sgl Auto** (Single Auto) mode will work.

The External Arm signal from the HP 3325B is 1 volt p-p. The preset value of 0 volts is adequate for the External Arm trigger level.

Below the trigger fields are setups for the input pods. They should read **GND** for Bias, **1:1** for attenuation, and **Min** for input hysteresis (Figure 9).

```

HP 5372A Frequency and Time Interval Analyzer

Phase Dev A:          0 deg  Manual Trig
_____

INPUT _____
Separate Input Channels  Single Auto Trig
Trigger Event:
Slope  Mode  Level
Chan A: Pos Manual 0 V      Repetitive
Chan B: Pos Manual 0 V      Auto Trig
Chan C: POS MANUAL 0 V
Ext Arm Level 0 V

Channel A  Channel B  Channel C
Input Pod  HP 54002A  HP 54002A  -----
Impedance  50 Ω      50 Ω      50 Ω
Bias Level  GND      GND      GND
Attenuation 1:1     1:1     0 %
Hysteresis  Min      Min      -----
Max Input   2 V peak  2 V peak  +20 dBm
  
```

Figure 9. INPUT menu configured for manually setting trigger levels.

Math Menu



5. Determining the Carrier Frequency

Press the **Math** hardkey (Figure 10).

```

HP 5372A Frequency and Time Interval Analyzer

Phase Dev A:          0 deg  Off
_____

MATH _____
Channel  Stats  Math  Limits  Carrier Freq  On
A      Off  Off  Off  Automatic
B      Off  Off  Off
C      Off  Off  Off  Phase Result  Set Ch A
                                     Modulo 360  Reference
Offset  Normalize  Scale
A  Disabled  Disabled  Disabled  Clear Ch A
B  Disabled  Disabled  Disabled  Reference
C  Disabled  Disabled  Disabled

Reference  Low Limit  High Limit
A  0E+00  Disabled  Disabled
B  0E+00  Disabled  Disabled
C  0E+00  Disabled  Disabled
  
```

Figure 10. MATH menu configuration after pressing Preset.

Move to the Carrier Frequency column so that **Automatic** is highlighted. Press the softkey **Compute Carrier Manual** to manually enter a carrier value. Move the highlight below manual and enter **10 M** using the arrow keys and softkey (Figure 11).

HP 5372A Frequency and Time Interval Analyzer

Phase Dev A: 0 deg

MATH

Channel	Stats	Math	Limits	Carrier Freq	
A	Off	Off	Off	Manual	
B	Off	Off	Off	10.00000E+00	Set Ch A Reference
C	Off	Off	Off	Phase Result	
				Modulo 360	
	Offset	Normalize	Scale		
A	Disabled	Disabled	Disabled		Clear Ch A Reference
B	Disabled	Disabled	Disabled		
C	Disabled	Disabled	Disabled		
	Reference	Low Limit	High Limit		
A	0E+00	Disabled	Disabled		
B	0E+00	Disabled	Disabled		
C	0E+00	Disabled	Disabled		

Figure 11. MATH Menu configured for manually setting carrier frequency.

The analyzer calculates the phase deviation from an ideal carrier. The MATH menu allows you to select whether the carrier frequency is automatically computed from the data, or manually entered.

When the carrier frequency is well known, it is best to choose "manual". A description of how the carrier is computed automatically in the HP 5372A can be found in the Appendix.

Phase Deviation results are either plotted in a cumulative fashion (they can exceed 360°) or are scaled by Modulo 360°. The choice is made in the MATH menu. For this example, leave the selection **Modulo 360**. (Either will work in this case since the phase change will not exceed 360°.)

Instrument State



6. Saving the Measurement Setup

This completes the measurement setup. To save this setup to the HP 5372A non-volatile storage memory, press **Save** and then **1**. If the HP 5372A CRT displays a message indicating that the register is write protected, press the **Inst State** key and either select a setup that is not write protected or turn off the write protection on register 1. Press **Save** and then **1** to save the setup. To recall this exact measurement setup, press **Recall** and then press **1** on the keypad.

Measurement Results

Graphic Results



Press **Restart** to acquire a new block of measurements.

Press the **Graphic** results hardkey.

If you pressed preset before setting up the HP 5372A, you will see a histogram display. A histogram of the results is not particularly useful for this measurement. With **MENU** set to **Main**, select a time variation graph by pressing the second softkey from the top until **Time Var** is highlighted. You are now viewing a plot of the PLL phase deviation versus time (Figure 12).

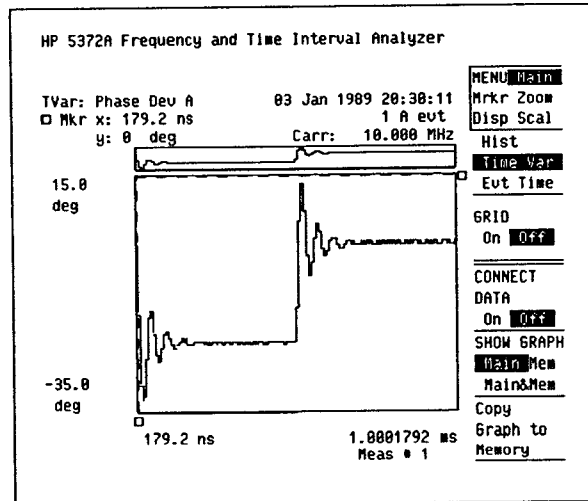

Figure 12. Time variation graph shows phase deviation versus time.

Notice the panorama graph at the top. This displays all of the data collected, and is useful when zooming in on a portion of the waveform. By observing the highlighted bar under the panorama graph, you can determine the position of the results on the display within the entire block of data.

Press the top-most softkey **MENU** five times to skim the menu options.

1. Using the HP 5372A Markers

The HP 5372A has two vertical and two horizontal markers. The vertical markers move along the time axis, the horizontal markers move along the phase axis. Only one marker can be moved at a time, but all four are visible on the display.

First you will use the vertical (↔) markers to measure the magnitude of the phase step. Highlight **Mrkr** by pressing the top softkey. The lower five softkeys now display the marker options, and by pressing the **--More--** softkey additional options are displayed. Rotate the knob to move the ↔ □ marker. As you scroll, notice that in the upper left corner, you can see the (x,y) values that correspond to the marker location.

Position the \leftrightarrow \square marker on the settled portion of the graph.

Activate the \leftrightarrow \bullet marker by pressing the softkey second from the top. The knob controls the movement of the active (highlighted) marker.

Position the \leftrightarrow \bullet marker on the lower part of the step.

2. Using Delta Marker Measurements

Locate the marker submenu that says Delta, then press it so that **Delta** is highlighted. Notice that the differences between the two markers are displayed in the upper left of the screen. The phase difference in this example is 20.9 degrees (Figure 13).

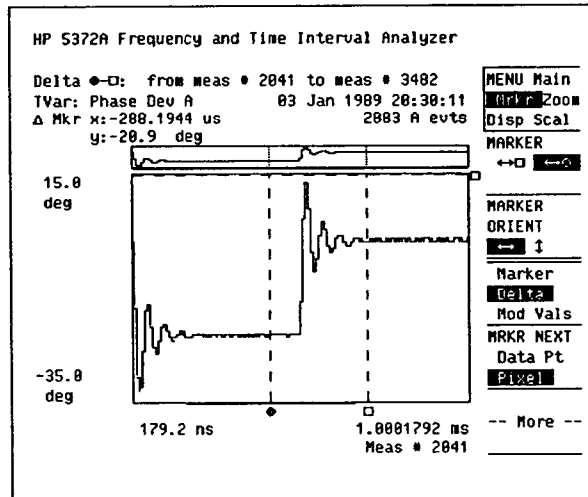

Figure 13. Using markers and delta feature to obtain the phase difference between two points.

Position the \leftrightarrow \bullet marker on the peak by pressing **Move** \leftrightarrow \bullet **Marker to Maximum**. You may have to press **--More--** to find the softkey.

Notice the delta function now displays a phase overshoot of 13 degrees in the upper left on the screen. (See Figure 14.)

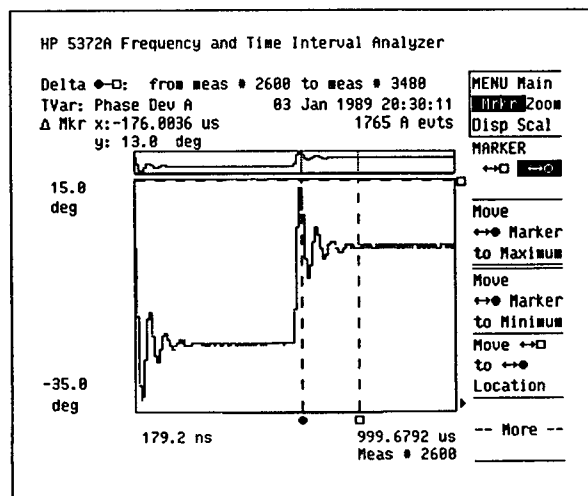

Figure 14. Using delta feature to measure phase overshoot.

3. Zooming in on the Display

By zooming you can see the phase overshoot and ringing of the PLL more closely.

Find the **Move** \leftrightarrow \square to \leftrightarrow \bullet **Location** and press it. This positions the \leftrightarrow markers on top of each other. Press the top softkey to highlight **Zoom**. Press **Zoom In Around** \leftrightarrow \bullet **Marker**.

Notice the highlighted bar under the panorama display indicating the portion of the waveform that you've zoomed in on.

Select **MARKER ORIENT** \updownarrow to activate the horizontal marker options. Position both horizontal (\updownarrow) markers on the flat part of the step (Figure 15).

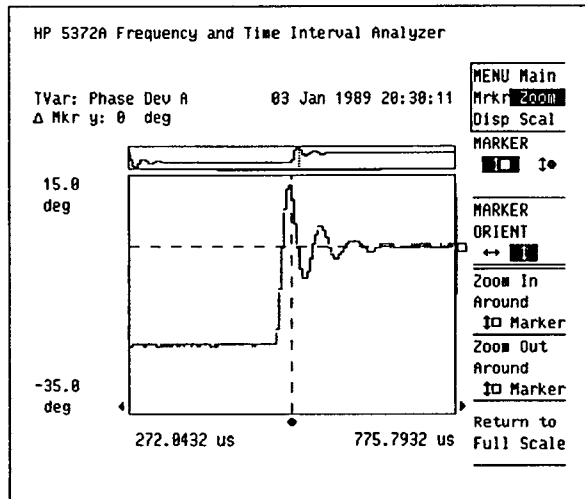

Figure 15. Position both horizontal markers on the stepped portion of the waveform.

Zoom in around the \updownarrow marker several times. This expands the display vertically (Figure 16).

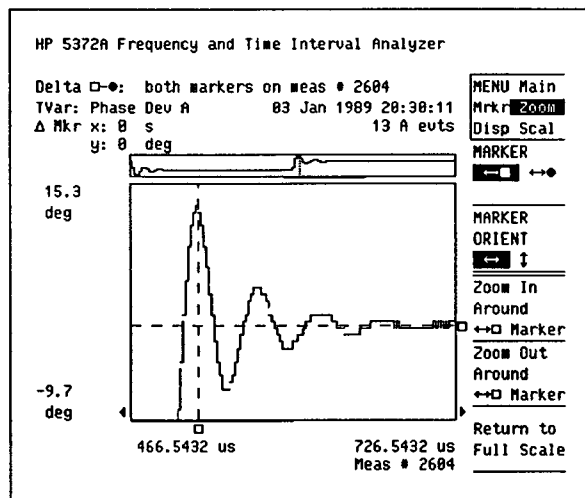

Figure 16. Use horizontal zooming to expand the time variation display vertically.

To bring the original graph back, you can zoom out or press **Return to Full Scale** with each marker orientation selected.

Using the markers, delta, and zoom features, you can also measure rise time and settling time parameters of the loop. (See Figures 17 and 18.)

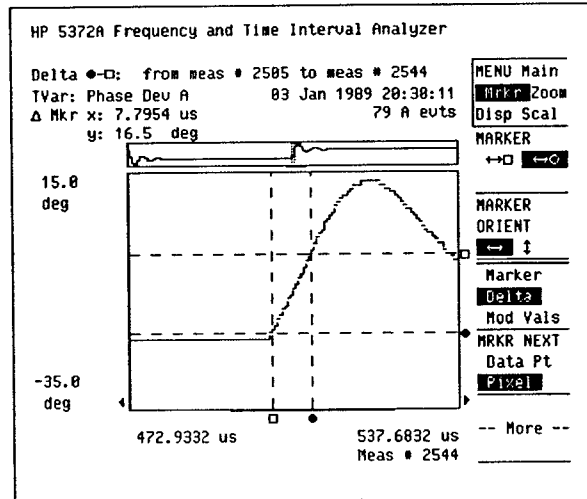

Figure 17. Using markers, delta and zoom features to measure rise time.

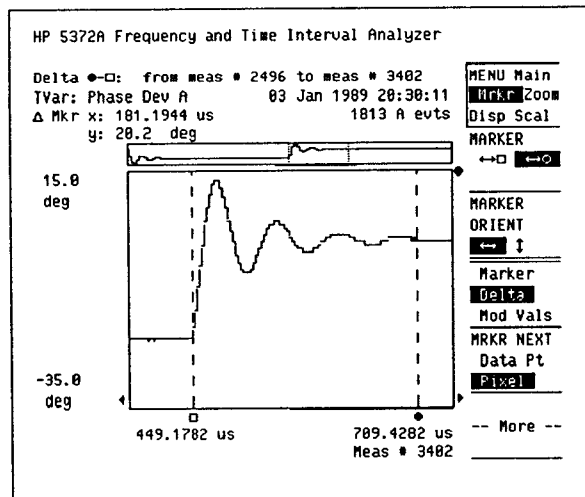

Figure 18. Using markers, delta and zoom features to measure settling time.

4. Using Built-In Modulation Analysis

Select **Mrkr** options, and position the \leftrightarrow markers around the step. These markers are used to bound the region on the display for modulation analysis.

Next, use the modulation analysis feature to compute the natural ringing frequency.

Highlight **Mod Vals** found in the **Mrkr** submenu. At the top of the screen modulation parameters such as deviation, rate, and center frequency are displayed (Figure 19). When measuring ringing as in this application, only the rate is meaningful. (You may see the message **Rate: not computable***. In this case, reposition the markers until a rate is computed.)

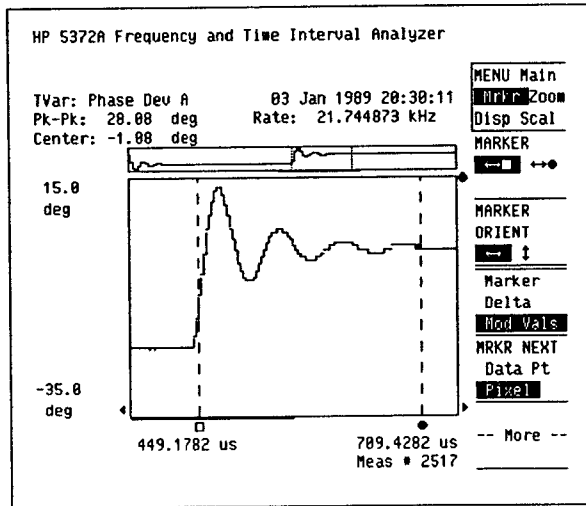

Figure 19. Using the modulation analysis feature to display undamped natural frequency.

Modulation Rate is estimated by curve fitting the data between the vertical markers.

You may want to check the input signal by going through this procedure with the input of the PLL connected to channel B of the analyzer. You can see in Figure 20 that the input signal in this example steps to its final phase in less than 200 ns.

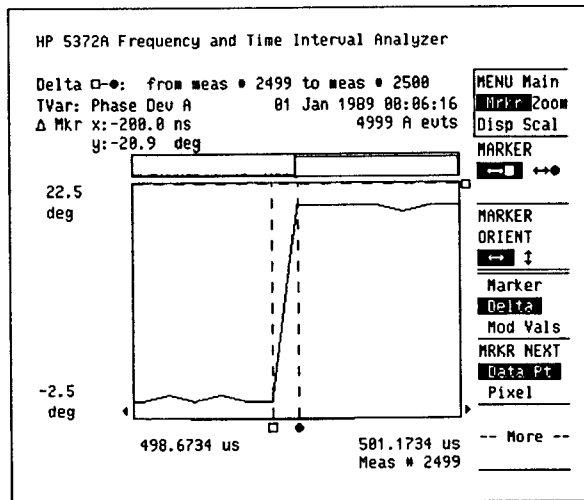

Figure 20. Measuring phase deviation on Channel B verifies input signal phase step changes in less than 200 ns.

* **Rate: not computable** appears when the modulation on the portion of the waveform bounded by the vertical markers does not exhibit periodic behavior.

HP 5372A Advantages

-
- Phase-locked loop step-response can be viewed directly as phase deviation from a reference that is manually entered or automatically computed in the HP 5372A.
 - The HP 5372A's deep measurement memory captures all of the PLL's settling characteristics.
 - Markers and zooming features on the graphic display can be used to accurately measure PLL transient parameters such as settling time, overshoot, and rise time.
 - Built-in modulation analysis computes PLL undamped natural frequency.
 - The analyzer's precision timing translates into high resolution phase measurements.

For Further Information

For more information on the HP 5372A Frequency and Time Interval Analyzer and the techniques described in this application note, please refer to the following publications:

HP 5372A Data Sheet/Brochure (5952-7997)

HP 5372A "Condensed Reference and Specification Guide"
(5952-8012)

Application Note 358-4, "Pre-Trigger Simplifies VCO Step Response Measurements" (5952-7998)

Application Note 358-8, "Single-shot BPSK Signal Characterization" (5952-8002)

Application Note 358-10, "Characterizing Barker Coded Modulation in Radar Systems" (5952-8004)

HP 5372A Getting Started Guide (5952-8009)

Appendix

How phase deviation is computed in the HP 5372A.

The HP 5372A functions like an instantaneous phase digitizer. At user-specified sampling intervals, the HP 5372A detects the instantaneous phase of a signal relative to a starting phase. It does this by totalizing the number of events (or slope sensitive level-crossings), each of which represents a phase addition of 2π , and recording the exact time at which the totalize measurement is made. By saving the changing phase information in internal memory, the HP 5372A effectively captures the phase changes on a carrier.

Plotting these events as a function of time, and scaling them by 2π reveals a phase progression plot (cumulative phase versus time). A constant unmodulated carrier results in a straight line of positive slope equal to its frequency as shown in Figure A. (Frequency is the derivative of phase.)

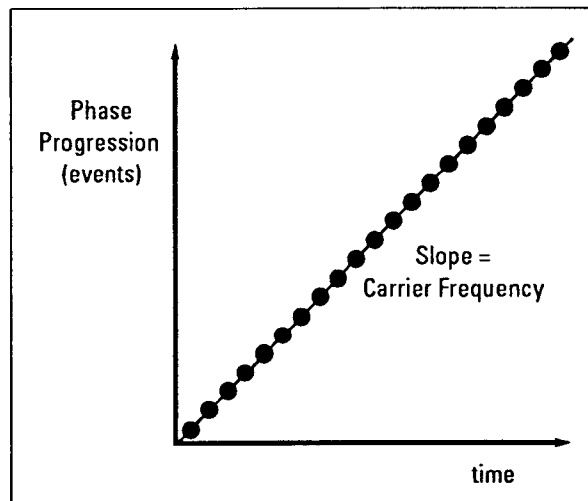

Figure A. Phase progression plot of unmodulated carrier.

Phase modulation is measured as the phase deviation of the signal from the constant carrier or deviation from the straight line as shown in Figures B and C.

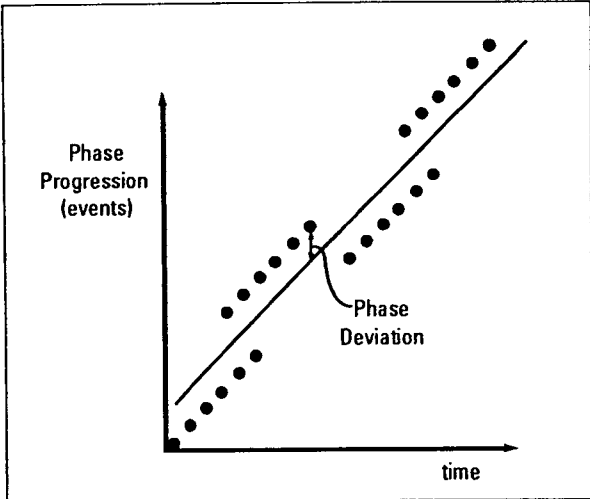

Figure B. Phase progression plot of phase modulated carrier.

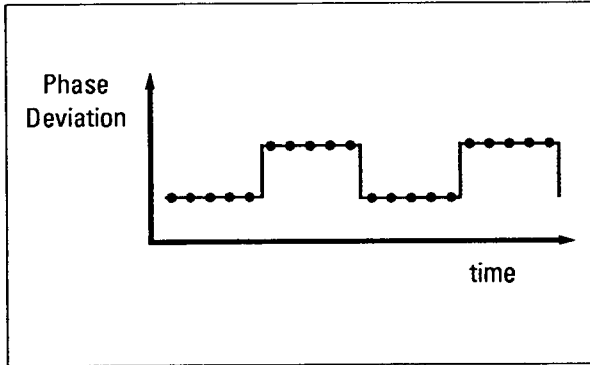

Figure C. Phase deviation plot shows phase modulation.

How the carrier is computed automatically in the HP 5372A.

When Automatic carrier is selected, the expected frequency (slope) is estimated by the HP 5372A from the input signal. The estimation method is called the bi-centroid mean. (See Figure D.) It is close in precision to a least squares fit, and significantly faster to perform.

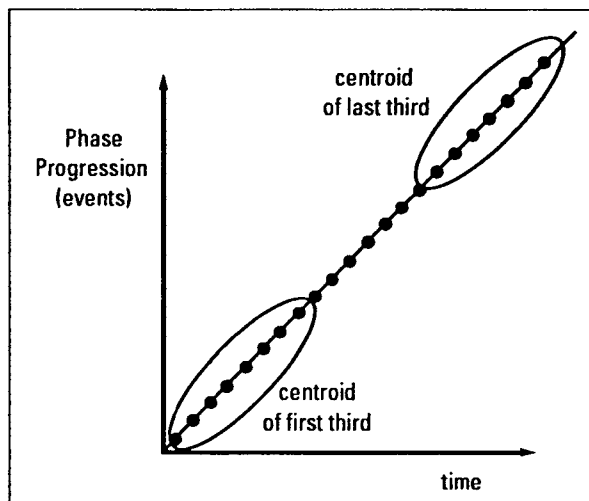

Figure D. Carrier frequency is automatically computed using a bi-centroid mean.

In the case of the example used in this note, the carrier will not be computed correctly unless the phase modulation on the signal is exactly symmetrical. If the carrier is not the correct frequency, a phase deviation plot that looks crooked (has a constant slope) will result. (See Figure E.)

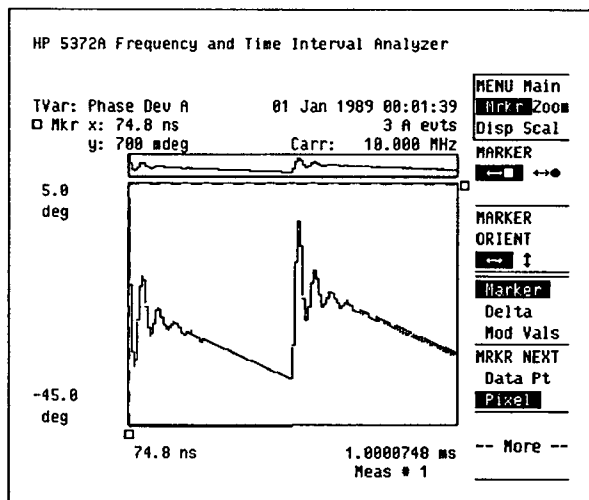

Figure E. Incorrect carrier results in a crooked phase deviation plot.

When measuring square wave phase modulated signals, it is generally better to manually enter the carrier because it is difficult to obtain exactly symmetrical modulation.

For more information, call you local HP sales office listed in your telephone directory or an HP regional office listed below for the location of your nearest sales office.

United States:

Hewlett-Packard Company
4 Choke Cherry Road
Rockville, MD 20850
(301) 670-4300

Hewlett-Packard Company
5201 Tollview Drive
Rolling Meadows, IL 60008
(312) 255-9800

Hewlett-Packard Company
5261 Lankershim Blvd.
No. Hollywood, CA 91601
(818) 505-5600

Hewlett-Packard Company
2015 South Park Place
Atlanta, GA 30339
(404) 955-1500

Canada:

Hewlett-Packard Ltd.
6877 Goreway Drive
Mississauga, Ontario L4V 1MB
(416) 678-9430

Japan:

Yokogawa-Hewlett-Packard Ltd.
15-7, Nishi Shinjuku 4 Chome
Shinjuku-ku
Tokyo 160, Japan
(03) 5371 1351

Latin America:

Hewlett-Packard
Latin American Region Headquarters
Monte Pelvoux No. 111
Lomas de Chapultepec
11000 Mexico, D.F. Mexico
(525) 202-0155

Australia/New Zealand:

Hewlett-Packard Australia Ltd.
31-41 Joseph Street
Blackburn, Victoria 3130
Melbourne, Australia
(03) 895-2895

Far East:

Hewlett-Packard Asia Ltd.
22/F Bond Centre
West Tower
89 Queensway
Central, Hong Kong
(5) 8487777

In Europe, please call your local HP sales office or representative:

Austria, COMECON-countries and Yugoslavia:
(0222) 2500 0

Belgium and Luxembourg:
(02) 761 31 11

Denmark:
(02) 81 66 40

Finland:
(0) 88 721

France:
(1) 60 77 42 52

Germany:
(06172) 400 0

Greece:
(01) 68 28 11

Iceland:
(01) 671 000

Ireland:
(01) 88 33 99

Italy:
(02) 92 36 91

Netherlands:
(020) 547 6669

Norway:
(02) 24 60 90

Spain:
900 123 123

Sweden:
(08) 750 20 00

Switzerland:
(057) 31 21 11 (Head Office)
(022) 780 41 11 (Suisse Romande)
(046) 05 15 05 (Customer Information Center)

U.K.:
(0734) 777 828

Middle East and Africa:
Geneva-Switzerland
41/22 780 7111

European Headquarters
Hewlett-Packard S.A.
150, Route du Nant d'Avril
1217 Meyrin 2
Geneva--Switzerland
41/22 780 8111

Prices and Data Subject to Change
October, 1989

Copyright © 1989
Hewlett-Packard Co.
Printed in U.S.A.
5952-8001