

## Errata

**Document Title:** Optimizing the Dynamic Range of the 3585A Spectrum Analyzer  
(AN 246-1)

**Part Number:** 5952-8815

**Revision Date:** October 1987

---

### HP References in this Application Note

This application note may contain references to HP or Hewlett-Packard. Please note that Hewlett-Packard's former test and measurement, semiconductor products and chemical analysis businesses are now part of Agilent Technologies. We have made no changes to this application note copy. The HP XXXX referred to in this document is now the Agilent XXXX. For example, model number HP8648A is now model number Agilent 8648A.

### About this Application Note

We've added this application note to the Agilent website in an effort to help you support your product. This manual provides the best information we could find. It may be incomplete or contain dated information, and the scan quality may not be ideal. If we find a better copy in the future, we will add it to the Agilent website.

### Support for Your Product

Agilent no longer sells or supports this product. You will find any other available product information on the Agilent website:

[www.agilent.com](http://www.agilent.com)

Search for the model number of this product, and the resulting product page will guide you to any available information. Our service centers may be able to perform calibration if no repair parts are needed, but no other support from Agilent is available.

# I. Introduction

The primary purpose of a spectrum analyzer is to identify and measure electrical signals in the frequency domain. The CRT display with a linear frequency scale and a log amplitude scale has proven to be very convenient for a direct view of signals with wide frequency and amplitude differences. The maximum amplitude difference which can be measured between two signals is described by the specification called dynamic range. The purpose of this application note is to describe dynamic range in general and illustrate how to optimize the dynamic range of the HP 3585A Spectrum Analyzer for different measurement conditions. Since the HP 3585A is a swept heterodyne analyzer, the description will be limited to analyzers of that type. (Figure 1)

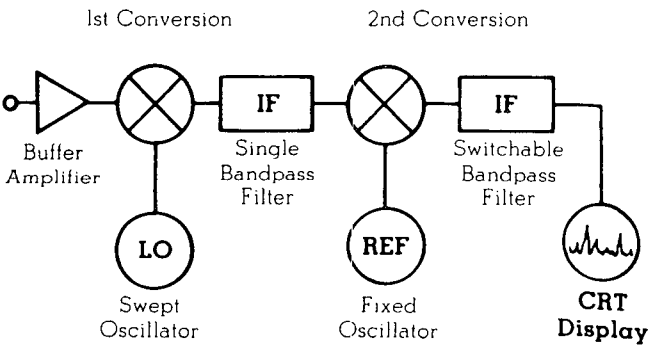

**Block diagram of double conversion swept heterodyne spectrum analyzer.**

**Figure 1**

To be more specific, dynamic range is the ratio expressed in dB of the largest and smallest signal levels which can be measured while simultaneously present at the input. With a large signal at "full scale" the measurement of small signals is limited by a combination of internally generated noise, harmonic distortion and spurious responses. In the case of two large signals (each less than or equal to 6 dB below "full scale"), the additional limit of internally generated intermodulation distortion must be applied. What does "full scale" mean? This is the input level which yields a reasonable compromise between internal noise limits and internal distortion limits. The compromise exists because the noise and distortion limits move in opposite directions as the input level is varied (Figure 2). The reason for this will be explained in the next section.

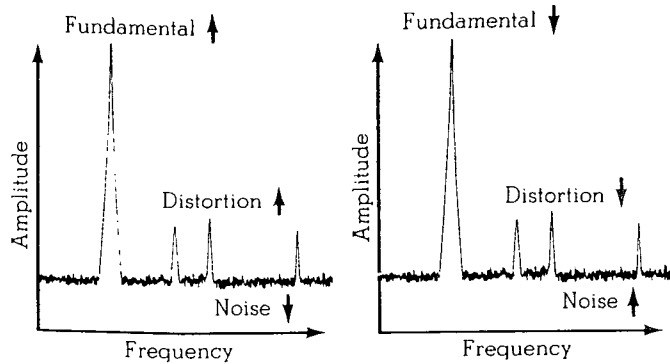

**Relationship of input level to internal noise and distortion.**

**Figure 2**

The point is, the user need not always accept this compromise for every measurement. In most situations, a tradeoff can be made between noise and distortion which can improve dynamic range by at least 10 dB. The HP 3585A is especially suited for optimizing dynamic range because of the precision synthesized tuning and the narrow 3 Hz resolution bandwidth. These two features make it easy to tune to a signal while keeping the analyzer noise as low as possible.

## II. The Limits of Dynamic Range

Before learning the procedures for improving dynamic range, it is helpful to understand what internal processes cause the limitations. A little understanding goes a long way in helping to remember the correct procedure for a particular measurement.

Referring to Figure 1 again, it can be reasoned that the input attenuator should have no inherent effect on dynamic range since it affects both large and small signals equally. However, given a fixed external signal, the input attenuator can be used to adjust the level at the input mixer which does affect the dynamic range.

The full scale signal which can then be applied to the input mixer depends on how much compression and how much distortion is acceptable. Compression is the amplitude error due to large signal nonlinearities in the mixer. Distortion generated internally consists of both harmonic and intermodulation products. As the signal level at the mixer increases, both the compression and distortion increase. However, compression error is small in dB compared to the increase in distortion created in the mixer at large signal levels. In fact, for the HP 3585A, the compression error is essentially unmeasurable for any signal displayed on screen.

Figure 3 shows the typical relationship of signal level versus both internal harmonic distortion and intermodulation distortion. Notice that the higher order products increase at a faster rate than the fundamental level. This information is useful for determining the origin of suspicious signals by measuring the level

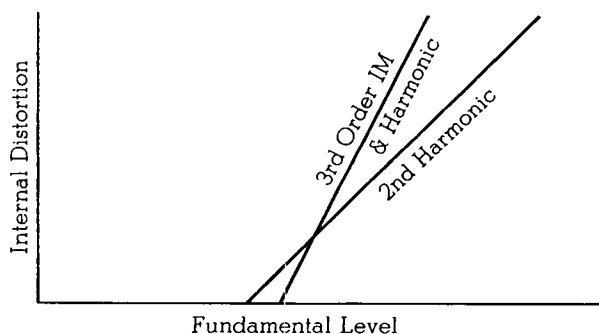

**Relative slope of 2nd and 3rd order products.**

**Figure 3**

change when the fundamental signal changes. For example, second order products change approximately 5 dB relative to the fundamental for each 5 dB change of the fundamental and third order products change by 10 dB for each 5 dB change. Since the relative change is slightly different from analyzer to analyzer, best performance can be obtained by individually characterizing each analyzer.

From the standpoint of distortion, it appears that the lower the mixer level the better. Unfortunately, internal noise forms an absolute floor which is not a function of the level at the input mixer. In addition, there are usually residual responses which are not related to the input signal but result from mixing processes internal to the analyzer. At the point where distortion products are equal to either the noise or residual responses, reducing the level at the mixer will no longer increase total dynamic range. Generally, the noise floor will be the first limit. However, since the displayed noise is a function of the resolution bandwidth, it can be progressively lowered by using narrower bandwidths. For the HP 3585A, the noise floor will be lower than the residual response specification,  $-95$  dB, for bandwidths of 100 Hz or less.

To obtain maximum dynamic range for all measurement conditions, you can see that it is a matter of optimizing the mixer input level and the resolution bandwidth against the residual responses. To summarize the effects of changing mixer level and resolution bandwidth with respect to the fundamental signal, refer to Figure 4.

### III. Reducing Analyzer Noise

For measurements where external low-level spurious responses are obscured by the displayed noise of the HP 3585A, there are three steps that can be taken to reduce the noise. First, the resolution bandwidth can be reduced from that chosen by the automatic coupling process. This is done by pressing **RES BW** and then  $\nabla$  several times until the noise is at the desired level. The tradeoff is that the sweep speed becomes considerably slower for the same frequency span. The rate of sweep for gaussian filters ( $BW^2/2$ ) is a characteristic of all swept analyzers using gaussian filters in the IF section. To illustrate both the reduction of internal noise and the increased sweep time, see Figure 5 and the accompanying chart where the resolution bandwidth has been successively changed over a single sweep.

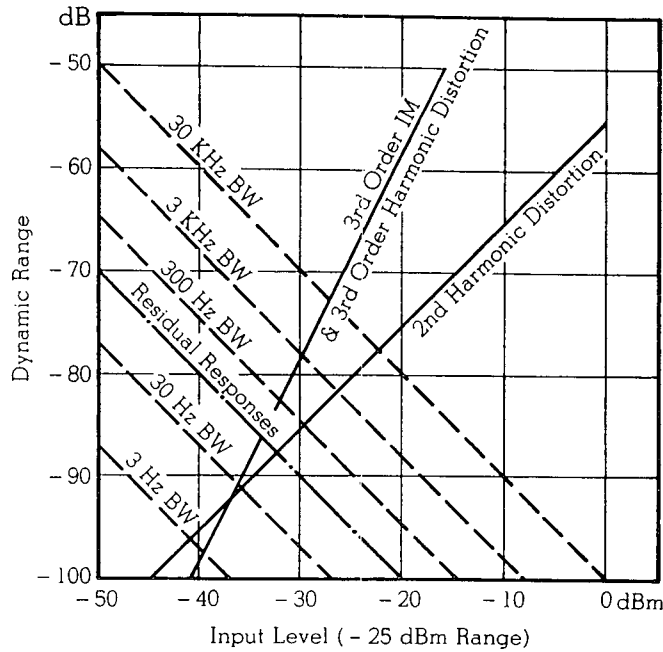

**Determining factors of dynamic range.**

**Figure 4**

The autoranging input attenuator sets the level to the input mixer of the HP 3585A automatically to provide a total dynamic range of 80 dB. In the wider spans (thus wider resolution bandwidths), the noise level predominates while in the narrower spans the distortion level is the main limit.

The automatic functions can be easily changed to optimize the dynamic range for a given measurement situation. For example, if you want to measure the signal/noise ratio of an amplifier, then the mixer level can be increased to effectively lower the analyzer noise floor because internally generated analyzer distortion is not of concern in this case. On the other hand, if harmonic distortion is to be measured, then a lower mixer level and a narrow resolution bandwidth with a narrow span can be used since harmonics occur at known frequencies which can be easily located with the precise tuning of the HP 3585A. Even residual responses can be identified and eliminated as sources of error since they occur at fixed frequencies and levels which are unrelated to the input signal. The next two sections will show you specifically how to optimize the dynamic range of the HP 3585A and what typical performance can be expected for different measurement situations.

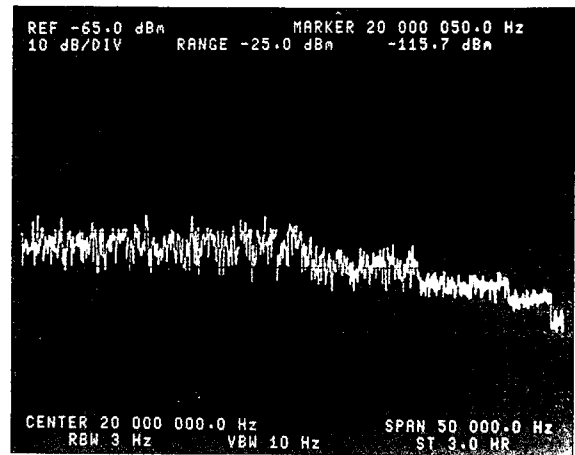

Horizontal Divisions	Res BW	Sweep Speed
1-5	300 Hz	45 KHz/sec
6-7	100 Hz	5 KHz/sec
8-9	30 Hz	450 Hz/sec
9-9.7	10 Hz	50 Hz/sec
9.7-10	3 Hz	4.5 Hz/sec

**Effects of reducing resolution bandwidth.**

**Figure 5**

The display can be further enhanced when searching for low-level discrete signals by reducing the video bandwidth below that automatically selected. Video bandwidth is determined by a low pass filter circuit which reduces the fluctuations of a noisy DC signal produced by the detector circuit.

Although this technique does not lower the average internal noise level, it does reduce the magnitude of the fluctuations of the noise about the average. Discrete signals which might otherwise be masked by noise fluctuations will then show above the average noise level. Again, the tradeoff is in speed since additional settling time is required. Figure 6 is an example of the effect of reducing the video bandwidth to one percent of the resolution bandwidth. Generally, reductions to less than one percent will yield marginal improvements.

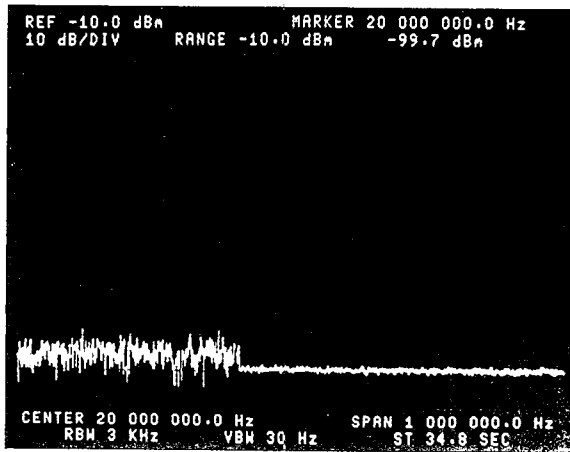

Reduction of noise by decreasing the video bandwidth.

Figure 6

The third technique for further reduction of noise applies when accurate distortion measurements are not required. The input range can be reduced by 5 or 10 dB with a corresponding improvement in signal to noise ratio. The overload light will be on but it only indicates that distortion specifications may not be met. The  $\frac{+}{-}$  function should be turned off first if you want to keep the fundamental signal at the top of screen. Up to 12.3 dB of overdrive is possible without compression of the fundamental signal. This is equivalent to a  $-12.7$  dBm signal on the  $-25$  dBm range. In narrow spans, (resolution bandwidth  $< 1$  KHz) the noise floor will drop below the bottom of the screen; the reference level can then be stepped down until the noise floor reappears. This does not affect the overdrive measurement. Figure 7 shows the before and after traces for a range change from  $-5$  dBm to  $-15$  dBm. Remember that harmonic and intermodu-

lation distortion will be greatly increased with this method and cannot be measured accurately. An unknown signal near the noise level can be checked easily to see if it is due to distortion by observing its level while down-ranging the input. If the signal level increases, then it is due to internal distortion; however, if the signal level remains approximately constant then it is due to an external source.

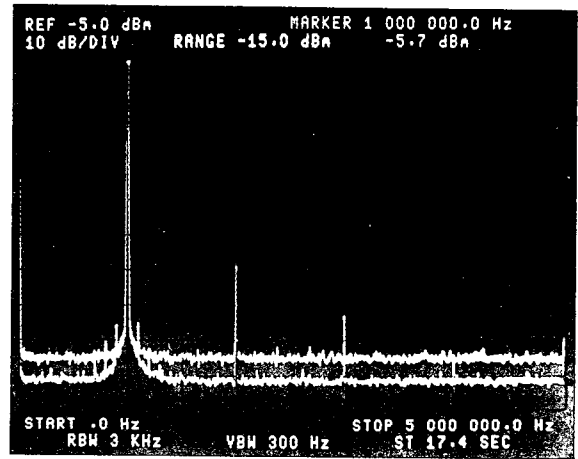

Reduction of noise by downranging the input.

Figure 7

## IV. Reducing Analyzer Distortion

Measurements of low level distortion products can be enhanced by ranging the input to a higher range. Upranging by 5 or 10 dB will reduce the fundamental signal level at the input mixer and consequently reduce both harmonic and intermodulation distortion that is generated internally. Obviously the tradeoff is a decrease in signal to noise ratio.

The overall distortion specification of 80 dB can be improved typically to 95 dB, by pressing the **RANGE** key and the  $\uparrow$  key once for 5 dB or twice for 10 dB uprange. To keep the display onscreen, turn the  $\square$  key off before upranging. It will be necessary to use a narrow span and a resolution bandwidth of 100 Hz or less to keep the noise floor below the distortion products. Some video filtering may also be necessary for very low level measurements.

One way to circumvent the long sweep time associated with narrow bandwidths is to use the manual sweep mode of the HP 3585A which provides a continuously updated reading at a single frequency. To implement this type of measurement, complete a sweep using the normal bandwidths to locate the signal; then set the marker on the peak of the signal, press **MANUAL**, and reduce the resolution bandwidth and video bandwidth until a stable reading is achieved. The peak can be verified by tuning the frequency up and down slightly for a maximum reading.

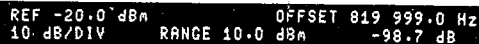

REF -20.0 dBm      OFFSET 819 999.0 Hz  
10. dB/DIV      RANGE 10.0 dBm      -98.7 dB

## V. Frequency Response Measurements

A dynamic range of more than 120 dB can be achieved when using the internal Tracking Generator to measure the frequency response of linear networks. Figure 9 shows the swept response of a 400 KHz band-pass using a full scale range of +5 dBm. The marker has been set to the top of the filter and the offset mode activated to set a reference. In Figure 10, the range has been set to -25 dBm which is a full 30 dB over-range. The top of the filter can no longer be seen but the stopband with 110 dB rejection is clearly more visible. Without reducing the span, the marker was moved to the lowest point, the Manual mode activated, and the narrowest bandwidth used to show an actual rejection of 126.8 dB. The analyzer noise floor is still almost 10 dB below this reading. The total filter response can be seen in Figure 11 which was made up by overlapping Figures 9 and 10. The distortion generated by overdrive in this case is not a problem because the analyzer always tracks the fundamental of the tracking generator and thus never sees the distortion products.

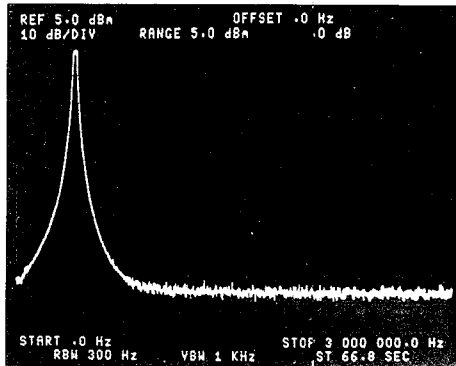

Normal input range.

Figure 9

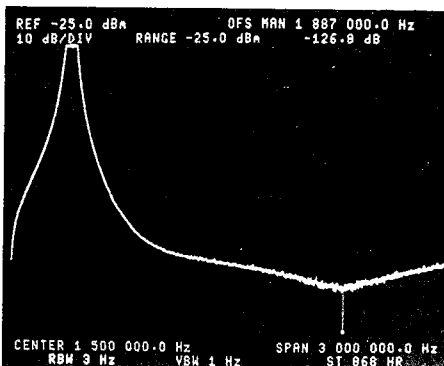

30 dB overdrive.

Figure 10

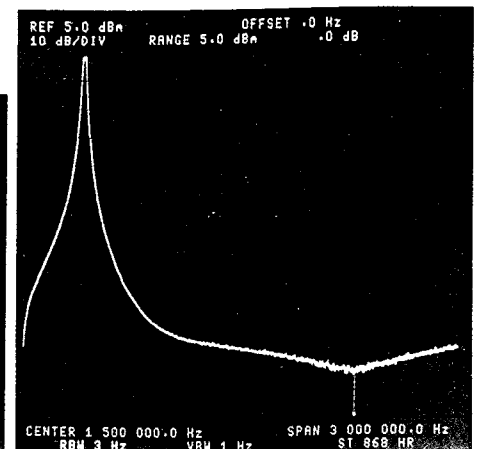

Composite picture.

Figure 11

## VI. Summary

With these techniques, the typical performance that can be achieved with the HP 3585A is 95 dB for distortion measurements, 120 dB for signal to noise ratio (referred to a 1 Hz BW), and 120 dB for network amplitude response.

The measurement techniques presented here are basic to any swept spectrum analyzer, but the features of the HP 3585A such as synthesized tuning, 3 Hz resolution bandwidth and digitally stored traces make these measurements easier to make than with conventional analyzers. Once you become familiar with the Manual sweep mode, the measurements are faster as well as easier. As with many sophisticated instruments, the performance can be enhanced by the astute user.

**USA:** Hewlett-Packard Co., P.O. Box 10301, Palo Alto, California 94303-0890 • **Europe:** Hewlett-Packard Co., P.O. Box 999, 1180 AZ Amstelveen, The Netherlands • **Far East:** Hewlett-Packard Asia Headquarters, 47/F China Resources Building, 2e Harbour Road, Wanchai, Hong Kong • **Australasia:** Hewlett-Packard Australia Ltd., 31-41 Joseph Street, Blackburn, Victoria 3130, Australia • **Canada:** Hewlett-Packard Canada Ltd., c877 Goreway Drive, Mississauga, Ontario, Canada L4V 1M8 • **Japan:** Yokogawa Hewlett-Packard Ltd., 29-21 Takaido-Higashi, 3 Chome, Suginami-Ku, Tokyo 168, Japan • **Latin America:** Hewlett-Packard Latin America Headquarters, 3495 Deer Creek Rd., Palo Alto, CA 94304. **For all other areas, please write to:** Hewlett-Packard Intercontinental Headquarters, 3495 Deer Creek Rd., Palo Alto, CA 94304