

Optical Spectrum Analysis

Application Note 1550-4

Optical Spectrum Analysis Basics

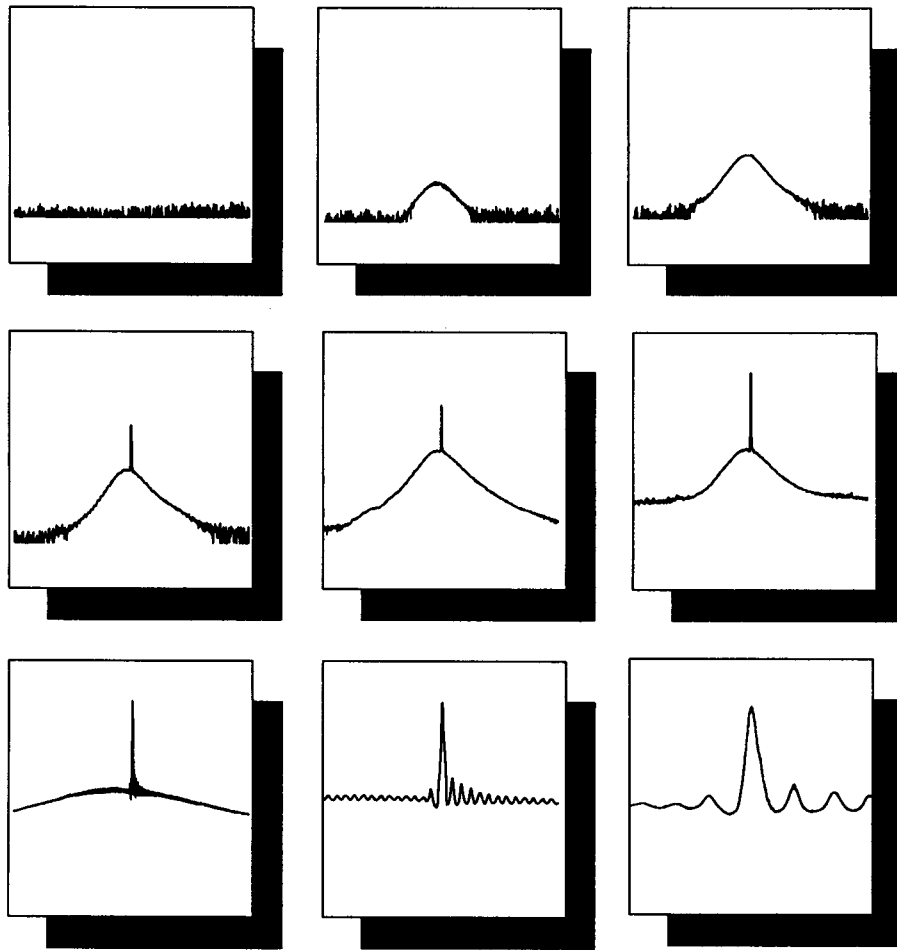

Agilent Technologies

Innovating the HP Way

Table of Contents

	Page
Introduction	3
Chapter 1	
Types of optical spectrum analyzers	4
Interferometer-Based Optical Spectrum Analyzers	5
Diffraction-Grating-Based Optical Spectrum Analyzers	6
Chapter 2	
Diffraction-grating-based optical spectrum analyzers	12
Wavelength Tuning and Repeatability	12
Wavelength Resolution Bandwidth	12
Dynamic Range	13
Sensitivity	14
Tuning Speed	15
Polarization Insensitivity	17
Input Coupling	19
Appendix	
Optical and microwave spectrum analyzers compared	20

Introduction

This application note is intended to provide the reader with a basic understanding of optical spectrum analyzers, their technologies, specifications, and applications. Chapter 1 describes interferometer-based and diffraction-grating-based optical spectrum analyzers. Chapter 2 defines many of the specified performance parameters of diffraction-grating-based optical spectrum analyzers and discusses the relative merits of the single monochromator, double monochromator, and double-pass-monochromator-based optical spectrum analyzers. For readers familiar with electrical spectrum analyzers, some of the same terms are used, but with different definitions.

Optical spectrum analysis

Optical spectrum analysis is the measurement of optical power as a function of wavelength. Applications include testing laser and LED light sources for spectral purity and power distribution, as well as testing transmission characteristics of optical devices.

The spectral width of a light source is an important parameter in fiber-optic communication systems due to chromatic dispersion, which occurs in the fiber and limits the modulation bandwidth of the system. The effect of chromatic dispersion can be seen in the time domain as pulse broadening of a digital waveform. Since chromatic dispersion is a function of the spectral width of the light source, narrow spectral widths are desirable for high-speed communication systems.

Figure 1 shows the spectrum of a Fabry-Perot laser. The laser is not purely monochromatic; it consists of a series of evenly spaced coherent spectral lines with an amplitude profile determined by the characteristics of the gain media.

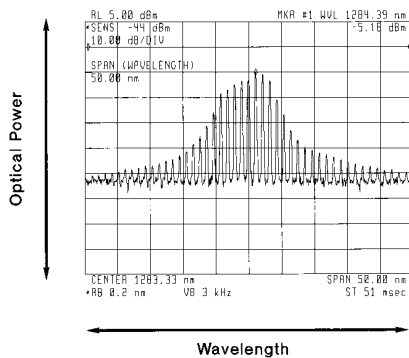

Figure 1. Optical spectrum analyzer measurement of a Fabry-Perot laser.

Optical spectrum analyzers can be divided into three categories: diffraction-grating-based and two interferometer-based architectures, the Fabry-Perot and Michelson interferometer-based optical spectrum analyzers. Diffraction-grating-based optical spectrum analyzers are capable of measuring spectra of lasers and LEDs. The resolution of these instruments is variable, typically ranging from 0.1 nm to 5 or 10 nm. Fabry-Perot-interferometer-based optical spectrum analyzers have a fixed, narrow resolution, typically specified in frequency, between 100 MHz and 10 GHz. This narrow resolution allows them to be used for measuring laser chirp, but can limit their measurement spans much more than the diffraction-grating-based optical spectrum analyzers. Michelson interferometer-based optical spectrum analyzers, used for direct coherence-length measurements, display the spectrum by calculating the Fourier transform of a measured interference pattern.

Chapter I

Types of optical spectrum analyzers

Basic block diagram

A simplified optical spectrum analyzer block diagram is shown in figure 2. The incoming light passes through a wavelength-tunable optical filter (monochromator or interferometer) which resolves the individual spectral components. The photodetector then converts the optical signal to an electrical current proportional to the incident optical power. An exception to this description is the Michelson interferometer, which is not actually an optical filter.

The current from the photodetector is converted to a voltage by the transimpedance amplifier and then digitized. Any remaining signal processing, such as applying correction factors, is performed digitally. The signal is then applied to the display as the vertical, or amplitude, data. A ramp generator determines the horizontal location of the trace as it sweeps from left to right. The ramp also tunes the optical filter so that its resonant wavelength is proportional to the horizontal position. A trace of optical power versus wavelength results. The displayed width of each mode of the laser is a function of the spectral resolution of the wavelength-tunable optical filter.

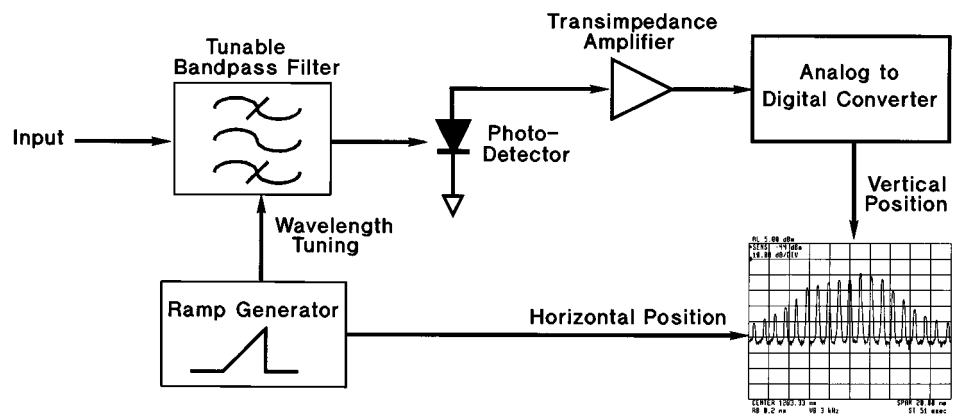

Figure 2. Simplified optical spectrum analyzer block diagram.

Interferometer-based optical spectrum analyzers

Fabry-Perot interferometers

The Fabry-Perot interferometer, shown in figure 3, consists of two highly reflective, parallel mirrors that act as a resonant cavity which filters the incoming light. The resolution of Fabry-Perot interferometer-based optical spectrum analyzers, dependent on the reflection coefficient of the mirrors and their spacing, is typically fixed, and the wavelength is varied by changing the spacing between the mirrors by a very small amount.

The advantage of the Fabry-Perot interferometer is its very narrow spectral resolution, which allows it to measure laser chirp. The major disadvantage is that at any one position multiple wavelengths will be passed by the filter. (The spacing between these responses is called the free spectral range.) This problem can be solved by placing a monochromator in cascade with the Fabry-Perot interferometer to filter out all power outside the interferometer's free spectral range about the wavelength of interest.

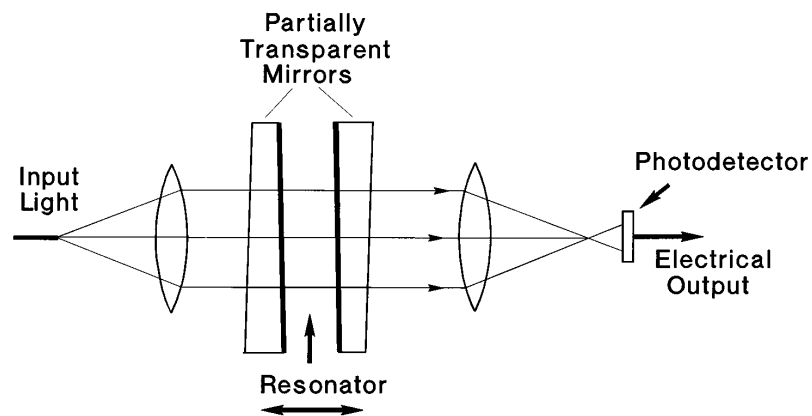

Figure 3. Fabry-Perot-interferometer-based optical spectrum analyzer.

Michelson interferometers

The Michelson interferometer, shown in figure 4, is based on creating an interference pattern between the signal and a delayed version of itself. The power of this interference pattern is measured for a range of delay values. The resulting waveform is the autocorrelation function of the input signal. This enables the Michelson interferometer-based spectrum analyzer to make direct measurements of coherence length, as well as very accurate wavelength measurements. Other types of optical spectrum analyzers cannot make direct coherence-length measurements.

To determine the power spectra of the input signal, a Fourier transform is performed on the autocorrelation waveform. Because no real filtering occurs, Michelson interferometer-based optical spectrum analyzers cannot be put in a span of zero nanometers, which would be useful for viewing the power at a given wavelength as a function of time. This type of analyzer also tends to have less dynamic range than diffraction-grating-based optical spectrum analyzers.

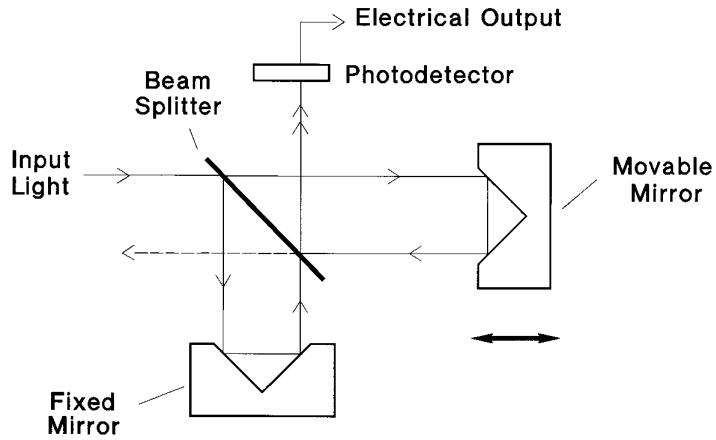

Figure 4.
Michelson-interferometer-based optical spectrum analyzer.

Diffraction-grating-based optical spectrum analyzers

The most common optical spectrum analyzers use monochromators as the tunable optical filter. In the monochromator, a diffraction grating (a mirror with finely spaced corrugated lines on the surface) separates the different wavelengths of light. The result is similar to that achieved with a prism. Figure 5 shows what a prism-based optical spectrum analyzer might look like. The prism separates the different wavelengths of light, and only the wavelength that passes through the aperture reaches the photodetector. The angle of the prism determines the wavelength to which the optical spectrum analyzer is tuned, and the size of the aperture determines the wavelength resolution.

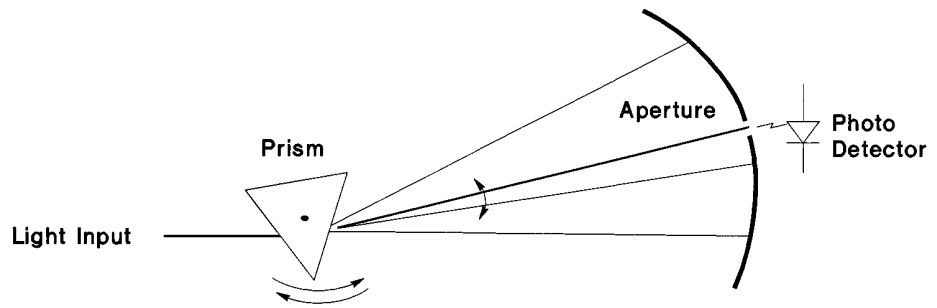

Figure 5.
Concept of prism-based optical spectrum analyzer. Diffraction gratings are used instead of prisms because diffraction gratings provide greater separation among wavelengths of light.

Diffraction gratings are used instead of prisms because they provide a greater separation of wavelengths, with less attenuation. This allows for better wavelength resolution.

A diffraction grating is a mirror with grooves on its surface, as shown in figure 6. The spacing between grooves is extremely narrow, approximately equal to the wavelengths of interest. When a parallel light beam strikes the diffraction grating, the light is reflected in a number of directions.

The first reflection is called the zero-order beam ($m=0$), and it reflects in the same direction as it would if the diffraction grating were replaced by a plane mirror. This beam is not separated into different wavelengths and is not used by the optical spectrum analyzer.

The first-order beam ($m=1$) is created by the constructive interference of reflections off each groove. For constructive interference to occur, the path-length difference between reflections from adjacent grooves, must equal one wavelength. If the input light contains more than one wavelength component, the beam will have some angular dispersion; that is, the reflection angle for each wavelength must be different in order to satisfy the requirement that the path-length difference off adjacent grooves is equal to one wavelength. Thus, the optical spectrum analyzer separates different wavelengths of light.

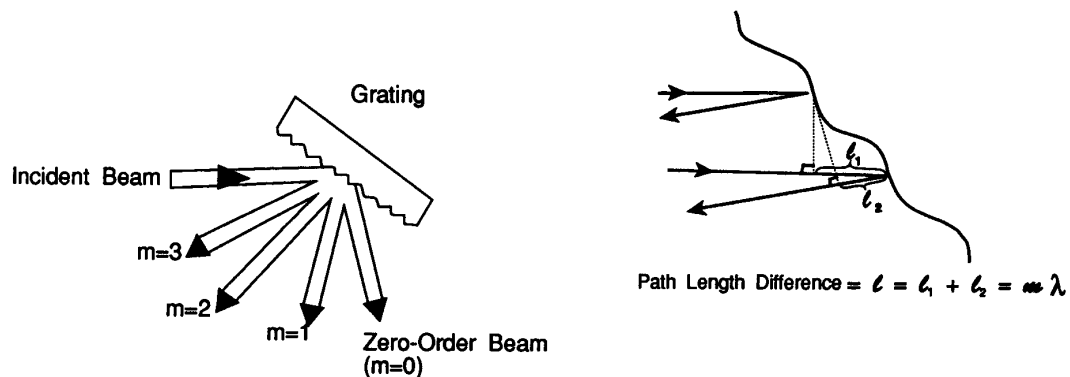

Figure 6.
The diffraction grating separates the input beam into a number of output beams. Within each output beam, except the zero order beam, different wavelengths are separated.

For the second-order beam ($m=2$), the path-length difference from adjacent grooves equals two wavelengths. A three wavelength difference defines the third-order beam, and so on.

Optical spectrum analyzers utilize multiple-order beams to cover their full wavelength range with narrow resolution.

Figure 7 shows the operation of a diffraction-grating-based optical spectrum analyzer. As with the prism-based analyzer, the diffracted light passes through an aperture to the photodetector. As the diffraction grating rotates, the instrument sweeps a range of wavelengths, allowing the diffracted light — the particular wavelength depends on the position of the diffraction grating — to pass through to the aperture. This technique allows the coverage of a wide wavelength range.

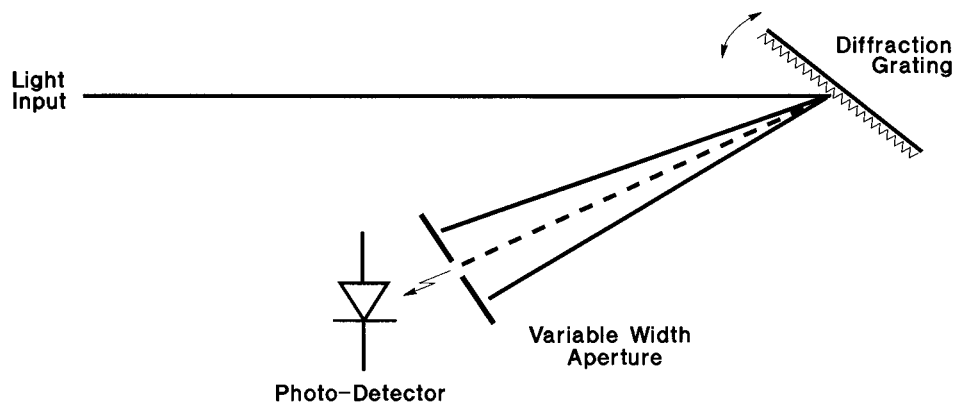

Figure 7.
Diffraction-grating-based
optical spectrum analyzer.

Single Monochromator

Diffraction-grating-based optical spectrum analyzers contain either a single monochromator, a double monochromator, or a double-pass monochromator. Figure 8 shows a single monochromator-based instrument. In these instruments, a diffraction grating is used to separate the different wavelengths of light. The second concave mirror focuses the desired wavelength of light at the aperture. The aperture width is variable and is used to determine the wavelength resolution of the instrument.

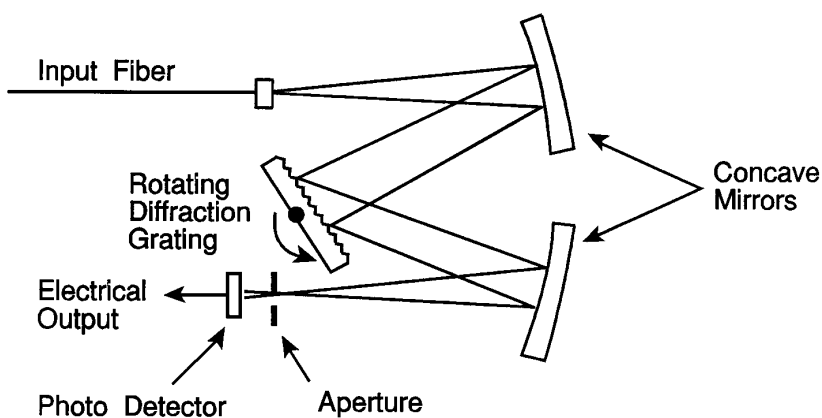

Figure 8.
Single-monochromator-based
optical spectrum analyzer.

Double Monochromator

Double monochromators, such as shown in figure 9, are sometimes used to improve on the dynamic range of single monochromator systems. Double monochromators are equivalent to a pair of sweeping filters. While this technique improves dynamic range, double monochromators typically have reduced span widths due to the limitations of monochromator-to-monochromator tuning match; double monochromators also have degraded sensitivity due to losses in the monochromators.

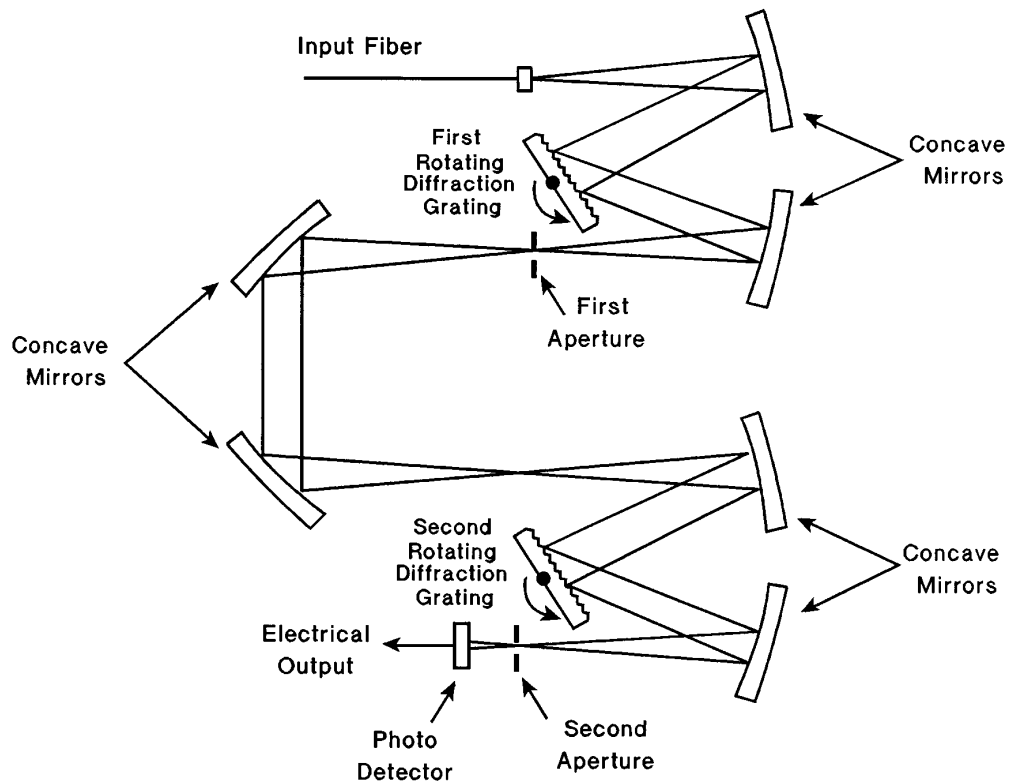

Figure 9.
Double-monochromator-based
optical spectrum analyzer.

Double-Pass Monochromator

Agilent 71450B/1B/2B optical spectrum analyzers use a unique wavelength-selection scheme – the double-pass monochromator. The double-pass monochromator provides the dynamic-range advantage of the double monochromator and the sensitivity and size advantages of the single monochromator. Figure 10 shows the double-pass monochromator.

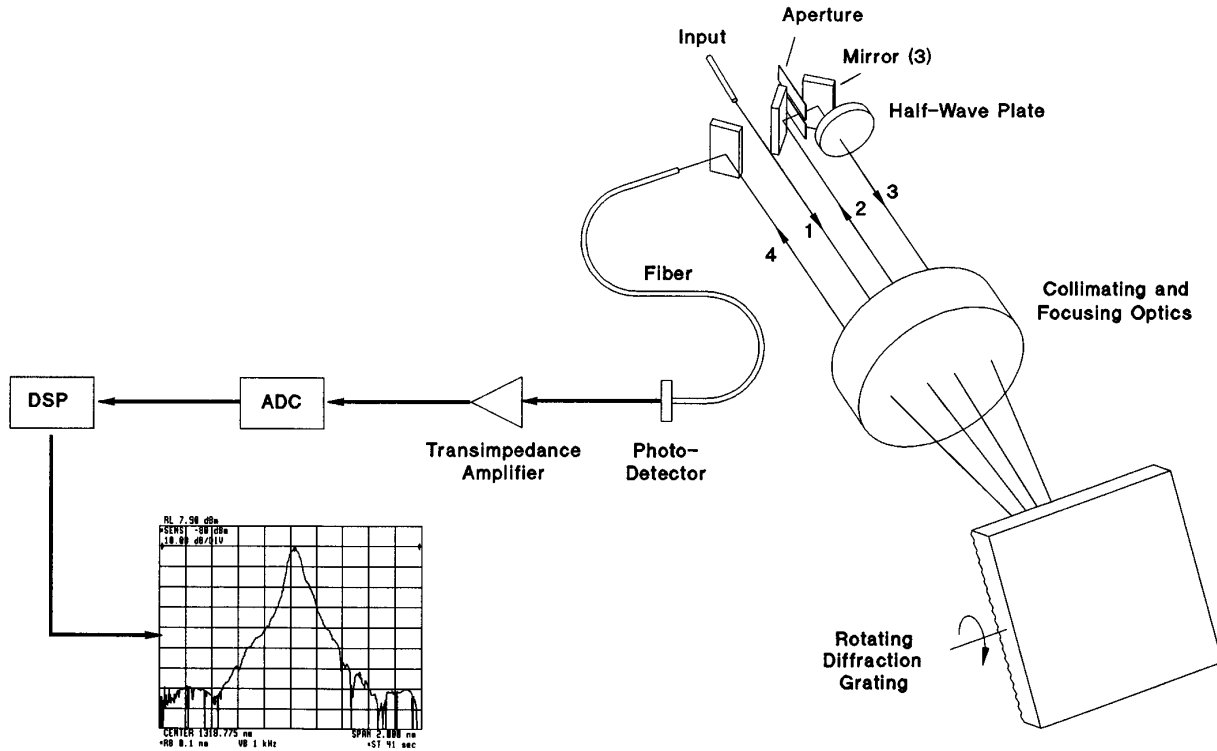

Figure 10.
Block diagram of double-pass-monochromator optical spectrum analyzer.

Wavelength Selective Filtering

The first pass through the double-pass monochromator is similar to conventional single monochromator systems. In figure 10, the input beam (1) is collimated by the optical element and dispersed by the diffraction grating. This results in a spatial distribution of the light, based on wavelength. The diffraction grating is positioned such that the desired wavelength (2) passes through the aperture. The width of the aperture determines the bandwidth of wavelengths allowed to pass to the detector. Various apertures are available to provide resolution bandwidths of 0.08 nm and 0.1 nm to 10 nm in a 1, 2, 5 sequence. In a single-monochromator instrument, a large photodetector behind the aperture would detect the filtered signal.

The Second Pass

This system shown in figure 10 is unique in that the filtered light (3) is sent through the collimating element and diffraction grating for a second time. During this second pass through the monochromator, the dispersion process is reversed. This creates an exact replica of the input signal, filtered by the aperture. The small resultant image (4) allows the light to be focused onto a fiber which carries the signal to the detector. This fiber acts as a second aperture in the system. The implementation of this second pass results in the high sensitivity of a single monochromator, the high dynamic range of a double monochromator, as well as polarization insensitivity (due to the half-wave plate). This process is discussed more completely in Chapter 2.

Chapter 2

Diffraction-Grating-Based Optical Spectrum Analyzers

Operation and Key Specifications

Wavelength Tuning and Repeatability

Tuning

The wavelength tuning of the optical spectrum analyzer is controlled by the rotation of the diffraction grating. Each angle of the diffraction grating causes a corresponding wavelength of light to be focused directly at the center of the aperture. In order to sweep across a given span of wavelengths, the diffraction grating is rotated, with the initial and final wavelengths of the sweep determined by the initial and final angles. To provide accurate tuning, the diffraction-grating angle must be precisely controlled and very repeatable over time.

Tuning Techniques

Conventional optical spectrum analyzers use gear reduction systems to obtain the required angular resolution of the diffraction grating.

To overcome problems associated with gear driven systems, Agilent Technologies optical spectrum analyzers have a direct-drive motor system which provides very good wavelength accuracy (1 nm), wavelength reproducibility and repeatability (0.005 nm), and fast tuning speed.

Wavelength Repeatability vs. Wavelength Reproducibility

Wavelength reproducibility, as defined for most optical spectrum analyzers, specifies wavelength tuning drift in a one-minute period. This is specified with the optical spectrum analyzer in a continuous sweep mode and with no changes made to the tuning.

In addition to wavelength reproducibility, Agilent specifies an additional parameter: wavelength repeatability. Wavelength repeatability is the accuracy to which the optical spectrum analyzer can be returned to a given wavelength after a change in tuning.

Wavelength Resolution Bandwidth

Full Width at Half Maximum

The ability of an optical spectrum analyzer to display two signals closely spaced in wavelength as two distinct responses is determined by the wavelength resolution. Wavelength resolution is, in turn, determined by the bandwidth of the optical filter, whose key components are the monochromator aperture, photodetector fiber, input image size, and quality of the optical components. The wavelength

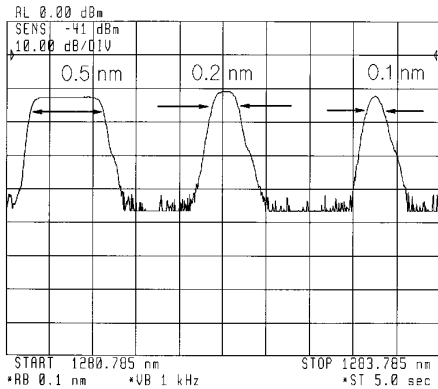

Figure 11.
Three Fabry-Perot laser
spectral components,
each measured with a
different resolution
bandwidth.

resolution is specified as the filter bandwidth at half-power level, referred to as full width at half maximum. This is a good indication of the optical spectrum analyzer's ability to resolve equal amplitude signals. The Agilent 71450B/1B/2B optical spectrum analyzers have selectable filters of 0.08 nm and 0.1 nm to 10 nm in a 1, 2, 5 sequence, which make it possible to select sufficient resolution for most measurements.

Figure 11 shows three spectral components of a Fabry-Perot laser measured with three different resolution bandwidths. In each case, the actual spectral width is much less than the resolution bandwidth. As a result, each response shows the filter shape of the optical spectrum analyzer's resolution-bandwidth filter. The main component of the filter is the aperture. The physical width of the light beam at the aperture is a function of the input image size. If the physical width of the light beam at the aperture is narrow compared to the aperture itself, the response will have a flat top, as shown in figure 11 for the 0.5 nm resolution bandwidth. This occurs as the narrow light beam is swept across the aperture. The narrower resolution-bandwidth filters result in a rounded response because the image size at the aperture is similar in size to the aperture. Each response onscreen is the convolution of the aperture with the optical image.

Dynamic Range

Based on Filter Shape Factor

For many measurements, the various spectral components to be measured are not equal amplitude. One such example is the measurement of side-mode suppression of a distributed feedback (DFB) laser, as shown in figure 12. For this measurement, the width of the filter is not the only concern. Filter shape (specified in terms of dynamic range) is also important. The advantage of double monochromators over single monochromators is that double monochromator filter skirts are much steeper, and they allow greater dynamic range for the measurement of a small spectral component located very close to a large spectral component. The double-pass monochromator has the same dynamic-range advantages as the double monochromator.

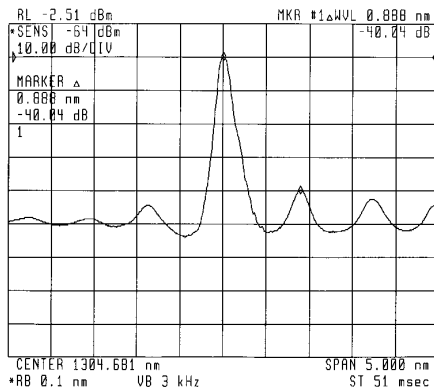

Figure 12.
DFB Laser side mode
suppression measurement.

Dynamic range is commonly specified at 0.5 nm and 1.0 nm offsets from the main response. Specifying dynamic range at these offsets is driven by the mode spacings of typical DFB lasers. A -60 dB dynamic-range specification at 1.0 nm and greater indicates that the optical spectrum analyzer's response to a purely monochromatic signal will be -60 dB or less at offsets of 1.0 nm and greater. In addition to the filter shape factor, this specification is also an indication of the stray light level and the level of spurious responses within the analyzer.

Typical dynamic range limits of single, double, and double-pass monochromators are shown in figure 13. These limits are superimposed over a display of a measurement of a spectrally pure laser, made with the double-pass monochromator. Because of their greater dynamic range, double and double-pass monochromators can be used to measure much greater side-mode suppression ratios than can single monochromators.

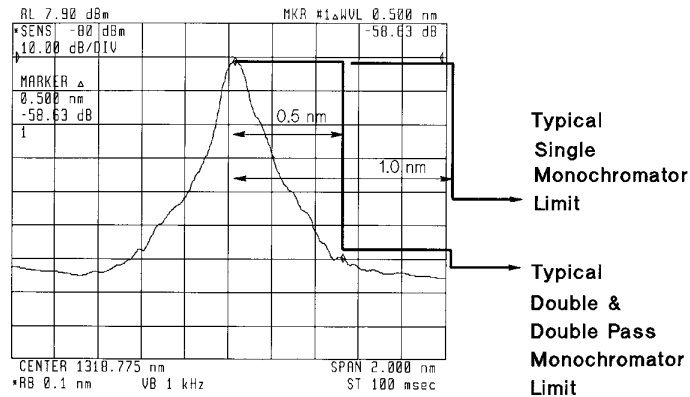

Figure 13.
Typical dynamic range limits
for single, double, and
double-pass monochromators.

Sensitivity

Directly Settable by User

Sensitivity is defined as the minimum detectable signal or, more specifically, 6 times the rms noise level of the instrument. Sensitivity is not specified as the average noise level, as it is for RF and microwave spectrum analyzers, because the average noise level of optical spectrum analyzers is 0 watts (or minus infinity dBm). (For more information on the differences between electrical and optical spectrum analyzers, see the appendix). Figure 14 shows the display of a signal that has an amplitude equal to the sensitivity setting of the optical spectrum analyzer.

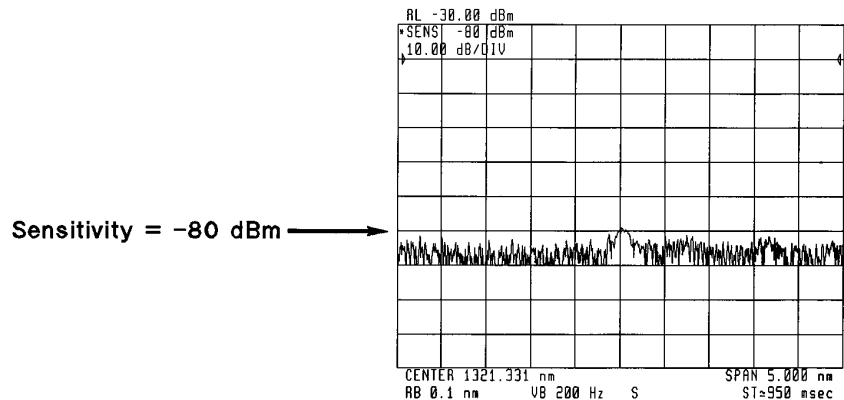

Figure 14. Display of signal with amplitude
equal to sensitivity level.

Single monochromators typically have sensitivity about 10 to 15 dB better than that of double monochromators due to the additional loss of the second diffraction grating in double monochromators. The double-pass monochromator has the same high sensitivity of single monochromators even though the light strikes the diffraction grating twice. The high sensitivity is made possible by the half-wave plate and the use of a smaller photodetector that has a lower noise equivalent power (NEP). The sensitivity improvement from the half-wave plate is discussed in the section, "Polarization Insensitivity," later in this chapter.

Sensitivity can be set directly on Agilent optical spectrum analyzers, which then automatically adjust to optimize the sweep time, while maintaining the desired sensitivity. Sensitivity is coupled directly to video bandwidth, as shown in figure 15. As the sensitivity level is lowered, the video bandwidth is decreased (or the transimpedance amplifier gain is increased), which results in a longer sweep time, since the sweep time is inversely proportional to the video bandwidth. The sweep time can be optimized because the video bandwidth is continuously variable and just enough video filtering can be performed. This avoids the problem of small increases in sensitivity causing large increases in sweep time, which can occur when only a few video bandwidths are available in fairly large steps.

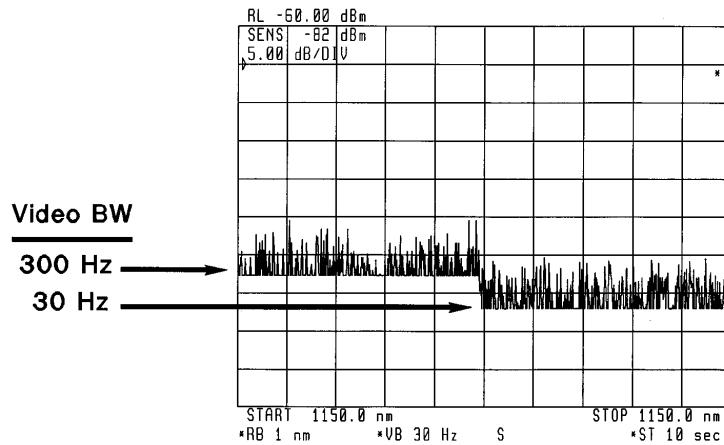

Figure 15. Video bandwidth directly affects sensitivity.

Tuning Speed

Sweep-Time Limits

For fast sweeps, sweep time is limited by the maximum tuning rate of the monochromator. The direct-drive-motor system allows for faster sweep rates when compared with optical spectrum analyzers that use gear-reduction systems to rotate the diffraction grating.

For high-sensitivity sweeps that tend to be slower, the small photodetector and continuously variable digital video bandwidths allow for faster sweep times. The small photodetector reduces the sweep time because it has a lower NEP than the large photodetectors used

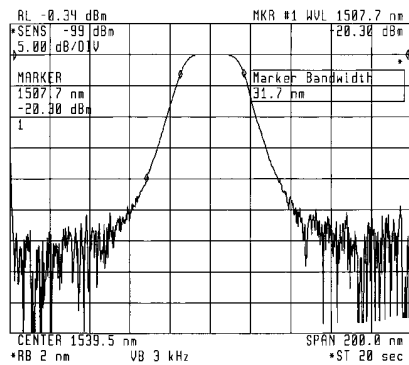

Figure 16.
Improved sweep times, even for high sensitivity measurements that traditionally result in slow sweeps. This plot shows the normalized output of an Erbium amplifier filter that was stimulated by a white-light source.

in other optical spectrum analyzers. Lower NEP means that for a given sensitivity level, a wider video bandwidth can be used, which results in a faster sweep. (Sweep time is inversely proportional to the video bandwidth for a given span and resolution bandwidth.)

The continuously variable digital video bandwidths improve the sweep time for high-sensitivity sweeps in two ways. First, the implementation of digital video filtering is faster than the response time required by narrow analog filters during autoranging. Second, since the video bandwidth can be selected with great resolution, just enough video filtering can be employed, resulting in no unnecessary sweep-time penalty due to using a narrower video bandwidth than is required. Figure 16 shows a 20 second filter-response measurement. This filter, for an Erbium amplifier, was stimulated by a white-light source, and figure 16 shows the normalized response. The purpose of this filter is to attenuate light at the pump wavelength, while passing the amplified laser output of 1550 nm. Due to the low power level of white-light sources, this measurement requires great sensitivity, which traditionally has resulted in long sweep times.

Autoranging Mode

Autoranging mode is activated automatically for sweeps with amplitude ranges greater than about 50 dB. The amplitude range is determined by the top of the screen and the sensitivity level set by the user. With the autoranging mode activated, when the signal amplitude crosses a threshold level, the sweep pauses, the transimpedance amplifier's gain is changed to reposition the signal in the measurement range of the analyzer's internal circuitry, and the sweep continues. This repositioning explains the pause that can occasionally be seen in a sweep with a wide measurement range.

Chopper Mode

The main purpose of the chopper mode is to provide stable sensitivity levels for long sweep times, which could otherwise be affected by drift of the electronic circuitry. The desired stability is achieved by automatically chopping the light to stabilize electronic drift in sweeps of 40 seconds or greater. The effect is to sample the noise and stray light before each trace point and subtract them from the trace point reading. In all modes of operation, Agilent optical spectrum analyzers zero the detector circuitry before each sweep.

Improved dynamic range is another benefit of sampling the stray light before each trace point. For measurements requiring the greatest dynamic range possible, some improvement can be obtained with the use of the chopper mode. While this mode does improve dynamic range, it is not required for the analyzers to meet their dynamic range specifications.

Figure 17 shows the improved dynamic range obtained by activating the chopper mode.

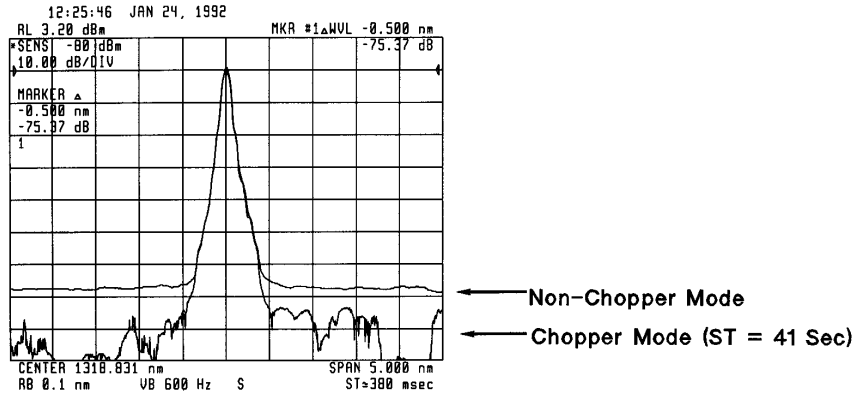

Figure 17.
Dynamic range improvement
from chopper mode.

Polarization Insensitivity

Polarization

According to electromagnetic theory, electric- and magnetic-field vectors must be in the plane perpendicular to the direction of wave propagation in free space. Within this plane, the field vectors can be evenly distributed in all directions and produce unpolarized light. A surface emitting LED provides a good illustration of the phenomena. The electric field, however, can be oriented in only one direction, as with a laser. This is called linear polarization and is shown in figure 18. Alternatively, the electric field can rotate by 360 degrees within one wavelength, such as with the vector sum of two orthogonal linearly polarized waves. Circular polarization is the term that describes two orthogonal waves that are of equal amplitude.



Linear Polarization

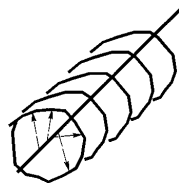

Circular Polarization

Figure 18.
Linear and circular polarization

Cause of Polarization Sensitivity

Polarization sensitivity results from the reflection loss of the diffraction grating being a function of the polarization angle of the light that strikes it. As the polarization angle of the light varies, so does the loss in the monochromator. Polarized light can be divided into two components. The component parallel to the direction of the lines on the diffraction grating is often labeled P polarization and the component perpendicular to the direction of the lines on the diffraction grating is often labeled S polarization. The loss at the diffraction grating differs for the two different polarizations, and each loss varies with wavelength. At each wavelength, the loss of P polarized light and the loss of S polarized light represent the minimum and maximum losses possible for linearly polarized light. At some wavelengths, the loss experienced by P polarized light is greater than that of S polarized light, while at other wavelengths, the situation is reversed. This polarization sensitivity results in an amplitude uncertainty for measurements of polarized light and is specified as polarization dependence.

Solution to Polarization Sensitivity Problem

To reduce polarization sensitivity, a half-wave plate has been placed in the path of the optical signal between the first and second pass in the double-pass monochromator, as shown in figure 19. This half-wave plate rotates the components of polarization by 90 degrees. The result is that the component of polarization that received the maximum attenuation on the first pass will receive the minimum attenuation on the second pass, and vice versa.

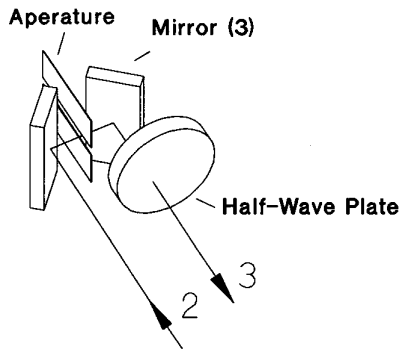

Figure 19.
Half-wave plate in the double-pass monochromator reduces polarization sensitivity and improves amplitude sensitivity.

The result is reduced polarization sensitivity, as the total loss is the product of the minimum and maximum losses, regardless of polarization. Also, because the monochromator is polarization insensitive, the monochromator output of the Agilent 71451B is also polarization insensitive. Other polarization-sensitivity-compensation techniques are currently in use, but none have a monochromator output that is polarization insensitive. This monochromator output allows the monochromator portion of the optical spectrum analyzer to be used as a preselector filter for other signal-processing applications.

Improved amplitude sensitivity over double monochromators is another benefit of the half-wave plate. This improved sensitivity is because the signal polarization can never hit the maximum loss angle twice, as can occur with a double monochromator. This benefit, along with the low NEP of the photodetector, gives Agilent optical spectrum analyzers the high sensitivity of single monochromator-based analyzers while maintaining the high dynamic range of double monochromator-based analyzers.

Input Coupling

Variety of Input Connectors Available

At the input of Agilent optical spectrum analyzers is a short, straight piece of 62.5 μm core-diameter graded-index fiber. Connection to this fiber is made using one of the interfaces listed below. The input end of this fiber is flat. The other end of this fiber, in the monochromator, is angled to help minimize reflections.

Agilent optical spectrum analyzers use user-exchangeable connector interfaces, which allow easy cleaning of the analyzer's input connector as well as the use of different connector types with the same analyzer. Available connector interfaces include FC/PC, D4, SC, Diamond HMS-10, DIN 47256, Biconic, and ST.

Appendix

Optical and Microwave Spectrum Analyzers Compared

Key Functional Blocks

The key signal processing blocks of the Agilent optical spectrum analyzers are shown in figure 20. The aperture is the primary resolution-bandwidth filter, and it determines the full-width-half-maximum bandwidth of the analyzer. Secondary filtering is performed by the coupling of the optical signal onto the fiber. This filter has a wider bandwidth than the primary filter, but it is very effective at increasing the filter shape at offsets greater than 0.3 nm from the full-width at half-maximum points on the resolution bandwidth filter. While the secondary filter has very little impact on the full-width at half-maximum bandwidth, it does provide the rejection at close offsets required to give the double-pass monochromator the high dynamic range of double monochromators.

Following the filters is the photodetector, which acts as a power detector on the light signal. The photodetector converts the optical power to an electrical current. This electrical current is converted to a voltage by the transimpedance amplifier. For the purpose of determining the internal noise level and sensitivity of the optical spectrum analyzer, the transimpedance amplifier is the main noise source. The electrical signal is digitized after the transimpedance amplifier. The video bandwidth filter, which helps to determine the sensitivity, is implemented digitally, and then the conversion to logarithmic amplitude values is performed.

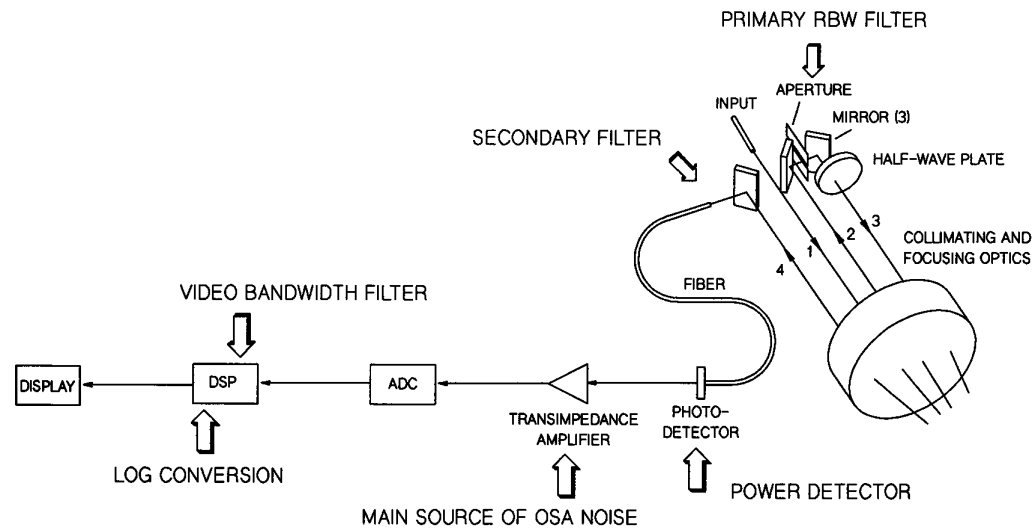

Figure 20. Key signal processing blocks of the Agilent double-pass monochromator based optical spectrum analyzers.

Block Diagram Differences

The operation of optical spectrum analyzers is very similar to microwave spectrum analyzers; however there are some differences, especially in relationship to the sensitivity of the analyzer. Figure 21 shows the key signal-processing blocks of the Agilent optical spectrum analyzers and the equivalent blocks of a typical microwave spectrum analyzer.

The order of the key signal processing elements is different, and this difference is most noticed in the sensitivity level of the analyzers. As can be seen in figure 21, the most significant source of internal noise for the microwave spectrum analyzer is at the front-end of the instrument, from the input attenuator and mixer to the EF amplifiers. The resolution bandwidth then determines the rms value of the broadband internal noise.

Reducing the resolution bandwidth reduces the instrument noise level. The signal is then converted to a logarithmic scale by the log amplifier and the envelope of that signal is detected by the detector. The noise signal seen onscreen is this envelope of the original internal noise. As a result, the resolution bandwidth, which had changed the rms value of the original noise, changes the average value of the displayed noise. The video bandwidth filter then determines the peak-to-peak width of the displayed noise, without changing the average level.

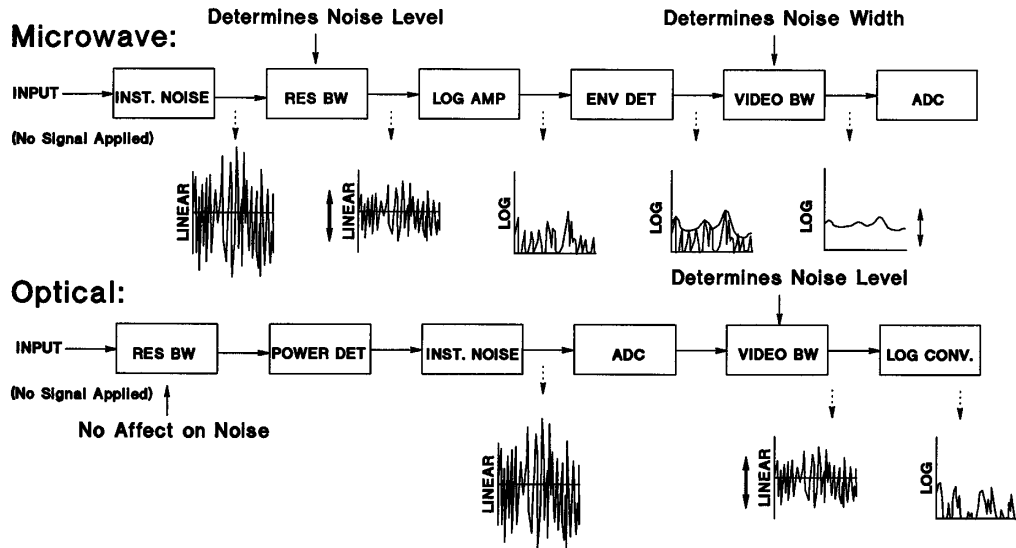

Figure 21. Key signal-processing blocks of Agilent optical spectrum analyzers and a typical microwave spectrum analyzer.

The most significant source of internal noise for the optical spectrum analyzer comes after the resolution bandwidth filters and the detector. The resolution bandwidth has no direct effect on the internal noise level. Following digitization, the video bandwidth filter is applied to the internal noise. Since this noise has not been affected by the detector, the average noise level is still 0 V. The video filter in the optical spectrum analyzer affects the rms value of the internal noise but the average remains 0 V. This is the same effect that the resolution bandwidth filter had on the internal noise at that point in the microwave spectrum analyzer. The filtered signal is then converted to a logarithmic scale for display. The average value of the displayed internal noise is 0 W (because the noise source follows the detector), which is equal to minus infinity dBm. As a result, the optical analyzer's noise floor differs because, due to the envelope detector, the microwave spectrum analyzer has a non-zero average noise level. It is the peaks of the noise floor that determine the optical spectrum analyzer's sensitivity. The sensitivity is defined as 6 times the rms noise level. In order to keep the display from being too cluttered, the internal noise is clipped 10 dB below the sensitivity point.

In summary, microwave spectrum analyzers have a non-zero average noise level that is determined by the resolution bandwidth, and the displayed width of the noise is determined by the video bandwidth. The sensitivity of the microwave spectrum analyzer is defined as the average noise level. Optical spectrum analyzers have a zero average (minus infinity dBm) noise level that is not affected by the resolution bandwidth, but the rms level of the noise is determined by the video bandwidth. The sensitivity of the optical spectrum analyzer is defined as 6 times the rms of the noise.

For convenience, operators of Agilent optical spectrum analyzers can enter the desired sensitivity, and as a result, the appropriate instrument settings, including video bandwidth and sweep time, are automatically determined and set.

For more information about Agilent Technologies test and measurement products, applications, services, and for a current sales office listing, visit our web site,

www.agilent.com/comms/lightwave

You can also contact one of the following centers and ask for a test and measurement sales representative.

United States:

Agilent Technologies
Test and Measurement Call Center
P.O. Box 4026
Englewood, CO 80155-4026
(tel) 1 800 452 4844

Canada:

Agilent Technologies Canada Inc.
5150 Spectrum Way
Mississauga, Ontario
L4W 5G1
(tel) 1 877 894 4414

Europe:

Agilent Technologies
Test & Measurement
European Marketing Organization
P.O. Box 999
1180 AZ Amstelveen
The Netherlands
(tel) (31 20) 547 2000

Japan:

Agilent Technologies Japan Ltd.
Call Center
9-1, Takakura-Cho, Hachioji-Shi,
Tokyo 192-8510, Japan
(tel) (81) 426 56 7832
(fax) (81) 426 56 7840

Latin America:

Agilent Technologies
Latin American Region Headquarters
5200 Blue Lagoon Drive, Suite #950
Miami, Florida 33126, U.S.A.
(tel) (305) 267 4245
(fax) (305) 267 4286

Australia/New Zealand:

Agilent Technologies Australia Pty Ltd
347 Burwood Highway
Forest Hill, Victoria 3131, Australia
(tel) 1-800 629 485 (Australia)
(fax) (61 3) 9272 0749
(tel) 0 800 738 378 (New Zealand)
(fax) (64 4) 802 6881

Asia Pacific:

Agilent Technologies
24/F, Cityplaza One, 1111 King's Road,
Taikoo Shing, Hong Kong
(tel) (852) 3197 7777
(fax) (852) 2506 9284

Technical data subject to change
Copyright © 1996, 2000
Agilent Technologies
Printed in U.S.A. 9/00
5963-7145E



Agilent Technologies

Innovating the HP Way