

Agilent PNA Microwave Network Analyzers

Application Note 1408-9

Amplifier and CW Swept Intermodulation-Distortion Measurements

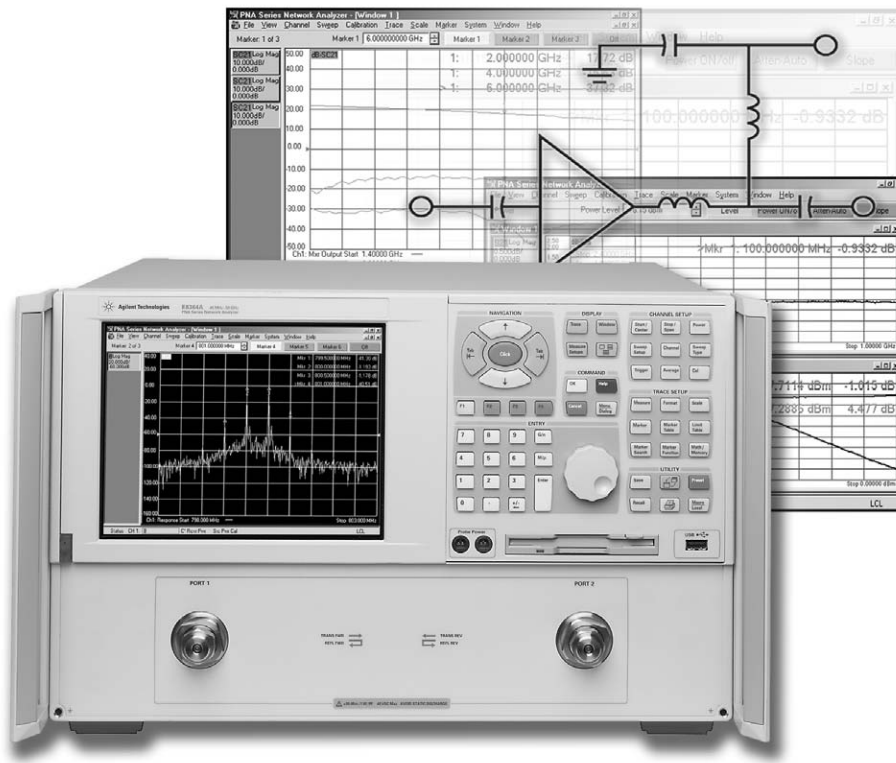
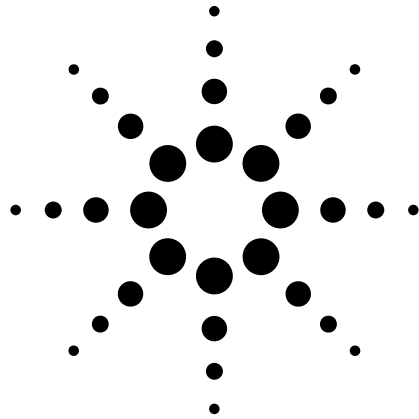

Table of Contents

Introduction	2
Intermodulation-Distortion Measurements	3
Hardware Alternatives	4
Terminology	5
Test Methodology Alternatives	6
Technique A. Four Channels, Basic Calibration, CW IMD	7
Technique A. Four Channels, Basic Calibration, Swept IMD	14
Technique B. One Channel, Basic Calibration, CW IMD	28
Technique B1. One Channel, Segmented Sweep, Basic Calibration, CW IMD	29
Technique B2. One Channel, Linear Sweep, Basic Calibration, CW IMD	33
Technique C. Four Channels Scalar-Mixer Calibration, CW IMD	37
Appendix A	38
References	40

Note: The step-by-step procedures in this application note were written for PNA (836xA/B) and PNA-L (N5230A) network analyzers with firmware revision A.04.06. If you have a PNA or PNA-L with a different firmware revision, the step-by-step procedures or screenshots may vary. The concepts and general guidelines still apply.

Introduction

This application note covers testing of an amplifier’s intermodulation distortion products using Agilent’s microwave (MW) PNA Series of vector network analyzers. The MW PNA Series can also be used for testing amplifier linear parameters, gain compression, and harmonics. Agilent Application Notes 1408-7 and 1408-8 cover the topics of linear testing, gain compression, and harmonics respectively.

Amplifiers are a fundamental building block of microwave systems, and characterizing the performance of amplifiers is a critical factor in the design process. Network analyzers are traditionally used for linear amplifier measurements, while spectrum analyzers are used for nonlinear measurements such as harmonics and intermodulation distortion. However, many of the modern network analyzers, including the Agilent MW PNA Series, can be used for nonlinear measurements as well, by enabling the frequency-offset functionality.

Most amplifier test systems include a network analyzer for reflection measurements. If the network analyzer can also be used for nonlinear measurements, then capital equipment costs are reduced.

Intermodulation-Distortion Measurements

Intermodulation distortion (IMD) is a measure of the nonlinearity of an amplifier. When two or more sinusoidal frequencies are applied to an amplifier, the output contains additional frequency components called intermodulation products. For an amplifier with input signals at f_1 and f_2 , the output will contain signals at the following frequencies: $nf_1 + mf_2$, where $n, m = 0, \pm 1, \pm 2$, etc. The third order products, $2f_2 - f_1$ and $2f_1 - f_2$, are a major concern because of their proximity to the fundamental frequencies; and the fact that their power levels increases by a factor of three, relative to an increase in the power level of the fundamental tones. Additionally, their proximity to the fundamental frequencies precludes their removal by filtering. The third order intercept point (IP3) or the third order intercept (TOI), often used interchangeably, are figures of merit for intermodulation distortion.

A power combiner should be used for two-tone IMD measurements to sufficiently isolate the sources. In some situations, it may be necessary to further isolate the sources with amplifiers. Attenuators can be used to reduce mismatch errors. In cases where source harmonics affect the intermodulation response, low pass filtering can be inserted between the amplifier and the combiner, or between the combiner and the receiver, to reduce harmonics. This measurement must be performed in the linear operating region of the amplifier to ensure a correct intercept point calculation.

The MW PNA can be used for two-tone distortion measurements. The third order products can be measured using the frequency-offset mode Option 080. A source-power cal and receiver cal provide accurate data. Alternatively, you can use the scalar-mixer cal offered with the Frequency Converter Application, Option 083. Due to the shape of the MW PNA's digital signal processing filters, we recommend using tone-spacings wider than 100 kHz.

Hardware Alternatives

There are three methods of making intermodulation distortion measurements using the MW PNA.

Method 1

Use the MW PNA as both a source and a receiver. One tone is generated by the network analyzer and a second tone is generated by an external source. The MW PNA is used to measure all tones. In this case, the user is taking advantage of the network analyzer's capability of both being a source and a receiver.

Method 2

Use two external sources for the two tones, and the MW PNA as the receiver.

Method 3

Use one external source only, but use one that can produce two tones. Agilent ESG and PSG signal generators with the Optional "Internal dual arbitrary waveform generator" can produce a two-tone signal. The MW PNA is simply used as a receiver. If you are using method C with an ESG, Agilent offers a free software application that can help you with the measurement. Ask your local Agilent sales engineer for the third-order intermodulation distortion (TOI) application. The limiting factor may be the spectral purity of the signal generator.

In this application note, we use method 1, using the MW PNA as both a source and receiver. The MW PNA's source is used as the source for the f_1 fundamental tone, while a PSG signal generator is used as the source for the f_2 tone. The MW PNA's receiver is setup to measure the four tones: two fundamental, and two third order products. The hardware setup shown in Figure 1 is used for CW intermodulation distortion measurements.

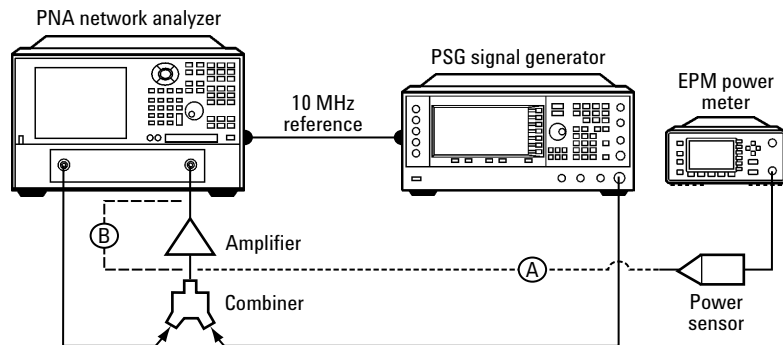

Figure 1. Two-tone intermodulation distortion setup. Path A is the necessary connection for source power calibration. Path B, a through connection that includes the combiner, is the necessary connection for receiver calibration.

1. Recommended tone spacing > 100 kHz

Terminology

Note

MW PNA [front-panel keys] are shown in brackets, while the **softkeys** are displayed in bold; "menu item" refers to the Windows® drop down menus.

f_1 = Fundamental low-side tone
 f_2 = Fundamental high-side tone
 Δf = $f_2 - f_1$ = Tone spacing¹:
 $2f_1 - f_2$ = low-side mixing product,
 a third-order product
 $2f_2 - f_1$ = high-side mixing product,
 a third-order product

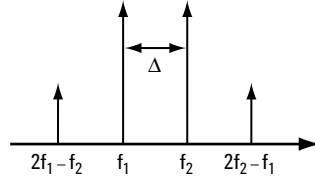

Figure 2. Fundamental tones and third-order mixing products.

$P(f_1)$ = Output power of the fundamental tone

$P(2f_2 - f_1)$, $P(2f_1 - f_2)$ = Output power at mixing product tones

Assuming the two input signals are of equal magnitude, the third order intercept point, IP3, is then calculated from:

$$\text{TOI or IP3 (dBm)} = \text{Output power of a fundamental tone } (f_1 \text{ or } f_2) \text{ (dBm)} + 1/2 * \{ \text{Output power of a fundamental tone } (f_1 \text{ or } f_2) - \text{maximum } (2f_2 - f_1, 2f_1 - f_2) \} \text{ (dB)}$$

In this application note, the device under test (DUT) is an amplifier with the following specifications.

Frequency range	0.10 to 1000 MHz
Minimum small signal gain	20 dB
Input SWR	1.5:1
Output SWR	2.0:1
Output 1 dB compression	+3 dBm
Third order intercept	+14 dBm

Test Methodology Alternatives

Intermodulation distortion products can be measured using four different techniques, described in the table below.

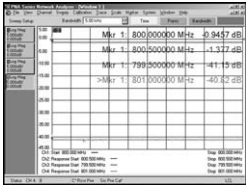
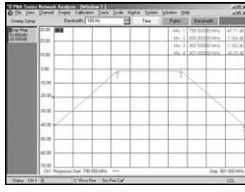
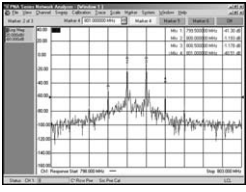
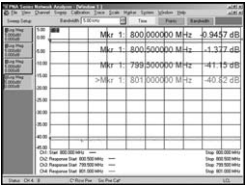
	Technique A Four channels, basic calibration	Technique B1 One channel, segmented sweep, basic calibration	Technique B2 One channel, linear sweep, basic calibration	Technique C Four channel, scalar-mixer calibration
Screen image				
Network analyzer options	Frequency-offset mode (Option 080)	Frequency-offset mode (Option 080)	Frequency-offset mode (Option 080)	Frequency-offset mode (Option 080) and frequency converter application (Option 083)
Description	Multiple channels are used to measure the input signals and intermodulation products. Channel 1 is configured to measure the fundamental f_1 , channel 2 to measure f_2 , channel 3 to measure $2f_1 - f_2$, and channel 4 to measure $2f_2 - f_1$.	Uses the "CW override" feature of frequency-offset mode. Involves using one channel, with the source at one of the fundamental CW frequencies, and the receiver sweeping across the four tones. A segmented sweep is used to measure four tones.	Uses the "CW override" feature of frequency-offset mode. Involves using one channel, with the source at one of the fundamental CW frequencies, and the receiver sweeping across the four tones. A linear sweep is used to measure at least from $2f_2 - f_1$ to $2f_1 - f_2$, covering the range of the four tones.	Multiple channels are used to measure the input signals and intermodulation products. Channel 1 is configured to measure the fundamental f_1 , channel 2 to measure f_2 , channel 3 to measure $2f_1 - f_2$, and channel 4 to measure $2f_2 - f_1$.
IMD type	CW and swept	CW only	CW only	CW and swept
Calibration	Source-power and receiver calibration	Source-power and receiver calibration	Source-power and receiver calibration	Scalar-mixer calibration (SMC) provides match-corrected power measurements.
Advantages of each technique	If receiver frequency has to be offset due to tone spacing close to 8.333 MHz, technique A is the only accurate technique, since two of the tones require an offset. See Appendix A.	<ul style="list-style-type: none"> • One channel, one sweep, therefore faster than techniques A and C, which require four channels and multiple sweeps. • Faster calibration and measurement time than technique B2, since only four points are measured, versus 201+. • Easy calculation of IMD product, using delta marker functions. 	<ul style="list-style-type: none"> • Intuitive display, similar to a spectrum analyzer. • One channel, one sweep, therefore faster than techniques A and C, which require four channels and therefore four sweeps. • Easy calculation of IMD product, using delta marker functions. 	<ul style="list-style-type: none"> • Has a simple guided calibration that corrects for mismatch. • If the device under test has perfect match, there is no difference between the accuracy of technique A, B, and C. The worse the match or the device, the more advantage there is to using technique C versus A and B.

Technique A. Four Channels, Basic Calibration

Multiple channels are used to measure the multiple frequencies. Channel 1 is configured to measure the fundamental f_1 , or low-side tone; channel 2 to measure f_2 , or the high-side tone; channel 3 to measure $2f_1 - f_2$ or the low-side mixing product; and channel 4 to measure $2f_2 - f_1$, or the high-side mixing product.

The table below shows the stimulus and response settings we want to achieve.

Intermodulation distortion measurement steps

Step	Goal	Source frequency	FOM Offset (Multiplier x1)	Resulting receiver frequency
1	Setup measurement for source-power calibration ¹	Ch 1: $2f_1 - f_2 \rightarrow 2f_2 - f_1$	0	$2f_1 - f_2 \rightarrow 2f_2 - f_1$
2	Source-power calibration			
2	Copy channel 1 to channels 2, 3 and 4, and setup channels 2, 3, and 4 as B receiver traces.			
2	Receiver calibration			
3	Modify the input frequencies of all channels to f_1 .	Ch 1: f_1 Ch 2: f_1 Ch 3: f_1 Ch 4: f_1	0 0 0 0	Ch 1: f_1 Ch 2: f_1 Ch 3: f_1 Ch 4: f_1
3	Modify the FOM offset on all channels to tune receiver to appropriate frequency.	Ch 1: f_1 Ch 2: f_1 Ch 3: f_1 Ch 4: f_1	0 Δf $-\Delta f$ $2\Delta f$	Ch 1: f_1 Ch 2: f_2 Ch 3: $2f_1 - f_2$ Ch 4: $2f_2 - f_1$
4	Connect amplifier and complete distortion measurement.			

Note

We recommend that if the tone spacing is close to 8.333 MHz, when measuring the low-side tone or low-side mixing product, shift the receiver offset frequency by -16.667 MHz. See Appendix A for more information on this topic, along with the recommended stimulus setting for such a measurement case.

Steps to generate the above table settings:

Step 1: Setup measurement for source-power calibration

[Preset]

[Start/Center] > Start > 799.5 [M/μ] > Stop > 801 [M/μ]

[Power] > Level > -20 > [Enter]

[Sweep Setup] > Points > 401 [Enter]

Select frequency-offset mode and activate it, with a zero offset and x1 multiplier and divisor. Menu item **Channel > Frequency Offset...**

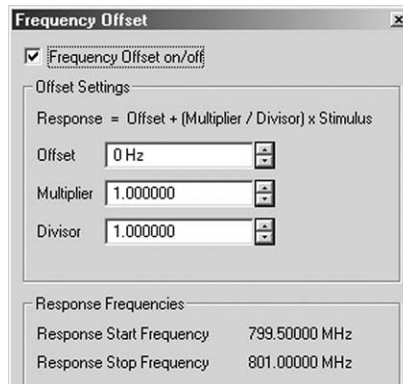

Figure 3. Configure channel 1 to cover the entire frequency range.

1. Since source-power calibration is a time consuming task, and the frequency span of interest is narrow, we perform a wideband source-power cal, and then copy the channel (along with the calibration) to other channels. Since receiver cal is not part of a channel setting, it is not copied over, and we have to perform the receiver cal on channels individually.

Step 2: Calibrate

Source-power calibration

Connect a power sensor to the output of the combiner and perform a source-power calibration. Make sure that RF power is off, on the PSG signal source which supplies the second tone. From the menu select:

Calibration > Power Calibration ... > Source Power Cal > Take Cal Sweep

You may want to choose a different test-port power level from the cal power. In this example, the combiner has approximately 4 dB of loss, therefore we set the test-port power to -20 dBm, while the cal power was set to -24 dBm.

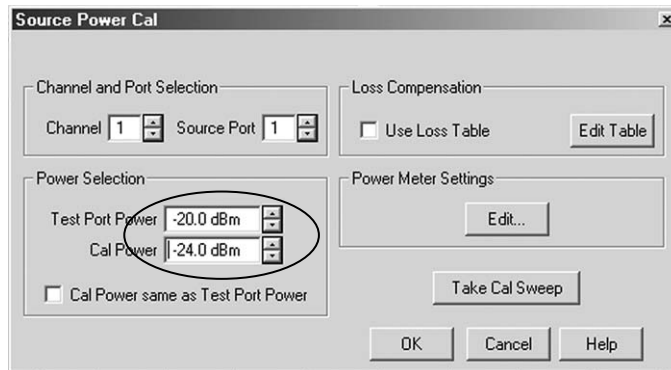

Figure 4. A source-power cal provides accurate input power to the DUT and is a basis for receiver calibration.

Once the calibration is complete, you should see the “**Src Pwr Cal**” indicator on the status bar.

Copy channels

Copy channel 1 to channels 2, 3, and 4 and configure all channels to a B measurement. The “**Src Pwr Cal**” indicator should continue to remain valid on all channels.

From the menu, select:

Channel > Copy Channel ...

Note

The copy channel features copies *channel characteristics* such as frequency range, number of points, two-port and source calibration. *Trace characteristics* such as S_{21} , B, or format are not copied. Today, receiver calibration is not a channel characteristic; it is a trace characteristic, and therefore not copied.

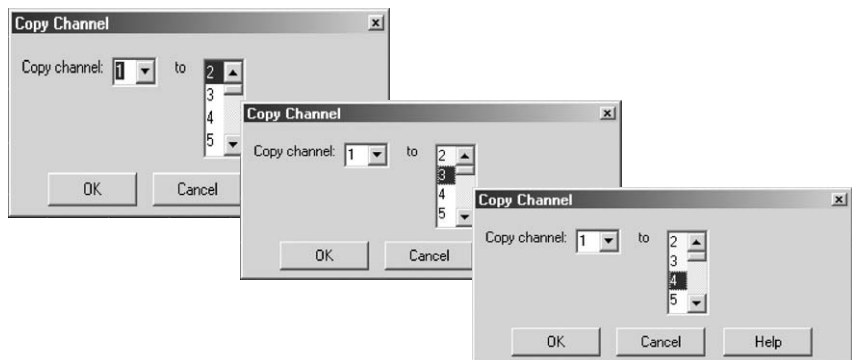

Figure 5. Copy channel 1 to channels 2, 3, and 4 to measure the second fundamental tone, low-side mixing product, and high-side mixing product.

Configure all channels to make a B measurement. Menu item **Trace > Measure > Measure > More Types ...**

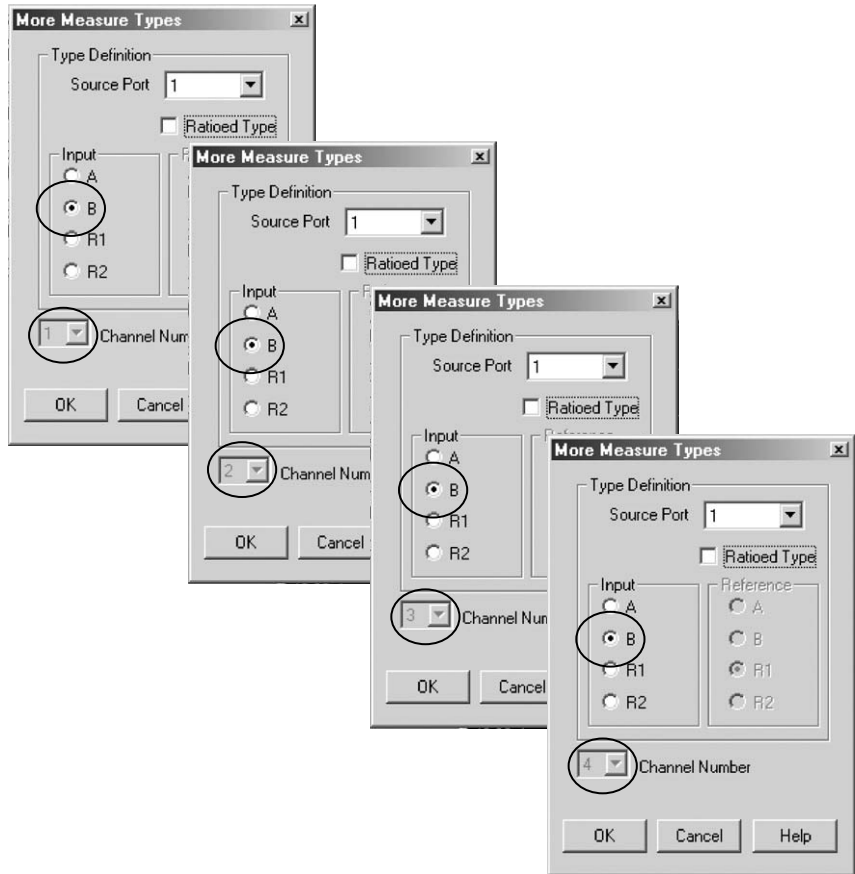

Figure 6. Configure each channel to the measure the B receiver value.

Receiver calibration

Make a through connection between MW PNA port 1 and 2 and perform a receiver calibration on all channels. For through connection, MW PNA port 1 is connected to the input of the combiner, and the output of the combiner is connected to MW PNA port 2. Again, make sure the PSG signal generator RF power is off. Repeat this procedure for all four channels.

Channel 1: **Calibration > Power Calibration ... > Receiver Power Cal > Take Cal Sweep**

Channel 2: **Calibration > Power Calibration ... > Receiver Power Cal > Take Cal Sweep**

Channel 3: **Calibration > Power Calibration ... > Receiver Power Cal > Take Cal Sweep**

Channel 4: **Calibration > Power Calibration ... > Receiver Power Cal > Take Cal Sweep**

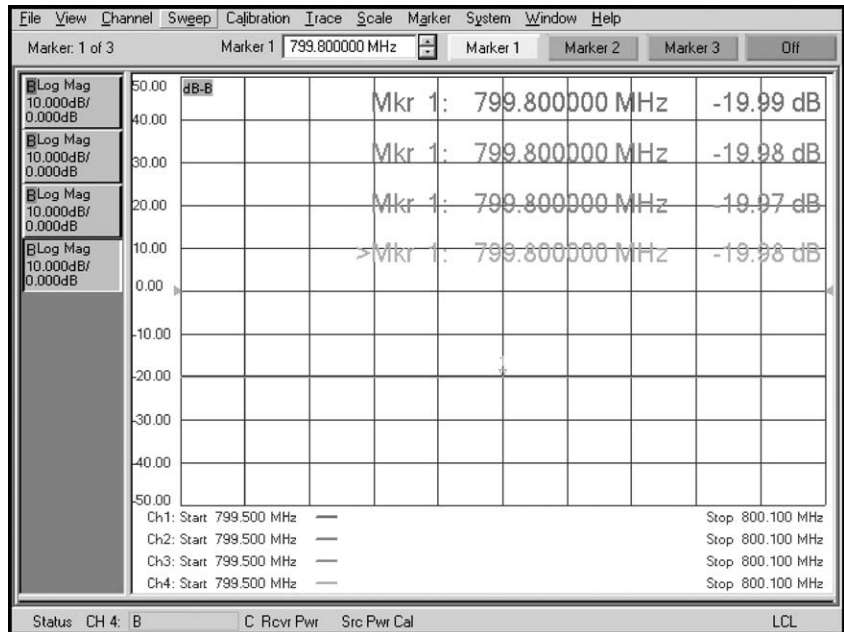

Figure 7. Verify that all channels have valid calibration.

Configure the signal source for the appropriate settings. In this case, set the PSG signal source to 800.5 MHz, with a power level of -20 dBm.

Step 3: Modify settings

Modify stimulus

Reduce the stimulus frequency range to the fundamental frequency.

[Start/Center]

Select channel 1: **Start 800 [M/μ] > Stop 800 [M/μ]**

Select channel 2: **Start 800 [M/μ] > Stop 800 [M/μ]**

Select channel 3: **Start 800 [M/μ] > Stop 800 [M/μ]**

Select channel 4: **Start 800 [M/μ] > Stop 800 [M/μ]**

Modify frequency-offset settings

Modify the frequency-offset mode settings to measure the appropriate response.

Select channel 1: Leave as is, to measure f_1 of 800 MHz.

Select channel 2: Set up to measure high-side tone at f_2 at 800.5 MHz.

Channel > Frequency Offset...

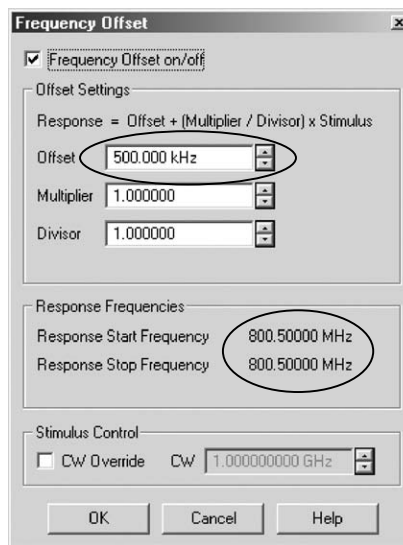

Figure 8. Set up to measure high-side tone.

Channel 3: Setup to measure low-side mixing product: $2f_1 - f_2$ at 799.5 MHz.

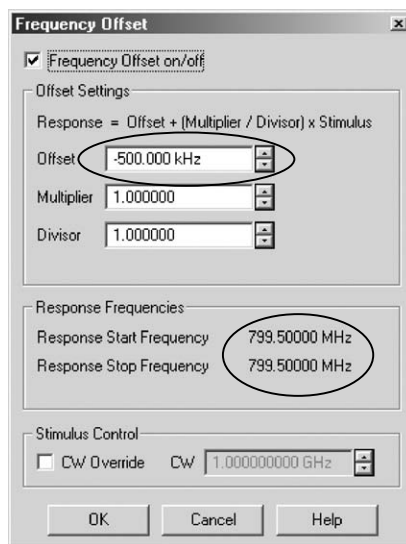

Figure 9. Set up to measure low-side mixing product.

Channel 4: Set up to measure high-side mixing product: $2f_2 - f_1$ at 801 MHz.

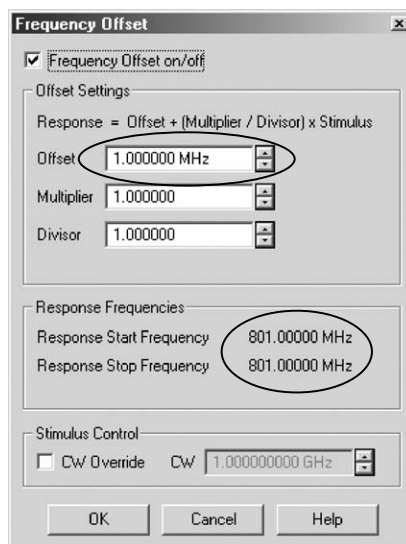

Figure 10. Set up to measure high-side mixing product.

Step 4: Measure

Connect the amplifier input to the combiner output and amplifier output to the MW PNA port 2. Channels 1 and 2 should show approximately the same power level, as one of the requirements of two-tone intermodulation testing is that the input power levels be the same. This power level should be the input power level plus the gain of the amplifier. Channels 3 and 4 should show values generally greater than 30 dB lower than channels 1 and 2, as channels 3 and 4 are displaying the level of the intermodulation distortion products.

In our example, channels 1 and 2 show approximately 0 dBm (–20 dBm input power, 20 dB amplifier gain). Channels 3 and 4 show approximately –40 dBm.

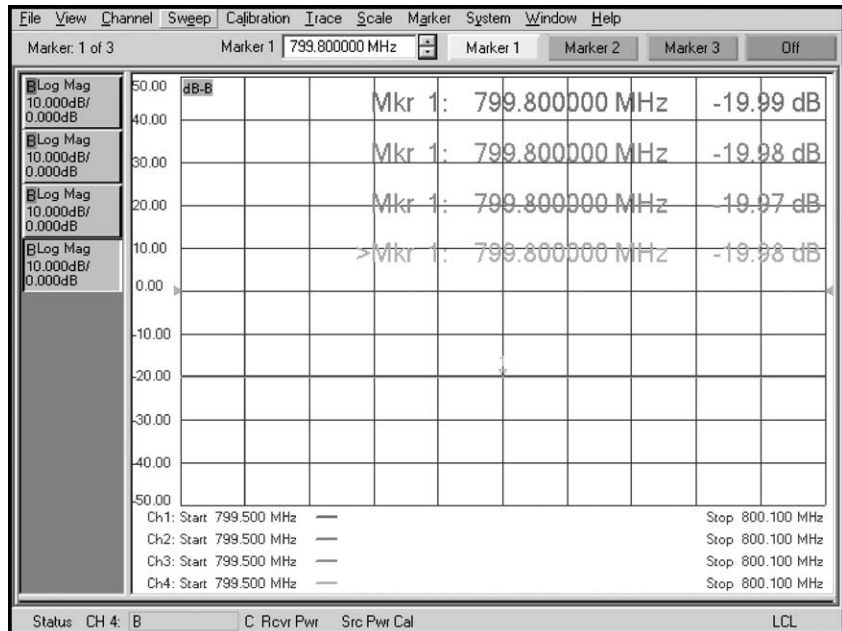

Figure 11. Measure distortion products on the MW PNA.

The equation to calculate the third order intercept is:

$$IP3 \text{ (dBm)} = P(f_1) + 1/2 [P(f_1) - \max\{P(2f_2 - f_1), P(2f_1 - f_2)\}]$$

$$P(f_1) = \text{Output power} \approx 0 \text{ dBm in this example}$$

$\max\{P(2f_2 - f_1), P(2f_1 - f_2)\}$ is the worst case reading between channels 3 and 4. Worst case is the larger value in dB. In this example, it is channel 3 for approximately –41 dBm.

$$IP3 \text{ (dBm)} = -0.9457 + 1/2 [-0.9457 - (-41.15)] = +19 \text{ dBm}$$

The IP3 of this DUT is +19 dBm at 800 MHz, with –20 dBm input power.

Technique A. Four Channels, Basic Calibration, Swept IMD

Swept Intermodulation Distortion Hardware Setup

In this application note, the MW PNA's source is used as the source for the f_1 fundamental tone, while a PSG signal generator is used as the source for the f_2 fundamental tone. The MW PNA's receiver is set up to measure the four tones: two fundamental, and two third order products. Since the MW PNA is equipped with frequency-offset mode, the network analyzer source and receiver can be set to different frequencies. The hardware setup shown in Figure 12 is used for swept intermodulation distortion measurements. Since we are measuring Swept TOI, the PNA and PSG need to be synchronized, so it is necessary to connect the trigger lines between the two instruments.

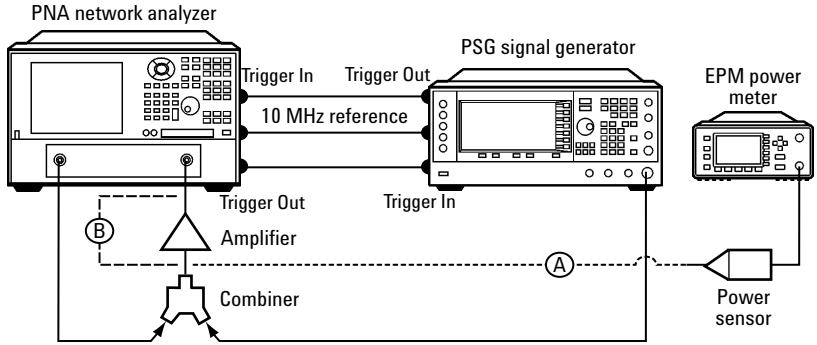

Figure 12. Two-tone swept intermodulation distortion setup. Path A is the necessary connection for source power calibration. Path B, a through connection that includes the combiner, is the necessary connection for receiver calibration.

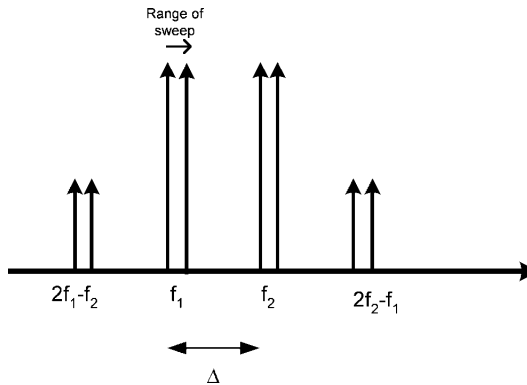

Figure 13. Fundamental tones and mixing products.

Measurement Procedure

We will configure the PNA source to sweep the fundamental tone range, while setting up the PSG signal generator to sweep the second fundamental tone range. On the receiver side, we use four PNA channels to measure the four different tones. Channel 1 is configured to measure the fundamental f_1 or low-side tones; channel 2 to measure f_2 or the high-side tones; channel 3 to measure $2f_1 - f_2$ or the low-side mixing products; and channel 4 to measure $2f_2 - f_1$ or the high-side mixing products.

The table below shows the necessary steps to make a swept IMD measurement using a PNA and PSG. The following pages explain the steps to generate these settings.

Step	Goal	Source frequency	FOM Offset (Multiplier x1)	Resulting receiver frequency
1	Setup measurement for source power calibration ¹	Ch 1: lowest to highest frequency	0	$2f_1 - f_2 \rightarrow 2f_2 - f_1$
2	Source power calibration			
2	Copy channel 1 to channels 2, 3 and 4, and setup channels 2, 3, and 4 as B traces.			
2	Receiver calibration			
3	Modify the input frequencies of all channels to the range of f_1	Ch 1: f_1 Ch 2: f_1 Ch 3: f_1 Ch 4: f_1	0 0 0 0	Ch 1: f_1 Ch 2: f_1 Ch 3: f_1 Ch 4: f_1
3	Modify the FOM setting on all channels to tune receiver to appropriate frequencies	Ch 1: f_1 Ch 2: f_1 Ch 3: f_1 Ch 4: f_1	0 Δf $-\Delta f$ $2\Delta f$	Ch 1: f_1 Ch 2: f_2 Ch 3: $2f_1 - f_2$ Ch 4: $2f_2 - f_1$
4	Set up the PNA for external triggering			
5	Configure the PSG signal source			
6	Synchronize the PNA and PSG sweeps			
7	Connect amplifier and complete distortion measurement			

1. Since source power calibration is a time consuming task, and the frequency span of interest is narrow, we perform a wideband source power cal, and then copy the channel (along with the calibration) to other channels. Since receiver cal is not part of a channel setting, it is not copied over, and we have to perform the receiver cal on channels individually.

Steps to generate the previous table settings:

Step 1: Set up measurement for source-power calibration

In this example, we test the amplifier over the frequency range of 800 to 810 MHz, with an input power level of -20 dBm. The selected tone spacing is 400 kHz.

Fundamental tone range:	800.0 - 810.0 MHz
Second fundamental tone range (400 kHz offset):	800.4 - 810.4 MHz
Low-side mixing products:	799.6 - 809.6 MHz
High-side mixing products:	800.8 - 810.8 MHz

Calibrate the source and receiver over the entire frequency range of test.

[Preset]

[Start/Center] > Start > 799.6 [M/u] > Stop > 810.8 [M/u]

[Power] > Level > -20 > [Enter]

[Sweep Setup] > Points > 101 [Enter]

[Sweep Setup] > Bandwidth > 1000 [Enter] (1 kHz IFBW)

Select frequency-offset mode and activate it with a zero offset and x1 multiplier and divisor.
Menu item **Channel > Frequency Offset...**

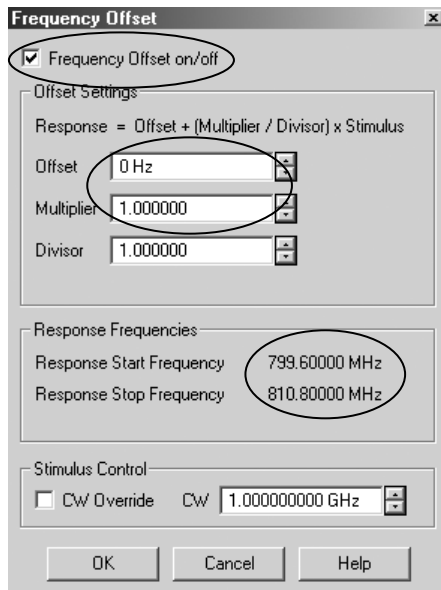

Figure 14. Configure channel 1 to cover the entire frequency range.

Step 2: Calibrate

Source power calibration

Connect a power sensor to the output of the combiner and perform a source power calibration. Make sure that RF power is off, on the PSG signal source which supplies the second tone. You may want to choose a different test port power level from the calibration power. In this example, the combiner has approximately 4 dB of loss, therefore we set the test port power to -20 dBm and enter a -4 dB power offset.

From the menu select:

Calibration > Power Calibration ... > Source Power Cal > Take Cal Sweep

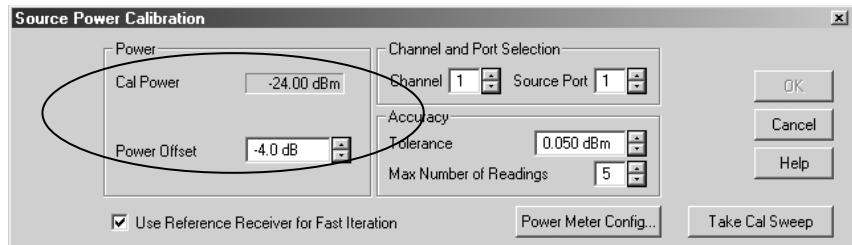

Figure 15. A source power cal provides accurate power to the DUT and is a basis for receiver calibration.

Once the calibration is complete, you should see the **Src Pwr Cal** indicator on the status bar.

Copy channels

Copy channel 1 to channels 2, 3, and 4 and configure all channels to a B measurement. The **Src Pwr Cal** indicator should continue to remain valid on all channels.

Menu item **Channel > Copy Channel ...**

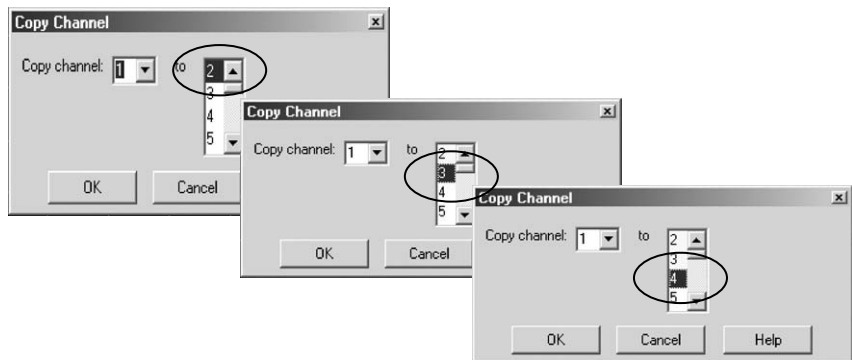

Figure 16. Copy channel 1 to channels 2, 3 and 4 to measure the second fundamental tone, low-side mixing product, and high-side mixing product.

Configure all channels to make a B measurement. Menu item **Trace > Measure > Measure > More Types ...**

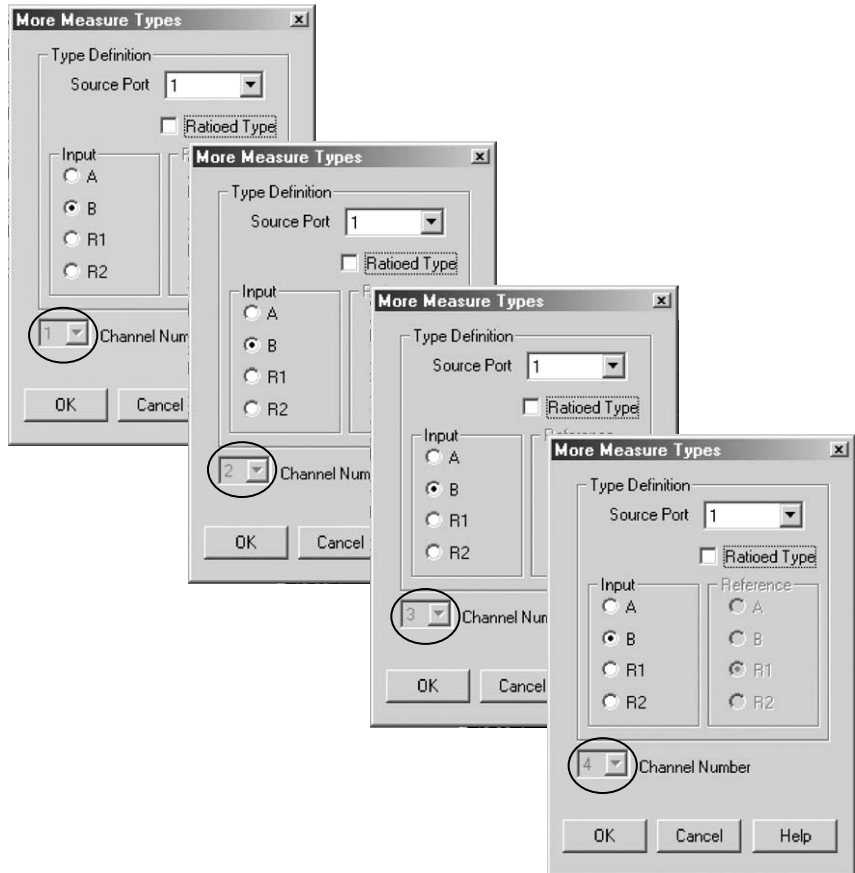

Figure 17. Configure each channel to the measure the B receiver value.

Receiver calibration

Make a through connection between port 1 and 2 and perform a receiver calibration on all channels. A through connection would include the combiner, that is, port 1 is connected to the input of the combiner, and the output of the combiner is connected to port 2. Again, make sure the PSG signal generator RF power is off. Repeat this procedure for all four channels.

Channel 1: **Calibration > Power Calibration ... > Receiver Power Cal > Take Cal Sweep**

Channel 2: **Calibration > Power Calibration ... > Receiver Power Cal > Take Cal Sweep**

Channel 3: **Calibration > Power Calibration ... > Receiver Power Cal > Take Cal Sweep**

Channel 4: **Calibration > Power Calibration ... > Receiver Power Cal > Take Cal Sweep**

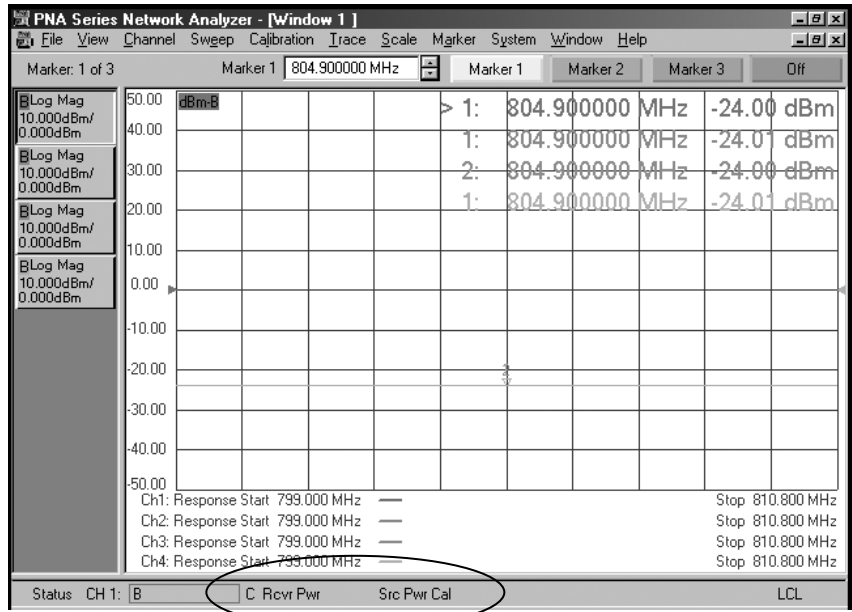

Figure 18. Verify that all channels have valid calibration.

Step 3: Modify settings

Modify stimulus

Reduce the stimulus frequency range to the fundamental frequency.

[Start/Center]

Select channel 1: **Start 800 [M/μ] > Stop 810 [M/μ]**

Select channel 2: **Start 800 [M/μ] > Stop 810 [M/μ]**

Select channel 3: **Start 800 [M/μ] > Stop 810 [M/μ]**

Select channel 4: **Start 800 [M/μ] > Stop 810 [M/μ]**

Modify frequency-offset settings

Modify the frequency-offset mode settings to measure the appropriate response.

Select channel 1: Leave as is, to measure f_1 of 800 to 810 MHz.

Select channel 2: Set up to measure high-side tones, f_2 , from 800.4 to 810.4 MHz.

Channel > Frequency Offset...

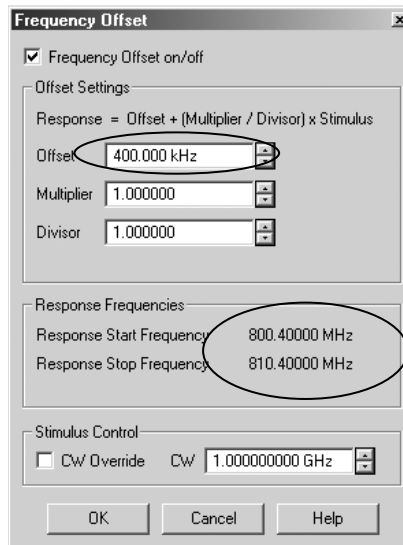

Figure 19. Set up to measure high-side tone

Channel 3: Set up to measure low-side mixing products, $2f_1 - f_2$, at 799.6 - 809.6 MHz.

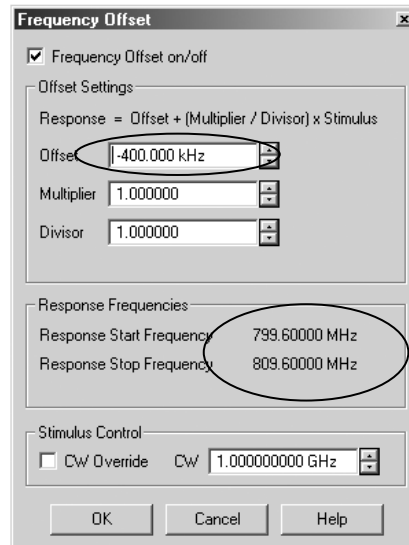

Figure 20. Set up to measure low-side mixing product.

Channel 4: Set up to measure high-side mixing products, $2f_2 - f_1$, from 800.8 - 810.8 MHz.

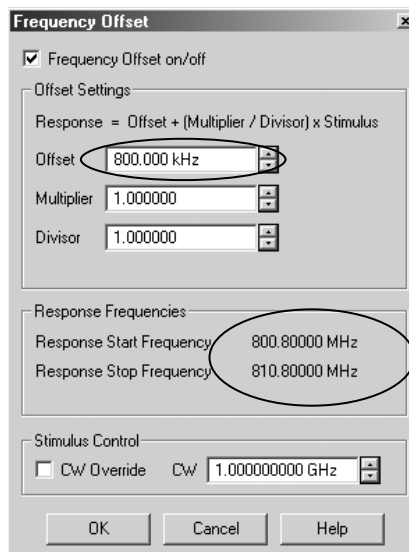

Figure 21. Set up to measure high-side mixing product.

Step 4: Set up the PNA for external triggering

The next step involves setting up the network analyzer for external triggering. In this application note, the necessary triggering steps for setting up a swept intermodulation measurement are described. For more information on the triggering capabilities of the PNA, refer to either the online help system or the Agilent white paper *“Triggering PNA Microwave Network Analyzers for Antenna Measurements”*, literature number: 5988-9518EN.

From the Sweep menu, select **Trigger > Trigger ...**

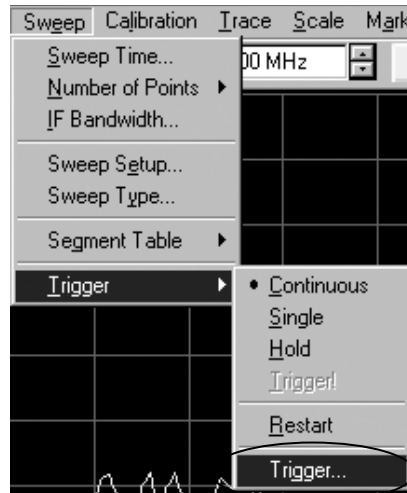

Figure 22. Select the triggering function in order to allow the PNA and PSG to communicate.

Select **External** triggering, so that the PNA can be triggered by the PSG and trigger the PSG, in return. Then select **Channel** triggering and following that, select **Point Sweep** triggering for all four channels.

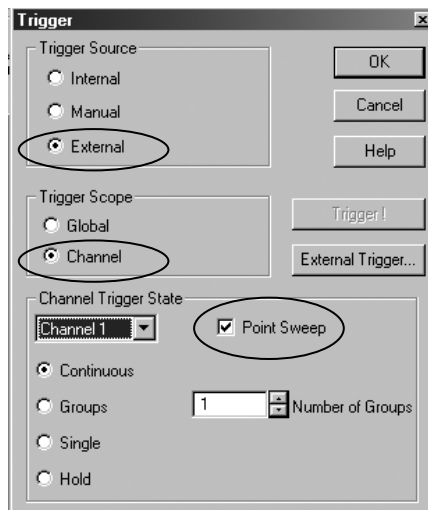

Figure 23. Select **External Triggering**, **Channel Triggering**, and **Point Sweep** mode.

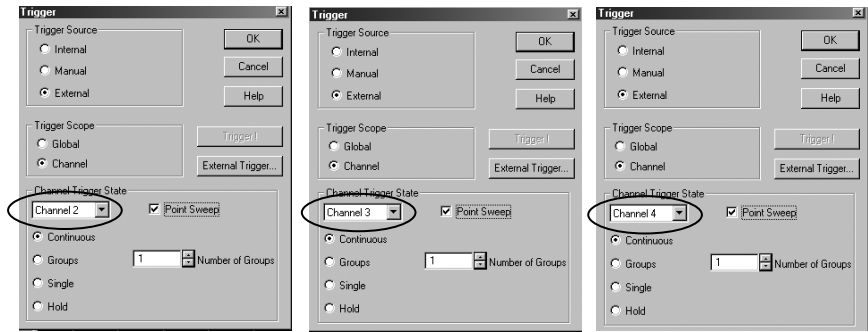

Figure 24. Make sure you select *Point Sweep* for all four channels.

Next, adjust the *External Trigger* settings to the appropriate levels. The level/edge triggering on the input and output should match the choice made on the PSG. In this example, we use negative edge triggering. You can use positive edge triggering also; just make sure the PSG is set for positive triggering as well.

From the Sweep menu, select **Trigger > Trigger ...> External Trigger ...**

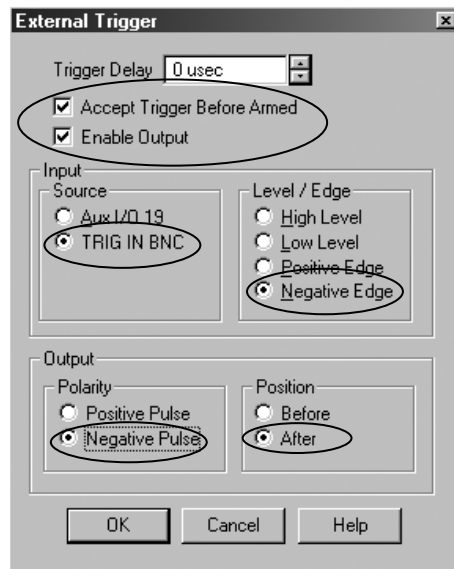

Figure 25. The level/edge triggering on the input and output should match the choice made on the PSG. In this example, we use negative edge triggering.

The next step is to configure the signal source for the appropriate settings and then synchronize the source and the network analyzer.

Step 5: Set up the PSG signal source

The signal source needs to be configured to sweep the second fundamental tone. In this example, that would be the frequency range of 800.4 to 810.4 MHz, with a power level of -20 dBm. The source used in our example is a PSG Vector Signal Generator. With the PSG, you can either use the stepped or list sweep type. We will use the stepped mode, so it is similar to the PNA.

Note

Make sure the number of points matches what you selected on the PNA. We set each channel up with 101 points on the PNA, so we need to setup the PSG for 101 points also.

PSG settings:

[Preset]

[Sweep/List]

Sweep > Freq

Sweep Type > Step

Configure Ramp/Step Sweep > Freq Start 800.4 MHz > Freq Stop 810.4 MHz

Points 101

[Amplitude] -20 dBm

[RF On]

[Mod Off]

[Sweep/List] > More (1 of 2) >

Sweep Trigger (Free Run)

Point Trigger > External

Trigger In Polarity Neg

[Return]

Trigger Out Polarity Neg

Note

The triggering polarity needs to match what you selected on the PNA. In this example, we used negative polarity on the PNA, so we need to setup the PSG for negative polarity also.

Step 6: Synchronize the PNA and PSG sweeps

Now both the PNA and PSG have the basic triggering setup. The next few keys describe the procedure needed to synchronize the two instruments' sweeps.

Set PSG **Manual Mode** to On

[Sweep/List] > More (1 of 2) > Manual Mode Off **On**

On the PNA, on all four channels, trigger from Restart to Hold. This action resets the sweep to the start frequency.



Select channel 1: [Trigger] > Restart > Hold

Select channel 2: [Trigger] > Restart > Hold

Select channel 3: [Trigger] > Restart > Hold

Select channel 4: [Trigger] > Restart > Hold

Set PSG **Manual Mode** to Off

[Sweep/List] > More (1 of 2) > Manual Mode **Off** On

On the PNA, on all four channels, trigger to continuous.



Select channel 1: [Trigger] > Continuous

Select channel 2: [Trigger] > Continuous

Select channel 3: [Trigger] > Continuous

Select channel 4: [Trigger] > Continuous

Note

If you change any setting on the PNA that affects sweep time (IFBW, points), the sweep will be restarted and the sweep time modified, and therefore the PNA and PSG are no longer synchronized.

At this point, both instruments should be sweeping and you should be able to make a valid measurement. Make sure that the triggering hardware is connected, as shown in Figure 12, and that the 10 MHz references are locked.

Step 7: Measure

Connect the amplifier input to the combiner output and amplifier output to the network analyzer port 2. Channels 1 and 2 should show approximately the same power level, as one of the requirements of two-tone intermodulation testing is that the input power levels be the same. This power level should be the input power level plus the gain of the amplifier. Channels 3 and 4 should show values generally greater than 30 dB lower than channels 1 and 2, as channels 3 and 4 are displaying the level of the intermodulation distortion products.

In our example, channels 1 and 2 show approximately 0 dBm (–20 dBm input power, 20 dB amplifier gain). Channels 3 and 4 show approximately –40 dBm.

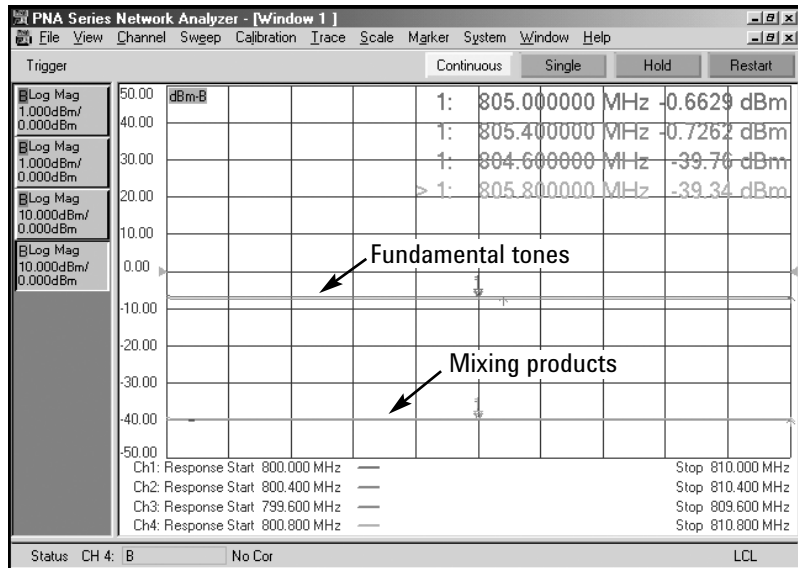

Figure 26. Measure swept intermodulation distortion products on the MW PNA.

The equation to calculate the third order intercept is:

$$IP3 \text{ (dBm)} = P(f_1) + 1/2 [P(f_1) - \max\{P(2f_2 - f_1), P(2f_1 - f_2)\}]$$

$$P(f_1) = \text{Output power} \approx 0 \text{ dBm in this example}$$

$\max\{P(2f_2 - f_1), P(2f_1 - f_2)\}$ is the worst-case reading between channels 3 and 4.

$$IP3 \text{ (dBm)} = -0.6 + 1/2 [-0.6 - (-39.3)] = +19 \text{ dBm}$$

The IP3 of this DUT is +19 dBm at 800 MHz, with –20 dBm input power.

Quick Reference on Swept IMD measurements

PNA Setup

Use four measurement channels making B receiver measurements

Source for all channels – fundamental tone frequency range (f_1)

Use frequency-offset mode ON for all channels

Channel 1, measuring fundamental tone: FOM setting, 0 offset

Channel 2, measuring second fundamental tone: FOM setting, $+\Delta$ offset

Channel 3, measuring low-side mixing products: FOM setting, $-\Delta$ offset

Channel 4, measuring high-side mixing products: FOM setting, $+2\Delta$ offset

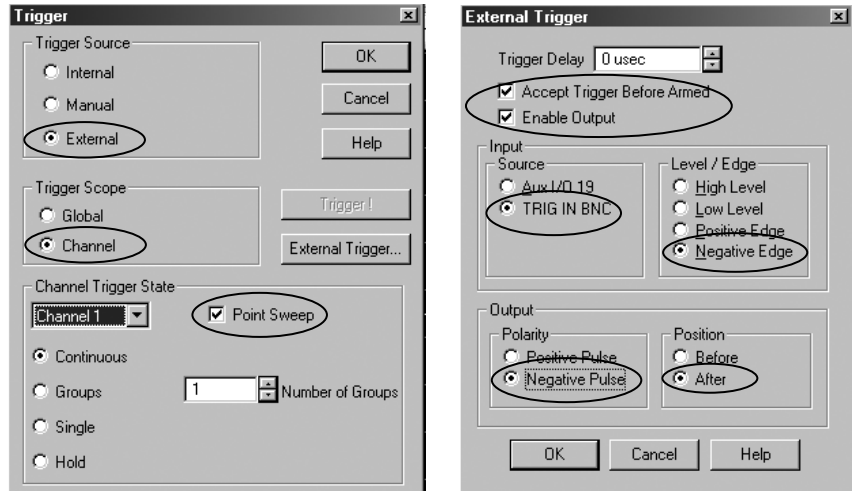

PSG Setup

PSG source setup for second fundamental frequency range ($f_2 = f_1 + \Delta$)

Sweep = stepped mode

Sweep Triggering = Free Run

Point Triggering = External

Trigger In/Out Polarity = Negative

Number of points = same as PNA

Synchronization procedure

Set PSG Manual Mode to ON

Set PNA Trigger to Restart, then Hold

Set PSG Manual Mode to OFF

Set PNA Trigger to Continuous

Technique B. One Channel, Basic Calibration

In this method, we benefit from the *CW Override* feature of the frequency-offset mode.

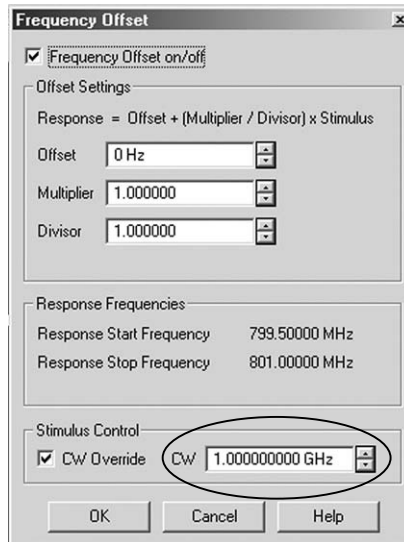

Figure 27. Use CW override for IMD measurements.

This allows the network analyzer source to reside at a CW frequency, while the receivers sweep a defined frequency span. So we set the source to the fundamental tone, and the receiver to sweep the range of the four tones: the two fundamental tones and the two mixing products.

The MW PNA stimulus can be set up in two ways. Technique B1 involves a segmented sweep, where only the four tones are measured. This method is very fast, as only four points are measured. It also ensures frequency accuracy, by specifying the exact frequencies that are measured.

Technique B2 involves a linear sweep, sweeping from $2f_2 - f_1$ to $2f_1 - f_2$. The network analyzer display appears similar to a spectrum analyzer display, shown in Figure 33, and it is an intuitive way of examining intermodulation distortion products. The calibration and measurement take some time, as enough points are needed to ensure that the desired tones are measured accurately.

Technique B1. One Channel, Basic Calibration

Step 1: Stimulus setup

[Preset]

[Power] > Level > -20 > [Enter]

From the menu item **Sweep**, select **Sweep Type...**, and then **Segment Sweep**. Select "Show Table" and define the segment table, as shown in Figure 28.

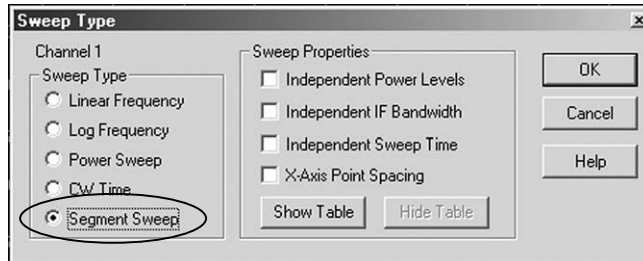

Figure 28. Use segment mode to sweep only desired frequency points.

In the segment table, enter the four frequencies of interest: the two fundamental tones and the low and high-side mixing products.

	STATE	START	STOP	POINTS
1	ON	799.500000 MHz	799.500000 MHz	1
2	ON	800.000000 MHz	800.000000 MHz	1
3	ON	800.500000 MHz	800.500000 MHz	1
4	ON	801.000000 MHz	801.000000 MHz	1

Status CH 1: B No Cor

Figure 29. Define frequency segments to measure fundamental and mixing product tones.

Configure the channel to make a B receiver measurement. Select menu item **Trace > Measure > Measure > More Types ... Select B > Unselect Ratioed Type...**

Step 2: Calibrate

Source-power calibration

Connect a power sensor to the output of the combiner and perform a source power calibration. Make sure that on the PSG signal source, the RF power is off. From the menu select:

Calibration > Power Calibration ... > Source Power Cal

Select **Take Cal Sweep**

Once the calibration is complete, you should see the **Src Pwr Cal** indicator on the status bar.

Receiver calibration

Make a through connection between MW PNA port 1 and 2 and perform a receiver calibration on all channels. For a through connection, MW PNA port 1 is connected to the input of the combiner, and the output of the combiner is connected to MW PNA port 2. Again, make sure the PSG signal generator RF power is off.

Calibration > Power Calibration ... > Receiver Power Cal > Take Cal Sweep

Now the frequency range covering the four tones is calibrated.

Step 3: Measure

Select frequency-offset mode and activate it, with a zero offset, x1 multiplier and divisor, and activate the *Stimulus CW override* feature. This setting establishes a fixed (CW) stimulus frequency while measuring the response over a swept frequency range.

Select menu item **Channel > Frequency Offset...** Set the CW frequency to 800 MHz, the fundamental frequency. Note the receiver frequency ("Response Frequencies") covers the four tones.

Note

If the CW override frequency is not initially 800 MHz, the receiver cal may be turned off, because it will be invalid for the default frequency of 1 GHz. In such a case, set up the frequency offset-mode as described above first, and accept the receiver cal getting turned off. Then turn frequency-offset mode off. Turn receiver cal back on, using the menu item, **Calibration > Power Calibration ... > Receiver Power Cal, Receiver Power Correction ON/off**. Next turn frequency-offset mode back on.

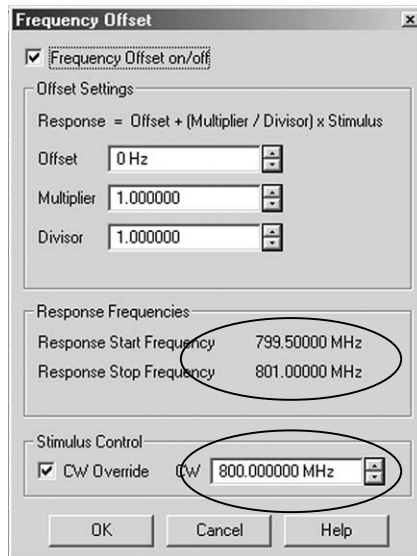

Figure 30. Use the MW PNA's CW override feature.

Once you have a valid interpolated source-power cal and receiver cal, you can measure the device. Connect the amplifier input to the combiner output and amplifier output to the MW PNA port 2. Turn on the PSG signal generator to 800.5 MHz, and examine the display. Place four markers on the four tones and calculate the IMD product.

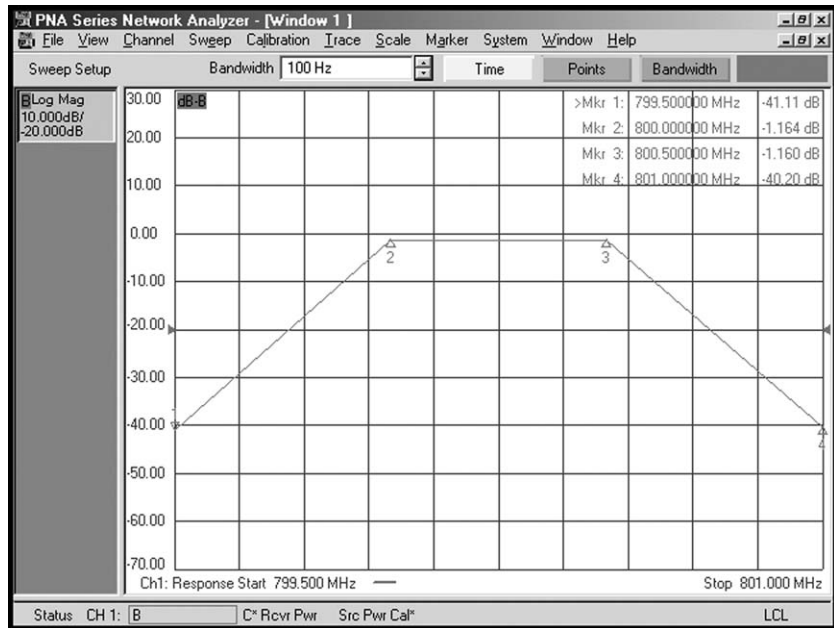

Figure 31. Measure the two fundamental and two mixing-product tones.

The equation to calculate the third order intercept is:

$$IP3 \text{ (dBm)} = P(f_1) + 1/2 [P(f_1) - \max\{P(2f_2 - f_1), P(2f_1 - f_2)\}]$$

$P(f_1)$ = Output power ≈ 0 dBm in this example

$\max\{P(2f_2 - f_1), P(2f_1 - f_2)\}$ is the worst case reading between markers 3 and 4.
Worst case is the larger value in dB.

$$IP3 \text{ (dBm)} = -1.258 + 1/2(-1.258 - (-42.03)) = 19.13 \text{ dBm}$$

The measured IP3 of this DUT is +19.13 dBm at 800 MHz, with -20 dBm input power.

Technique B2. One Channel, Linear Sweep Basic Calibration

Step 1: Stimulus setup

[Preset]

[Start/Center] > Start > 798 [M/μ] > Stop > 803 [M/μ]

[Power] > Level > -20 > [Enter]

[Sweep Setup] > Points > 401 [Enter]

For measurement accuracy, select a combination of span and number of points such that the frequencies of interest are actually measured, versus interpolated. Here we want to measure the four tones: 799.5, 800, 800.5 and 801 MHz. With a span of 5 MHz and 401 points, we will be able to exactly measure the desired tones.

Description	Symbol	Example
Fundamental tone	f_1	800 MHz
PNA start frequency	f_{start}	798 MHz
PNA stop frequency	f_{stop}	803 MHz
PNA number of points	N	401
PNA frequency spacing	$f_{\text{sp}} = (f_{\text{stop}} - f_{\text{start}}) / (N-1)$	5 MHz / 400 = 0.0125 MHz
nth point required for desired tone f	$n = (f - f_{\text{start}}) / f_{\text{sp}}$	
Low-side mixing product	$2f_1 - f_2$	799.5 MHz = $(0.0125 * 120) + 798$
Fundamental tone f_1	f_1	800 MHz = $(0.0125 * 160) + 798$
Fundamental tone f_2	f_2	800.5 MHz = $(0.0125 * 200) + 798$
High-side mixing product	$2f_2 - f_1$	801 MHz = $(0.0125 * 240) + 798$

Configure the channel to make a B receiver measurement. Select menu item

Trace > Measure > Measure > More Types ... Select B > Unselect Ratioed Type...

Step 2: Calibrate

Source-power calibration

Connect a power sensor to the output of the combiner and perform a source-power calibration. Make sure that RF power is off on the PSG signal source which supplies the second tone. From the menu select:

Calibration > Power Calibration ... > Source Power Cal

Select **Take Cal Sweep**

Once the calibration is complete, you should see the **Src Pwr Cal** indicator on the status bar.

Receiver calibration

Make a through connection between MW PNA port 1 and 2 and perform a receiver calibration on all channels. For a through connection, MW PNA port 1 is connected to the input of the combiner, and the output of the combiner is connected to MW PNA port 2. Again, make sure the PSG signal generator RF power is off.

Calibration > Power Calibration ... > Receiver Power Cal > Take Cal Sweep

Now the frequency range covering the four tones is calibrated.

Step 3: Measure

Select frequency-offset mode and activate it, with a zero offset, x1 multiplier and divisor, and activate the *Stimulus CW override* feature. This setting establishes a fixed (CW) stimulus frequency while measuring the Response over a swept frequency range. Select menu item **Channel > Frequency Offset...** Set the CW frequency to 800 MHz, the fundamental frequency. Note the receiver frequency ("Response Frequencies") covers the four tones.

Note

If the CW override frequency is not initially 800 MHz, the receiver cal may be turned off, because it will be invalid for the default frequency of 1 GHz. In such a case, set up the frequency offset-mode as described above first, and accept the receiver cal getting turned off. Then turn frequency-offset mode off. Turn receiver cal back on, using the menu item, **Calibration > Power Calibration ... > Receiver Power Cal, Receiver Power Correction ON/off.** Next turn frequency-offset mode back on.

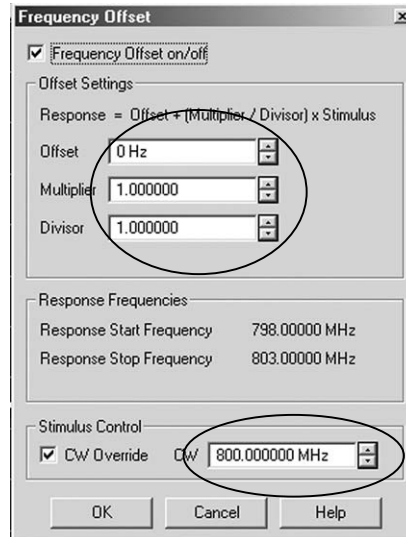

Figure 32. Use the MW PNA's CW override feature.

Once you have a valid interpolated source-power cal and receiver cal, connect the amplifier. Connect the amplifier input to the combiner output and amplifier output to the MW PNA port 2. Turn on the PSG signal generator to 800.5 MHz, and examine the display. Place four markers on the four tones. Use the *discrete marker* capability to ensure that the actual tones that you want to measure are desired. A slight offset in frequency can result in large measurement errors, so frequency accuracy is very important.

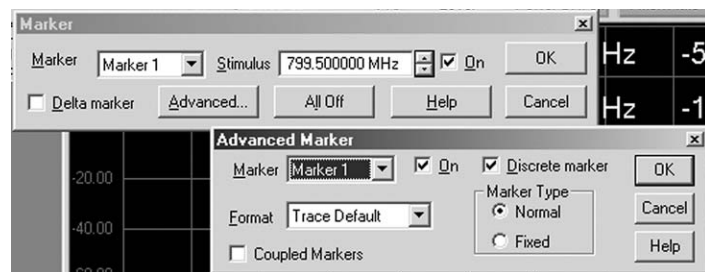

Figure 33. "Discrete markers" allow you to place markers on measured tones.

Once the markers have been placed, you can calculate the IMD.

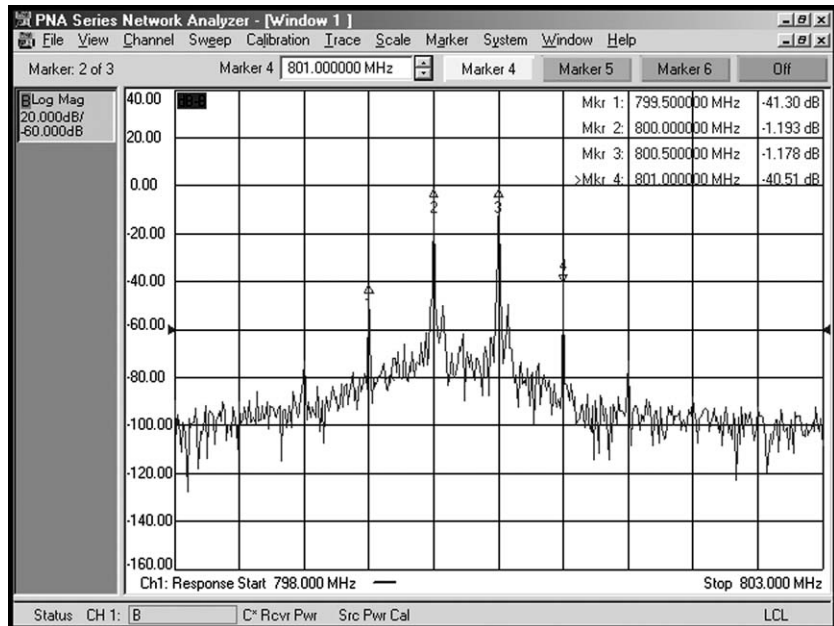

Figure 34. Measure the two fundamental and two mixing-product tones.

The equation to calculate the third order intercept is:

$$IP3 \text{ (dBm)} = P(f_1) + 1/2 [P(f_1) - \max\{P(2f_2 - f_1), P(2f_1 - f_2)\}]$$

$P(f_1)$ = Output power ≈ -1.2 dBm in this example

$\max\{P(2f_2 - f_1), P(2f_1 - f_2)\}$ is the worst case reading between markers 3 and 4. Worst case is the larger value in dB.

$$IP3 \text{ (dBm)} = -1.193 + 1/2(-1.193 - (-41.30)) = 18.86 \text{ dBm}$$

The measured IP3 of this DUT is +18.86 dBm at 800 MHz, with -20 dBm input power.

For reference, the images below show the same measurement on an Agilent PSA spectrum analyzer.

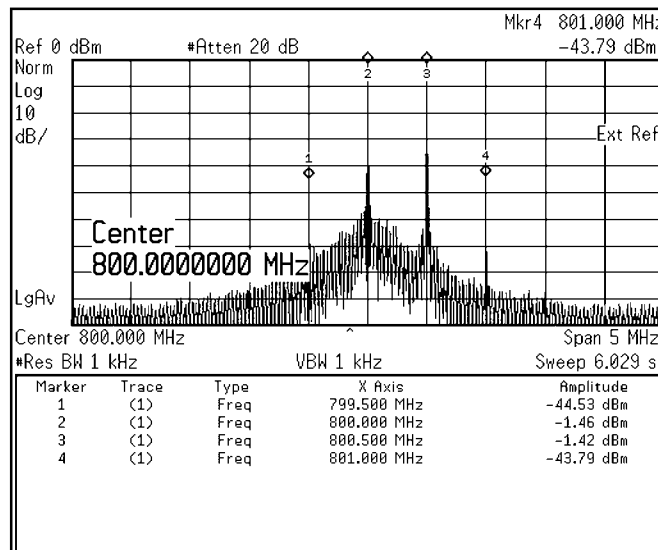

Figure 35. Display of the four tones on a spectrum analyzer.

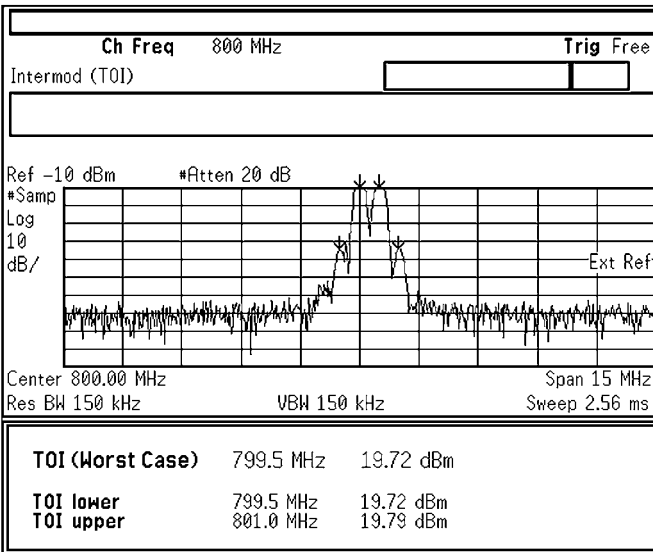

Figure 36. Using the *Intermod Measure* functionality of the spectrum analyzer to calculate TOI.

Technique C. Four Channels Scalar-Mixer Calibration

Technique C is similar to technique A, except for calibration. The harmonic measurement discussed in Application Note, 1208-9, covers harmonic testing with technique C. A similar calibration methodology can be applied to intermodulation measurements.

Appendix A

The MW PNA has four mixer-based receivers which have an IF of 8.33 MHz, so the local oscillator (LO) of the MW PNA generates a signal that is offset 8.33 MHz from the receiver signal. The LO is higher in frequency than the measured tone by design. If you are measuring the low-side tone or the low-side mixing product, the MW PNA's LO can mix with the high-side tone or high-side mixing product, and generate an IF of 8.33 MHz. This new mixing product will be measured by the analyzer and result in measurement error.

This issue does not exist when measuring the high-side tone or high-side mixing product, since the tones that could result in an IF of 8.33 MHz have low power levels and are insignificant. It also will not be a problem if the tone spacing is far less than 8.33 MHz.

Therefore, for tone spacing close to 8.33 MHz, we recommend that when measuring low-side tones or low-side mixing products, shift the receiver offset frequency by -16.667 MHz. This will shift the MW PNA's LO and eliminate most of the problem. The VNA source frequency is not changed, but the receiver is now offset by 16.667 MHz. We are taking advantage of the fact that the VNA first converter responds to the image frequency, as well as the main tone, even though it is a tuned receiver. Figure 37, shown on the next page, represents the above behavior for the low-side mixing product $2f_1 - f_2$ tone. The table below shows the settings necessary for making an IMD measurement, with tone spacings close to 8.33 MHz.

Step	Goal	Source frequency	FOM Offset (Multiplier x1)	Receiver frequency
1	Setup measurement for calibration	Ch 1: f_1 Ch 2: $f_1 \rightarrow f_2$ Ch 3: $2f_1 - f_2 \rightarrow f_1$ Ch 4: $f_1 \rightarrow 2f_2 - f_1$	0 0 0 0	Ch 1: f_1 Ch 2: $f_1 \rightarrow f_2$ Ch 3: $2f_1 - f_2 \rightarrow f_1$ Ch 4: $f_1 \rightarrow 2f_2 - f_1$
2	Source-power calibration			
3	Receiver calibration			
4	Modify the input frequencies of all channels to f_1 .	Ch 1: f_1 Ch 2: f_1 Ch 3: f_1 Ch 4: f_1	0 0 0 0	Ch 1: f_1 Ch 2: f_1 Ch 3: f_1 Ch 4: f_1
5	Modify the FOM offset on all channels to tune receiver to appropriate frequency.	Ch 1: f_1 Ch 2: f_1 Ch 3: f_1 Ch 4: f_1	-16.667 MHz Δf $-\Delta f - 16.667$ MHz $2x\Delta f$	Ch 1: $f_1 - 16.667$ MHz Ch 2: f_2 Ch 3: $2f_1 - f_2 - 16.667$ MHz Ch 4: $2f_2 - f_1$

An example of a worst case scenario – tone spacing of exactly 8.33 MHz. When measuring the low-side mixing product of $2f_1 - f_2$, the LO will reside at $2f_1 - f_2 + \text{LO}$. If $\Delta = 8.33$ MHz, the LO will reside at the same frequency as f_1 . Then the LO will mix with f_2 , producing an IF of 8.33 MHz, and result in a large error.

Setup

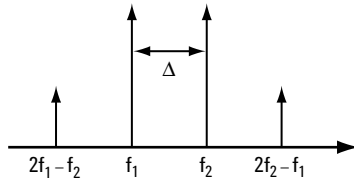

Desired tone

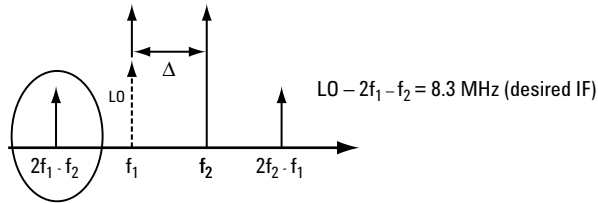

Measurement error

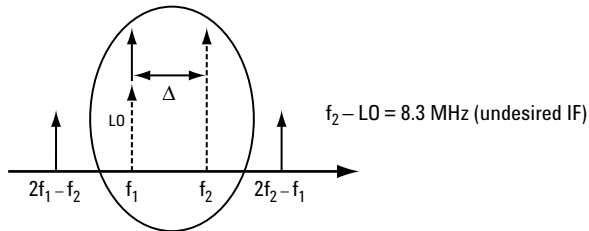

The solution is very simple. Tune the receiver to measure $2f_1 - f_2 - 16.67$ MHz, and thereby shift the LO by 16.67 MHz. The tone $2f_1 - f_2$ is still measured, because it is the image of $2f_1 - f_2 - 16.67$ MHz.

Solution

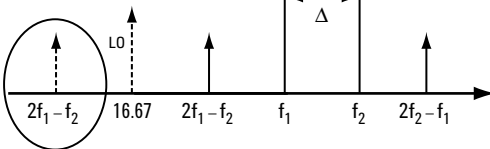

Figure 37. Description of the measurement of the low-side tone or low-side mixing product, if tone spacings are close to 8.33 MHz.

References

Microwave PNA Series Network Analyzer, Application Note 1408-7,
Amplifier Linear and Gain Compression Measurements,
Literature number 5988-8644EN

Microwave PNA Series Network Analyzer, Application Note 1408-8,
Amplifier Swept Harmonic Measurements, Literature number 5988-9473EN

Web Resources

For additional literature and product information about the Agilent PNA Series visit:
www.agilent.com/find/pna

For additional information about Agilent electronic calibration (ECal) modules visit:
www.agilent.com/find/ecal



Agilent Email Updates

www.agilent.com/find/emailupdates

Get the latest information on the products and applications you select.



Agilent Direct

www.agilent.com/find/agilentdirect

Quickly choose and use your test equipment solutions with confidence.



www.agilent.com/find/open

Agilent Open simplifies the process of connecting and programming test systems to help engineers design, validate and manufacture electronic products. Agilent offers open connectivity for a broad range of system-ready instruments, open industry software, PC-standard I/O and global support, which are combined to more easily integrate test system development.

www.agilent.com

Agilent Technologies' Test and Measurement Support, Services, and Assistance

Agilent Technologies aims to maximize the value you receive, while minimizing your risk and problems. We strive to ensure that you get the test and measurement capabilities you paid for and obtain the support you need. Our extensive support resources and services can help you choose the right Agilent products for your applications and apply them successfully. Every instrument and system we sell has a global warranty. Two concepts underlie Agilent's overall support policy: "Our Promise" and "Your Advantage."

Our Promise

Our Promise means your Agilent test and measurement equipment will meet its advertised performance and functionality. When you are choosing new equipment, we will help you with product information, including realistic performance specifications and practical recommendations from experienced test engineers. When you receive your new Agilent equipment, we can help verify that it works properly and help with initial product operation.

Your Advantage

Your Advantage means that Agilent offers a wide range of additional expert test and measurement services, which you can purchase according to your unique technical and business needs. Solve problems efficiently and gain a competitive edge by contracting with us for calibration, extra-cost upgrades, out-of-warranty repairs, and onsite education and training, as well as design, system integration, project management, and other professional engineering services. Experienced Agilent engineers and technicians worldwide can help you maximize your productivity, optimize the return on investment of your Agilent instruments and systems, and obtain dependable measurement accuracy for the life of those products.

For more information on Agilent Technologies' products, applications or services, please contact your local Agilent office.

Phone or Fax

United States:

(tel) 800 829 4444
(fax) 800 829 4433

Canada:

(tel) 877 894 4414
(fax) 800 746 4866

China:

(tel) 800 810 0189
(fax) 800 820 2816

Europe:

(tel) 31 20 547 2111

Japan:

(tel) (81) 426 56 7832
(fax) (81) 426 56 7840

Korea:

(tel) (080) 769 0800
(fax) (080) 769 0900

Latin America:

(tel) (305) 269 7500

Taiwan:

(tel) 0800 047 866
(fax) 0800 286 331

Other Asia Pacific Countries:

(tel) (65) 6375 8100
(fax) (65) 6755 0042

Email: tm_ap@agilent.com

Contacts revised: 09/26/05

**The complete list is available at:
www.agilent.com/find/contactus**

Product specifications and descriptions in this document subject to change without notice.

© Agilent Technologies, Inc. 2003, 2004, 2006
Printed in USA, August 8, 2006
5988-9474EN

Windows® is a U.S. registered trademark of the Microsoft Corporation.



Agilent Technologies