

Agilent PNA Microwave Network Analyzers

Application Note 1408-8

Amplifier Swept-Harmonic Measurements

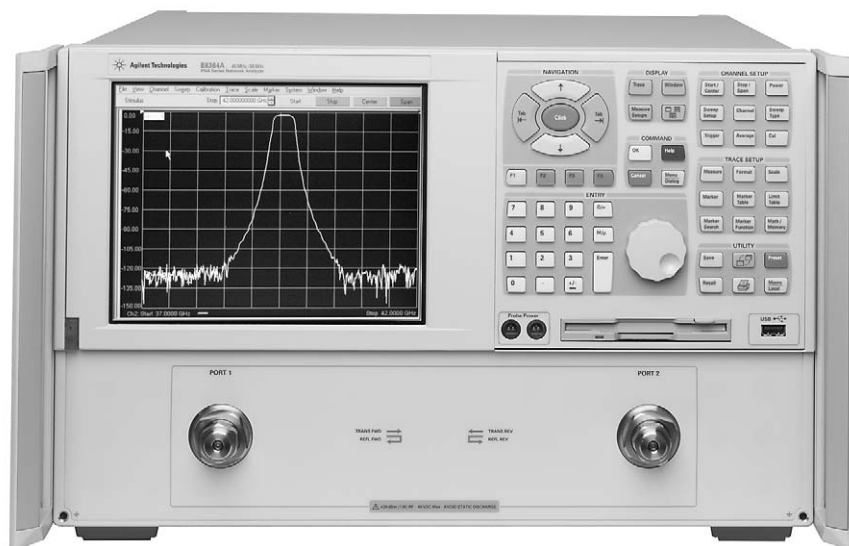
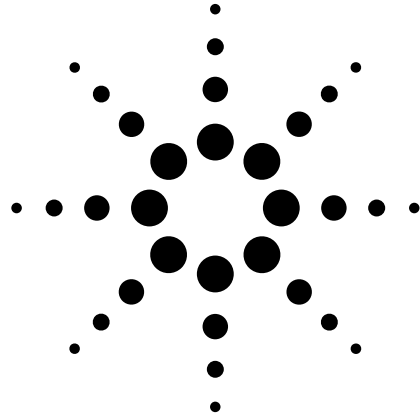

Agilent Technologies

Table of Contents

Introduction	2
Swept-Harmonic Measurements	2
Test Methodology Alternatives	3
Technique A1. Source Harmonics Not Filtered, Basic Calibration	3
Technique A2. Source Harmonics Filtered, Basic Calibration	8
Technique B. Source Harmonics Not Filtered, Scalar-Mixer Calibration	12
References	16

Note: The step-by-step procedures in this application note were written for PNA (836xA/B) and PNA-L (N5230A) network analyzers with firmware revision A.04.06. If you have a PNA or PNA-L with a different firmware revision, the step-by-step procedures or screenshots may vary. The concepts and general guidelines still apply.

Introduction

This application note covers testing of an amplifier’s harmonics, using the microwave (MW) PNA Series of vector network analyzers. Linear parameters, such as gain and return loss, are covered in Agilent Application Note 1408-7. Intermodulation distortion is covered in Agilent Application Note 1408-9.

Amplifiers are a fundamental building block of microwave systems, and characterizing the performance of amplifiers is a critical factor in the design process. Network analyzers are traditionally used for linear amplifier measurements, while spectrum analyzers are used for nonlinear measurements such as harmonics and intermodulation distortion. However, many modern network analyzers, including the Agilent MW PNA Series, can be used for nonlinear measurements as well, by enabling the frequency-offset functionality.

Most amplifier test systems include a network analyzer for reflection measurements. If the network analyzer can also be used for nonlinear measurements, then capital equipment costs are reduced. The purpose of this application note is to demonstrate how to use the Agilent MW PNA Series network analyzers to measure amplifier harmonics.

Swept-Harmonic Measurements

In this application note, the device-under-test (DUT) is an amplifier with the following specifications.

Frequency range	1.4 to 2.4 GHz
Minimum small signal gain	10 dB
Input SWR	1.5:1
Output SWR	2.0:1
Output 1 dB compression	+3 dBm
Third order intercept	+14 dBm

Note

MW PNA [front-panel keys] are shown in brackets, while the **softkeys** are displayed in bold; “menu item” refers to the Windows® drop down menus.

Due to inherent nonlinearities, an amplifier generates additional responses, called harmonics, at integer multiples of the stimulus frequency, or harmonics. Harmonic distortion is defined as the difference in absolute power between the fundamental tone and the harmonic response, expressed in dBc, for a specified input or output power.

Traditionally, harmonic measurements are made with a spectrum analyzer at several continuous wave (CW) frequencies. Many frequencies must be tested for complete characterization, which can dramatically increase test time. With the MW PNA Series frequency-offset mode (FOM), you can make swept frequency harmonic measurements. This capability provides a real-time update of the measured harmonic response versus frequency, very fast. The network analyzer source is set to the input frequency, while the receivers are tuned to the desired harmonic (2nd, 3rd,...). Higher harmonics (4th, 5th,...) can also be measured, as long as the maximum frequency does not exceed that of the analyzer. MW PNA Series analyzers are available in 20, 40, 50, and 67 GHz models.

With the MW PNA Series, the power of the fundamental tone is measured on one channel, while the harmonic response is measured on another channel. In both cases, the source is set to the input frequency.

Test Method Alternatives

	Technique A1 Source harmonics not filtered, basic calibration	Technique A2 Source harmonics filtered, basic calibration	Technique B Source harmonics not filtered, scalar mixer calibration
Network analyzer options	Frequency-offset mode (Option 080)	Frequency-offset mode (Option 080)	Frequency-offset mode (Option 080) and frequency converter application (Option 083)
Description	Multiple channels are used to measure the desired harmonics. Channel 1 is configured to measure the fundamental f_1 , channel 2 to measure $2f_1$, channel 3 to measure $3f_1$, and ...		
Calibration	One source-power calibration and one receiver calibration	Two source-power calibrations and one receiver calibration	Scalar-mixer calibration (SMC) provides match-corrected power measurements
Advantages of each technique	Simplest of techniques	Source harmonics are filtered, therefore measurement is more accurate	If the device-under-test has perfect match, there is no difference between the accuracy of techniques A1, A2 and B. The worse the match of the device, the more advantage there is to using technique B versus A1 and A2
Disadvantages of each technique	Source harmonics not filtered Mismatch errors not corrected	Mismatch errors not corrected	Source harmonics cannot be filtered using this method

Technique A1. Source Harmonics Not Filtered, Basic Calibration

Step 1: Setup

The hardware setup for method 1 is shown in Figure 1. Figure 2 shows the necessary steps to measure the 2nd and 3rd harmonics of an amplifier, using the MW PNA Series.

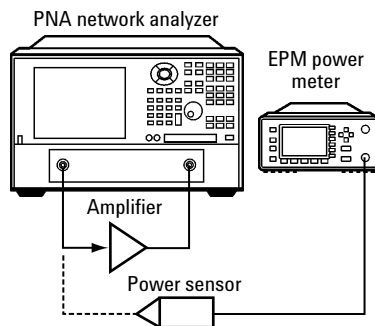

Figure 1. Setup for measuring amplifier harmonics without filtering of the MW PNA source.

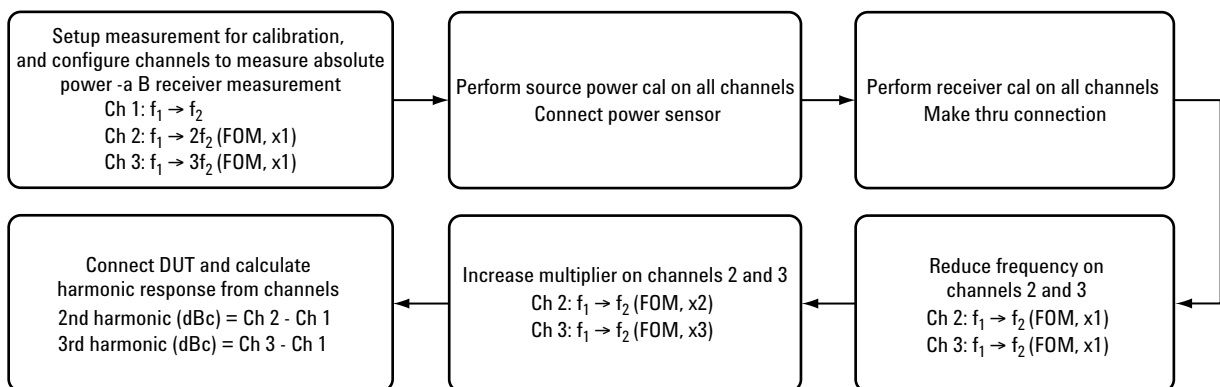

Figure 2. Procedure for measuring harmonics ($f_1 \rightarrow f_2$ indicates a frequency sweep from f_1 to f_2).

Channels 1, 2, and 3 will be used to measure the fundamental, second, and third harmonic respectively. Initially we will set up the channels in a way that we can perform the calibration. After calibration, we will modify the stimulus to measure the actual harmonics.

Channel 1: 1.4 to 2.4 GHz, -20 dBm

Channel 2: 1.4 to 4.8 GHz, -20 dBm, frequency-offset mode on, 1x multiplier

Channel 3: 1.4 to 7.2 GHz, -20 dBm, frequency-offset mode on, 1x multiplier

[Preset]

Configure channel 1

Menu item **Trace > Measure > Measure ... > More Types ... > B**, unselect **Ratioed Type**

[Start/Center] > **Start 1.4 [G/n] > Stop 2.4 [G/n]**

[Power] > **Level -20 [Enter]**

Configure channel 2

Menu item **Trace > New Trace... > More Types ... > B**, unselect **Ratioed Type**, select **Channel 2**

[Start/Center] > **Start 1.4 [G/n] > Stop 4.8 [G/n]**

[Power] > **Level -20 [Enter]**

Configure channel 3

Menu item **Trace > New Trace... > More Types ... > B**, unselect **Ratioed Type**, select **Channel 3**

[Start/Center] > **Start 1.4 [G/n] > Stop 7.2 [G/n]**

[Power] > **Level -20 [Enter]**

On channels 2 and 3, turn on frequency-offset mode, with a zero offset and x1 multiplier. From the menu item **Channel**, select **Frequency Offset ...**

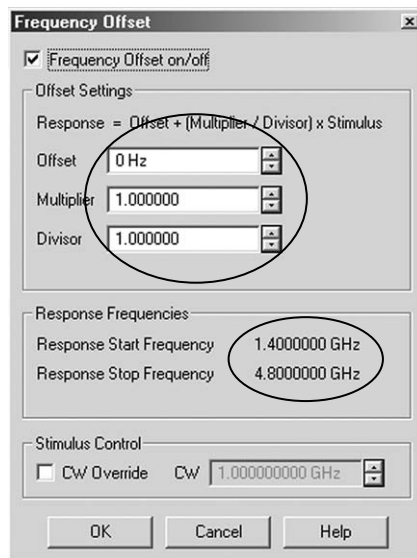

Figure 3. Initially configure channel 2 frequency-offset mode for calibration.

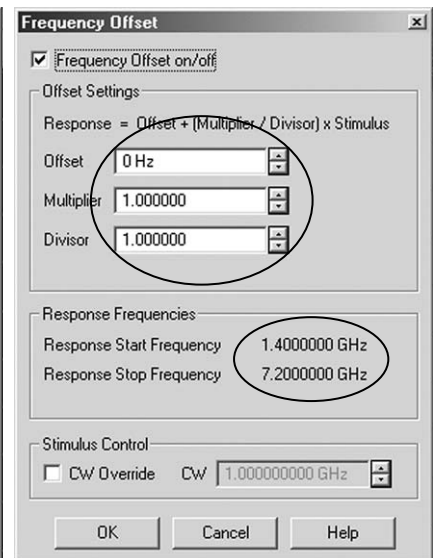

Figure 4. Initially configure channel 3 frequency-offset mode for calibration.

In Figure 5, observe that the frequency indicator of channel 1 differs from channel 2 and channel 3. It differs because channel 1 is in standard linear-sweep mode, while channel 2 and 3 are in frequency-offset mode.



Figure 5. The frequency range indicates whether the analyzer is operating in standard mode or frequency-offset mode.

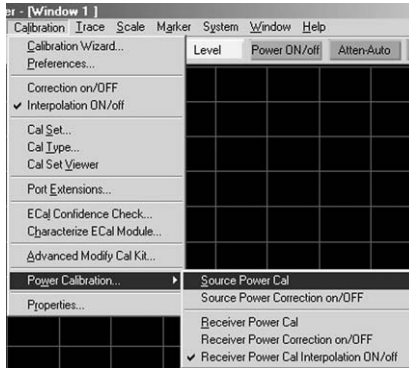

Figure 6. Source-power calibration provides a basis for receiver calibration.

Note

The three-channel source-power calibration can either be performed via the method described in the previous paragraph, or an alternate route described below that depends on interpolation. Perform a wide band (f_1 to $3f_2$) source power cal with many points (1601+) on channel 1. Then take advantage of the "copy channel" feature to copy channel 1 to channels 2 and 3, and reduce the frequency range to the desired setting. The calibration will be interpolated.

Note

The calibration steps should be performed in frequency-offset mode, with a multiplier of 1, instead of standard linear frequency sweep. Even though the frequencies that are swept are the same, the phase locking process of the analyzer differs in frequency-offset mode, compared to standard linear sweep. Therefore, the calibration is more accurate if it is performed in frequency-offset mode.

Step 2: Calibrate

Source-power calibration

Perform a source-power calibration on all three channels, by connecting a power sensor to the test port.

Select channel 1: menu item **Calibration > Power Calibration ... > Source Power Cal**

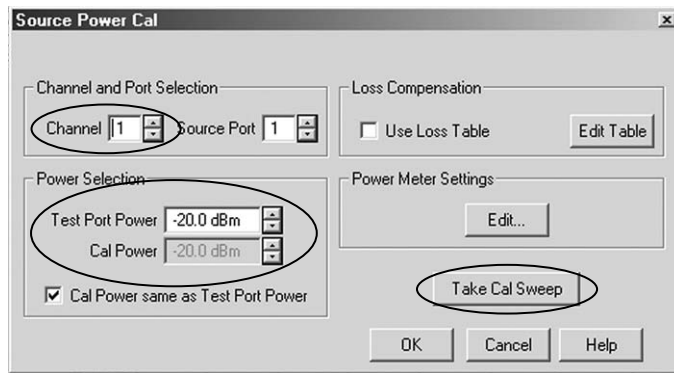

Figure 7. Select the appropriate channel in the Source Cal dialog box.

Select channel 2: menu item **Calibration > Power Calibration ... > Source Power Cal**

Select channel 3: menu item **Calibration > Power Calibration ... > Source Power Cal**

Once the calibration is done, note the "Src Pwr Cal" indicator on the status bar.

Receiver calibration

Perform a receiver calibration on all three channels, by making a thru connection. A receiver calibration is essentially a normalization, similar to a response calibration. The difference between a receiver cal and a response cal is that a receiver cal is performed on the B receiver and provides absolute accuracy, whereas a response cal is performed on an S_{21} measurement and provides relative accuracy. An accurate receiver cal starts with a source power cal as the reference.

Select channel 1: menu item **Calibration > Power Calibration ... > Receiver Cal > Take Cal Sweep**

Select channel 2: menu item **Calibration > Power Calibration ... > Receiver Cal > Take Cal Sweep**

Select channel 3: menu item **Calibration > Power Calibration ... > Receiver Cal > Take Cal Sweep**

Step 3: Modify settings

Modify stimulus

On channels 2 and 3, reduce the frequency range to the fundamental range of 1.4 GHz to 2.4 GHz. Reduce the frequency range such that the calibration remains valid at all times. The source and receiver calibrations will be interpolated.

[Start/Center]

Channel 2: **Stop > 2.4 [G/n]**

Channel 3: **Stop > 2.4 [G/n]**

Modify frequency-offset settings

Modify frequency-offset mode settings to measure the appropriate response.

Channel 1: Leave as is, to measure f_1 from 1.4 GHz to 2.4 GHz.

Channel 2: Setup to measure second harmonic from 2.8 GHz to 4.8 GHz. Use a multiplier of x2.

Channel 3: Setup to measure third harmonic, from 4.2 GHz to 7.2 GHz. Use a multiplier of x3. Menu item **Channel > Frequency-offset ...**

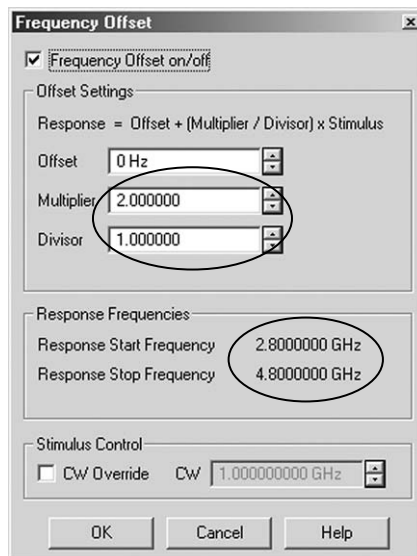

Figure 8. Configure the frequency-offset mode setting to measure the 2nd harmonic.

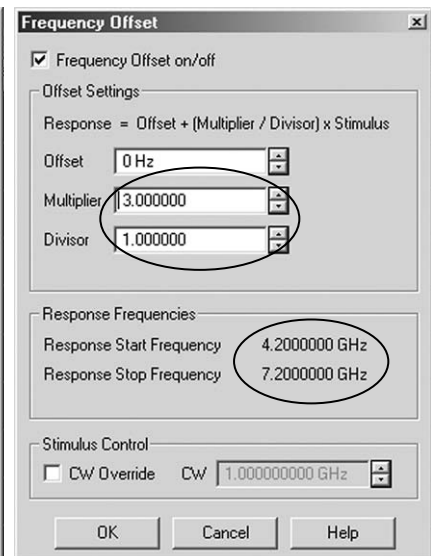

Figure 9. Configure the frequency-offset mode setting to measure the 3rd harmonic.

Step 4: Measure

Connect DUT and calculate the harmonic response

Next connect the amplifier and make the measurement. If you set up markers on channels 1, 2, and 3, and examine the difference between the values, you get the dBc value of the harmonic. Make sure you set the markers to the appropriate stimulus. Channel 2 markers should be set to twice the frequency of channel 1 markers. Channel 3 markers should be set to three times the frequency of channel 1 markers.

Channel 1: **[Marker] > Marker 1 > 2 [G/n]**

Channel 2: **[Marker] > Marker 1 > 4 [G/n]**

Channel 3: **[Marker] > Marker 1 > 6 [G/n]**

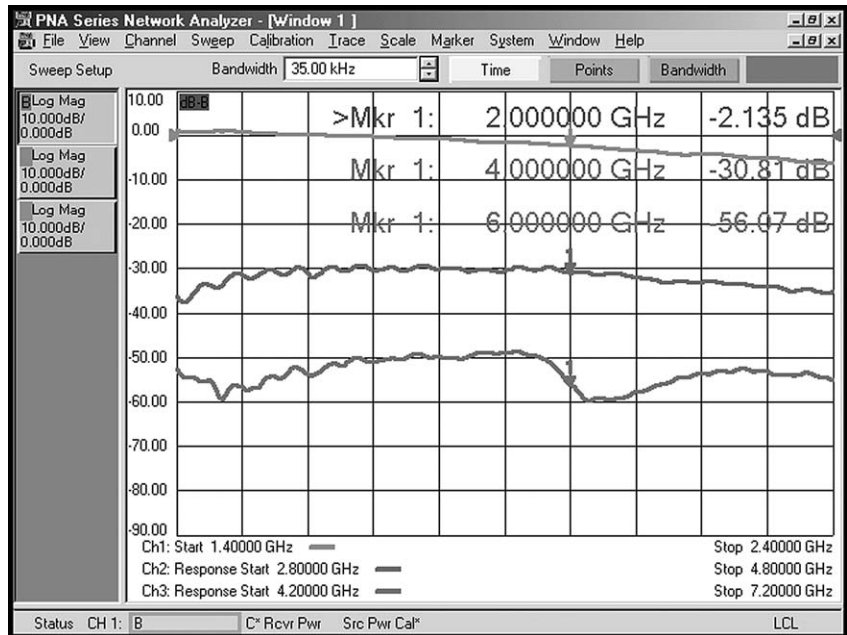

Figure 10. Use the MW PNA Series to measure the 2nd and 3rd harmonic of amplifiers.

In this example, the second harmonic is approximately 28 dB lower than the fundamental ($-30.81 - -2.135$). The third harmonic is approximately 54 dB lower than the fundamental ($-56.07 - -2.135$).

Note

You can make this measurement using the data to memory functionality of the MW PNA, and then display the harmonics as data-memory. Be sure to use the same number of points for the measurements. You will also need to modify the stimulus setting between measuring the fundamental and the harmonics. The benefit of using the data-memory capability is that the harmonic distortion value is displayed and you do not need to manually perform the subtraction. The downside is that the main gain trace is a memory trace and thus not "live." So if any factor, such as tuning or drift varies the performance of the amplifier, the harmonic performance will register the change, while the gain remains fixed.

If you perform the above measurement without the amplifier, with a simple through connection, you will measure the harmonics of the network analyzer source. This will indicate the level of error due to the network analyzer hardware. The four traces on Figure 11 show the MW PNA source 2nd and 3rd harmonic, and the amplifier's 2nd and 3rd harmonic.

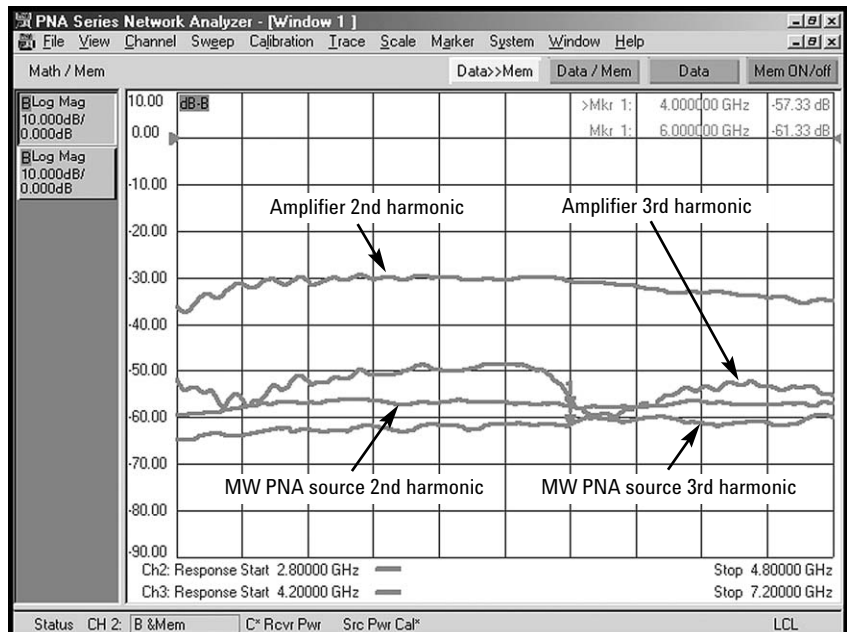

Figure 11. A comparison of the MW PNA source harmonics to the amplifier harmonics.

In order to reduce or mostly eliminate this measurement error, the source harmonics can be filtered. The next section describes the calibration and test methodology, using a filter on the input of the amplifier to filter the source harmonics. See Figure 17 for an image similar to Figure 11, with the exception that the source harmonics have been filtered. Note the scale difference between the two figures.

Technique A2. Source Harmonics Filtered, Basic Calibration

The MW PNA source generates its own harmonics (< 23 dBc typical). For accurate harmonics measurement, the source harmonics must be filtered. The level of these additional harmonics affects the range and uncertainty of harmonic measurements. The procedure in this section describes how to measure amplifier harmonics, while filtering out the source harmonics at the same time. This method still depends on the basic frequency-offset mode capability of the MW PNA.

There are two calibration steps, one without the filter, and one with the filter. The calibration without the filter is used to calibrate the receiver power level, while the calibration with the filter is used to calibrate the source output power.

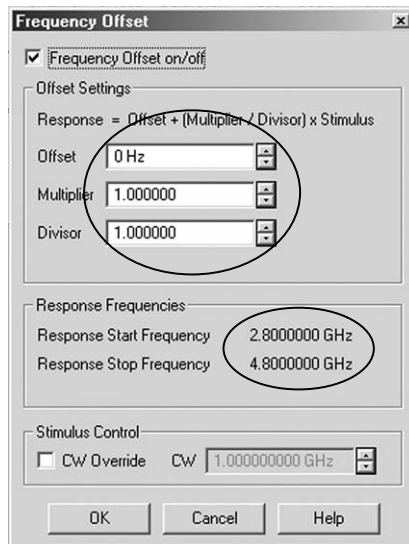

Figure 12. Initially configure channel 2 frequency-offset mode for calibration.

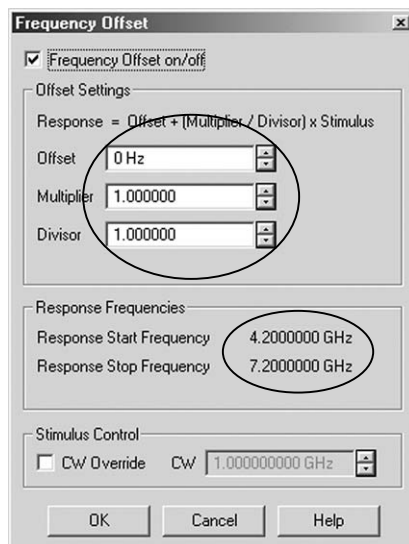

Figure 13. Initially configure channel 3 frequency-offset mode for calibration.

Step 1: Initial setup without filter – receiver calibration

Initially configure the test system setup as shown in Figure 1, without a filter. Channels 1, 2, and 3 will be used to measure the fundamental, second, and third harmonic respectively. Therefore we will calibrate the receivers in the fundamental, second, and third harmonic frequency range.

Channel 1: 1.4 to 2.4 GHz, –20 dBm

Channel 2: 2.8 to 4.8 GHz, –20 dBm, frequency-offset mode on, 1x multiplier

Channel 3: 4.2 to 7.2 GHz, –20 dBm, frequency-offset mode on, 1x multiplier

[Preset]

Configure channel 1

Menu item **Trace > Measure > Measure ... > More Types ... > B**, unselect **Ratioed Type** [Start/Center] > Start 1.4 [G/n] > Stop 2.4 [G/n]

[Power] > Level –20 [Enter]

Configure channel 2

Menu item **Trace > New Trace... > More Types ... > B**, unselect **Ratioed Type**, select **Channel 2**

[Start/Center] > Start 2.8 [G/n] > Stop 4.8 [G/n]

[Power] > Level –20 [Enter]

Configure channel 3

Menu item **Trace > New Trace... > More Types ... > B**, unselect **Ratioed Type**, select **Channel 3**

[Start/Center] > Start 4.2 [G/n] > Stop 7.2 [G/n]

[Power] > Level –20 [Enter]

On channels 2 and 3, turn on frequency-offset mode, with a zero offset and x1 multiplier. From the menu item **Channel**, select **Frequency Offset ...**

Source-power calibration

Perform a source-power calibration on all three channels, by connecting a power sensor to the output of port 2.

Select channel 1: menu item **Calibration > Power Calibration ... > Source Power Cal**

Select channel 2: menu item **Calibration > Power Calibration ... > Source Power Cal**

Select channel 3: menu item **Calibration > Power Calibration ... > Source Power Cal**

Once the calibration is done, note the “Src Pwr Cal” indicator on the status bar for all three channels.

Receiver calibration

Perform a receiver calibration on all three channels, by making a thru connection without the filter.

Select channel 1: menu item **Calibration > Power Calibration ... > Receiver Cal > Take Cal Sweep**

Select channel 2: menu item **Calibration > Power Calibration ... > Receiver Cal > Take Cal Sweep**

Select channel 3: menu item **Calibration > Power Calibration ... > Receiver Cal > Take Cal Sweep**

Now the network analyzer receiver is calibrated to measure the fundamental and harmonics.

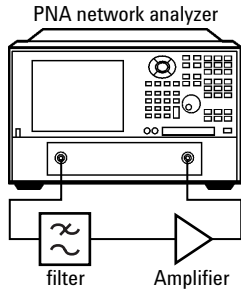

Figure 14. A filter is added to the MW PNA source output to filter source harmonics and improve measurement uncertainty.

Step 2: Connect filter and calibrate the source

The objective in this step is to calibrate the input power to the DUT, with the filter in place. So connect the filter to the output of port 1, or the source, and perform a source-power calibration at the output of the filter. The hardware setup is shown in Figure 14. Figure 15 shows the procedure for making this measurement.

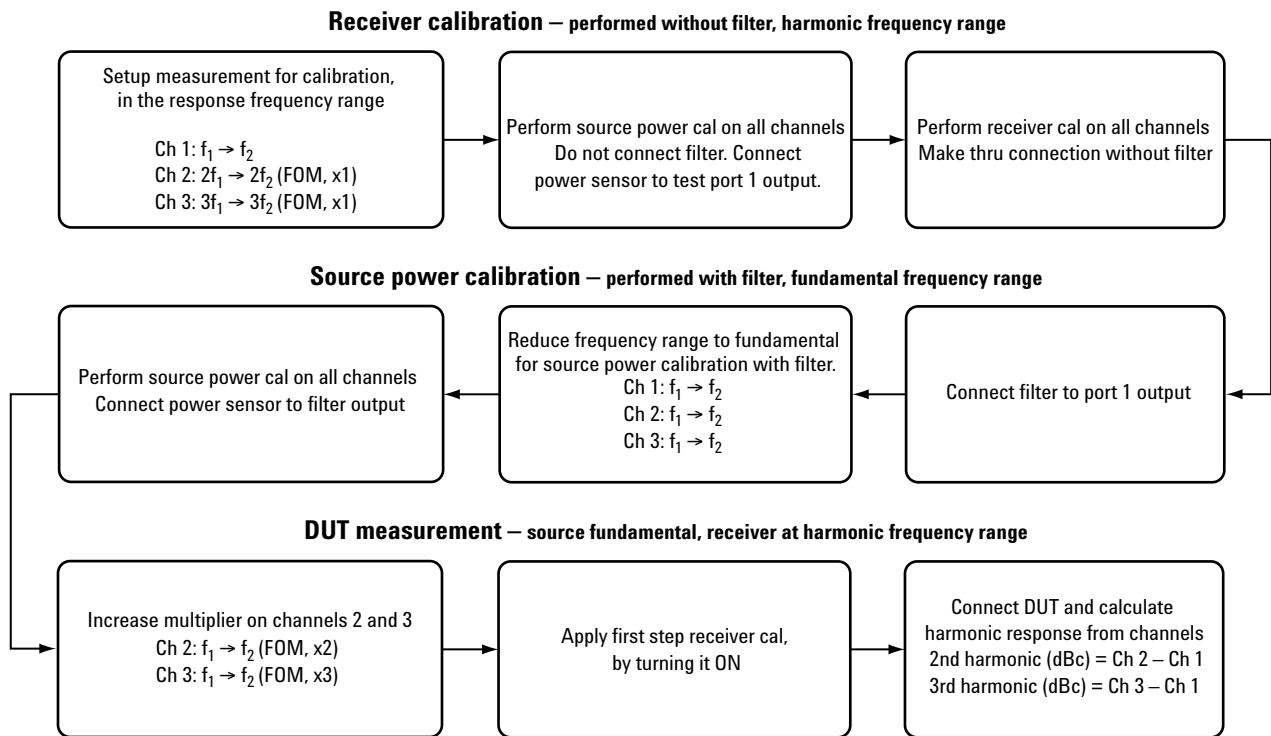

Figure 15. Procedure for measuring amplifier harmonics with source filtered.

Configure the frequency range of all three channels to the fundamental frequency range, which is where the source will be residing during harmonic testing.

Channel 1: **Start** > 1.4 [G/n] > **Stop** > 2.4 [G/n] – Remains unchanged

Channel 2: **Start** > 1.4 [G/n] > **Stop** > 2.4 [G/n]

Channel 3: **Start** > 1.4 [G/n] > **Stop** > 2.4 [G/n]

The receiver calibration will be turned off, as the frequency range is modified; though the receiver calibration will be preserved in the network analyzer's memory. The source calibration will be extrapolated, rather than being turned off. This is to protect your test device from being overpowered by the source. If the original settings are restored, then source-power calibration returns to full correction.

Source-power calibration

Perform a source-power calibration on channels 1, 2, and 3 by connecting a power sensor to the output of the filter. Although the status bar for channel 1 indicates an active "Src Pwr Cal", the source power cal in the instrument is not applicable to the current setup, since a filter was added to the test port output.

Select channel 1: menu item **Calibration > Power Calibration ... > Source Power Cal**

Select channel 2: menu item **Calibration > Power Calibration ... > Source Power Cal**

Select channel 3: menu item **Calibration > Power Calibration ... > Source Power Cal**

Once the calibration is done, note the "Src Pwr Cal" indicator on the status bar for all three channels.

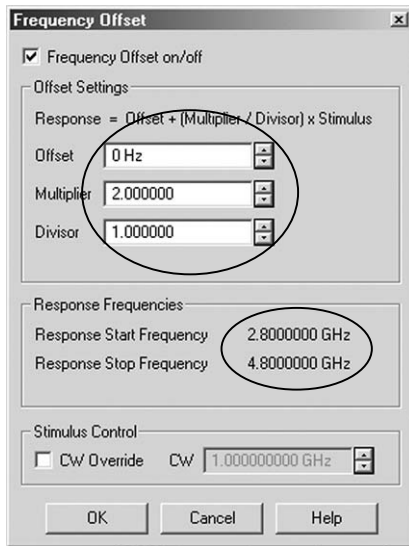

Step 3: Modify settings

Modify frequency-offset settings

Modify frequency-offset mode settings to measure the appropriate response.

Channel 1: Leave as is, to measure f_1 from 1.4 to 2.4 GHz.

Channel 2: Setup to measure second harmonic from 2.4 to 4.8 GHz. Use a multiplier of x2.

Channel 3: Setup to measure third harmonic from 4.2 to 7.2 GHz. Use a multiplier of x3.

Menu item **Channel > Frequency Offset ...**

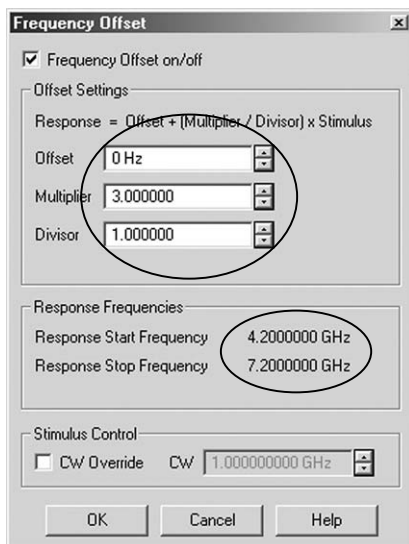

Next turn on receiver calibration on all three channels. This step applies the receiver calibration performed in Step 1 to this measurement.

Menu item **Calibration > Power Calibration ... > Receiver Cal On**

Now the source is calibrated after the filter, and the receiver is calibrated to display the correct power level.

Step 4: Measure

Connect DUT and calculate the harmonic response

Next connect the amplifier after the filter and make the measurement. If you set up markers on channels 1, 2, and 3, and examine the difference between the values, you get the dBc value of the harmonic. Make sure you set the markers to the appropriate stimulus. Channel 2 markers should be set to twice the frequency of channel 1 markers. Channel 3 markers should be set to three times the frequency of channel 1 markers.

Channel 1: [Marker] > Marker 1 > 2 [G/n]

Channel 2: [Marker] > Marker 1 > 4 [G/n]

Channel 3: [Marker] > Marker 1 > 6 [G/n]

Figure 16. Configure channel 2 frequency-offset mode for measuring the second harmonic and channel 3 frequency-offset mode for measuring the third harmonic.

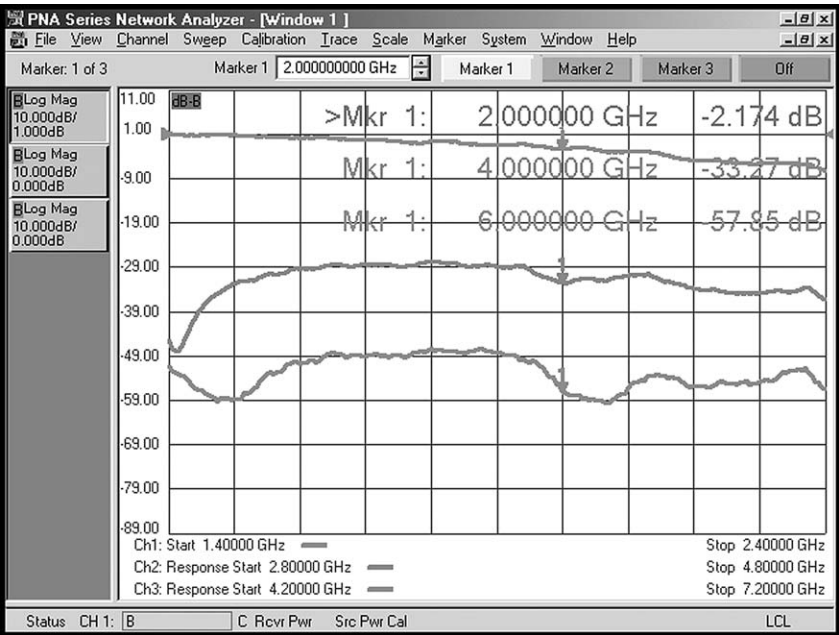

Figure 17. Measure the amplifier harmonics using the MW PNA Series with the source filtered.

In the example shown in Figure 17, the second harmonic is approximately 31 dB lower than the fundamental ($-33.27 - -2.174$). The third harmonic is approximately 56 dB lower than the fundamental ($-57.85 - -2.174$).

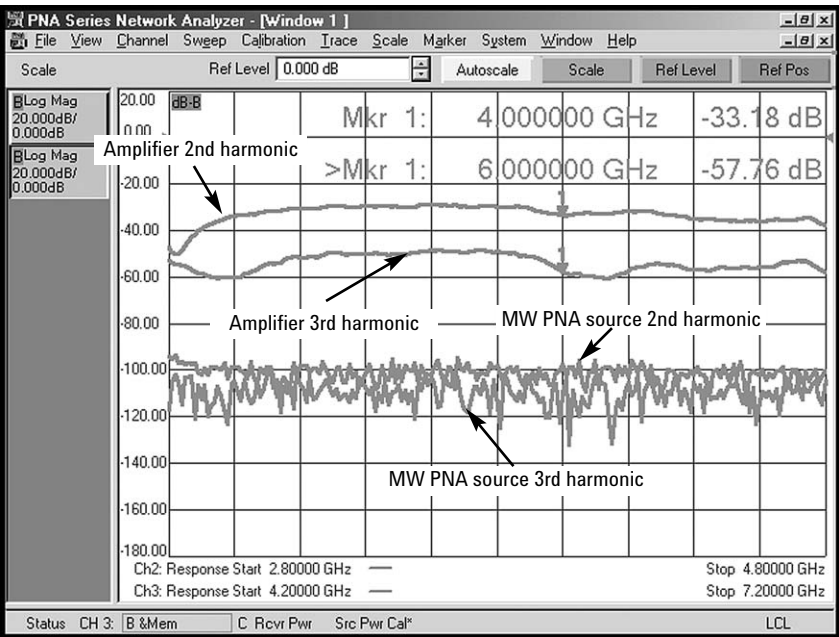

Figure 18. A comparison of the MW PNA source harmonics to the amplifier harmonics.

If you perform the above measurement without the amplifier, with a simple through connection, you will measure the harmonics of the network analyzer source. This will indicate the level of error due to the network analyzer's hardware. The four traces on Figure 18 show the MW PNA source 2nd and 3rd harmonic, and the amplifier's 2nd and 3rd harmonic. See Figure 11 for an image similar to Figure 18, with the exception that the source harmonics have not been filtered. Note the scale difference between the two figures.

Technique B. Source Harmonics Not Filtered, Scalar-Mixer Calibration

The Frequency Converter Application, Option 083, includes a scalar-mixer calibration (SMC). Even though we are testing an amplifier, SMC can be used for this measurement. In concept, SMC approximately combines a source power cal and receiver cal with match correction, thereby providing very accurate measurement results.

For testing amplifiers, it is important to note that **SMC does not actually level the power at the test port**, whereas a source-power calibration does level the power. In order to get the benefit of leveled power, you can combine a source-power cal and an SMC cal.

Step 1: Setup

See Figure 1 for the hardware setup.

Step 2: Calibrate

[Preset]

Menu item **Calibration > Calibration Wizard ... > Mixer Calibrations > SMC_2P Scalar Mixer Cal > Create an expanded frequency list > Edit Frequencies**

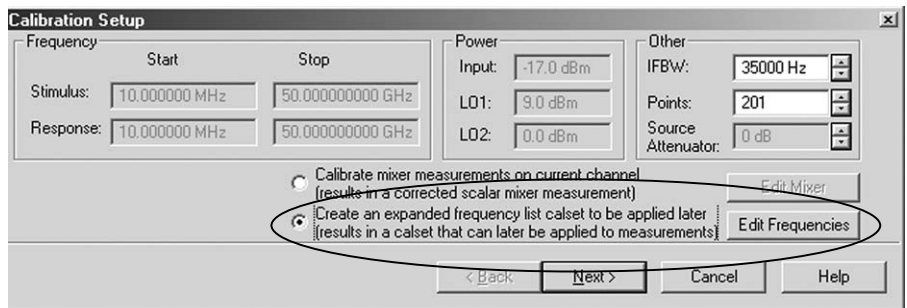

Figure 19. Perform a scalar-mixer calibration on a wide frequency range or frequency list.

Create a frequency list that covers the fundamental and harmonic frequencies. In this case, we are testing the fundamental, second and third harmonics. So the frequency list starts at f_1 or 1.4 GHz and stop as $3f_2$ or 7.2 GHz.

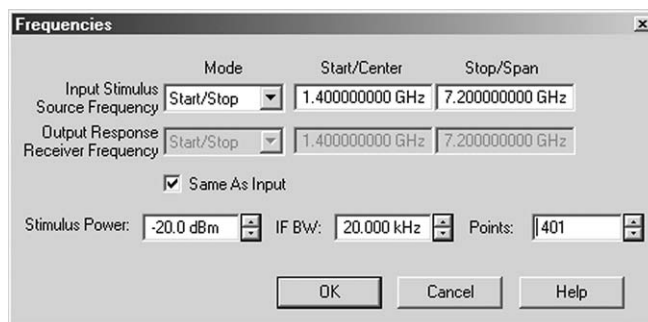

Figure 20. Configure the frequency range to cover the desired harmonics.

Select **ECal**. Then select the choice of **PNA Port 1**. This means that the PNA is calibrated with the source as port 1. ECal is used to reduce chances of error and save time.

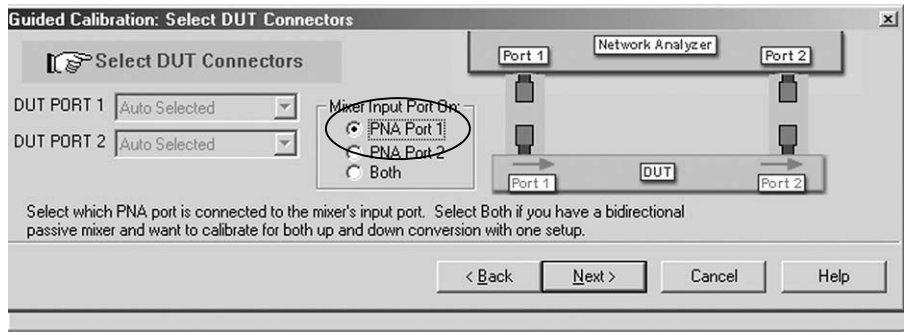
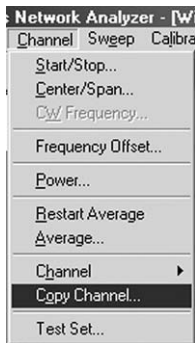

Figure 21. For harmonic measurements, a one-sided PNA Port 1 calibration is sufficient.

Follow the guided wizard, attach the ECal module, and perform a calibration. Next you will need to connect a power sensor to port 1 to perform a power-meter calibration, and to measure the input match of the power sensor for match correction. For 401 points, the power-meter calibration takes a few minutes. This calibration will be saved in memory and we will retrieve it later.

Next, perform a source-power calibration to obtain leveled power. Start with channel 1 and then copy channel 1 to channels 2 and 3, so the source power cal is applied to all channels.



[Preset]

[Start/Center] > Start 1.4 [G/n] > Stop 2.4 [G/n]

[Power] > Level -20 [Enter]

Menu item **Calibration > Power Calibration ... > Source Power Cal**

Connect the power sensor to port 1 and complete the source-power calibration.

Copy channel 1 to channels 2 and 3. Menu item **Channel > Copy Channel ...**

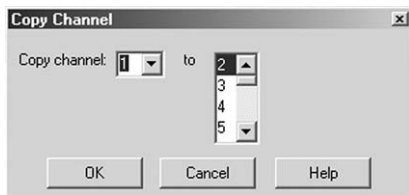

Delete the traces, so you can configure an SMC trace. The source-power calibration will be retained within the channel.

Select channel 1: menu item **Trace > Delete Trace**

Select channel 2: menu item **Trace > Delete Trace**

Select channel 3: menu item **Trace > Delete Trace**

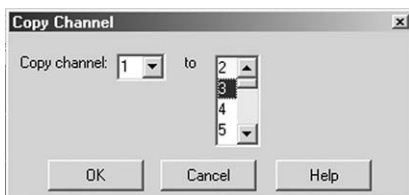

Configure channel 1 for an SMC trace to measure the fundamental, channel 2 to measure the 2nd harmonic, and channel 3 to measure the 3rd harmonic.

Menu item **Trace > New Trace... > Application... > Scalar Mixer/Converter Forward Direction in Channel 1.**

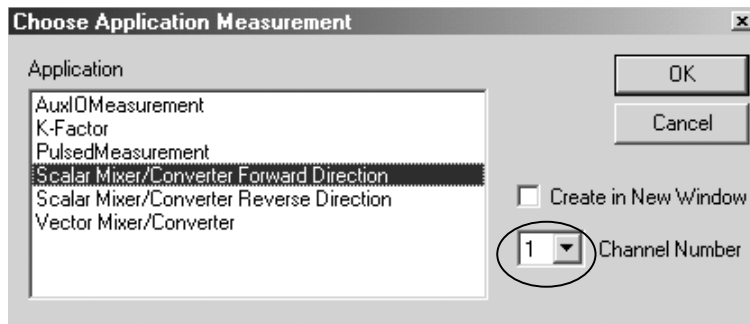

Figure 23. A scalar-mixer measurement can be used for harmonic measurements.

Figure 22. Copy channel 1 to channels 2 and 3, in order to copy the source-power calibration.

Set the frequency range to 1.4 to 7.2 GHz, with a multiplier of 1, so that the response is measuring 1.4 to 7.2 GHz.

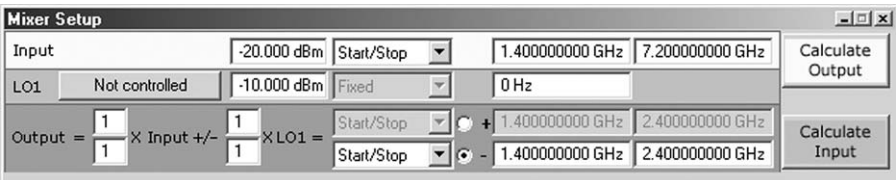

Figure 24. Set the frequency range to cover f_1 to $3f_2$.

Repeat this procedure for channels 2 and 3.

Menu item **Trace > New Trace. ... > Application > Scalar Mixer/Converter Forward Direction in Channel 2.**

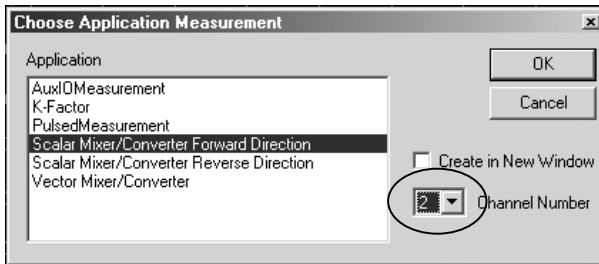

Figure 25. A scalar-mixer measurement can be used for harmonic measurements.

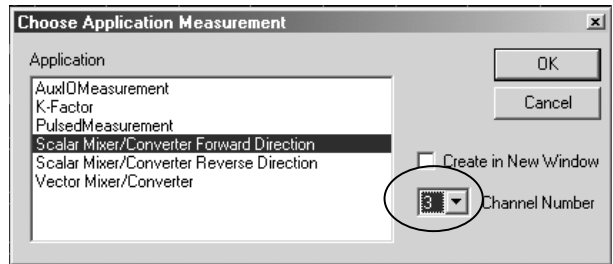

Figure 26. A scalar-mixer measurement can be used for harmonic measurements.

Menu item **Trace > New Trace. ... > Application > Scalar Mixer/Converter Forward Direction in Channel 3.**

Select channel 1 and recall the appropriate cal set. From menu item **Calibration**, select **Cal Set**.

Recall the scalar-mixer cal that you just performed.

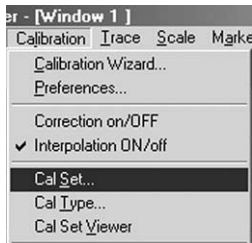

Figure 27. The appropriate cal set has to be applied for a valid measurement.

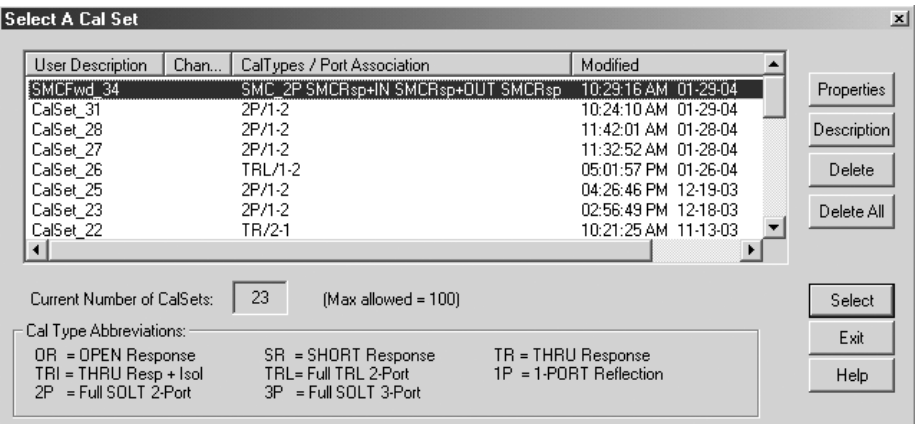

Figure 28. Choose the appropriate cal set. The "Modified" time stamp provides an easy way to find the appropriate cal.

Select custom calibration type "SMC_2P".

Apply the cal set to the channel. Perform the same steps on channels 2 and 3.

Channel 2: Menu item **Calibration > Cal Set > Select appropriate cal set**

Channel 3: Menu item **Calibration > Cal Set > Select appropriate cal set**

Afterwards, you can expect a display such as the one shown in Figure 29, for a through measurement, where all three channels show the same data. Then we will modify the stimulus settings on channels 1, 2, and 3 to make the harmonics measurement.

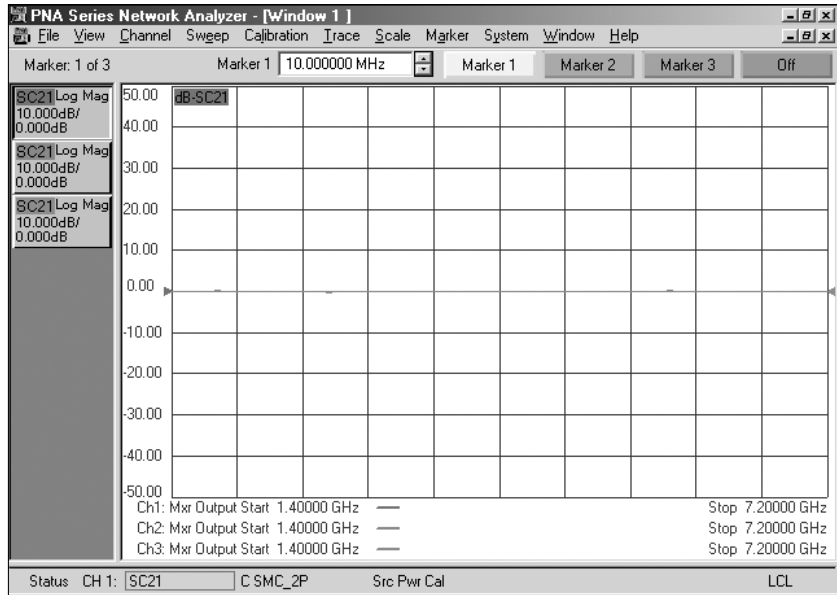

Figure 29. All three channels are calibrated.

Step 3: Modify settings

On channel 1, reduce the frequency range to 2.4 GHz. On channel 2, to 2.4 GHz with a multiplier of 2. On channel 3, reduce the frequency range to 2.4 GHz, with a multiplier of 3.

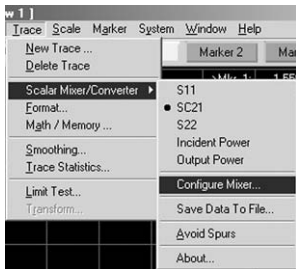

Figure 30. Trace > Scalar Mixer/Converter > Configure Mixer... allows control of the frequency range.

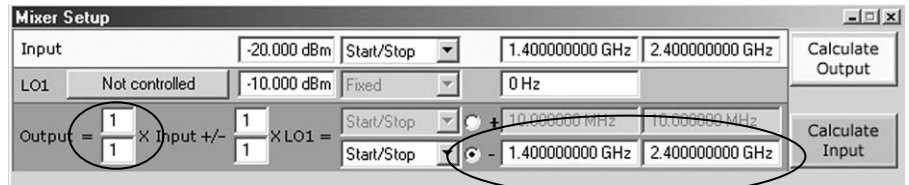

Figure 31. Channel 1 setting to measure fundamental frequency.

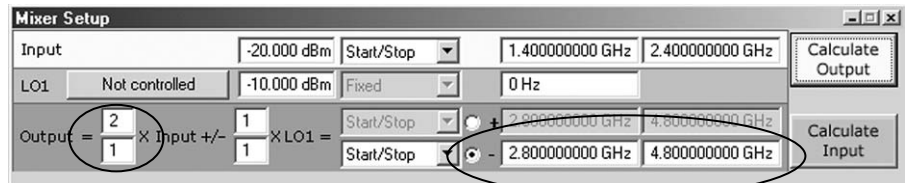

Figure 32. Channel 2 setting to measure second harmonic.

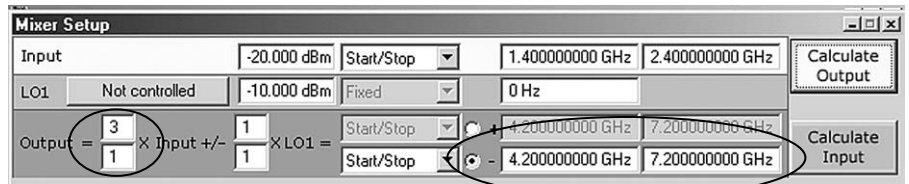

Figure 33. Channel 3 setting to measure third harmonic.

Step 4: Measure

Connect the amplifier between port 1 and port 2 and measure the harmonic distortion. If you set up markers on channels 1, 2, and 3, and examine the difference between the values, you get the dBc value of the harmonic. Make sure you set the markers to the appropriate stimulus. Channel 2 markers should be set to twice the frequency of channel 1 markers. Channel 3 markers should be set to three times the frequency of channel 1 markers.

Channel 1: [Marker] > Marker 1 > 2 [G/n]

Channel 2: [Marker] > Marker 1 > 4 [G/n]

Channel 3: [Marker] > Marker 1 > 6 [G/n]

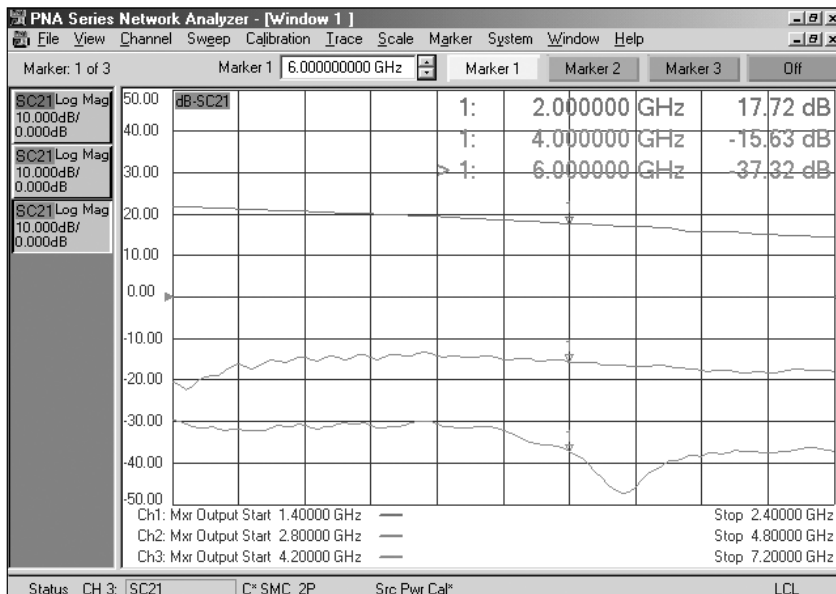

Figure 34. Use the MW PNA Series to measure the fundamental, 2nd and 3rd harmonic of amplifiers.

In this example, the second harmonic is approximately 28 dB lower than the fundamental (17.86 – -10.37). The third harmonic is approximately 59 dB lower than the fundamental (17.86 – -36.35).

References

Microwave PNA Series Network Analyzer Application Note 1408-7, *Amplifier Linear and Gain Compression Measurements*, Literature number 5988-8644EN

Microwave PNA Series Network Analyzer Application Note 1408-9, *Amplifier Intermodulation Distortion Measurements*, Literature number 5988-9474EN

Web Resources

For additional literature and product information about the Agilent PNA Series visit: www.agilent.com/find/pna

For additional information about Agilent electronic calibration (ECal) modules visit: www.agilent.com/find/ecal

Windows® is a U.S. registered trademark of the Microsoft Corporation.



Agilent Email Updates

www.agilent.com/find/emailupdates

Get the latest information on the products and applications you select.

www.agilent.com

Agilent Technologies' Test and Measurement Support, Services, and Assistance

Agilent Technologies aims to maximize the value you receive, while minimizing your risk and problems. We strive to ensure that you get the test and measurement capabilities you paid for and obtain the support you need. Our extensive support resources and services can help you choose the right Agilent products for your applications and apply them successfully. Every instrument and system we sell has a global warranty. Two concepts underlie Agilent's overall support policy: "Our Promise" and "Your Advantage."

Our Promise

Our Promise means your Agilent test and measurement equipment will meet its advertised performance and functionality. When you are choosing new equipment, we will help you with product information, including realistic performance specifications and practical recommendations from experienced test engineers. When you receive your new Agilent equipment, we can help verify that it works properly and help with initial product operation.

Your Advantage

Your Advantage means that Agilent offers a wide range of additional expert test and measurement services, which you can purchase according to your unique technical and business needs. Solve problems efficiently and gain a competitive edge by contracting with us for calibration, extra-cost upgrades, out-of-warranty repairs, and onsite education and training, as well as design, system integration, project management, and other professional engineering services. Experienced Agilent engineers and technicians worldwide can help you maximize your productivity, optimize the return on investment of your Agilent instruments and systems, and obtain dependable measurement accuracy for the life of those products.

For more information on Agilent Technologies' products, applications or services, please contact your local Agilent office.

Phone or Fax

United States:

(tel) 800 829 4444
(fax) 800 829 4433

Canada:

(tel) 877 894 4414
(fax) 800 746 4866

China:

(tel) 800 810 0189
(fax) 800 820 2816

Europe:

(tel) 31 20 547 2111

Japan:

(tel) (81) 426 56 7832
(fax) (81) 426 56 7840

Korea:

(tel) (080) 769 0800
(fax) (080) 769 0900

Latin America:

(tel) (305) 269 7500

Taiwan:

(tel) 0800 047 866
(fax) 0800 286 331

Other Asia Pacific Countries:

(tel) (65) 6375 8100
(fax) (65) 6755 0042
Email: tm_ap@agilent.com

Contacts revised: 09/26/05

The complete list is available at: www.agilent.com/find/contactus

Product specifications and descriptions in this document subject to change without notice.

© Agilent Technologies, Inc. 2003, 2004, 2006
Printed in USA, August 14, 2006
5988-9473EN



Agilent Technologies