

Agilent PNA Microwave Network Analyzers

Application Note 1408-11

Accurate Pulsed Measurements

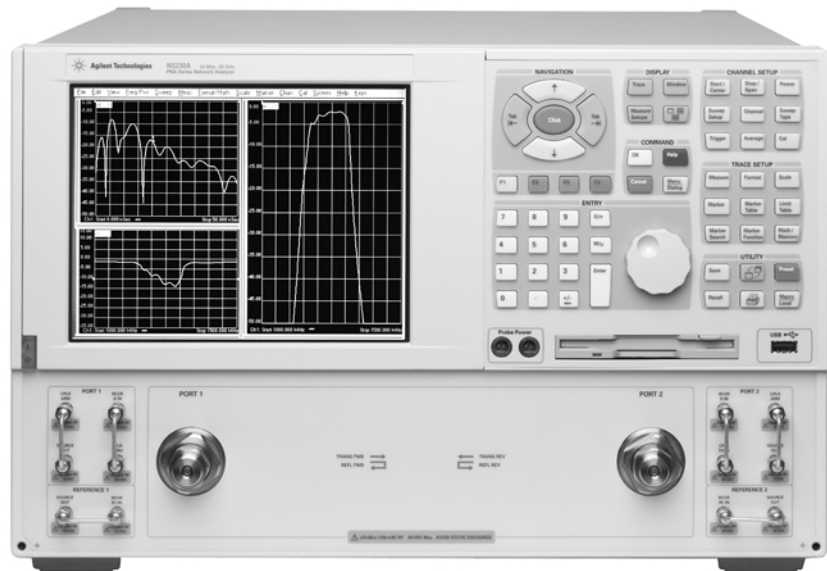

Agilent Technologies

High Performance Pulsed S-parameter Measurements

Vector network analyzers are traditionally used to measure the continuous wave (CW) S-parameter performance of components. Often under these operating conditions the analyzer is functioning as a narrowband measurement instrument. It transmits a known CW frequency to the component and measures the CW frequency response. If we were to look at the response of a single CW frequency we would see a single spectral tone in the frequency domain. The analyzer has a built in source and receivers that are designed to operate together in a synchronous manner, utilizing narrowband detection, to measure the frequency response of the component. Most analyzers can be configured to generate a frequency sweep over many frequency tones.

In some cases the signal applied to the component must be pulsed (turned on and off) at a specific rate and duration. If we were to look at the frequency domain response of a single pulsed tone, it would contain an infinite number of spectral tones making it challenging to utilize a standard narrowband VNA. This article describes how to configure and make accurate pulsed S-parameter measurements using the Agilent microwave PNA network analyzer.

Pulsed Signals

To see what the frequency domain spectrum of a pulsed signal looks like we first mathematically analyze the time domain response. Equation 1 illustrates the time domain relationship of a pulsed signal. This is generated by first creating a rectangular windowed version ($\text{rect}(t)$) of the signal with pulse width PW. A Shah function is then realized consisting of a periodic train of impulses spaced $1/\text{PRF}$ apart where PRF is the pulse repetition frequency. This can also be viewed as impulses at spacing equal to the pulse period. The windowed version of the signal is then convolved with the shah function to generate a periodic pulse train in time corresponding to the pulsed signal.

$$y(t) = (\text{rect}_{pw}(t) \cdot x(t)) * \text{shah} \frac{1}{prf}(t)$$

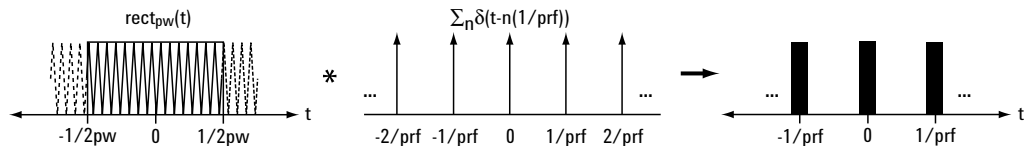

Equation 1 – Time domain view of pulsed signal

To look at this signal in the frequency domain we perform a Fourier transform on the pulsed signal $y(t)$.

$$Y(s) = (pw \cdot \text{sinc}(pw \cdot s) * X(s)) \cdot (prf \cdot \text{shah}(prf \cdot s))$$

$$Y(s) = (pw \cdot \text{sinc}(pw \cdot s)) \cdot (prf \cdot \text{shah}(prf \cdot s))$$

$$Y(s) = \text{DutyCycle} \cdot \text{sinc}(pw \cdot s) \cdot \text{shah}(prf \cdot s)$$

Equation 2 – Fourier transform of time domain pulsed signal

Equation 2 shows that the frequency domain spectrum of the pulsed signal is a sampled sinc function with sample points (signal present) equal to the pulse repetition frequency.

Figure 1 shows what the pulsed spectrum would look like for a signal that has a pulse repetition frequency of 1.69 kHz and a pulse width of 7 μ s. Figure 2 is the same pulsed spectrum zoomed in on the fundamental frequency that is pulsed (center of plot). Notice that the spectrum has components that are $n \cdot \text{PRF}$ away from the fundamental. The fundamental tone contains the measurement information. The PRF tones are artifacts of pulsing the fundamental tone. It is also worthy to note that the magnitudes of the spectral components close to the fundamental tone are relatively large.

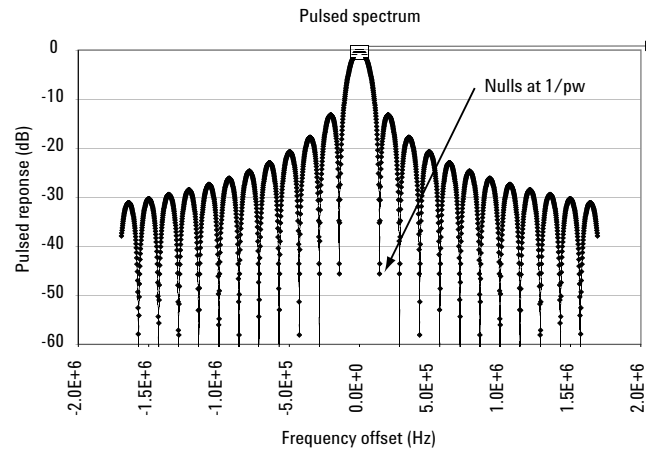

Figure 1 – Frequency domain of pulsed signal

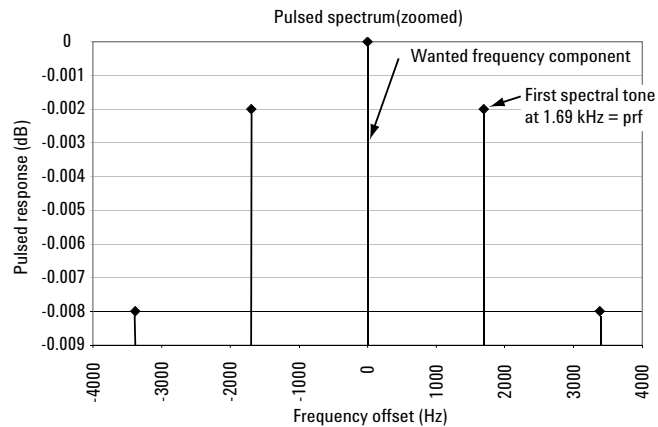

Figure 2 – Zoomed frequency domain of pulsed signal

Microwave PNA Pulsed Measurement Techniques

The Agilent microwave PNA is a high-performance network analyzer that utilizes narrow-band detection of microwave energy. It downconverts the received signal to an intermediate frequency (IF) that is then digitized (sampled at discrete intervals) and digitally filtered for display and analysis. There are two different methods for measuring the S-parameters of a pulsed signal using the microwave PNA: 'Synchronic Pulse Acquisition' and 'Spectral Nulling'. Synchronic pulse acquisition is analogous to the 'Full Pulse Characterization' mode of operation on the Agilent 8510 network analyzer. Spectral nulling is analogous to the 'High PRF' mode of operation in the 8510 series except that point-in-pulse and pulse-profiling can be performed whereas they could not on the 8510 in 'High PRF' mode.

Synchronic pulse acquisition

This method provides synchronic timing between the individual incoming pulses and the analyzers discrete sampling. If the pulse width exceeds the minimum time to synchronize and acquire one or more discrete data points then the measurement falls into the synchronic pulse acquisition mode of operation (see Figure 3) and the receiver performs at its full CW sensitivity and dynamic range with no pulse desensitization. Pulse-to-pulse characterization can be measured in this mode with each displayed data point corresponding to one individual pulse. This measurement is configured by aligning the incoming pulses with the sampling intervals of the analyzer using trigger-on-point mode and applying an external trigger to measure each pulse. The analyzer must see 100 μs of pulsed signal before the acquisition period. This accounts for PNA hardware filter settling. There is a 70 μs delay between the applied trigger and when the analyzer begins digitization of one discrete point. Therefore a 30 μs delay should be applied between the incoming pulse and applied trigger to account for the 100 μs of pre-acquisition pulsed RF. The minimum acquisition time on the analyzer is roughly proportional to 1/IF bandwidth. As the IF bandwidth is decreased the measurement acquisition time for each data point increases. The minimum acquisition time on the analyzer is 30 μs for an IF bandwidth setting of 35 kHz. This corresponds to a minimum measurable pulse width of 130 μs .

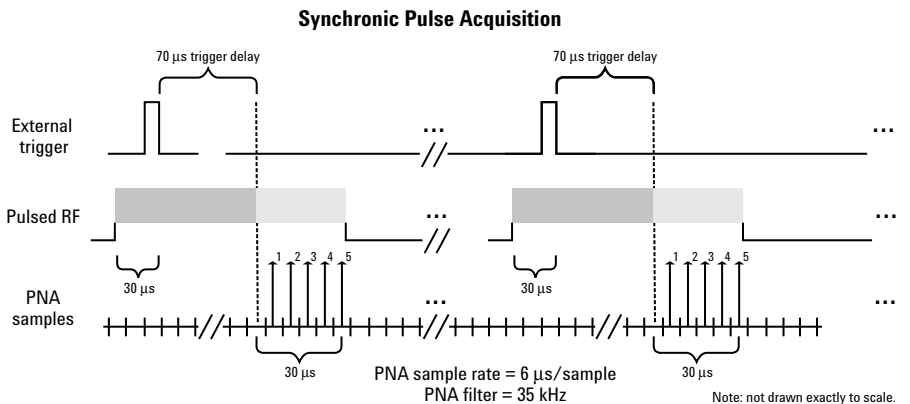

The number of samples required to display one data point with a 35 kHz filter is 5.

The analyzer must see 100 μs of pulsed signal before acquisition. This corresponds to a 30 μs delay between the pulse and the trigger signal as illustrated above. This ensures that the receivers are configured properly for the acquisition of the pulse.

For pulse widths greater than $\sim 130 \mu\text{s}$ the PNA can be triggered to synchronously measure one pulse per displayed data point.

Figure 3 – Time domain representation of Synchronic Pulse Acquisition mode

Hardware configuration

The Synchronic mode of operation requires a pulse generator to supply the timing width and delays for the external triggering and the modulation. Modulation can be supplied by modulating the DUT bias or modulating the source signal. Figure 4 shows the hardware configuration for a pulsed bias measurement. The standard microwave PNA has both a trigger-in and trigger-out (ready for trigger) BNC connector that may be used to synchronize the trigger timing of the analyzer and pulse generator. In point mode, applying a trigger-in signal will cause the analyzer to acquire data for the first frequency point, move the source frequency to the next point, and then send a trigger-out signal to notify the pulse generator that it is ready to acquire the next data point. At this point the pulse generator may send a trigger to the analyzer to acquire the next data point.

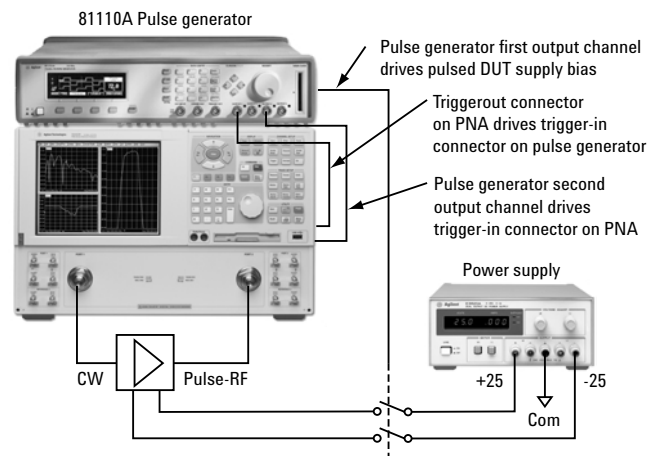

Figure 4 – Hardware for pulse biasing DUT

Spectral nulling

Spectral nulling is usually used when the pulse width is less than the minimum time required to digitize and acquire one discrete data point. Therefore multiple pulses must be captured for one data point acquisition. There is no strict synchronization between the individual incoming pulses and the time domain sampling of the analyzer. The frequency domain representation of the pulsed signal has discrete PRF tones that can be filtered out, leaving the fundamental tone which carries the measurement information. During the downconversion process in the analyzer, filtering is applied to reject unwanted noise and signal components. Once the signal is digitized, the analyzer applies a digital filter with an IF bandwidth specified by the user. Typically this filter is used to reduce measurement noise and increase dynamic range. The digital filtering algorithm works well for non-pulsed signals, but what occurs when the receiver receives a pulsed signal? Using a narrowband detector, we ideally want a digital rectangular filter to filter out everything but the fundamental pulsed frequency component. This would require a filter that would have a minimum stopband frequency less than the PRF of the pulsed signal with optimum rejection. The filter transition slope should be well away from the first PRF tone (as illustrated in Figure 5), so that there is maximum rejection of the unwanted tones. This filter may be difficult to design because the PRF tones may be in close proximity to the fundamental tone. Strict rectangular filters in the frequency domain have some tradeoffs such as excessive ringing in the time domain. As such, filter designers adopt differing techniques to get the best performance in both frequency and time domain while still offering significant filtering performance.

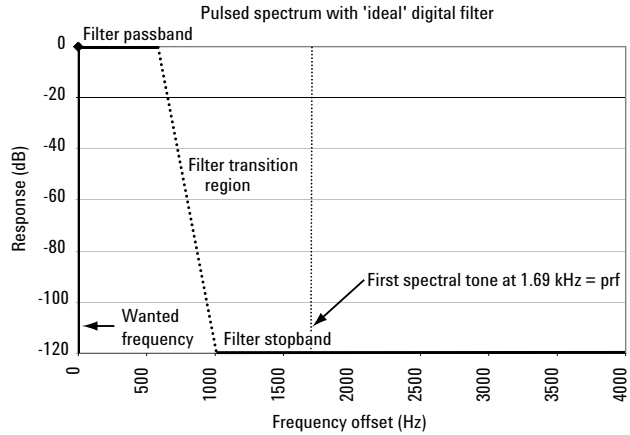

Figure 5 – Frequency domain of 'ideal' digital filter

Figure 6 shows the response of one possible digital IF filter used in the analyzer. It is not rectangular in shape and therefore, if used unaltered, would possibly pass unwanted components in the frequency domain, causing measurement error. Also notice that the digital filter has nulls which are periodically spaced in the frequency domain. The period of these nulls is proportional to the sample rate of the receiver and the architecture of the digital filter. Using the microwave PNA we are able to filter out the unwanted signal components by aligning the nulls of the digital filter with the unwanted pulsed spectrum components leaving the fundamental tone as illustrated in Figure 7. One advantage of this filtering technique is that the nulls of the filter are very deep and provide substantial rejection of the pulsed spectral components. Another advantage is that the nulls can be placed in close proximity to the fundamental tone because the transition regions at the nulls are very abrupt.

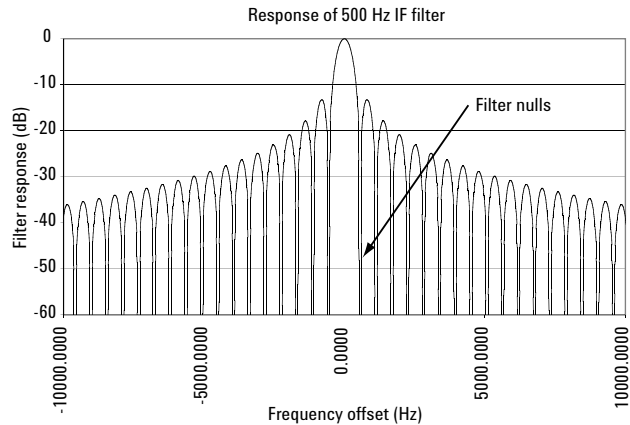

Figure 6 – Frequency domain of PNA digital filter

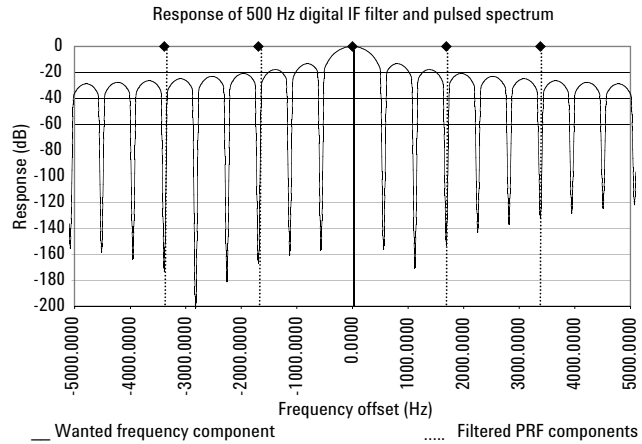
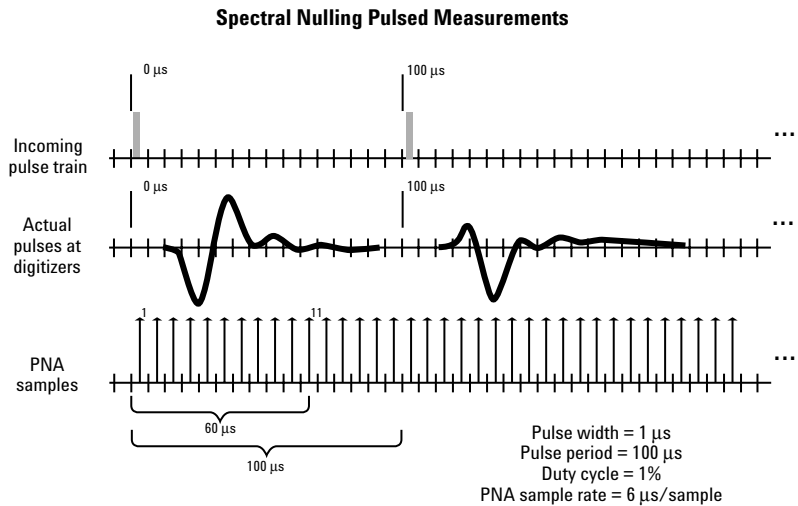

Figure 7 – Spectral Nulling of pulsed harmonics

It is interesting to view what is occurring in the time domain. Figure 8 provides a representative view of the pulsed signal and the analyzer discrete samples. The pulse that is digitized by the samplers has lost its original time domain shape due to downconversion and various hardware filtering components applied to the pulse while traveling through the narrowband receiver. Also notice that the pulse-to-pulse shape seen at the digitizers has changed due to the difference in the phase relationship between the PRF and the swept frequency. The number of pulses sampled during one data point acquisition is dependent on the IF bandwidth setting, pulse period and pulse width. In this example we are measuring a pulsed signal with a pulse period of 100 μ s and a pulse width of 1 μ s. The 500 Hz IF filter chosen for this measurement requires 292 samples, each spaced 6 μ s apart, to display one data point on the analyzer display. This means that during the acquisition time for one data point the analyzer has been sent 17 pulses with each digitized sample containing data from a different part of the incoming pulses.



The number of samples required to display one data point with a 500 Hz filter is 292.

*Number of pulses sent = $(292 \text{ pts} * 6 \mu\text{s}/\text{pt}) / (\text{pulse period}) = 17.52 \text{ pulses}$.
Round this to 17 because the 18th pulse has not been sent yet.*

Figure 8 – Time domain representation of Spectral Nulling mode

When using the spectral nulling mode of operation, there is a loss in dynamic range corresponding to the duty cycle, equal to $20 \cdot \log(\text{Duty Cycle})$. This is due to the narrowband filter rejecting everything except the fundamental tone of the pulsed signal. As the duty cycle decreases, more energy moves into the sidebands and less energy remains in the fundamental tone. This can be illustrated by analyzing equation 2 and noticing that the magnitude of the tones in the frequency domain decrease proportionally to the pulse width and the pulse repetition frequency (i.e. $\text{Duty Cycle} = (\text{PW} \cdot \text{PRF})$). For some analyzers this may limit measurement usability. One key benefit of using the microwave PNA in this configuration is that very narrow pulse widths (i.e. much less than $1 \mu\text{s}$) can be used as long as the duty cycle is large enough to provide acceptable measurement dynamic range. As the duty cycle decreases, the dynamic range reaches a point where the measurement results may not have sufficient accuracy. The microwave PNA excels using narrowband detection because of its outstanding performance in trace noise and dynamic range over other network analyzers (see Figure 9) as well as the utilization of spectral nulling.

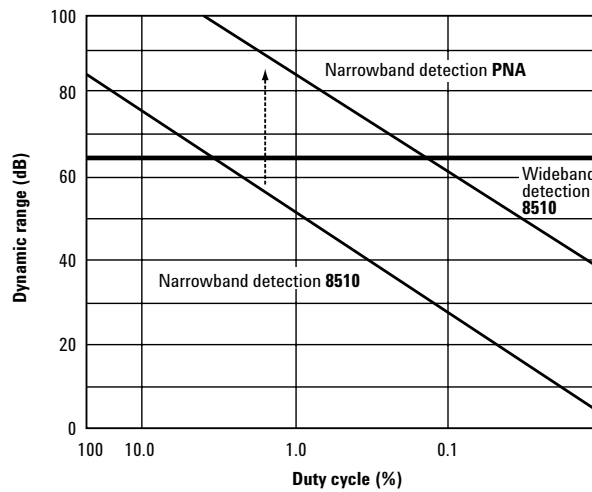

Figure 9 – Duty Cycle loss using Spectral Nulling mode

Hardware configuration

Measuring a component using the spectral nulling technique requires modulation supplied by modulating the DUT bias or by a pulsed stimulus. Figure 10 shows the hardware configuration for a pulsed stimulus measurement. Gate switches (modulators) are placed in front of the source and receivers where the delay and width of each of these gates can be set up independently. This pulses the analyzers internal source and provides time gating for the receivers to do point-in-pulse and pulse profiling as the following section illustrates. The external modulators and pulse generators largely define pulse width limitations. The pulse generator must have a phase-lock loop (PLL) reference (10 MHz) input to lock the analyzer and pulse generator to the same time base. This is essential to make sure the frequency domain components of the filter and pulsed spectrum are locked together during alignment of nulls with PRF components. The microwave PNA should be configured with options H08 and H11. Option H11 provides the IF gating hardware for point-in-pulse and pulse-profiling. Option H08 provides application software to configure the analyzer in spectral nulling mode.

In this particular configuration an external coupler is used to couple back the pulsed source signal to the reference receiver. This is beneficial when measuring ratioed parameters because any deviations in the external components after calibration will have minimal affect on the measurement results. Both the measurement and reference receiver will see the same deviations. A modulator is placed after the source and must have a frequency response equal to the DUT requirements (i.e. it must be able to pass the signal from the source with minimum attenuation). An amplifier may be placed after the modulator to provide a constant source match during measurement and calibration, and may also be used to increase the pulsed signal power. An isolator may be required (before the modulator) to isolate the analyzer source from the modulator, so that when the modulator is in the off state (no energy passing through modulator) that any high reflections, due to the off state match of the modulator, are minimized before reaching the analyzer. A high-pass filter may also be required (after the modulator) to filter out any video-feedthrough¹, generated by the modulator, which may interfere with the operation of the analyzer.

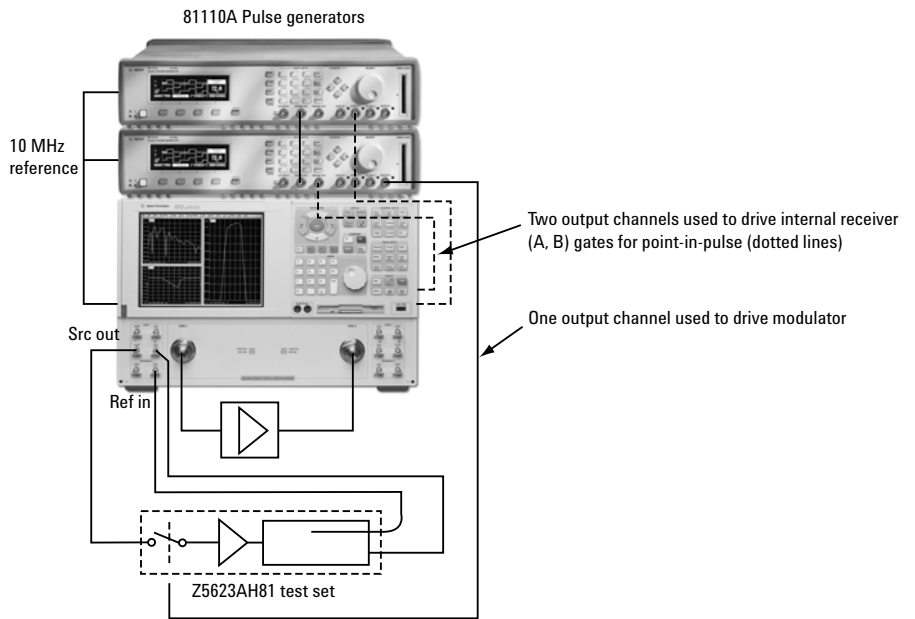

Figure 10 – Hardware for pulsed stimulus

Pulsed Response Measurement Types

There are three different pulse response measurement types that may be used to determine pulse characteristics. Any of these can be used with either the synchronic pulse acquisition or the spectral nulling techniques by utilizing receiver gating in the microwave PNA. Receiver gating is implemented by adding IF gates (switches) after the first converter (see Figure 11). These gates are TTL controlled and provide the hardware ability to perform point-in-pulse and pulse-profiling by providing a delay and width for the incoming pulsed RF signal.

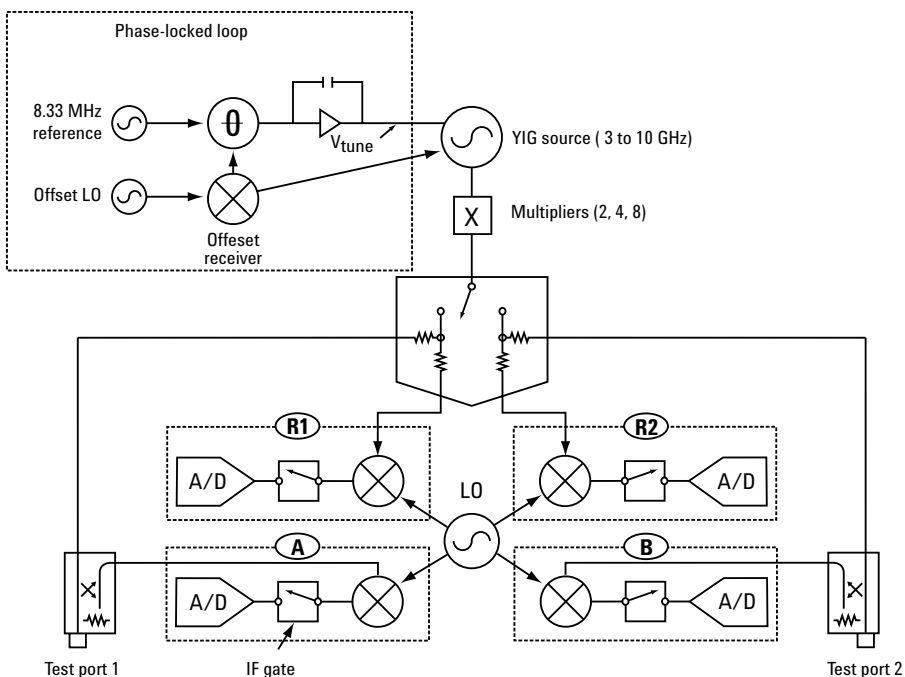

Figure 11 – PNA IF gating for point-in-pulse/pulse-profiling

- **Average-pulse** measurements are performed by not applying any receive triggering delay or gating. This means that the receiver measures and integrates all the energy from the DUT during the pulse duration. In effect, the gate width is set equal to or greater than the pulse width.
- **Point-in-pulse** measurements provide the user the ability to measure the output of the DUT at any point in time during the pulse by applying a time delay between when the source/bias is pulsed and when the receivers start taking data. A time gate width for which the pulsed energy is allowed to pass to the receivers can also be specified providing a variable receiver integration window.
- **Pulse-profiling** is similar to point-in-pulse except that the measurement information is displayed in time domain, at a CW frequency, where the time axis represents a point-in-pulse measurement with a variable time delay (i.e. from a starting delay to a stop delay). This can be thought of as walking the point-in-pulse measurement across the envelope of the pulse. With the microwave PNA the minimum receiver gate width is approximately 100 ns resulting in excellent resolution for pulse-profiling analysis.

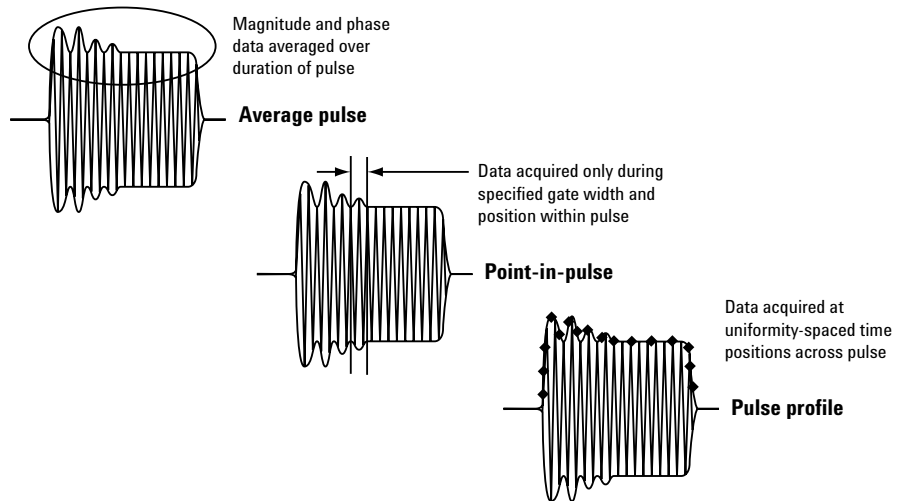

Figure 12 – Pulse response measurement types

Measurement example

Figure 13 shows an S-parameter filter measurement comparison between a signal with no pulsing (memory trace) and a signal with a 300 ns pulse width (data trace) both at similar IF bandwidth settings. For a 300 ns pulse width, the spectral nulling mode is utilized. With 1.35% duty cycle, we have effectively reduced our specified dynamic range by 37.4 dB ($20 \cdot \log(\text{Duty Cycle})$). This can be visualized by comparing the rejection of the memory trace with that of the data trace at the marker. The data trace is showing a stop band rejection figure of approximately 80 dB. The memory trace is showing rejection of approximately 115 dB which is a 35 dB difference corresponding to the 37.4 dB duty cycle loss. If required one can gain back 10 dB ($10 \cdot \log(\# \text{ of averages})$) by applying 10 averages to the measurement (see Figure 14).

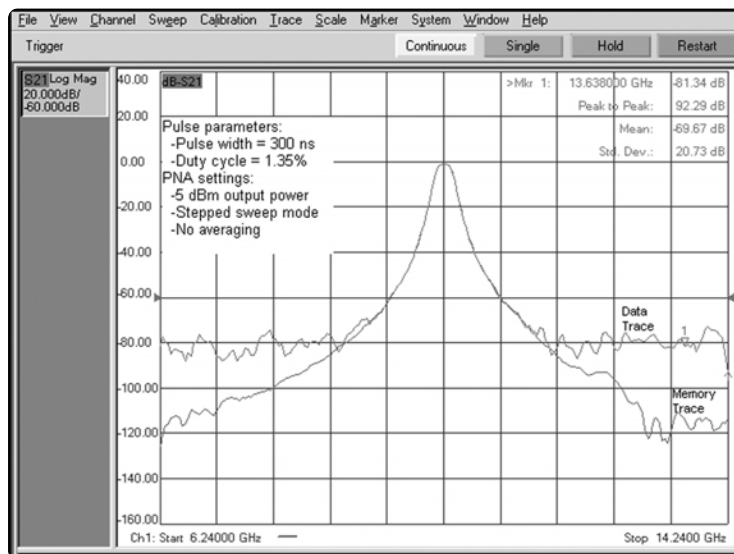

Figure 13 – Spectral Nulling mode with 300 ns PW, 1.35% duty cycle, no averaging

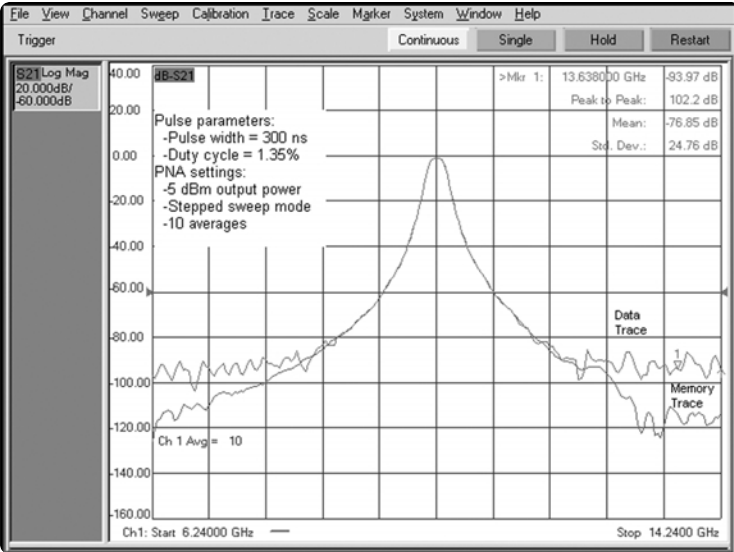

Figure 14 – Spectral Nulling mode with 300 ns PW, 1.35% duty cycle, 10 averages

With a 300 ns pulse width and 1.35% duty cycle the PRF is 45 kHz. This means that the first PRF tone is 45 kHz away from the fundamental. Figure 15 illustrates a similar measurement using the same 1.35% duty cycle, but with a pulse width of 5 us. In this case the PRF is 2.7 kHz which places a PRF tone much closer to the fundamental tone. Narrowband detection techniques may have difficulties filtering out a tone this close to the fundamental. However, the spectral nulling technique has no difficulties nulling this tone. We would expect that the duty cycle loss would be the same for the 300 ns and 5 us pulse width examples because the duty cycles are the same. Figures 13 and 15 illustrate this by noticing that the rejection regions for both examples are the same at approximately 80 dB.

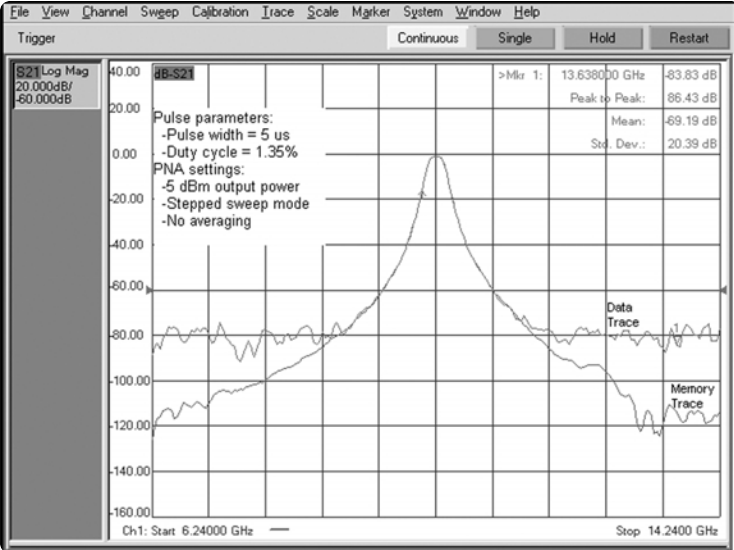

Figure 15 – Spectral Nulling mode with 5 us PW, 1.35% duty cycle, no averaging

Conclusion

The results show that accurate pulsed measurements can be made with the Agilent microwave PNA. Both the Synchronic Pulse Acquisition and Spectral Nulling modes offer flexible alternatives for measuring the pulsed S-parameters of components. Very narrow pulse widths ($<1 \mu\text{s}$) can be used as long as the duty cycle is large enough for acceptable measurement dynamic range. The exceptional hardware performance of the microwave PNA, and the use of the spectral nulling mode, largely offset the limitations of using a narrowband detection technique for pulsed measurements. The Agilent E8362/3/4B and E8361A microwave series of PNA network analyzers should be configured with Option H08 and H11 if using the spectral nulling technique and/or if point-in-pulse/pulse-profiling is required.

Contact Agilent Technologies for more information on pulsed configurations.

References

Agilent Technologies, *Pulsed Measurements using the Microwave PNA Series Network Analyzer*, Agilent Technologies White Paper, publication number 5988-9480EN

Agilent Technologies, *Triggering the PNA Series Network Analyzer for Antenna Measurements*, Agilent Technologies White Paper, publication number 5988-9518EN

Agilent Technologies, *Pulsed Measurements with the Agilent 8720ES and 8753ES Network Analyzers*, Agilent Technologies Product Note, May 2000, publication number

Agilent Technologies, *Using a Network Analyzer to Characterize High-Power Components*, Agilent Technologies Application Note AN 1287-6, Mar 2003

J. Barr, R. Grimmet, and R. McAleenan, *Pulsed-RF Measurements and the HP 8510B Network Analyzer*, HP RF & Microwave Measurement Symposium and Exhibition, Aug 1988

Hewlett Packard, *85108A Pulsed Network Analyzer System*, Hewlett Packard System Manual, March 1995

Hewlett Packard, *HP 8510B Pulsed-RF Network Analyzer*, HP Users Guide, March 1995

J. Scott, M. Sayed, P. Schmitz, and A. Parker, *Pulsed-bias / Pulsed-RF Device Measurement System Requirements*, 24th European Microwave Conference, pp. 951-961, Cannes France, September 5-8, 1994.

J. Swanstrom, R. Shoulders, *Pulsed Antenna Measurements with the 8530A Microwave Receiver*, Hewlett Packard, AMTA conference, undated

P. Schmitz, M. Sayed, *Techniques for Measuring RF and MW Devices in a Pulsed Environment*, Hewlett Packard, Feb 1993

B. Taylor, M. Sayed, K. Kerwin, *A Pulse Bias / RF Environment for Device Characterization*, 42nd IEEE ARFTG, San Jose, CA, Dec 1993

Hewlett Packard, *Pulsed-RF Network Analysis using the 8510B*, HP Product Note 8510-9, Jan 1988

Hewlett Packard, *Spectrum Analysis - Pulsed-RF*, HP Application Note 150-2

D. C. Nichols, *Capture and Analysis of Individual Radar Pulses Using a High-Speed, High-Resolution Digitizer*, HP RF & Microwave Measurement Symposium, Sept 1987

Web resources

PNA Series: www.agilent.com/find/pna

ECal electronic calibration: www.agilent.com/find/ecal



Agilent Email Updates

www.agilent.com/find/emailupdates

Get the latest information on the products and applications you select.

Agilent Technologies' Test and Measurement Support, Services, and Assistance

Agilent Technologies aims to maximize the value you receive, while minimizing your risk and problems. We strive to ensure that you get the test and measurement capabilities you paid for and obtain the support you need. Our extensive support resources and services can help you choose the right Agilent products for your applications and apply them successfully. Every instrument and system we sell has a global warranty. Support is available for at least five years beyond the production life of the product. Two concepts underlie Agilent's overall support policy: "Our Promise" and "Your Advantage."

Our Promise

Our Promise means your Agilent test and measurement equipment will meet its advertised performance and functionality. When you are choosing new equipment, we will help you with product information, including realistic performance specifications and practical recommendations from experienced test engineers. When you use Agilent equipment, we can verify that it works properly, help with product operation, and provide basic measurement assistance for the use of specified capabilities, at no extra cost upon request. Many self-help tools are available.

Your Advantage

Your Advantage means that Agilent offers a wide range of additional expert test and measurement services, which you can purchase according to your unique technical and business needs. Solve problems efficiently and gain a competitive edge by contracting with us for calibration, extra-cost upgrades, out-of-warranty repairs, and onsite education and training, as well as design, system integration, project management, and other professional engineering services. Experienced Agilent engineers and technicians worldwide can help you maximize your productivity, optimize the return on investment of your Agilent instruments and systems, and obtain dependable measurement accuracy for the life of those products.

Agilent T&M Software and Connectivity

Agilent's Test and Measurement software and connectivity products, solutions and developer network allows you to take time out of connecting your instruments to your computer with tools based on PC standards, so you can focus on your tasks, not on your connections. Visit www.agilent.com/find/connectivity for more information.

By internet, phone, or fax, get assistance with all your test & measurement needs

Phone or Fax	Korea:
United States:	(tel) (82 2) 2004 5004
(tel) 800 452 4844	(fax) (82 2) 2004 5115
Canada:	Latin America:
(tel) 877 894 4414	(tel) (305) 269 7500
(fax) 905 282 6495	(fax) (305) 269 7599
China:	Taiwan:
(tel) 800 810 0189	(tel) 0800 047 866
(fax) 800 820 2816	(fax) 0800 286 331
Europe:	Other Asia Pacific
(tel) (31 20) 547 2323	Countries:
(fax) (31 20) 547 2390	(tel) (65) 6375 8100
Japan:	(fax) (65) 6836 0252
(tel) (81) 426 56 7832	Email:
(fax) (81) 426 56 7840	tm_asia@agilent.com

On-line Assistance:
www.agilent.com/find/assist

Product specifications and descriptions in this document subject to change without notice.

© Agilent Technologies, Inc. 2004
Printed in USA, February 17, 2004
5989-0563EN



Agilent Technologies