

Investigating Bluetooth™ Modules: The First Step in Enabling Your Device with a Wireless Link

Application Note 1333-2

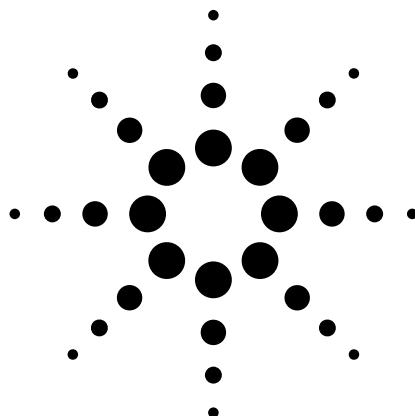

Introduction

Note: This Application Note is designed for vendors or manufacturers who plan to add a wireless link to their products by installing commercially-available, pre-built *Bluetooth* modules into them. It is addressed to a wide audience working in electronics whose knowledge and skills may vary, but assumes no specific knowledge of RF (radio frequency) techniques.

Bluetooth is an innovative new technology that provides wireless connectivity to a growing variety of electronic devices—computers, laptops, Personal Digital Assistants (PDAs), peripherals, cameras, cellular phones, pagers, and wireless headsets. Even use with home appliances such as refrigerators has been explored. With *Bluetooth* technology, small transceiver modules can be built into a wide range of products, allowing fast and secure transmission of data and/or voice within a given radius (usually 10 meters). Cables may soon be a thing of the past—for the first time ever, personal area networks can be created on an *ad hoc* or semi-permanent basis without cables or connectors and network administration problems.

Bluetooth operates in the 2.4 GHz ISM (Industrial, Scientific, and Medical) band, an unlicensed portion of the spectrum that is already well-used. Not only do microwave ovens operate within this range, but other RF communications technologies as well, most notable of which are HomeRF and IEEE 802.11b. Because this spectrum is unlicensed, even more uses for it are expected to be devised in the future. As the band becomes more widely used, radio interference will increase. To counter this interference, *Bluetooth* technology incorporates several techniques to provide robust linkages. Among these are cyclical redundancy encoding, packet re-transmission, and frequency hopping which can occur up to 1600 times per second.



Agilent Technologies

Originally conceived as a cable replacement, *Bluetooth* will obviously become much more as users continue to increase their reliance on information transfer and connectivity. *Bluetooth* is estimated to be installed in more than a billion devices by the year 2005! And it seems it is here to stay. It is currently the fastest-growing standard in the electronics industry. In short, *Bluetooth* technology is a key component of the wireless future (Figure 1).

Installing pre-built *Bluetooth* modules, as opposed to creating wireless

capability from scratch, has the advantage of requiring fewer resources, allowing shorter development times and enabling faster time-to-market. This option allows companies to gradually develop competence in installing *Bluetooth* modules while also gaining experience in marketing wireless products-or, alternatively, to leverage the expertise of their *Bluetooth* suppliers in enabling their products with a wireless link.

The purpose of this publication is to guide you on how to analyze *Bluetooth* modules, to discern which one will be

most suited to your type of device, and to anticipate the kinds of issues you could encounter in integration. By anticipating, investigating, and understanding these issues, you'll be in a much better position to integrate *Bluetooth* modules into your devices with a minimum of time, engineering effort, and cost. However, with a fast-changing technology such as *Bluetooth*, no publication can cover every contingency, so guidance at this point must be very general.

Figure 1. *Bluetooth* will connect together a growing universe of wireless devices.

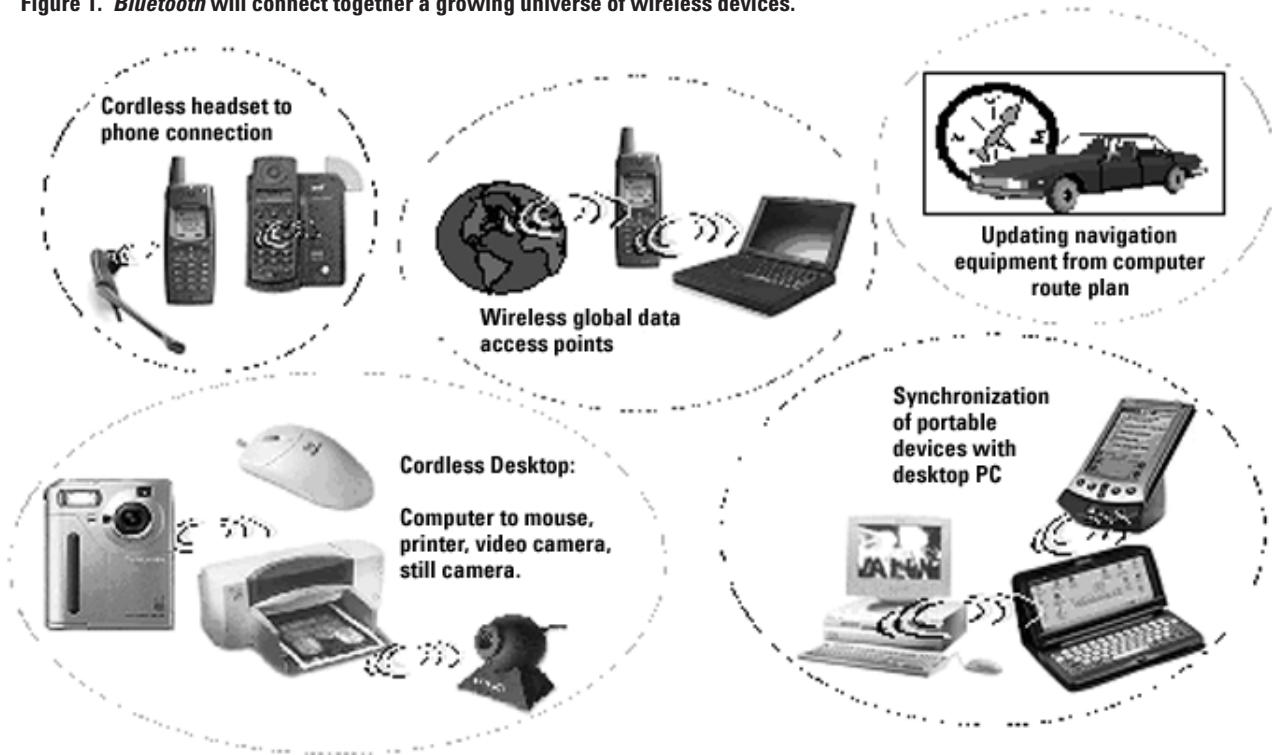

Table of Contents

Introduction	1	4. Pre-integration Factors	10
1. The <i>Bluetooth</i> Module	4	4.1 Power Supply and Battery	10
2. Type of Device	5	Battery Life	10
Category 1: Adapters	5	Power Consumption	10
Category 2: Appliances	5	Power Supply Noise	10
Category 3: Embedded Systems	5	4.2 Radiated and Conducted Interference	10
Category 4: Mobile Phones	5	Step 1. Analysis with a <i>Bluetooth</i> Test Set	11
3. Module Specification Issues	6	Analysis in Normal Mode	11
3.1 Module Capabilities	6	Analysis in Test Mode (Transmit Mode)	12
Size	6	Analysis in Test Mode (Loopback Mode)	13
Operating Temperature Range	6	Important Note: Link Establishment Problem	13
Operating Range	6	Step 2. Analysis with a <i>Bluetooth</i> Test Set and Spectrum Analyzer	15
Profile/Maximum Data Throughput/Packet Type	6	4.3 <i>Bluetooth</i> Interference with “Host”	15
Sensitivity	6	4.4 Antenna Radiation Pattern	16
Radio Performance	7	Appendix A : Agilent Test Equipment for <i>Bluetooth</i> Technology	17
3.2 Physical and Electrical Characteristics of Module	7	Appendix B : References	19
Physical Characteristics	7	For More Information	20
Electrical Characteristics	7		
3.3 Module Test Tools	8		
Test Access Points	8		
Test Mode	8		
3.4 Regulatory Approval	9		

1. The *Bluetooth* Module

A *Bluetooth* module consists primarily of three functional blocks—a RF transceiver unit, a baseband link controller unit, and a support unit for link management and host controller interface (HCI) functions (Figure 2). Another functional component is of course the antenna, which may be integrated on the PCB or come as a standalone item. A fully implemented *Bluetooth* module also incorporates higher-level software protocols (which can be resident in flash

memory) which govern functionality and interoperability with other modules. All *Bluetooth* modules have these same functional blocks, but different vendors' implementations will have different attributes such as size and degree of integration in silicon (e.g., single-chip solution vs. two or more chips).

The RF Transceiver specification defines the frequency bands, channel arrangement, and transceiver characteristics of a *Bluetooth* system. The

Baseband Processor specification defines packet formats, physical and logical channels, plus the different modes of operation which support the transfer of voice and data between devices. The Host Controller Interface (HCI) provides a common interface between the *Bluetooth* module and the host.

Bear in mind that all *Bluetooth* modules will need to pass the SIG qualification test, but this does not mean that they will all have the same characteristics.

Figure 2. Block diagram of a *Bluetooth* module, with two models shown.

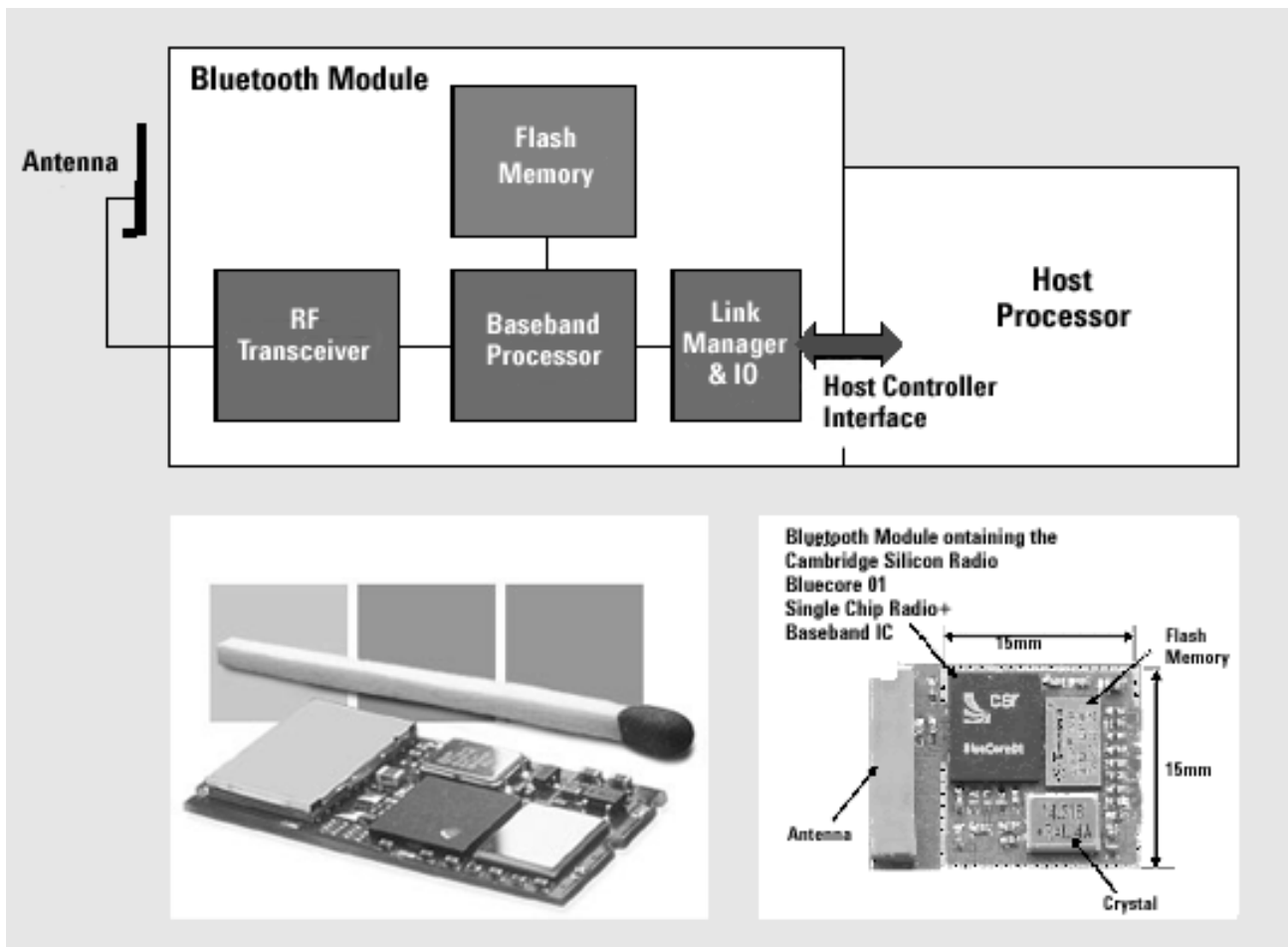

2. Type of Device

The target application for your *Bluetooth* module will be your first consideration. Quite simply, in what kind of device will you install your *Bluetooth* module? The usage model of the device will largely determine not only the electrical and physical environment in which the module is placed, but the primary factors to consider for integration as well. Among the growing classes of *Bluetooth* enabled devices are these:

Category 1: Adapters

PCMCIA card, compact Flash *Bluetooth* card, USB *Bluetooth* adapter, RS-232 *Bluetooth* dongle, *Bluetooth* printer port converter, etc. Such devices will allow you to add a wireless link to your existing desktop PC, laptops, personal digital assistants (PDAs), printers, etc. with *Bluetooth* technology.

Category 2: Appliances

Wireless headsets which send and receive audio signals to and from phones, cell phones, computer audio, MPEG players, home entertainment centers, etc., and computer peripherals such as keyboards, mice, joysticks, speakers and the like.

Category 3: Embedded Systems

The device will normally be a computer or peripheral, but in this case the *Bluetooth* module will be built directly into the device without using the interfaces of Category 1.

This category can include desktops, laptops, PDAs, or even printers, scanners and fax machines. Obviously, it can overlap with Category 2 or 4. PCs eventually will have *Bluetooth* circuitry directly on the motherboard.

Category 4: Mobile Phones

Bluetooth capability can be added to mobile phones in several ways—for example, via battery packs, adapters, or direct integration into the host. Hence this category can be a special instance of Category 1 or Category 3 but because of the expected market penetration, is treated as its own class.

Having a full understanding of the device you plan to convert to wireless will make it easier to define the specifications of the *Bluetooth* module you need, what performance factors you should consider, and what kind of tests you may need to perform.

The following table (Table 1) provides an overview of some module specification and pre-integration issues you should consider and analyze in preparing for proper integration of a module into your device. The list is not meant to be exhaustive. Please note that specifications can be provided by the manufacturer, while analysis of pre-integration factors may require specific measurements to be performed.

We will now look at these topics in more detail.

Table 1. Module Specification Issues and Pre-integration Factors

By *Bluetooth* Device Category

	Category 1	Category 2	Category 3	Category 4
Module Specification Issues-Information can be provided by your supplier.				
Size	◆	●	◆	●
Operating Temperature Range	●	◆	●	●
Operating Range	◆	◆	◆	◆
Sensitivity	●	●	●	●
Profile /Maximum Data Throughput / Packet Type	●	◆	●	◆
Radio Performance	●	●	●	●
Physical & Electrical Characteristics	◆	◆	◆	◆
Test Mode	◆	◆	◆	◆
Test Access Points	◆	◆	◆	◆
Regulatory Approval	◆	◆	◆	◆
Pre-integration Factors-Analysis may require you to do specific measurements.				
Battery life	I	●	I	●
Power consumption	◆	◆	◆	◆
Power supply noise	●	I	◆	I
Radiated interference	●	●	●	●
Conducted interference	●	●	●	●
BT interference with "host"	I	◆	I	●
Radiation pattern	●	●	●	●

● indicates that you should analyze this specification or pre-integration factor.

◆ indicates that you should think about it.

I indicates that you need not be concerned with it.

3. Module Specification Issues

Technical performance specifications of a *Bluetooth* module will usually be provided by a vendor's data or spec sheets. The specifications mentioned in this section should be considered in detail to ensure proper operation of the module in your final device.

3.1 Module Capabilities

Size

Obviously, a *Bluetooth* module must *fit* physically into its host device, preferably with as little modification to device design and manufacture as possible.

Operating Temperature Range

The behavior of a module, and consequently of your device, can be affected by high temperature (coming from a power supply, as in Category 1 and 3) or by low temperature (mobile phone used in a really cold environment, Category 4). Temperature can have a different effect depending on the electrical characteristics of the module (analog or digital design). Digital circuits will make occasional errors at high and low temperatures, and eventually cease to function when temperature stress is sufficient. With analog circuits, such as RF amplifiers and voltage controlled oscillators (VCOs) etc., degradation is likely to be more gradual and continuous. If, for example, a reference oscillator in the transmitter or receiver drifts, it may not seem to affect the working of the module at all. However, the bit error rate (BER) of the link may be greatly affected, since the transmitted frequency has drifted. That is why it is important to check to see if the *Bluetooth* module has the right temperature specifications to support the temperature of the environment of your device.

Operating Range

Bluetooth modules transmit between 10cm and up to 100m according to their Transmit Power Class: Power Class 1 (+20dBm max power, 100m max range), Power Class 2 (+4dBm max power, 10m max range), Power Class 3 (0dBm max power, 10m max range). Be sure to check that the module you're considering will operate over the range you need. You should not use a Power Class 1 module if you want to maximize the battery life of your device (Category 2 and 4). On the other hand, it may be exactly the power class you want if a maximum range is required.

Profile/Maximum Data Throughput/Packet Type

The usage model of your device will determine the appropriate profile (Reference 2) you should pursue. The profile will determine the type of data transfers likely—for example, a printer will not use voice data transmission and will likely run in asymmetrical mode.

With profiles, the issues of synchronous vs. asynchronous as well as symmetrical vs. asymmetrical links will be raised. The asynchronous channel can support an asymmetric link of 721kB/s maximum in either direction, while permitting 57.6kB/s in the return direction, or 433.9kB/s symmetric. The synchronous channel can support 64kB/s in each direction.

For *synchronous links*, reserved for synchronous voice connections, some subjective listening tests (Reference 4) indicate that the HV3 packet type is the most robust.

Similarly, for *asynchronous links*, reserved for data connections, some analyses (Reference 4) show the following:

- DH5 packet type is best for low levels of interference
- DH3 packet type is best for the majority of interference
- DH1 packet should be used only in low bandwidth (<200kB/s) applications

Thus, depending on the type of device you intend to enable, it is important to know if your *Bluetooth* module will provide you with the right data throughput and support the right packet type.

For details about the definition of the different packet types, refer to *Specification of the Bluetooth System* (Reference 1).

Sensitivity

Sensitivity of the product enabled with *Bluetooth* technology may be a major issue confronting a product designer. Sensitivity specifications of a *Bluetooth* module are likely to be under *optimum conditions*—any implementation will probably result in a degradation in the sensitivity figure as specified for the module itself. Real-world operating conditions both inside and outside the device—such as high RF noise, metallic shielding, or high temperatures—can badly reduce sensitivity.

Some *Bluetooth* modules may actually exceed the *Bluetooth* specification for sensitivity, but check to see that this is not compromised as you progressively integrate the module into its host device. Sensitivity should be verified not only at the outset, but throughout the integration and test cycle of the device. Various tests can be performed to analyze and anticipate the degradation of the sensitivity of the module during implementation and determine if the module still meets the sensitivity specifications goal for the target device (see “Pre-integration Factors,” Part 4.2, “Radiated and Conducted Interference”).

Radio Performance

If the information is available, you should check the radio interference rejection of your module. This specification can vary depending on how the radio receiver was designed. The performance specified by the *Bluetooth* Special Interest Group (SIG) (Reference 1) is:

- Co-channel interference: 11dB
Interferer is in the same channel at 11dB below the wanted signal.
- Adjacent channel interference rejection: 0dB
Interferer is in the adjacent channel at the same power level as the wanted signal.

Some *Bluetooth* modules will have more robust radio performance than others. A high-performance radio might have the following specifications:

- Co-channel interference: 8dB
Interferer is in the same channel at 8dB below the wanted signal.
- Adjacent channel interference rejection: -10dB
Interferer is in the adjacent channel at +10dB above the wanted signal.

Example: Using these two levels of performance as an example, an experiment (Reference 4) was done in which the following measurements were taken:

- Degradation of link performance in the presence of interference
- Throughput in the presence of a specific amount of interference
- Throughput as a function of range

The results were as follows:

- The number of piconets that could be established before the aggregate throughput started to decrease was improved from 20 (with a standard radio) to 40 with the high-performance radio.
- Throughput performance in the presence of interference was substantially increased
- The maximum range doubled

These differences show that it is essential to consider radio interference rejection specifications in characterizing a *Bluetooth* module.

If, for any reason, these specifications are not provided by a supplier, you can determine them by performing a C/I (Carrier-to-Interference) performance test. C/I performance is measured by sending co-channel or adjacent channel *Bluetooth* modulated signals in parallel with the desired signal and then measuring the receiver's BER. This test can be accomplished by using two signal generators, both supporting *Bluetooth* capabilities and one supporting BER measurement (for example, an Agilent ESG-D series signal generator with optional *Bluetooth* personality and internal BER analyzer). For more information, refer to Agilent Application Note # AN 1333, *Performing Bluetooth RF Measurements Today* (Reference 5).

This test could also be performed by using a *Bluetooth* test set (for example, Agilent E1852A) for the desired signal and a signal generator for the interfering signal.

3.2 Physical and Electrical Characteristics of Module

Even if physical and electrical characteristics are not primary issues in developing your device, you should be aware of them in considering *Bluetooth* modules.

Physical Characteristics

Some *Bluetooth* suppliers have chosen to adopt a multi-chip design, employing CMOS devices for the baseband DSP and microcontroller and bipolar devices for the RF functions. Other vendors have taken a radically different approach with a complete, single-chip *Bluetooth* solution fabricated entirely in CMOS. You should be aware of the physical characteristics of your module in case you experience problems during or after manufacturing test—how easy will it be to repair or replace the module, assuming a cheap replacement is not available?

More significantly, you will notice that physical characteristics will have an influence on electrical characteristics of your module. For example, to be able to increase the level of circuit integration, several designers have chosen a quadrature mixing design (IQ modulator/digital demodulator design), moving signal processing into DSP and away from analog circuits.

Electrical Characteristics

Bluetooth radios cover a wide range of electrical design, from direct frequency modulated VCO/analog discriminator (Figure 3) to IQ modulator/digital demodulator designs (Figure 4). Each design can have distinct advantages, such as better interference rejection or longer battery life or simply early delivery. While each supplier will certify its *Bluetooth* analog and digital modules, the test results you obtain may be different.

That is why it is so important to understand what normal stand-alone module behavior looks like—before integrating it into your device. For example, if you check the modulation characteristics (Initial Carrier Frequency Tolerance and Frequency Drift) of an IQ modulator/digital demodulator design, you may notice that the signal looks bumpy due to IQ imbalance (Figure 6, page 9). This is not likely to happen with a frequency modulated VCO/analog discriminator design (Figure 5, page 9).

3.3 Module Test Tools

To be able to test the module (if needed) and your device after integration, you should check which access points are available on the *Bluetooth* module and if the module supports “Test Mode”.

Test Access Points

Access points are typically the Host Controller Interface (HCI), the RF Interface, and the RF-to-Bandwidth Controller Interface. Access points can be provided by either hardware or software.

If you want to perform certain tests on the module (for instance, analyzing pre-integration factors, as in Part 4), you should make sure that you at least have access to the RF interface (via an RF connector if possible). If you don't have a module fixture, you can check with the module manufacturer to see if an evaluation board is available to test the module in your device's environment. Some companies are providing these for early stages of integration.

Test Mode

Test Mode gives you the choice of having a *Bluetooth* module transmit a defined packet (Transmit Mode) or retransmit received data (Loopback Mode), with control of different parameters such as bit pattern, frequency selection, Tx frequency, and poll period. Having this capability will make the detection of problems easier and will expedite testing of both the *Bluetooth* module and finished device. Test Mode should be supported by any *Bluetooth* module, since it is mandated in the *Bluetooth* specifications. It could be, however, that some modules do not yet support this feature.

Figure 3. Direct frequency modulated VCO/analog discriminator block diagram.

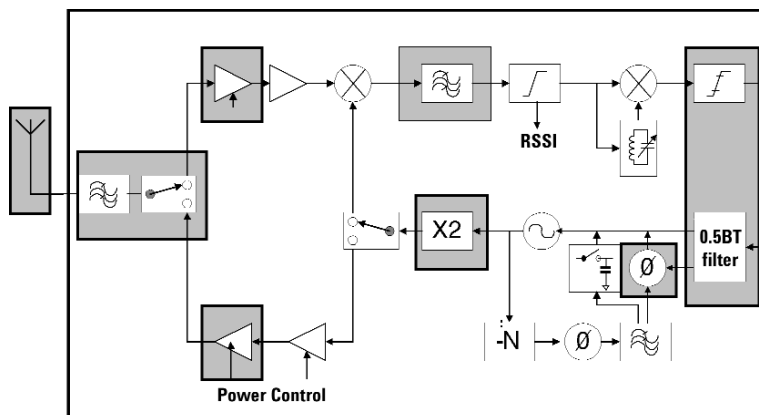
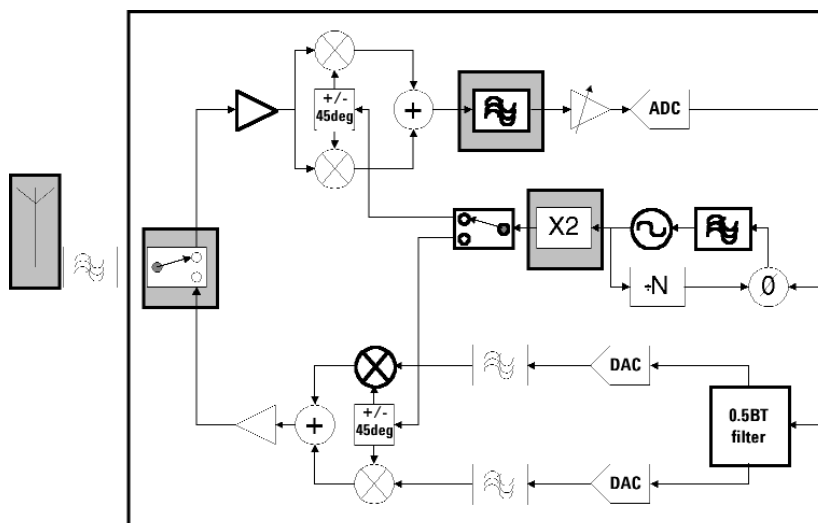

Figure 4. IQ modulator/digital demodulator block diagram.



3.4 Regulatory Approval

The type of regulatory approval used to certify the module is not exactly a module specification issue, but it is a factor that you should take into account for future tests and certification of your device. You must know which regulatory agencies and certification bodies a supplier has consulted to certify his *Bluetooth* modules. For example, modules destined for the European Union (EU) must comply with the RTTE Directive (Radio Telecommunications Terminal Equipment), while the FCC (Federal Communications Commission) and a Telecommunications Certification Body (TCB) must be consulted for the certification of modules destined for the USA. Each certification agency will have its own regulatory requirements. Hence, when you choose your *Bluetooth* module, it is your responsibility to know the various global regulatory requirements and adhere to them in marketing your *Bluetooth* devices.

By evaluating all of the specifications, you will know, or at least have a better grasp of, which *Bluetooth* module(s) is best adapted for your device. Knowing the module has been certified by the supplier and works as specified, you should be ready to integrate the module into your device.

However, to make an even more informed choice, or to anticipate the kinds of problems that can occur during integration, some pre-integration factors should also be analyzed. These factors are primarily power supply noise, power consumption, battery life, radiated and conducted interference, *Bluetooth* interference with “host,” and antenna radiation pattern. You should investigate these factors *prior* to integrating a *Bluetooth* module into your device. Part 4 will provide you with more information about these factors and the type of measurements you may perform.

Figure 5. Agilent E1852A display showing a modulation measurement of a *Bluetooth* module designed with a direct frequency modulated VCO/analog discriminator.

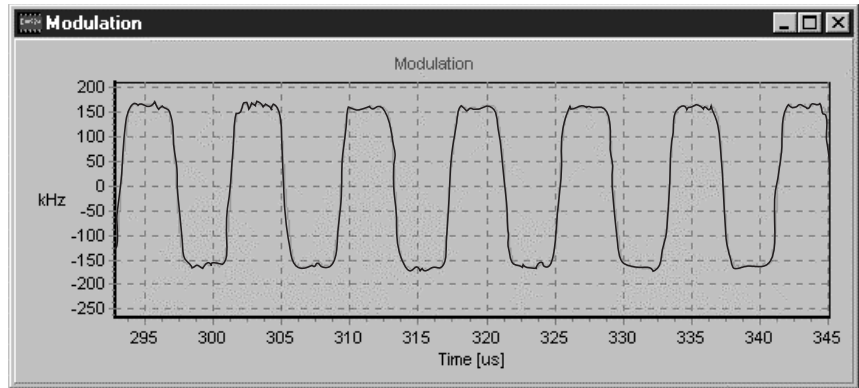
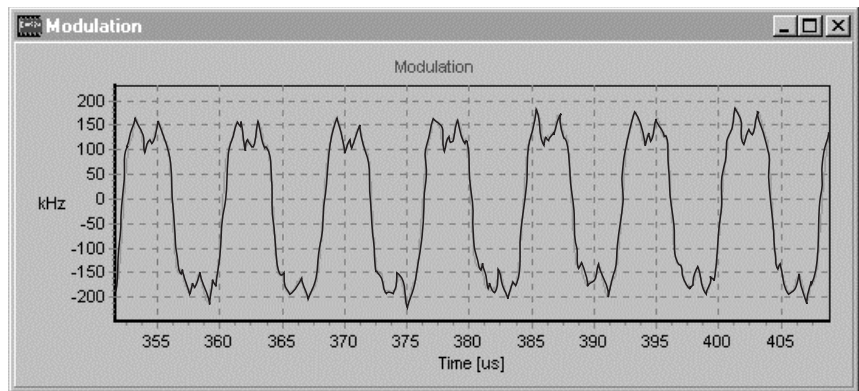

Figure 6. Agilent E1852A display showing a modulation measurement of a *Bluetooth* module designed with IQ modulator/digital demodulator.



4. Pre-integration Factors

Pre-integration factors cannot be analyzed just by reading the module datasheet or information which the supplier provides. If you want to optimize their analysis and anticipate the problems that could be generated during your integration, you will need to perform certain measurements. As mentioned before, the list of pre-integration factors is not intended to be a *complete* list of all the issues that you should investigate to ensure that the *Bluetooth* module you're considering will work after integration into your device. But it is an excellent place to start.

4.1 Power Supply and Battery

Battery Life

If you are adding *Bluetooth* capability to a battery-powered device (Category 2 and 4), it is important to know how various *Bluetooth* modules will be affected by battery conditions. By using a DC source that can duplicate the performance of your device's battery, you can analyze the behavior changes of a *Bluetooth* module using a signal analyzer (see Figure 7 for an example of measurement setup and Figure 8 for a list of parameters that could be analyzed).

Power Consumption

The data sheets of *Bluetooth* modules should provide you some standard power consumption characteristics. However, it could be that they will not provide some specific characteristics, such as peak power consumption.

Some DC sources will have the capability of doing current measurements. With this feature, you can analyze how much current the *Bluetooth* module consumes, what its peak power consumption is, and, based on the result, determine if the battery or power supply of your device will handle that peak consumption. If possible, you should ensure that the power consumption of the *Bluetooth* module is only a small fraction of that of your host device.

Power Supply Noise

A power supply can generate considerable RF noise. Hence, it is important to analyze how the power supply of your device (Category 1 and 3) will influence a *Bluetooth* module—for example, how well your power supply is decoupled. Measurements of power versus time during DH5 bursts and careful monitoring of the frequency error measurements (Figure 11) can uncover DC bias power-related problems. Noise may be seen as a ripple in the Frequency Drift measurement (Figure 10).

Agilent Technologies offers a complete line of DC power supplies suitable for testing these kinds of power supply/battery issues. The Agilent 66319/21 Mobile Communications DC Sources, for example, provide features designed specifically for wireless testing. These include fast transient response and low-current measurement capability (useful for evaluating current consumption), as well as programmable output resistance that allows you to do accurate emulation of particular battery characteristics.

4.2 Radiated and Conducted Interference

Keep in mind that the *Bluetooth* module you're going to buy has been certified and works in stand-alone mode. Your goal should be to determine if the module still works properly in the environment of your device. Hence, you must try to determine the type of interference the device and its larger environment can create. Radiated interference can come from virtually anywhere—a system working in the ISM band IEEE 802.11b, HomeRF, microwave ovens, etc.); a system working in another band (GSM, UMTS, etc.); a power supply; Local Oscillators (LOs) of a cell phone; or digital noise of a PC, PDA, or other electronic device.

Conducted interference can come from a power supply, clock circuit, or other application components. If your device is a PCMCIA card, data buses can interfere, and more generally, digital control lines. Long cables between modules can also be pathways for conducted interference.

The ideal situation would be to simulate your device's total working environment, which is very complex. More realistically, you should try to place the *Bluetooth* module in your host device (via a fixture) and get the device to do some "work." For example, if your device is a mobile phone, make a telephone call. If your device is a PCMCIA card, calculate some large numbers in Excel, start a video signal, or download a file over the LAN. The idea is to get the host to produce as much electrical noise as possible consistent with its normal operation.

Then, to optimize the analysis of the module's behavior in your device, you could perform the following steps:

Step 1.
Analysis with a Bluetooth Test Set

Analysis in Normal Mode

- With a *Bluetooth* test set, establish a normal link with the *Bluetooth* module via a wire (or antenna if the wire connection is not possible) (Figure 7).
- Analyze the results. For instance, if you use the Agilent E1852A *Bluetooth* Test Set, check to see if there are any red bars shown on the Measurement Summary window (Average Power, Peak Power, Frequency Offset, Frequency Deviation, Frequency Drift, Packet Error Rate; see Figure 8).

Figure 8. The Agilent E1852A *Bluetooth* Test Set features a Measurement Summary window which offers instantaneous readouts of each measurement parameter, plus easy-to-read pass/fail indicators.

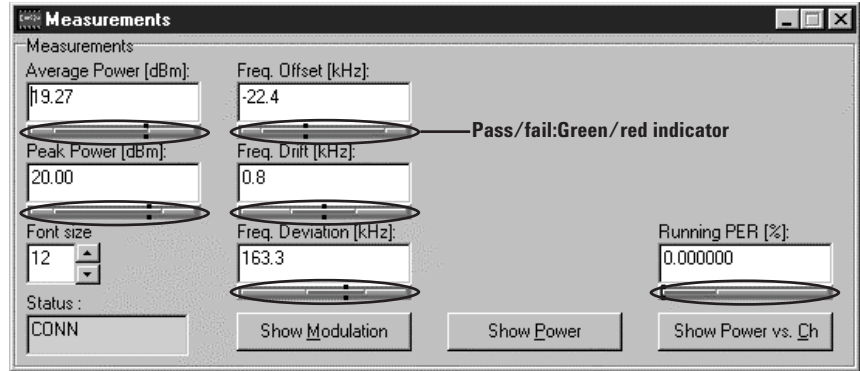

Figure 7. Setup of normal link between an Agilent E1852A Bluetooth Test Set and a *Bluetooth* module placed in its device environment.

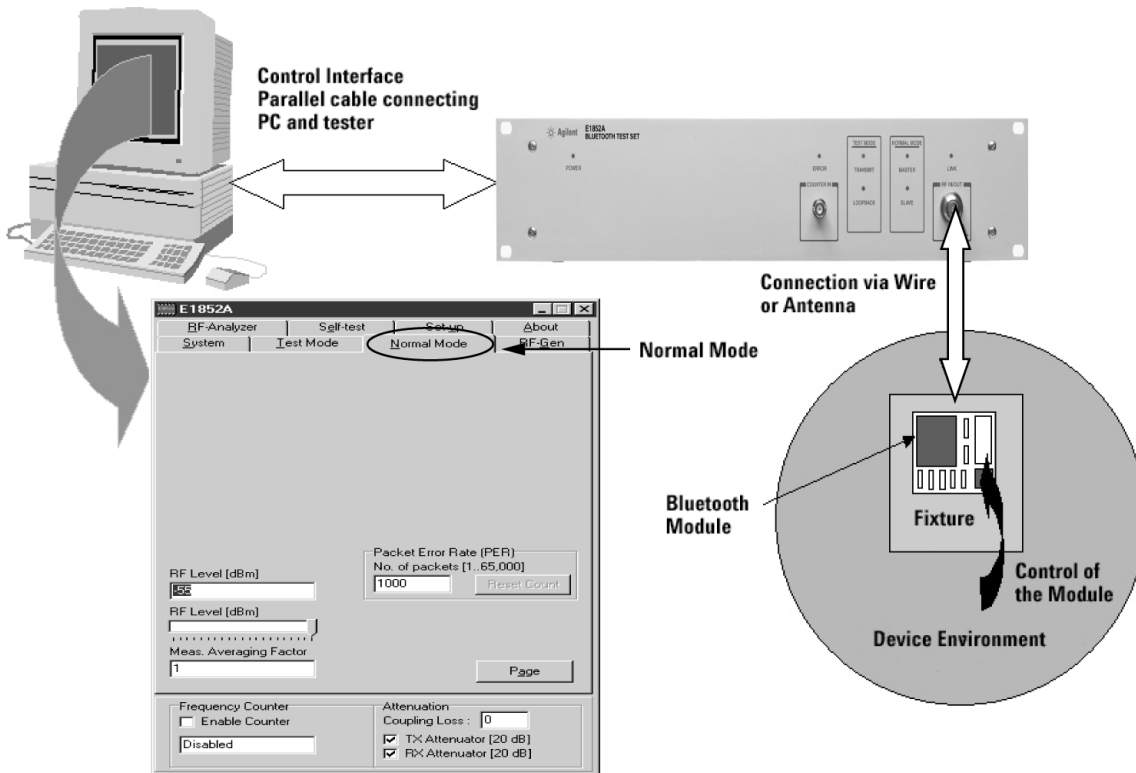

Figure 9. Agilent E1852A display showing a repartition of the power on the 79 Bluetooth channels.

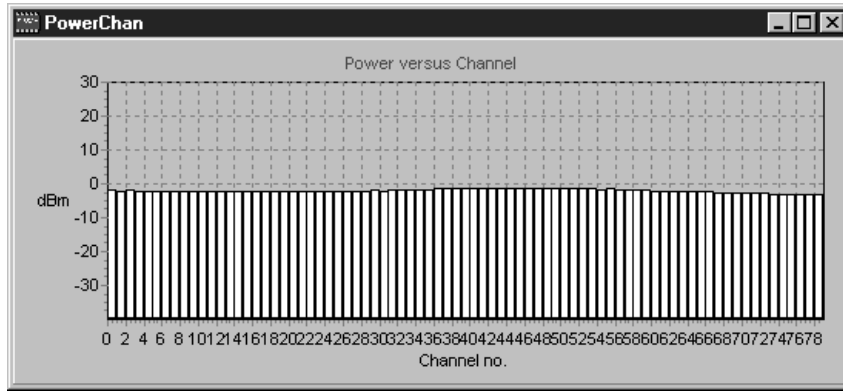

Figure 10. Agilent E1852A display showing a modulation analysis (frequency versus time). Setup uses a DH5 packet with a bit pattern of Constant One and a maximum length payload (339).

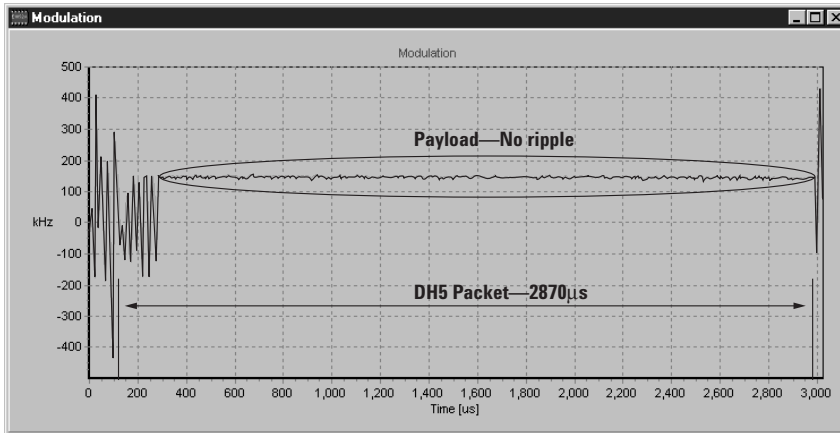
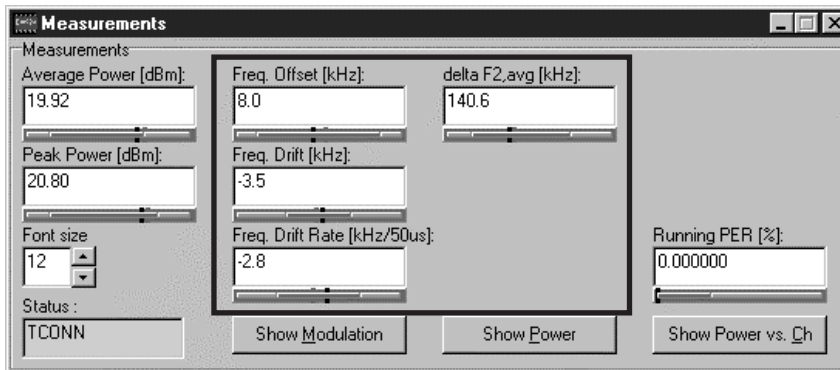

Figure 11. Agilent E1852A display showing the parameters ICFT (Frequency Offset), Frequency Deviation, and Frequency Drift which you should analyze.



- Then drop the power and see if the PER (Packet Error Rate) gets affected at the expected level. This test will allow you to check how much the sensitivity of the module has been degraded by implementing it into your device environment.
- Analyze the “Power versus Channel” measurement and check to see if all the channels have been used. They should be equally used if you have a wire connection (Figure 9).

If you notice any errors or anomalies, investigate them by analyzing the Bluetooth module in Test Mode (Transmit and Loopback Modes).

Analysis in Test Mode (Transmit Mode)

Go to Test Mode and get the module to transmit 11111111 on a DH5 packet if possible. Using the longest packet with a bit pattern of Constant One will make the analysis of results easier. You should look for evidence of a ripple on the modulation graph (Figure 10). Similarly, bad numeric results for Frequency Drift or Frequency Deviation could indicate problems (for this measurement you will need to use a bit pattern such as 11110000 or 101010101; see Figure 11). The main VCO is usually shared between the transmitter and receiver paths. If you don’t get errors in Transmit Mode, it will probably mean that you will not get errors in the receiver tests (Loopback mode). However, there may be other ways in which conducted interference could get into the demodulated signal.

Analysis in Test Mode (Loopback Mode)

Go to Loopback Mode and perform a BER measurement. Drop the power level down and see if the sensitivity is as good as it was when you measured the module by itself (Figures 12 and 13). If it is not, it indicates that a radiated or conducted signal is desensitizing the receiver.

Important Note: Link Establishment Problem

In performing some of the tests above, you may experience problems in the establishment of a link between the *Bluetooth* module and the *Bluetooth* test set. This could be due to either a hardware problem or firmware problem with the module (for example, the *Bluetooth* module version may not be consistent with the version of the tester).

Figure 12. Picture of three Agilent E1852A displays showing a BER measurement done at three different power levels (-35dBm, -69dBm, -75dBm)

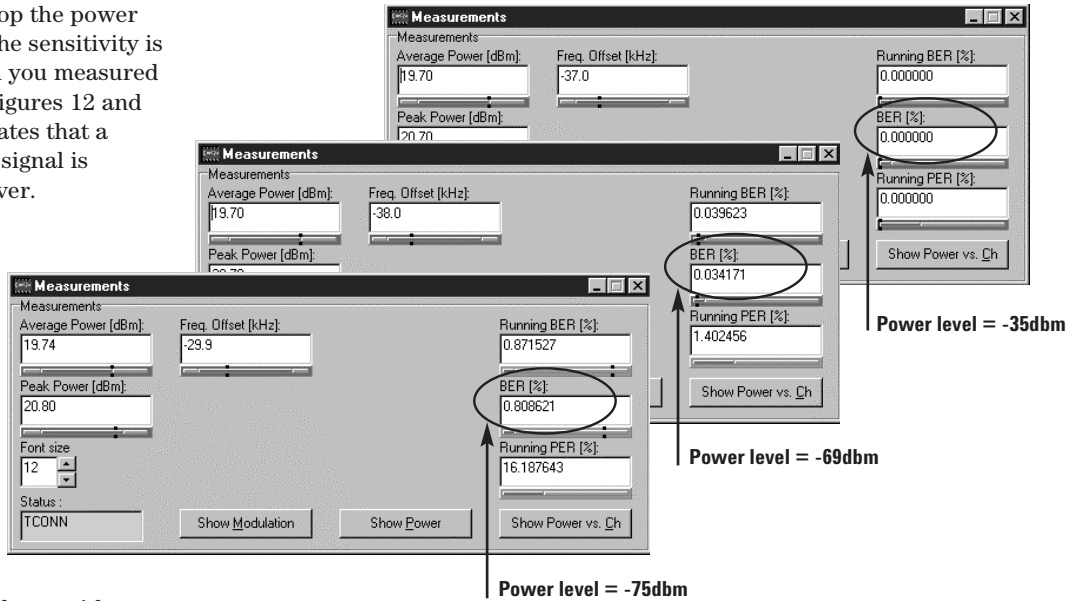
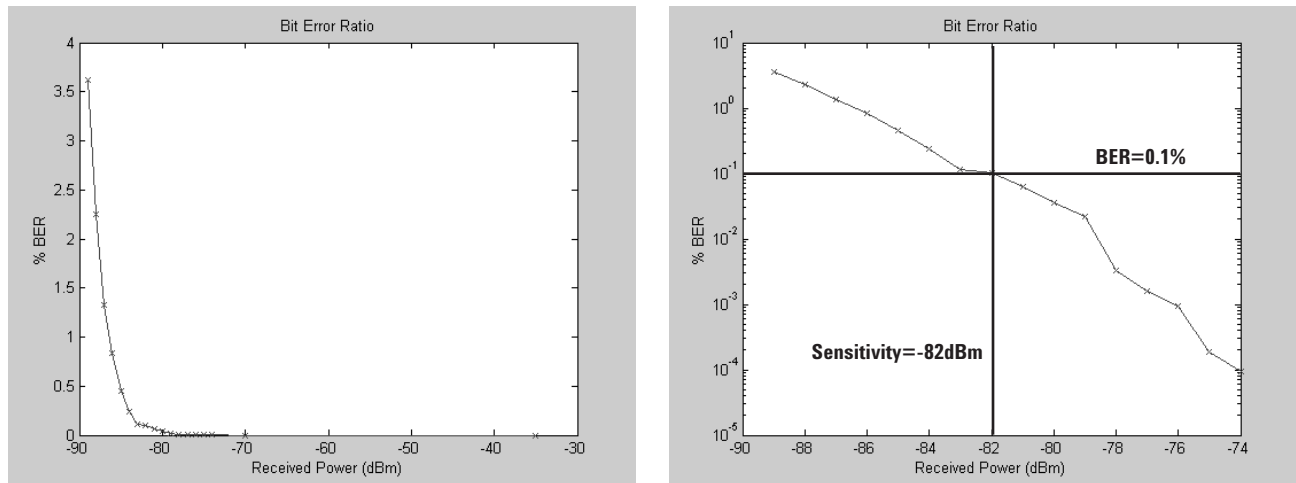

Figure 13. Graphics (in linear and logarithmic scale) of a *Bluetooth* module's BER measurement as a function of received power level



To detect where the problem comes from, you can use the “Test facilities” utility of the *Bluetooth* module (if it is implemented). This utility has the ability to make the *Bluetooth* module act like a transmitter or like a receiver. By putting the module in the transmit mode, you can check to see if a *Bluetooth* signal is being generated by the module. The measurement can be performed using a spectrum analyzer supporting a *Bluetooth* personality (for instance, Agilent ESA series

with Option 303 or 304) or an Agilent E1852A Bluetooth Test Set by using its “RF-Analyzer” capability. Using this capability will provide you the same measurement parameters you get when you establish a real link (Figure 14).

You can also use the utility to make the module act as a receiver. In this case, you could generate a *Bluetooth* signal using a signal generator, inject the signal into the *Bluetooth* module, and read the BER measurement with

the utility. By performing this test, you’ll have a good idea whether the problem comes from the module’s hardware or its firmware. If you don’t get a problem in using this utility but the measurement results are wrong, it means that you probably have a firmware problem. Conversely, if you can’t generate or receive a signal using this utility, you probably have a hardware problem.

Figure 14. Agilent E1852A display showing “RF-Analyzer” menu and a list of measurement parameters you get by using this menu.

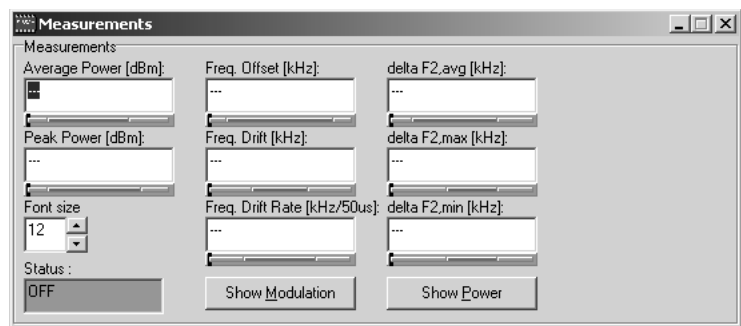
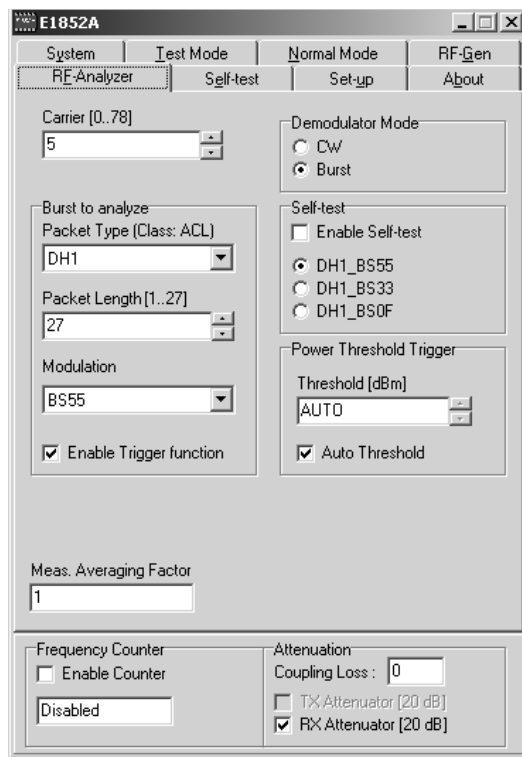
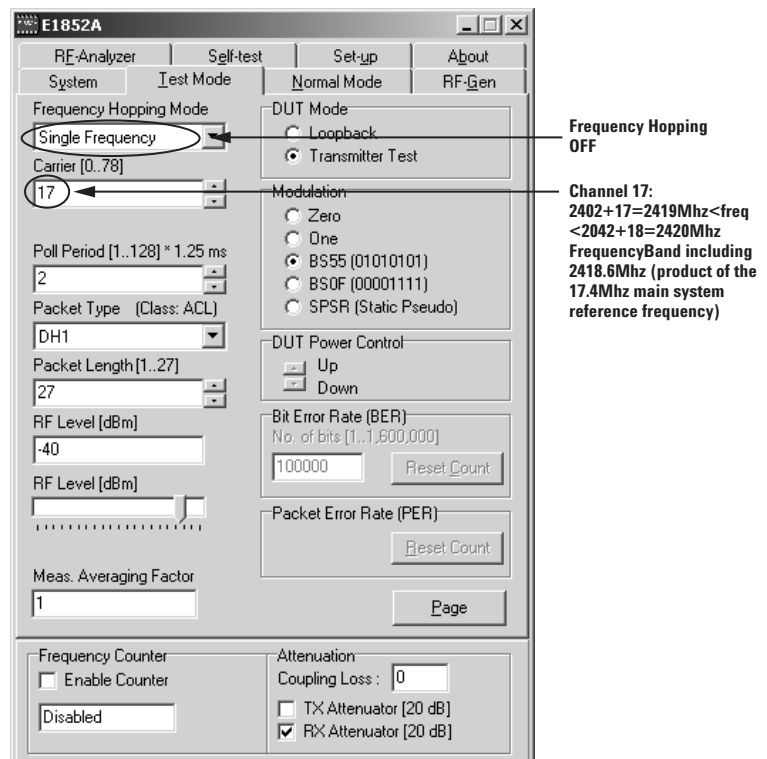

Figure 15. Agilent E1852A display showing configuration of the Test Mode menu for a single frequency in Channel 17.



Step 2. Analysis with a *Bluetooth* Test Set and Spectrum Analyzer

If you have a spectrum analyzer, use a close field probe to check your host device for main system reference frequencies, using the device's block diagram as a guide. Once having determined a frequency (for example, 17.4MHz), multiply it by a number n so that it falls within the 2.4GHz (2402-2483.5MHz) band. (For example, $17.4\text{MHz} \times 139 = 2418.6\text{MHz}$). Repeating this procedure, find all of the *odd* harmonics of each reference frequency within the band (they have a larger influence than even harmonics). For each calculated frequency, configure the *Bluetooth* test set to establish a link in Test Mode (frequency hopping OFF, see Figure 15, page 14) with the desired channel and see if there is any change in the behavior of the *Bluetooth* module. For any given system reference frequency, you may need to test several frequencies in the 2.4GHz band. For example, there are two odd harmonics of 17.4MHz within the 2.4GHz band: 2418.6MHz and 2453.4MHz, n being 139 and 141.

This test provides another way for you to see if radiated and conducted interference coming from your device will affect the *Bluetooth* module.

4.3 *Bluetooth* Interference with "Host"

Bluetooth module behavior can be affected by the environment of its device, and conversely, RFI (radio frequency interference) from the *Bluetooth* module can affect the performance of the host, especially if it generates its own RF emissions or has its own receiver (e.g., cellular phones).

By having been certified, a *Bluetooth* module should have passed "out-of-band spurious emissions" tests. These tests involve measuring conducted emissions (antenna or output connector) and radiated emissions generated by the *Bluetooth* module. The exact specifications the module must meet will depend on where it is used, e.g., USA or Europe (see Part 3.4, "Regulatory Approval").

Ordinarily, a certified *Bluetooth* module should *not* affect your host device. However, if your device has a receiver and you have a spectrum analyzer, it is beneficial to look for possible spurious emissions from the *Bluetooth* module. To do so, establish a normal link between the *Bluetooth* test set

and the *Bluetooth* module over the air. And by using a spectrum analyzer with an antenna (Figure 16), you can analyze the spurious emission of the module (Figure 17). An Agilent ESA-E Series will allow you to do some measurements up to 26GHz if needed.

The *Bluetooth* signal shown in Figure 17 did *not* fail the certification test, but obviously multiple signals have been generated. You should make sure that these signals will not have any influence on your device or its environment.

Figure 16. Picture of Agilent ESA-E spectrum analyzer receiving a *Bluetooth* signal over the air using a RangeStar *Bluetooth* antenna



Figure 17. Agilent ESA-E spectrum analyzer display, showing a spurious analysis in the 12.5 GHz band.

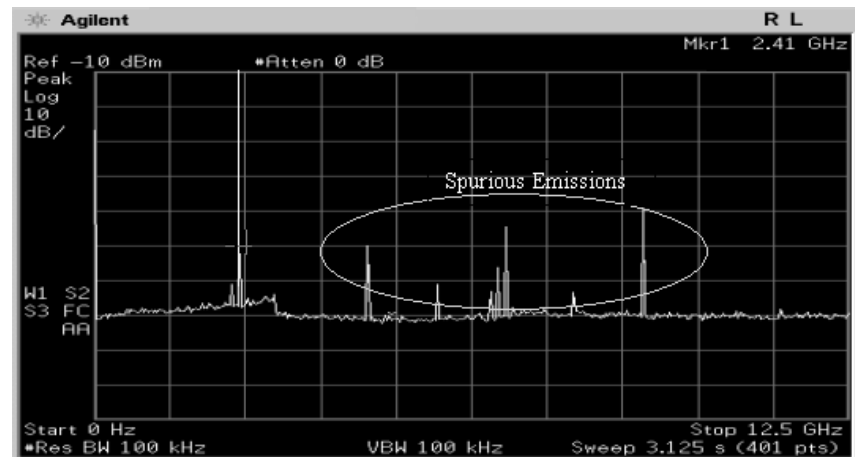

4.4 Antenna Radiation Pattern

As mentioned in Part 1, certain suppliers may provide modules with an integrated antenna. If you choose such a module, you should determine if the antenna provided will be appropriate for your device. Similarly, if you choose a module without an antenna, you must decide which type of antenna you will integrate into your device.

A high-quality radio link requires the sufficient link gain and desired pattern of radiation. Loss of gain reduces transmitter-coverage area. Alternatively, if the loss is compensated by increasing transmit power, it will reduce the *Bluetooth* device's operating time and/or power efficiency. Gain is affected by losses in the circuit, including mismatch loss (for example, the antenna does not look similar to 50 Ω). If the antenna is not placed close to the power amplifier (PA), losses can occur in the printed

circuit board (PCB) or transmission line and connector mismatch losses leading to the antenna.

Gain also varies with the radiation pattern. Radiation patterns often have nulls, or areas where gain is low (Figure 18). For example, a *Bluetooth* desktop device should ideally have a hemispherical circularly polarized pattern, but not all the antennas provide this. This ensures that compatible devices will work at any angle and polarization above the desktop. The antenna-radiation pattern (and therefore, gain) is affected by the proximity of other objects. If the antenna is not placed appropriately, nulls can form so that communication is poor or impossible in certain orientations.

Whether the antenna is integrated into the module or not, the above issues should be checked.

A basic test can be performed to detect radiation pattern problems.

Similarly to the description of Part 4.2 tests, put the module into its device fixture and establish a normal link with a *Bluetooth* test set over the air. Move the *Bluetooth* device around (if you can!), or the *Bluetooth* test set, and analyze the power measurement (Figure 19). Check to see if the power drops.

Figure 18. Example of a radiation pattern diagram: A polar diagram of a dipole antenna showing area with low gain or nulls.

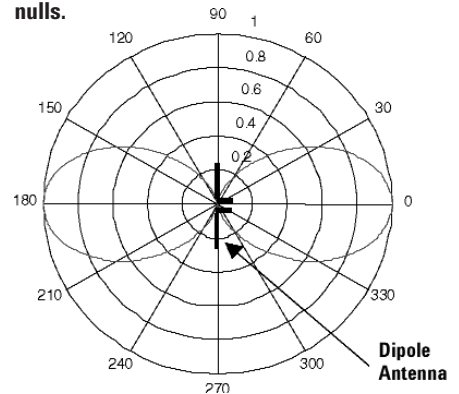
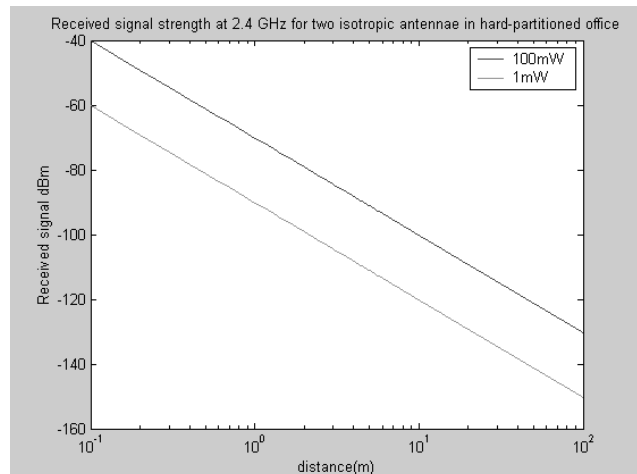
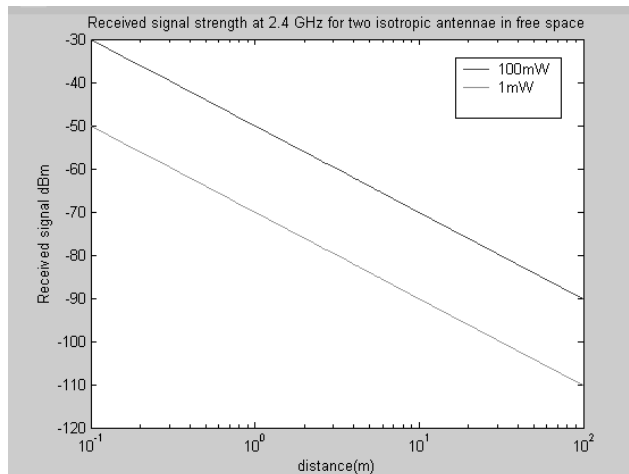

Figure 19. Graphs showing how a received power signal changes theoretically with distance. Left graph shows the result of two *Bluetooth* modules placed in a hard-partitioned office. Right graph shows the result of two *Bluetooth* modules placed in free space.



Appendix A. Agilent Test Equipment for *Bluetooth* Technology

Test Equipment with *Bluetooth* Capability

E1852A *Bluetooth* Test Set

Has the ability to establish a link using standard *Bluetooth* protocol and verify the performance of *Bluetooth* transceivers.

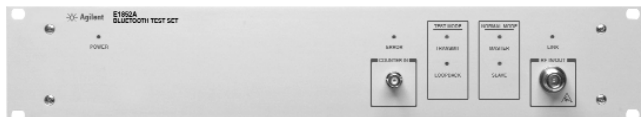

Signal Generators, ESG-D Series (3-4GHz), Option UND, UN7, UN8

Bluetooth signal for transmitter tests, custom *Bluetooth* modulated interference signals for receiver testing, *Bluetooth* receiver BER analysis.



Spectrum Analyzer, ESA-A Series (3-26GHz), *Bluetooth* Bundles (Option 303, 304)

Automated “one button” test execution for *Bluetooth* transmitter measurements. Performs a broad range of spectrum measurements.



EPM Power Meter and E9320 Power Sensors

Make quick, easy, and accurate *Bluetooth* transmitter power measurements.



Simulation Software, ADS with *Bluetooth* DesignGuide

Useful software tool for the design and simulation of custom *Bluetooth* systems. Pre-defined *Bluetooth* component models to speed the simulation process. Can be linked with the ESG-D Series and 89600 Series.



Other Test Equipment

Vector Signal Analyzers, 89400/89600 Series

Versatile and precise signal analysis, with complete *Bluetooth* transmitter measurements. Provides modulation quality analysis for *Bluetooth* signals, including constellation and eye diagrams.

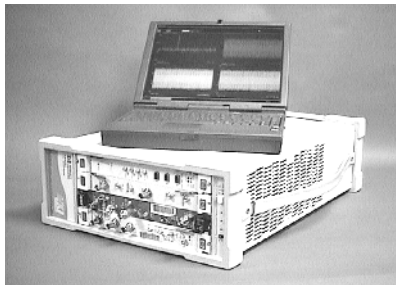

DC Sources, 66319B/D

Fast programmable dynamic DC power sources with battery emulation.



Logic Analyzers, 16700 Series

Provides comprehensive system-level debugging for multiple processor/bus designs.

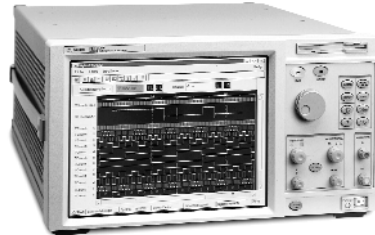

Mixed Signal Oscilloscopes, 54620 Series

Useful for verification and debugging of *Bluetooth* baseband signals.

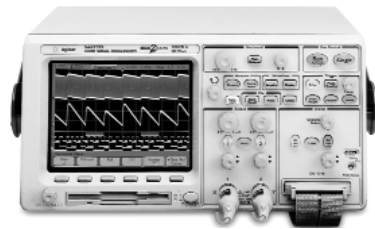

Network Analyzers, 8753E Series

Provides measurement of Antenna VSWR.



Accessories

Oscilloscope Probe–54006A

Passive probes with very low capacitance (0.25pF).

Close Field Probe–11940A

Measures magnetic field radiation up to 1GHz.

Splitter–11667A

Useful for ratio measurements and equal power splitting.

Directional coupler–773D

Useful for monitoring one RF waveform while two *Bluetooth* devices are connected by cables.

Dual directional coupler–772D

Useful for monitoring both RF waveforms while two *Bluetooth* devices are connected by cables.

Appendix B. References

The Official Bluetooth Website, www.bluetooth.com, includes information on *Bluetooth* history, technology, news, specifications, applications, products, events, and *Bluetooth* Special Interest Group (SIG).

1. *Specification of the Bluetooth System* - version 1.1, Volume 1 “Core”, February 22, 2001-
Bluetooth SIG
2. *Specification of the Bluetooth System* - version 1.1, Volume 2 “Profiles”, February 22, 2001 -
Bluetooth SIG
3. *Bluetooth Test Specification - RF A:2, 20.B.153/0.9*, March 24, 2000 - *Bluetooth* SIG
4. *Bluetooth Performance in Densely Packed Environments*, *Bluetooth Developers Conference*, 5-7 December 2000, San Jose, CA.
5. *Bluetooth RF Measurement Fundamentals*, Agilent Application Note # AN 1333-1 (lit. no. 5988-3760EN).
6. *Bluetooth RF Testing—The Right Test for the Radio Design*, Agilent article, May 2000
7. *Agilent Solutions for Bluetooth Wireless Technology*, brochure (lit. no. 5980-3032EN)

References 4, 5, 6, and 7 are accessible via the Agilent website: www.agilent.com/find/bluetooth

www.agilent.com

www.agilent.com/find/bluetooth

Agilent Technologies' Test and Measurement Support, Services, and Assistance

Agilent Technologies aims to maximize the value you receive, while minimizing your risk and problems. We strive to ensure that you get the test and measurement capabilities you paid for and obtain the support you need. Our extensive support resources and services can help you choose the right Agilent products for your applications and apply them successfully. Every instrument and system we sell has a global warranty. Support is available for at least five years beyond the production life of the product. Two concepts underlie Agilent's overall support policy: "Our Promise" and "Your Advantage."

Our Promise

Our Promise means your Agilent test and measurement equipment will meet its advertised performance and functionality. When you are choosing new equipment, we will help you with product information, including realistic performance specifications and practical recommendations from experienced test engineers. When you use Agilent equipment, we can verify that it works properly, help with product operation, and provide basic measurement assistance for the use of specified capabilities, at no extra cost upon request. Many self-help tools are available.

Your Advantage

Your Advantage means that Agilent offers a wide range of additional expert test and measurement services, which you can purchase according to your unique technical and business needs. Solve problems efficiently and gain a competitive edge by contracting with us for calibration, extra-cost upgrades, out-of-warranty repairs, and on-site education and training, as well as design, system integration, project management, and other professional engineering services. Experienced Agilent engineers and technicians worldwide can help you maximize your productivity, optimize the return on investment of your Agilent instruments and systems, and obtain dependable measurement accuracy for the life of those products.

By internet, phone, or fax, get assistance with all your test & measurement needs

Online assistance:
www.agilent.com/find/assist

**Phone or Fax
United States:**
(tel) 1 800 452 4844

Canada:
(tel) 1 877 894 4414
(fax) (905) 282-6495

China:
(tel) 800 810 0189
(fax) 1 0800 650 0121

Europe:
(tel) (31 20) 547 2323
(fax) (31 20) 547 2390

Japan:
(tel) (81) 426 56 7832
(fax) (81) 426 56 7840

Korea:
(tel) (82 2) 2004 5004
(fax) (82 2) 2004 5115

Latin America:
(tel) (305) 269 7500
(fax) (305) 269 7599

Taiwan:
(tel) 080 004 7866
(fax) (886 2) 2545 6723

Other Asia Pacific Countries:
(tel) (65) 375 8100
(fax) (65) 836 0252
Email: tm_asia@agilent.com

Bluetooth and the Bluetooth logos are trademarks owned by Bluetooth SIG, Inc., U.S.A. and licensed to Agilent Technologies, Inc.

Product specifications and descriptions in this document subject to change without notice.

© Agilent Technologies, Inc. 2001
Printed in USA September 30, 2001
5988-2417EN



Agilent Technologies