

Agilent AN 1309

Pulsed Carrier Phase Noise Measurements

Application Note



Agilent E5500 phase noise measurement system



Agilent Technologies

Table of Contents

3	Chapter 1 Introduction
4	Chapter 2 Fundamentals of Pulsed Carriers Time Domain Representation Frequency Domain Representation
10	Chapter 3 How Pulse Modulation Affects the SSB Phase Noise of a CW Carrier Convolution of CW Carrier Spectra and Pulsed Waveform Spectra Noise Aliasing With Pulse Modulation Mathematical Equation for a Pulsed RF Carrier Decrease in Carrier Power Decrease in Pulsed Carrier Spectral Power
16	Chapter 4 How Pulsing the Carrier Affects the Phase Detector Measurement Technique System Noise Floor Measurement Offset Range Mixer dc Offset Recommended Hardware Configurations LO AM Noise Suppression Phase Transients PRF Feedthrough Minimum Duty Cycle Summary

Chapter 1

Introduction

Advances in RF and microwave communication technology have extended system performance to levels previously unattainable. Design emphasis on sensitivity and selectivity have resulted in dramatic improvements in those areas. However, as factors previously limiting system performance have been overcome, new limitations arise and certain parameters take on increased importance. One of these parameters is the phase noise of signal sources used in pulsed RF and microwave systems.

In pulsed radar systems, for example, the phase noise of the receiver local oscillator sets the minimum signal level that must be returned from a target in order to be detectable. In this case, phase noise affects the selectivity of the radar receiver which in turn determines the effective range of the overall system.

Since the overall dynamic range of the radar system is influenced by the noise of the transmitted signal, it is not only important to know the

absolute noise of individual oscillators but to know the residual or additive noise of signal processing devices like power amplifiers and pulse modulators. Because the final signal in most radar systems is pulsed, making absolute phase noise measurements on the pulsed carrier is essential to determining the overall performance of the system.

This application note discusses basic fundamentals for making pulsed carrier phase noise measurements.

The assumption is made that the reader is familiar with the basic concepts of phase noise and CW phase noise measurement techniques.

Chapter 2 reviews the fundamentals of pulsed carriers in the frequency and time domains. The majority of terms used in succeeding chapters are defined throughout Chapter 2. Chapter 3 discusses how the single sideband phase noise of a CW carrier is affected by the pulse modulation process. Chapter 4 discusses the effects a pulsed RF carrier has on the performance of a phase detector based measurement.

Chapter 2

Fundamentals of Pulsed Carriers

The formation of a square wave from a fundamental sine wave and its odd harmonics is a good way to begin a discussion of pulsed carriers and their representation in the time and frequency domains.

You might recall having plotted a sine wave and its odd harmonics on a sheet of graph paper, then adding up all the instantaneous values. If there were enough harmonics plotted at their correct amplitudes and phases, the resultant waveform would begin to approach a square wave. The fundamental frequency determined the square wave rate, and the amplitudes of the harmonics varied inversely to their number.

A rectangular wave is merely an extension of this principle. In fact, to produce a rectangular wave, the phases must be such that all the harmonics go through a positive or negative maximum at the same time as the fundamental. Theoretically, to produce a perfectly rectangular wave, an infinite number of harmonics would be required. Actually,

the amplitudes of the higher order harmonics are relatively small, so reasonably shaped rectangular waves can be produced with a limited number of harmonics. By changing the relative amplitudes and phases of the harmonics, both odd and even, an infinite number of waveshapes can be plotted.

To create a train of pulses (i.e., a waveform whose amplitude alternates between zero and one) with a series of sine waves, a dc component must be added. Its value equals the amplitude of the negative loops of the rectangular wave with the sign reversed.

Consider a perfect rectangular pulse train as shown in Figure 1a, perfect in the sense that the rise time is zero and there is no overshoot or other aberrations. This pulse is shown in the time domain and if we wish to examine it in the frequency domain it must be broken down into its individual frequency components. Figure 1b superimposes the fundamental and its second harmonic plus a constant voltage to show how the pulse begins to take shape as more harmonics are plotted.

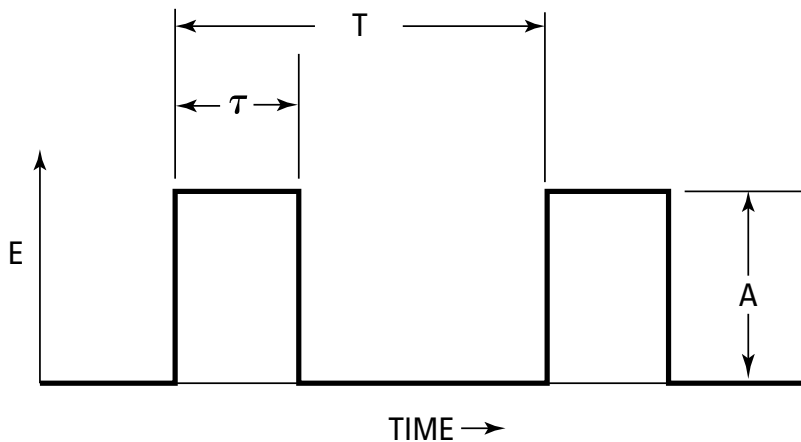

Figure 1a. Periodic rectangular pulse train

A spectrum analyzer would in effect “unplot” these waveforms and present the fundamental and each harmonic in the frequency domain.

A frequency domain plot of this waveform would be as shown in Figure 2. This is an amplitude versus frequency plot of the individual waves which would have to be added together to produce the waveform. Since all the waves are integer multiples of the fundamental (PRF), the spacing between lines is equal

to the PRF. The envelope of this plot follows a $\sin X/X$ function with the spectral line frequencies a $f_{LINE} = n X 1/T$, for $n = 1,2,3...∞$. Note that the nulls occur at integer multiples of the reciprocal of the pulse width.

Before proceeding on to a discussion of modulating a CW RF carrier with a pulsed waveform, let’s define the terms used to represent the characteristics of a pulsed waveform.

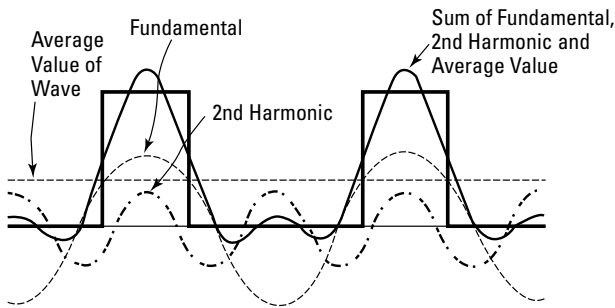

Figure 1b. Addition of a fundamental cosine wave and its harmonics to form rectangular pulses

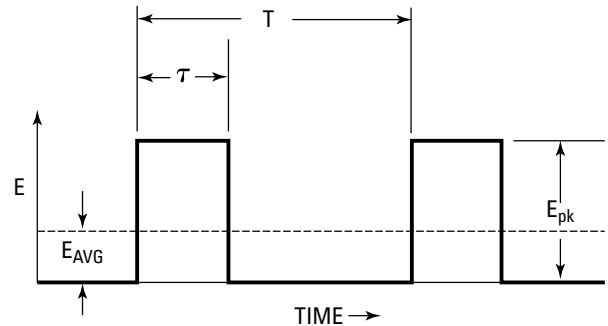

Figure 3. Basic characteristics of a pulsed waveform

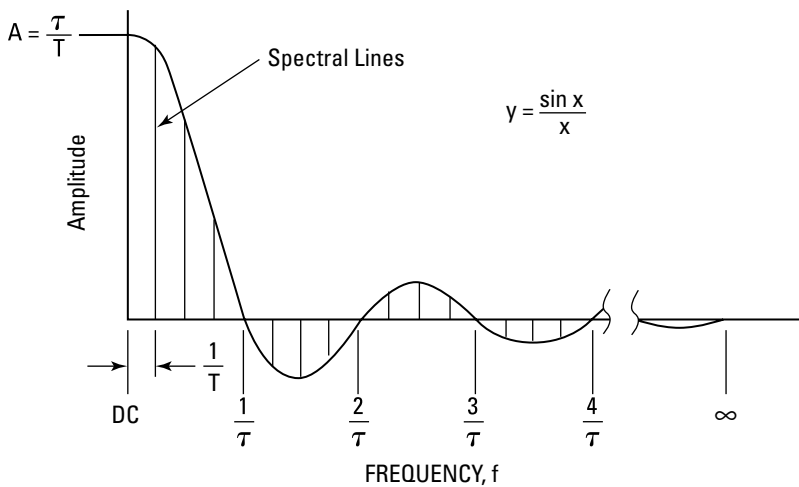

Figure 2. Spectrum of a perfectly rectangular pulse. Amplitudes and phases of an infinite number of harmonics are plotted resulting in a smooth envelope as shown.

Referring to Figure 3:

τ	Pulse width: Refers to the period of time during which the pulse is on, usually represented by the greek letter tau (τ).
T	Period: Refers to the time elapsed between the beginning of one pulse and the start of the next pulse (i.e., the time required to complete one cycle).
E_{PK}	Peak amplitude: Refers to the peak voltage level of each individual pulse.
E_{AVG}	Average amplitude: Refers to the average, or dc, value of the pulsed waveform. $E_{AVG} = E_{PK} \times \frac{\tau}{T}$
PRF	Pulse repetition frequency: Refers to the frequency at which the pulses are repeated, the number of pulses per second. $PRF = \frac{1}{T}$
Duty Cycle	Refers to the ratio of the pulse width to the pulse period. It represents the fraction of the time the pulse is on during one complete cycle. $\text{Duty Cycle} = \frac{\tau}{T}$

With this background we can now apply the pulsed waveform as amplitude modulation to a continuous wave RF carrier. A pulsed carrier is typically a continuous wave carrier whose amplitude is modulated by a rectangular pulse train having a relative amplitude of one during each pulse and zero during the period between pulses. Pulsed carriers can also be generated by pulsing a frequency generating device, such as an oscillator, on and off. One of the fundamental differences between these two methods is that an amplitude modulated CW carrier is phase continuous from pulse to pulse, whereas the phase of a frequency generating device, which is pulsed on and off, is random. Most measurement systems, using the phase detector technique, can only measure the phase noise of phase continuous signals. The phase detector technique requires that the two input signals be at quadrature (i.e., 90 degrees out of phase). If quadrature is lost, the system will terminate the measurement. Quadrature cannot be maintained if the phase from pulse to pulse is random.

From single tone AM modulation theory we know that sidebands will be produced above and below the carrier frequency. The concept is the same for a rectangular pulse train, except that the rectangular pulse train is made up of many tones, which produce multiple sidebands commonly referred to as spectral lines in the frequency domain. In fact, there will be twice as many sidebands or spectral lines as there are harmonics contained in the modulating pulse.

Figure 4 shows the spectral plot resulting from amplitude modulating a CW carrier with a rectangular pulse train. The individual lines represent the modulation products (upper and lower sidebands) of the CW carrier and the rectangular pulse train (fundamental and harmonics of the PRF). The spectral lines will be spaced in frequency by the fundamental frequency of the PRF.

The spectral line frequencies can be expressed as:

$$F_L = F_C \pm (n \times \text{PRF})$$

where F_C = carrier frequency

PRF = pulse repetition frequency

$n = 0, 1, 2, 3, \dots$

The “mainlobe” in the center and the “sidelobes” are shown as groups of spectral lines extending above and below the baseline. For perfectly rectangular pulses and other functions whose derivatives are discontinuous at some point, the number of sidelobes is infinite.

The mainlobe contains the carrier frequency represented by the largest spectral line in the center. Amplitude of the spectral lines forming the lobes varies as a function of frequency according to the expression

$$\frac{\sin \omega \frac{\tau}{2}}{\omega \frac{\tau}{2}}$$

for a perfectly rectangular pulse.

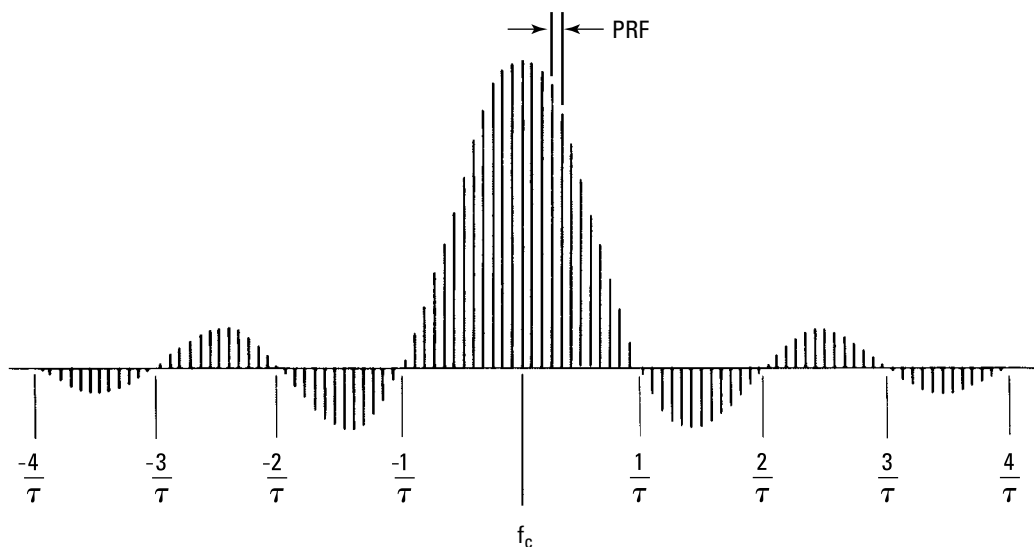

Figure 4. Resultant spectrum of a carrier amplitude modulated with a rectangular pulse

For a given carrier frequency, the points where these lines go through zero amplitude are determined by the modulating pulse width only. As pulse width becomes shorter, minima of the envelope become further removed in frequency from the carrier, and the lobes become wider. The sidelobe widths in frequency are related to the modulating pulse width by the expression $f = 1/\tau$. Since the mainlobe contains the origin of the spectrum (the carrier frequency), the upper and lower sidebands extending from this point form a main lobe $2/\tau$ wide. Remember, however, that the total number of sidelobes remains constant so long as the pulse quality, or shape, is unchanged and only its repetition rate is varied. Figure 5 compares the

spectral plots for two pulse widths, each at two repetition rates with carrier frequency held constant.

Notice in the drawings how the spectral lines extend below the baseline as well as above. This corresponds to the harmonics in the modulating pulse, having a phase relationship of 180 degrees with respect to the fundamentals of the modulating waveform. If these pulses were viewed using a spectrum analyzer, since a spectrum analyzer can only detect amplitudes and not phase, it would invert the negative-going lines and display all amplitudes above the baseline.

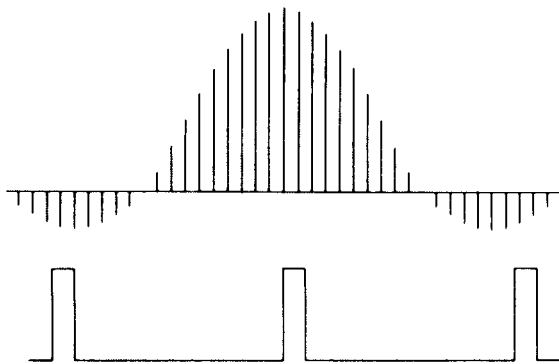

Figure 5a. Narrow pulse width causes wide spectrum lobes; high PRF results in low spectral line density.

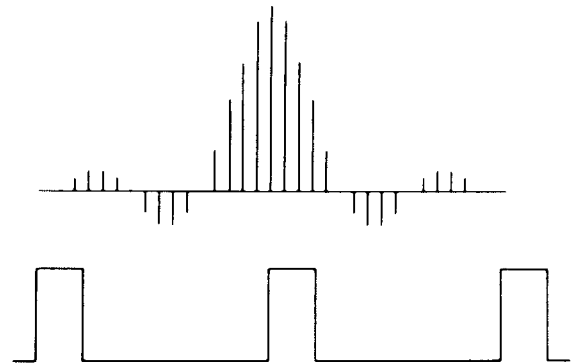

Figure 5b. Wider pulse than in Figure 5a causes narrower lobes, but line density remains constant since PRF is unchanged.

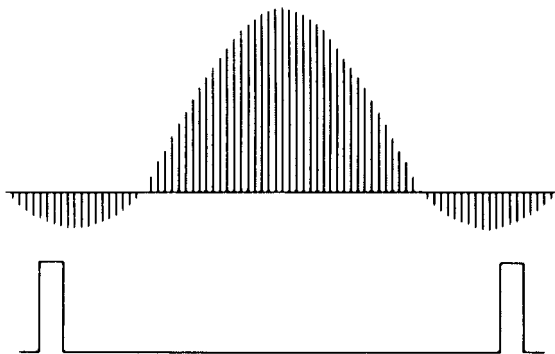

Figure 5c. PRF lower than in Figure 5a results in higher spectral density. Lobe width is the same as Figure 5a since pulse widths are identical.

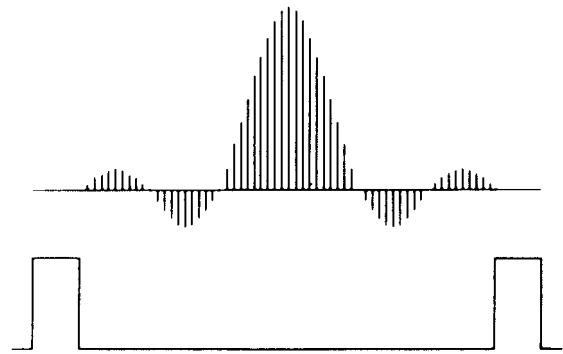

Figure 5d. Spectral density and PRF is unchanged from Figure 5c but lobe widths are reduced by wider pulse.

Before proceeding to a discussion of how the single sideband phase noise of a CW carrier is affected by the pulse modulation process, let's define the terms used to represent the characteristics of a pulsed carrier.

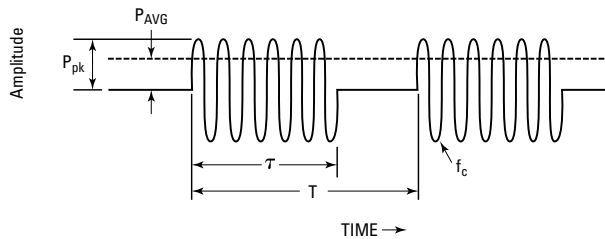

Figure 6. Basic characteristics of a pulsed carrier

Referring to Figure 6:

f_c Carrier frequency: Refers to the frequency of the unmodulated CW signal contained within the pulse envelope.

τ Pulse width: Refers to the duration of the pulses. It is usually represented by the lower case greek letter tau (τ).

T Pulse period: Refers to the time elapsed between the beginning of one pulse and the start of the next pulse.

PRF Pulse repetition frequency: Refers to the frequency at which the pulses are transmitted the number of pulses per second.

$$PRF = \frac{1}{T}$$

Duty cycle Refers to the ratio of the pulse width (τ) to the pulse period (T). It represents the fraction of time the pulse is on during one complete pulse period.

$$\text{Duty Cycle} = \frac{\tau}{T}$$

P_{PK} Peak power: Refers to the power of the individual pulses. If the power level is constant from the beginning to the end of each pulse, peak power is simply the peak power of the unmodulated CW signal.

P_{AVG} Average power: Refers to the peak power of the pulse averaged over the pulse period T . If the pulses are rectangular, the average power equals the peak power times the ratio of the pulse width τ to the pulse period T .

$$P_{AVG} = P_{PK} \times \frac{\tau}{T}$$

Chapter 3

How Pulse Modulation Affects the SSB Phase Noise of a CW Carrier

Having defined the basic characteristics of pulsed waveforms and pulsed carriers in Chapter 2, we will now focus our attention on how pulse modulation affects the distribution of the SSB phase noise of a CW carrier.

As defined in Chapter 2, a pulsed carrier is actually a continuous wave carrier whose amplitude is modulated by a rectangular pulse train having a relative amplitude of one during each pulse and zero. From modulation theory we know that any wave whose amplitude is modulated has two sidebands, an upper sideband and a lower sideband. Modulation theory also tells us that a portion of the total energy of the wave is contained in those sidebands. So one way of examining how the energy of a pulsed carrier is distributed is to look in the frequency domain at the sidebands produced when a CW carrier is pulse modulated.

Referring to Figure 7, amplitude modulation can be expressed in the time domain as the result of multiplying the CW carrier by a rectangular pulse train. Multiplication in the time domain is analogous to the convolution of the pulsed waveform spectra and the CW carrier spectra in the frequency domain, as shown in Figure 8.

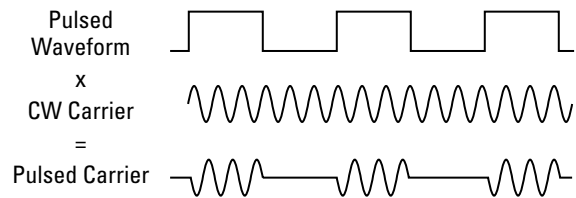

Figure 7. Multiplication of a CW carrier by a pulsed waveform results in a pulsed carrier.

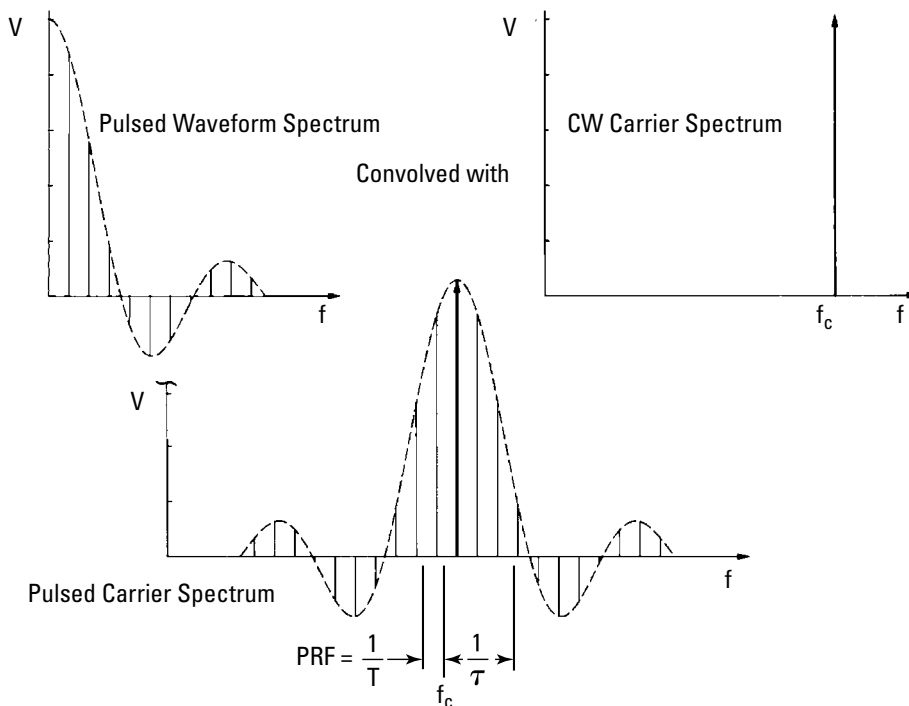

Figure 8. The spectrum of the product of two time functions is the convolution of their spectra.

When the CW carrier is amplitude modulated by the pulsed waveform, as illustrated in Figure 8, the sine wave represented by each spectral line in the pulsed waveform spectrum produces two sidebands, an upper sideband and a lower sideband. The fundamental produces sidebands at f_r (pulse repetition frequency) hertz above and below the CW carrier.

The second harmonic produces sidebands at $2f_r$ above and below the CW carrier. The zero frequency line produces an output at the carrier frequency. The convolution of the individual spectra produces all possible sums and differences of the CW carrier and all of the harmonic components contained in the modulating pulse.

If a single-sided spurious response is added to the CW carrier and pulse modulated, as illustrated in Figure 9, the spectrum of the pulsed waveform is convolved with both the CW carrier and the single-sided spur. The resultant spectrum is the sum of the individual spectra.

Figure 9 shows the spectrum which results from the convolution of the CW carrier with single-sided spur spectra and the pulsed waveform spectra. This example demonstrates two very important characteristics of the pulse modulation process:

- 1) The modulation process “aliased” a spur onto each of the PRF lines in the resultant pulsed carrier spectrum. The aliased spur is a sum or difference product of the spur and the pulsed wave-form spectra weighted by the $\sin X/X$ function.

- 2) No matter how great the offset between the CW carrier and the spur, an alias of the spur will appear within an offset of $\pm PRF/2$ of the central line.

If the single-sided spur were replaced with a double-sided spur and the pulse modulation process repeated, the double-sided spur would be aliased onto each of the PRF lines in the resultant pulsed carrier spectrum.

In the frequency domain a signal is no longer a discrete spectral line but spreads out over frequencies above and below the nominal signal frequency in the form of modulation sidebands due to random phase fluctuations. This is the “phase noise” of the signal. At any given offset from the carrier, the phase noise can be represented as a pair of discrete sidebands.

If the spur in Figure 9 is replaced with the phase noise of the CW carrier and the process repeated, as in Figure 10, the modulation process will alias the noise of the CW carrier onto each of the PRF lines in the pulsed carrier spectrum. As discussed in the case of the single-sided spur, the modulation process has two very significant effects on the composite signal:

- 1) The modulation process “aliased” the noise of the CW carrier onto each of the PRF lines in the pulsed carrier spectrum. The effect of this is that the composite noise at the central line has been increased by the sum of the aliased noise on each of the PRF lines weighted by the $\sin X/X$ function.

2) Phase noise information on the CW carrier at off sets above PRF/2 has been aliased to within $\pm PRF/2$ of the central line in the resultant pulsed carrier spectrum.

The effect of this, from a phase noise measurement perspective, is that after detection there is no new phase noise information above offsets of PRF/2 Hertz.

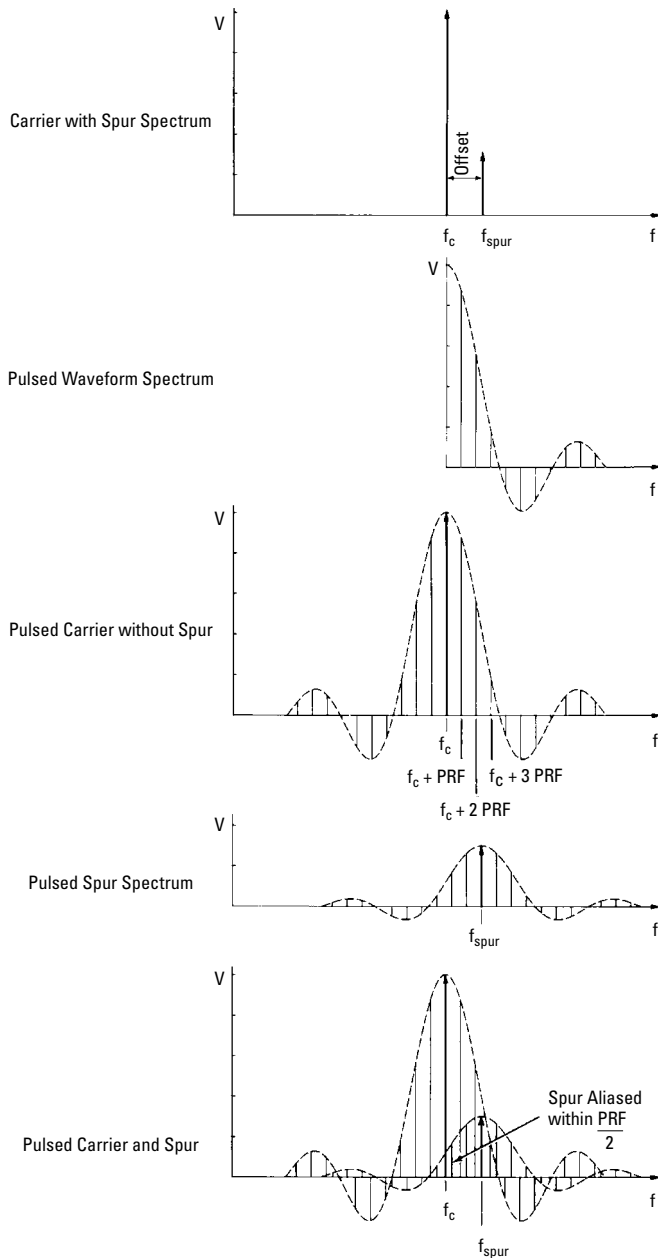

Figure 9. Convolution of a CW carrier with spur spectra and a pulsed waveform spectra

For fixed pulse width, the increase in noise at f_c will be inversely proportional to PRF (low PRF = high spectral line density large increase in noise at f_c ; high PRF = low spectral line density = small increase

in noise at f_c). For a fixed PR increasing the duty cycle relative to some nominal value, will result in decreased noise at f_c due to narrowing lobes.

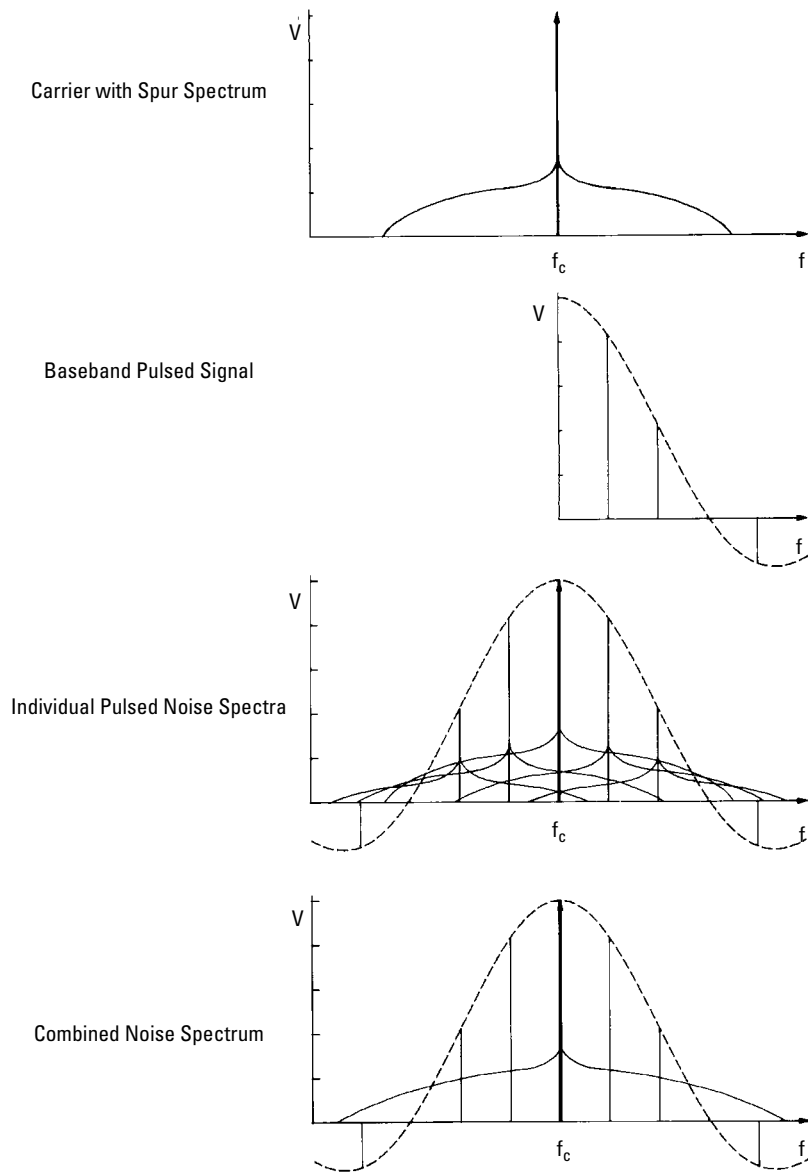

Figure 10. Noise aliasing with pulse modulation

As an upper limit the noise at f_c will increase by:

$$\approx 10 \log_{10} (\text{number of PRF lines to the first null})$$

This is a worse-case approximation and assumes that the noise contribution at each PRF line out to the first null is equal.

It should be noted that the shape of the CW carrier's phase noise energy distribution curve will affect the degree to which the noise is degraded at different offsets from the carrier. Typically, the slope of the close-in phase noise (0 to 100 Hz) will be very steep on the order of 20 to 40 dB per decade. Due to the $\sin X/X$ envelope, aliased noise at these offsets will be well below the CW noise and little degradation will be seen. At higher offsets, up to $1/2\text{PRF}$, the degradation will be more apparent especially if the CW noise curve has a pedestal (illustrated in Figure 10). Since a pedestal represents a relatively constant energy level over a range of offset frequencies the combined energy of the aliased noise will be greater than for a constantly decreasing slope. As previously discussed, above $1/2\text{PRF}$ the noise is simply repeated each PRF line.

Before proceeding to a review of the measurement technique used to make pulsed carrier phase noise measurements, one important question remains to be answered. All of the spectral plots shown so far have been of amplitude versus frequency. But nothing has been said about how this amplitude relates to the amplitude of the unmodulated carrier in the time domain.

We can clear up this discrepancy by developing a mathematical equation for a pulsed RF carrier and then examining the coefficients of the amplitude terms. Recall from Figure 7 that in the time domain, amplitude modulation can be expressed as the result of multiplying the CW carrier by the pulsed waveform. It follows that the mathematical equation for a pulsed RF carrier can be derived by multiplying the equations for the CW carrier and the pulsed waveform as follows:

$$\text{Unmodulated carrier: } f_1(t) = A \cos \omega_c t$$

$$\text{Pulsed Waveform: } f_2(t) = \frac{\tau}{T} \left[1 + 2 \sum_{n=1}^{\infty} \frac{\sin n \omega_0 \frac{\tau}{2}}{n \omega_0 \frac{\tau}{2}} \cos n \omega_0 t \right]$$

$$\text{Pulsed Modulated Carrier: } f_3(t) = f_1(t) \times f_2(t)$$

$$f_3(t) = A \frac{\tau}{T} \cos \omega_c t + A \frac{\tau}{T} \sum_{n=1}^{\infty} \frac{\sin n \omega_0 \frac{\tau}{2}}{n \omega_0 \frac{\tau}{2}} [\cos (\omega_{0+n} \omega_0) t + \cos (\omega_c - n \omega_0) t]$$

Examination of the amplitude term shows that after being pulsed modulated, the amplitude of the unmodulated carrier (A) is reduced by the ratio of τ to T.

In equation $f_3(t)$ the peak amplitude of the unmodulated carrier, A , is expressed as a voltage. The decrease in power of the modulated carrier (which appears as the central line in the pulsed carrier spectrum) relative to the power of the unmodulated CW carrier can be expressed in dB as follows (recall that power is proportional to voltage squared):

$$\begin{aligned}
 \text{Decrease in carrier power in dB} &= 10 \text{ Log}_{10} \left(\frac{E_2}{E_1} \right)^2 && E_2 = P_{PK} \text{ amplitude of central line in pulsed carrier spectrum} \\
 &= 10 \text{ Log}_{10} \left(\frac{A \frac{\tau}{T}}{A} \right)^2 && E_1 = P_{PK} \text{ amplitude of unmodulated carrier} \\
 &= 20 \text{ Log}_{10} \left(\frac{\tau}{T} \right)
 \end{aligned}$$

The average power of the pulsed carrier will also be affected by the duty cycle, as was discussed in Figure 6. The reduction in the average power of the pulsed carrier relative to the peak power of the unmodulated carrier can be expressed in dB as follows:

$$\begin{aligned}
 \text{Decrease in pulsed carrier power in dB} &= 10 \text{ Log}_{10} \left(\frac{P_{AVG}}{P_{PK}} \right) && P_{AVG} = \text{Average power of the pulsed carrier} \\
 &= 10 \text{ Log}_{10} \left(\frac{P_{AVG} \frac{\tau}{T}}{P_{PK}} \right) && P_{PK} = \text{Peak power of unmodulated carrier} \\
 &= 10 \text{ Log}_{10} \left(\frac{\tau}{T} \right)
 \end{aligned}$$

This apparent contradiction—carrier power drops by $20 \log(\tau/T)$ but spectral power drops by $10 \log_{10}(\tau/T)$ —is most easily explained as follows: pulsing a CW carrier results in its power being distributed over a number of spectral components (carrier and sidebands) and each of these spectral components then contains some fraction of the total power.

Chapter 4

How Pulsing the Carrier Affects the Phase Detector Measurement Technique

Having reviewed the basics of pulsed carriers and having discussed how pulsing a CW carrier affects its SSB phase noise, we will now turn our attention to the effects a pulsed RF carrier has on a phase detector based phase noise measurement system. The phase detector method is the recommended measurement mode for making both residual and absolute noise measurements on pulsed carriers.

It is assumed that the reader understands the principles and operation of the phase detector method of measuring SSB phase noise as well as the definition of residual and absolute measurements. Let's quickly review this method to establish a basis for understanding the problems which are encountered when applying this method to the measurement of pulsed carriers.

Figure 11 shows the basic block diagram of the phase detector method of measuring SSB phase noise. The phase detector (typically a double balanced mixer) is used to convert phase fluctuations to voltage fluctuations which are then displayed on a spectrum analyzer.

The use of mixers as phase detectors is based upon the fact that when two identical frequency constant amplitude signals are input to a mixer, a dc output which is proportional to the phase difference between the two signals is generated. The output at the IF port contains the sum and difference of the frequencies input to the LO and RF ports. If the RF and LO signals have identical frequencies their difference is 0 Hz or dc and will vary, as the cosine, of the phase difference between the LO and RF signals.

Their sum, which is twice the input frequency, can be selectively filtered off (if not already beyond the frequency response of the IF port) by a LPF following the mixer. By maintaining a 90-degree phase difference between the RF and LO ports the mixer operates in its most linear region ($\Delta V_{IF} \propto \Delta \theta_{LO-RF}$ with the constant of proportionality being the phase detector constant, K_{ϕ} , in volts/radian). The low noise amplifier (LNA) following the LPF amplifies the baseband signal above the noise of the spectrum analyzer. How the DUT is connected to the basic configuration determines whether the measurement will be an absolute or a residual measurement.

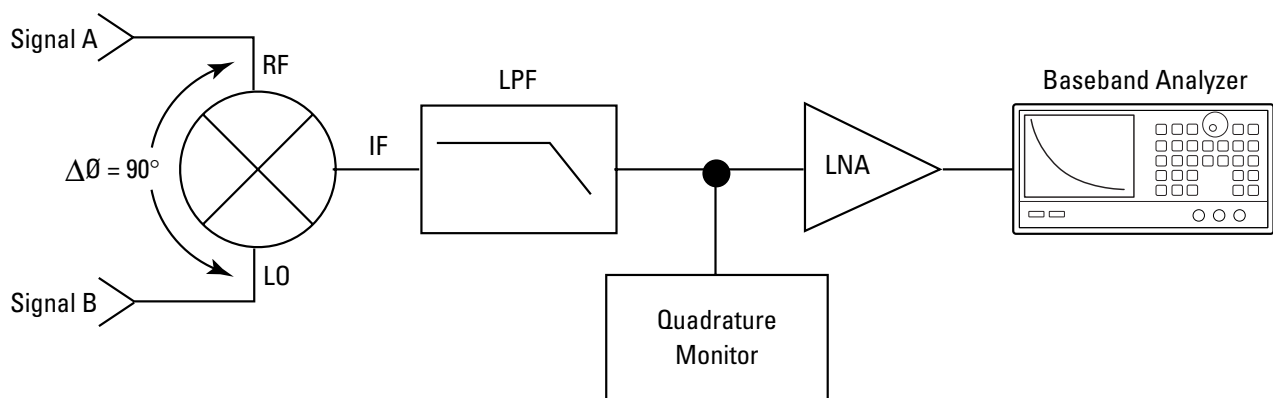

Figure 11. Block diagram of the phase detector method of measuring SSB phase noise

The discussions in this chapter will focus on the specific areas where the system's response to a pulsed signal is different than its response to a CW signal. Since the effects of pulsing the carrier are the same for either measurement the discussions will focus on these effects as they relate to the basic block diagram and not to a particular measurement configuration. The basic block diagram in Figure 11 will be referenced throughout this chapter when explaining the differences in response and their effect on system performance. Where possible, methods for dealing with these effects will be presented. This chapter will serve as a reference for subsequent chapters to explain the differences in measurement techniques which must be applied to pulsed signals as compared to CW signals. The recommended hardware configurations for making absolute or residual measurements on pulsed carriers will be presented in Chapter 5.

The items of concern in a pulsed carrier phase noise measurement are: system noise floor, measurement offset range, mixer dc offset, AM noise suppression, phase transients, PRF feedthrough, and minimum duty cycle.

System Noise Floor

A primary consideration when making any phase noise measurement is the system noise floor. The system noise floor represents the lowest level of noise which the system is capable of measuring for a given measurement configuration. When using the phase detector technique as shown in Figure 11

the system noise floor is set by the noise floor of the mixer, the noise floor of the LNA, and the phase detector constant. The LNA following the LPF amplifies the baseband signal above the noise floor of the spectrum analyzer thereby removing the spectrum analyzer as a limiting factor. The noise floor of the LNA and the phase detector are fixed by design, but the phase detector constant can vary from measurement configuration to measurement configuration. The phase detector constant specifies the sensitivity of the phase detector in converting phase fluctuations to voltage fluctuations.

The magnitude of the phase detector constant is a function of the maximum output voltage level of the phase detector. The greater the maximum output voltage level is, the more sensitive the phase detector becomes. The maximum output voltage level of the phase detector is a function of input drive level. It follows then, that anything which affects the input drive level to the phase detector also affects the phase detector constant. If the assumption is made that the signal at the LO input is strong enough to completely turn on the diodes, the maximum output voltage of the phase detector then becomes directly proportional to the RF input drive level. The RF drive level to the phase detector is set by the magnitude of the unmodulated carrier. Under pulsed conditions the amplitude (voltage) of the unmodulated carrier is reduced by $20 \log_{10}$ (duty cycle). This in turn decreases the maximum output voltage which decreases the sensitivity of the phase detector. As the sensitivity of the phase detector decreases, the smallest increment of

phase change which it can detect gets progressively larger. Viewed from a system perspective the minimum level of phase noise detectable by the system has increased. In other words, the system noise floor has degraded under pulsed conditions. The magnitude of this degradation can be determined by examination of the phase detector output under CW and pulsed conditions.

For a CW signal the output of an ideal phase detector, as a function of time, would appear as shown in Figure 12. The voltage fluctuations, VIF represent the sum of the noise of the reference and DUT (absolute measurement), or the sum of the internal noise floor and the noise added by the two port device (residual measurement). It should be pointed out that the vertical scale is greatly exaggerated for purposes of illustration.

Pulsing the carrier has several adverse effects when using the phase detector technique to measure

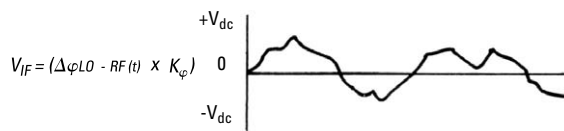

Figure 12. Phase detector output for a CW signal

phase noise. Phase noise measurements of pulsed carriers can be made, with some limitations, using the phase detector technique if these are accounted for.

For a pulsed carrier, the phase detector output becomes a sampled version of the CW phase noise with the sampling rate being the PRF. For an ideal phase detector, the only time there would be an output is when the pulse is on and there is a phase difference between the RF and LO ports. If there was no phase difference between the RF and LO ports, the output would be 0 Vdc with no evidence of pulse envelope or PRF feedthrough. Ideally, the LPF following the phase detector only has to filter the sum product of the RF and LO ports. The output of an ideal phase detector for a pulsed carrier would be as shown in Figure 13. Again, note the greatly exaggerated vertical scale used for purposes of illustration.

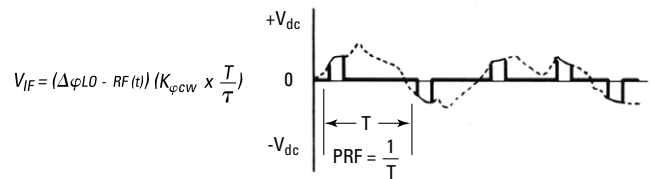

Figure 13. Phase detector output for a pulsed carrier

The effective sensitivity of the phase detector (the phase detector constant) is now scaled by the duty cycle of the pulsed carrier, just as in the case of the average or dc voltage of a rec angular waveform. For a pulsed measurement then:

$$K_{\Phi \text{PULSED}} = K_{\Phi \text{CW}} \times \frac{\tau}{T}$$

As previously discussed, this directly affects system sensitivity (i.e., system noise floor). Logarithmically, the degradation of the system noise floor is given by:

$$20 \text{ Log}_{10} (\text{duty cycle})$$

Measurement Offset Range

However, when measuring pulsed carriers, the valid measurement offset range is limited, based on sampling theory to one-half the PRF. A pulsed RF carrier is essentially a sampled version of the

unmodulated carrier. Sampling theory states that if a band-limited signal is amplitude modulated with a periodic pulse train, corresponding to extracting equally spaced time segments, it can be recovered exactly by low-pass filtering if the fundamental frequency of the modulating pulse train is greater than twice the highest frequency present in the band-limited signal. Sampling theory states that if the sampling frequency is twice the highest frequency in the band-limited sign there will be no overlap between the shifted replicas of the band-limited signal. The band-limited signal will be faithfully reproduced at integer multiples of the sampling frequency as shown in Figure 14 (c). However, if the band-limited signal is under-sampled there will be overlap of the shifted replicas as shown in Figure 14 (d). This effect, where the shifted replicas overlap, is referred to as aliasing. When aliasing occurs, the original frequency takes on the identity or alias of a lower frequency. Consequently, portions of the original signal are folded back onto itself when under sampling occurs.

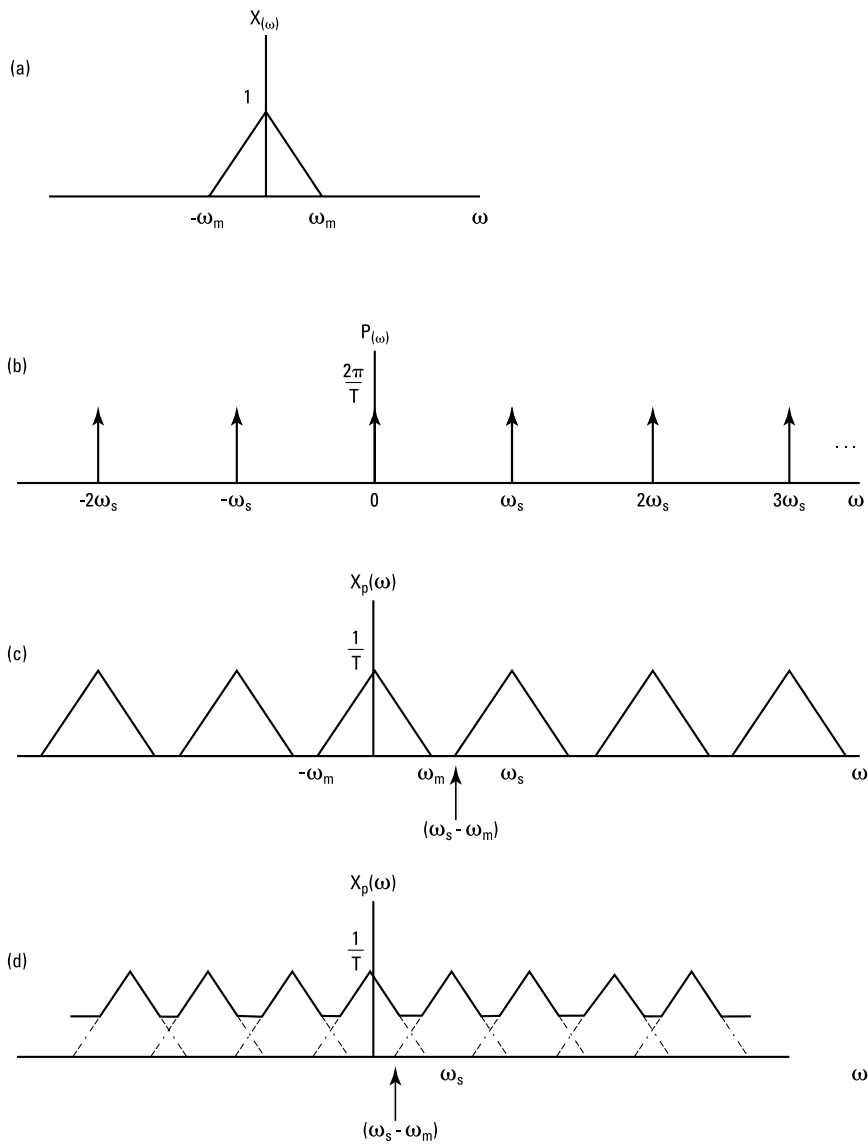

Figure 14. Frequency domain of sampling in the time domain

When sampling band-limited signals with a sampling frequency that is equal to exactly twice the highest frequency in the original signal, the shifted replicas will begin to overlap at the original signal's center frequency plus one-half the sampling

frequency. If under-sampling occurs, signal information at offsets above one-half the sampling frequency is folded or aliased to offsets below one-half the sampling frequency.

Since the phase noise of a CW carrier is not band-limited when it is amplitude modulated with a periodic pulse train, it is constantly being under-sampled and aliasing will always occur as was illustrated in Figures 9 and 10 in Chapter 3. This means that signal information at offsets above one-half the PRF will be aliased to offsets below one-half the PRF. Since all of the phase noise information of the CW carrier above offsets of one-half, the PRF will be aliased below PRF/2 of the central line in the pulsed waveform spectrum, and one only needs to measure out to the point where the overlap occurs (PRF/2). If the phase noise was directly measured around each PRF line in the pulsed spectrum, the same noise spectrum which is seen around the central line would repeat. While it is not necessary to limit the measurement offset range to one-half the PRF, it is necessary to recognize that the measured data is only useful to one-half the PRF.

Up to this point the discussions have been based on the characteristics of an “ideal” mixer used as a phase detector. Unfortunately, real mixers do not

exhibit such ideal characteristics. Attention will now be focused on these non-ideal characteristics and their effects on the measurement process.

Mixer dc Offset

Theoretically, when signals having identical frequencies are applied to the RF and LO ports of a mixer, the dc voltage at the IF port should be 0 Vdc when the phase difference between the RF and LO ports is 90 degrees. In practice, real mixers exhibit a dc offset at the quadrature point. The dc offset is the deviation from 0 Vdc that is seen at the mixer output when the RF and LO inputs are in quadrature. This dc offset is of concern because the measurement path through many systems are dc coupled and a large amount of dc offset can overload the LNA, forcing it to be removed from the measurement path. Removing the LNA degrades the system noise floor by 20 to 50 dB. When making CW measurements, the phase difference between the signals at the LO and RF ports, $\Delta\theta_{LO-RF}$, can be adjusted off quadrature to cancel the dc offset of the mixer, as shown in Figure 15.

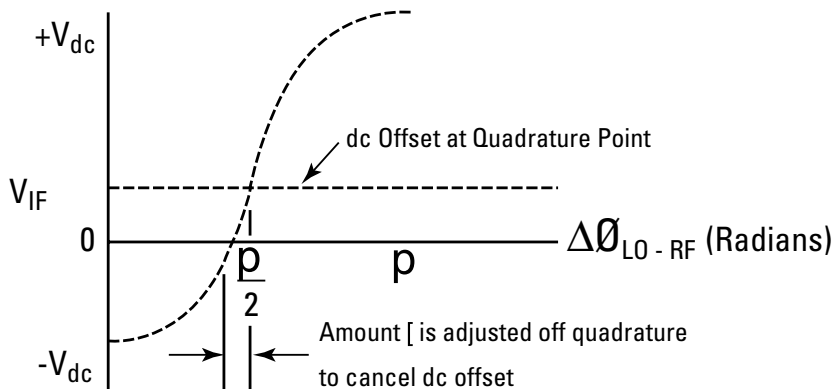

Figure 15. Cancelling dc offset by adjusting $\Delta\theta_{LO-RF}$ off quadrature

However, setting quadrature is not as straightforward when measuring pulsed carriers. When setting up a pulsed measurement, one would normally connect the pulsed DUT to the RF input of the phase detector and the reference signal to the LO input. Under these conditions the RF path is pulsed and the LO path is CW. During the pulse off interval, power is only applied to the LO port which produces a dc offset at the IF port. Adjusting the phase a few degrees off quadrature does not directly cancel this dc offset. The phase must be adjusted off quadrature by an amount necessary to produce an average dc value of 0 Vdc, as shown in Figure 16.

However, there are some negative consequences associated with doing this. As seen in Figure 16, this method produces high PRF feedthrough. If the magnitude of the feedthrough is sufficient to overload the LNA, a LPF would be required. The amount of phase shift required to produce a waveform with an average value of 0 Vdc may move the

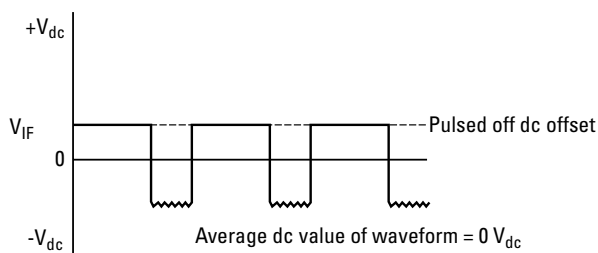

Figure 16. Compensating for dc offset by adjusting $\Delta\phi_{LO-RF}$ to produce an average dc value of 0 Vdc

point of measurement far from quadrature, thereby degrading the accuracy of the measurement. This becomes more pronounced as the duty cycle is reduced. As the pulse on time becomes a smaller and smaller percentage of the total pulse period, the amplitude of the pulse on time must be increased more and more to produce an average value of 0 Vdc. Since the amplitude of the pulse on time out of the phase detector is a function of the phase difference at its input ports ($\Delta\phi_{LO-RF}$), increasing the amplitude moves the measurement point farther and farther from the true quadrature point of 90 degrees. Additionally, moving the measurement point off quadrature increases the AM sensitivity of the phase detector which would further degrade the accuracy of the measurement.

An alternative approach which minimizes the negative consequences previously mentioned, is to adjust the phase for minimum deviation from dc offset during the pulse on period as shown in Figure 17.

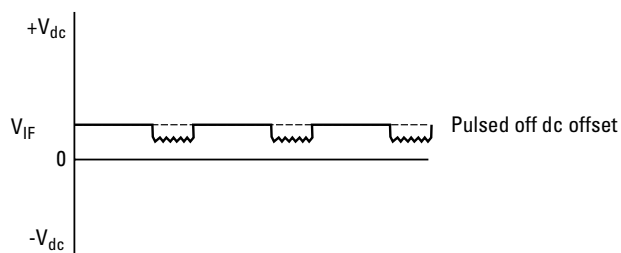

Figure 17. Adjusting phase for minimum deviation from dc offset during pulse on period

The advantages of this method are:

- PRF feedthrough is minimized
- LPF for PRF may not be necessary
- Point of measurement can be as close to quadrature as the CW case

However, since the dc offset has not been cancelled by averaging the waveforms dc value to 0 Vdc, the average dc value must pass through the LNA, possibly overloading it and forcing it to be removed from the measurement path. The negative consequence of removing the LNA, as previously discussed, is severe degradation of the system noise floor.

The recommended method for measuring the phase noise of pulsed carriers which eliminates the dc offset problem is to pulse both the LO and RF paths to the phase detector. This technique also minimizes AM noise problems (AM noise problems will

be discussed in a following section). By pulsing both paths to the phase detector an output is produced only during the pulse on interval. This effectively eliminates the dc offset caused by the LO signal being present during the pulse off interval. The advantages of this method are:

- Minimizes PRF feedthrough
- PRF filter may not be required
- Point of measurement as close to quadrature as CW case
- Minimizes AM noise contribution

The basic block diagram for making a pulsed residual measurement is shown in Figure 18. Figure 19 shows the basic block diagram for making a pulsed absolute measurement using this technique. Figure 20 shows the output of the phase detector, at the quadrature point, when pulsing both the RF and LO paths to the phase detector.

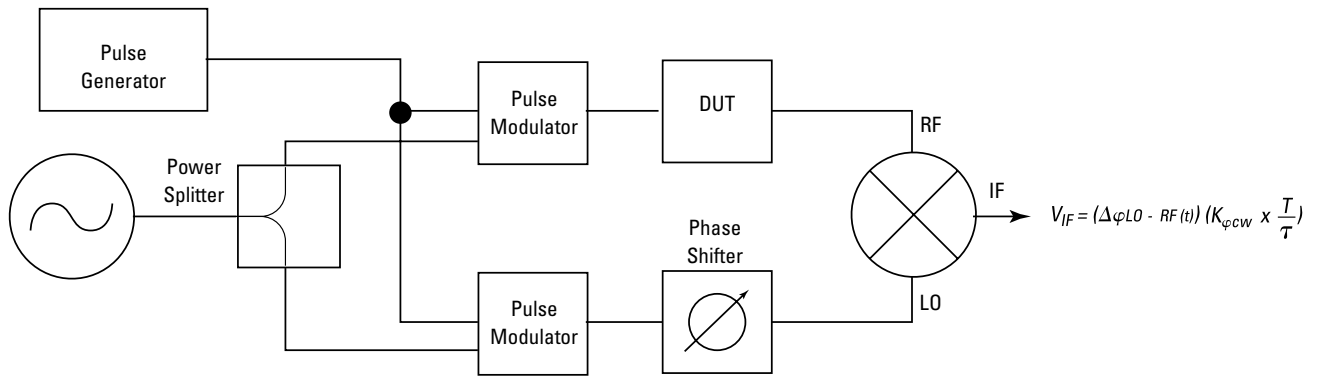

Figure 18. Recommended configuration for making pulsed residual noise measurement

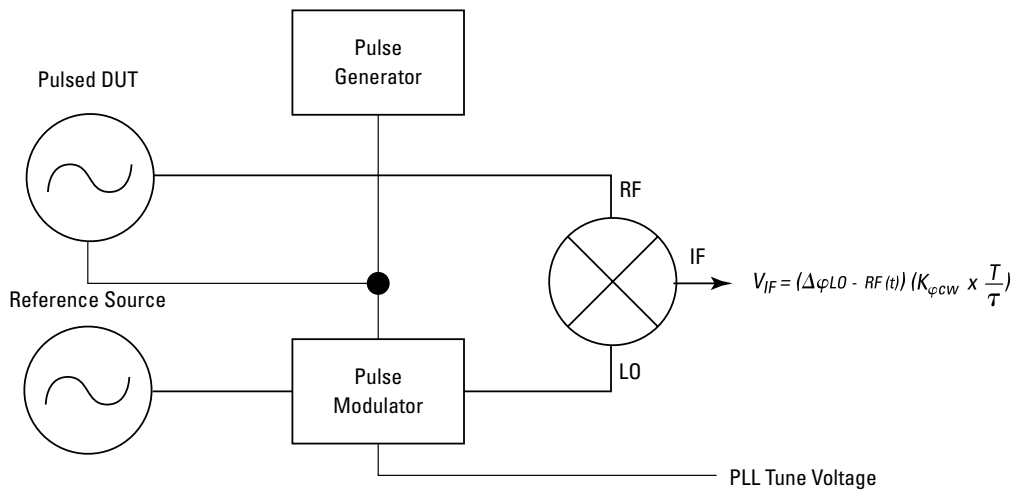

Figure 19. Recommended configuration for making pulsed absolute noise measurement

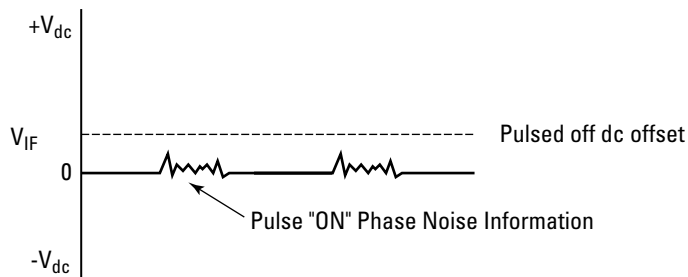

Figure 20. Phase detector output at quadrature when pulsing both inputs

LO AM Noise Suppression

Analogous to the single sideband phase noise definition, AM noise is defined as the noise power in one AM modulation sideband divided by the total signal power in units of dBc/Hz. AM noise plays an important role in phase noise measurements because it can affect the accuracy of the phase noise measurement.

One benefit of a double balanced mixer configuration is the suppression of AM noise associated with the local oscillator. AM noise components near the LO signal frequency will produce noise within the bandwidth of the IF port. Compared to single-ended mixers, converted noise will appear suppressed in a double-balanced mixer by 30 to 40 dB at lower UHF frequencies while at microwave frequencies values of 10 to 20 dB are common. LO AM noise suppression is also evidenced when a double balanced mixer is operated as a phase detector.

Typically, when measuring the noise of CW signals, the level of AM noise is well below the level of phase noise and does not degrade the accuracy of the phase noise measurement. However, this situation changes when attempting to measure the phase noise of a pulsed carrier.

As previously discussed, under pulsed conditions the phase detector constant is scaled by the duty cycle which reduces the level of phase noise seen on the output of the phase detector. When only the DUT path to the phase detector is pulsed, LO AM noise is present at the output of the phase detector

100% of the time while the DUT phase noise is only present during the pulse on time. Consequently the LO AM noise becomes a larger component of the total measured noise. If both paths to the phase detector are pulsed the LO AM noise returns to the same relative level as in the CW case.

Additionally, if only the DUT path is pulsed the LO AM noise component will begin to dominate at very low duty cycles. If both paths are pulsed the LO AM noise component will always be present in the same relative level as in the CW case. Therefore, pulsing both paths to the phase detector allows measurements to be made at lower duty cycles.

Phase Transients

As a consequence of the pulse modulation process, the instantaneous phase of the DUT output signal may undergo rapid fluctuations during turn-on and turn-off. These rapid fluctuations will appear as transients at the output of the phase detector as shown in Figure 21.

These phase transients can only be observed on a wideband oscilloscope connected to the AUX monitor port on the baseband test set. They cannot be evaluated with a spectrum analyzer on either the pulsed RF carrier or the AUX monitor port since a spectrum analyzer provides no information about the shape of the waveform in the time domain. These transients can have several adverse affects on the measurement process.

If the amplitude of the transient exceeds a saturation level at the output of the LNA, the LNA gain will be minimum and degrade the system noise floor by 20 to 30 dB. This indicates that the LNA is in saturation. LNA overload may be monitored by a peak detector at the output of the LNA. The overload trip point established for CW operation level is set to prevent saturation of the LNA, and is set at the output of the LNA. As shown in Figure 21, the amplitude of the leading or trailing phase transient may exceed the CW trip point only for a fraction of the pulse width. Under pulsed conditions it is acceptable to manually manage the LNA gain if no saturation occurs on that portion of the signal. In order to make this possible, the test set should give the operator the ability to manage the LNA gain while observing the phase detector output on a wideband oscilloscope connected to a monitor port on the baseband test set. If the portion of the waveform which contains the phase noise information shows any sign of saturation the LNA gain should be reduced. However, even though the phase transients themselves may show signs of saturation, as shown in Figure 22, the LNA gain can be maximized providing the remaining LNA criteria are satisfied.

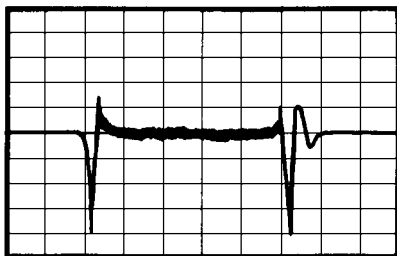

Figure 21. Phase transients at output of phase detector as observed on an oscilloscope connected to the AUX monitor port

Since the phase transients are coincident with the pulse, they will appear as PRF feedthrough which may necessitate the use of a PRF filter. If the magnitude of the transients cause the LNA to overload and be removed from the measurement path by the system, a PRF filter can be inserted before the LNA. A properly designed PRF filter will sufficiently reduce the magnitude of the phase transients so that the LNA can be left in the measurement path. If a PRF filter is required, an external phase detector must be used as discussed in the section “PRF Feedthrough.”

Finally, if the phase transients exceed 0.2 radians for more than 10% of the pulse width, as shown in Figure 23, the measurement accuracy is degraded. Under these conditions measurement accuracy can be determined manually by inserting a phase modulator into one path to the phase detector, introduce a phase modulation sideband and calibrate on sideband level.

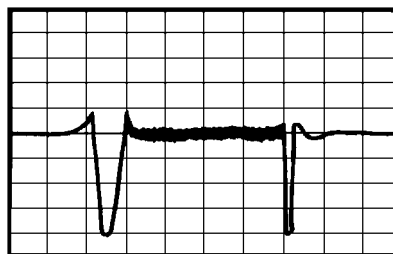

Figure 22. Phase transients with saturation as observed on an oscilloscope connected to AUX monitor port

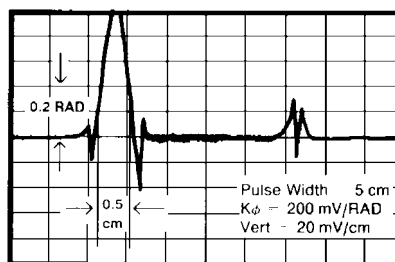

Figure 23. Phase transients exceeding 0.2 radians for more than 10% of pulse width as observed on an oscilloscope connected to AUX monitor port

PRF Feedthrough

Under pulsed conditions an ideal phase detector at the quadrature point would only produce an output voltage when the pulse is on and there is a phase difference between the LO and RF inputs. In the ideal case if there was no phase difference between the input ports the output would always be 0 Vdc. No pulse envelope or PRF feedthrough would be seen. In the ideal case, the LPF following the phase detector would only have to filter off the sum product of the RF and LO ports. However, in the practical case, PRF feedthrough will exist. Throughout this chapter we have discussed two of the mechanisms which contribute to PRF feedthrough phase transients, and moving from the quadrature point to compensate for mixer dc off-

set. Additionally, since the port to port isolation of the mixer is not infinite, some carrier feedthrough will exist as a result of the mixing process itself.

It is the magnitude of the PRF feedthrough which is of concern in a pulsed carrier phase noise measurement. Too much PRF feedthrough can overload the LNA and/or the baseband spectrum analyzer resulting in measurement inaccuracy and system noise floor degradation. Under these conditions (excessive PRF feedthrough) an additional PRF filter can be added to the measurement path to reduce the magnitude of the feedthrough, as shown in Figure 24.

The PRF filter should be designed to have the response characteristics shown in Figure 25.

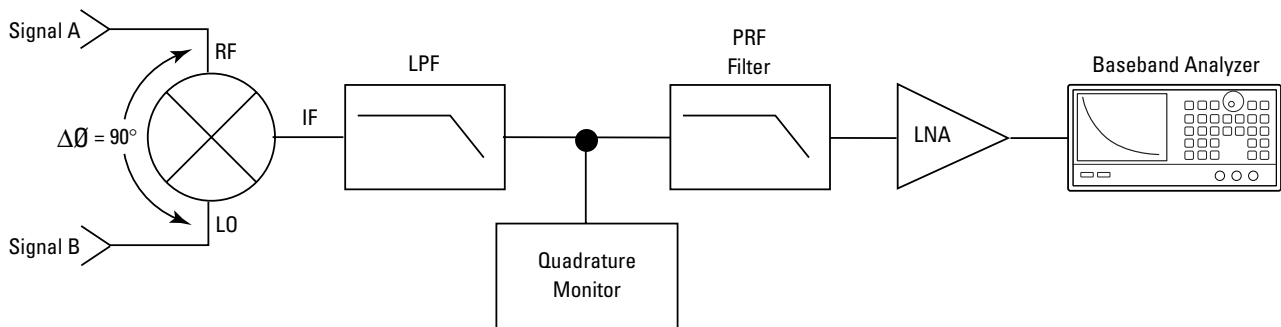
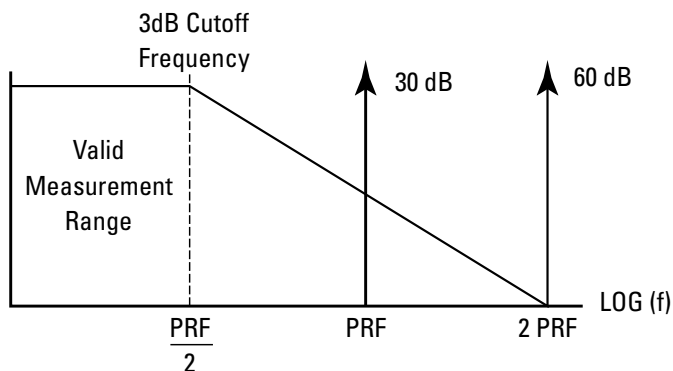

Figure 24. Proper location of PRF filter in measurement path



Phase noise measurements can be made out to $\frac{PRF}{2}$ Hz away from carriers.

Figure 25. PRF filter response characteristics

The absolute magnitude of the PRF feedthrough for a given measurement configuration cannot be empirically determined before the measurement is attempted. Consequently, the need for a PRF filter typically manifests itself during the measurement process. However, experience has shown that for many configurations measurements can be made successfully without a PRF. When a PRF filter is required an external phase detector must also be used since there is no direct access to the output

of the internal phase detectors in the baseband test set. Figures 26 and 27 show the recommended hardware configurations for making pulsed phase noise measurements when a PRF filter is required.

When PRF feedthrough is excessive and a PRF filter is necessary, the Watkins Johnson WJM9H can be used as an RF phase detector from 5 MHz to 1.6 GHz, and the NORSAL DBM 1-26 can be used as a microwave phase detector from 1.2 GHz to 18 GHz.

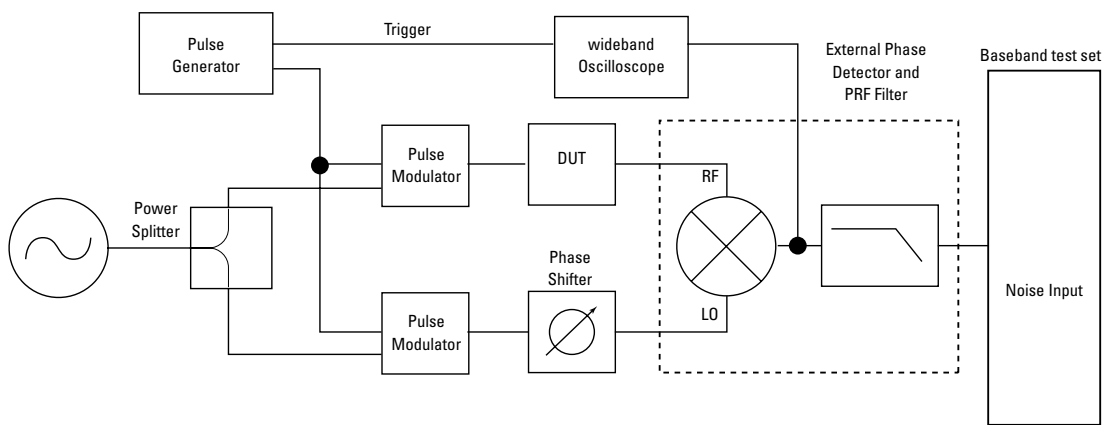

Figure 26. Recommended hardware configuration for pulsed residual measurements when a PRF filter is required

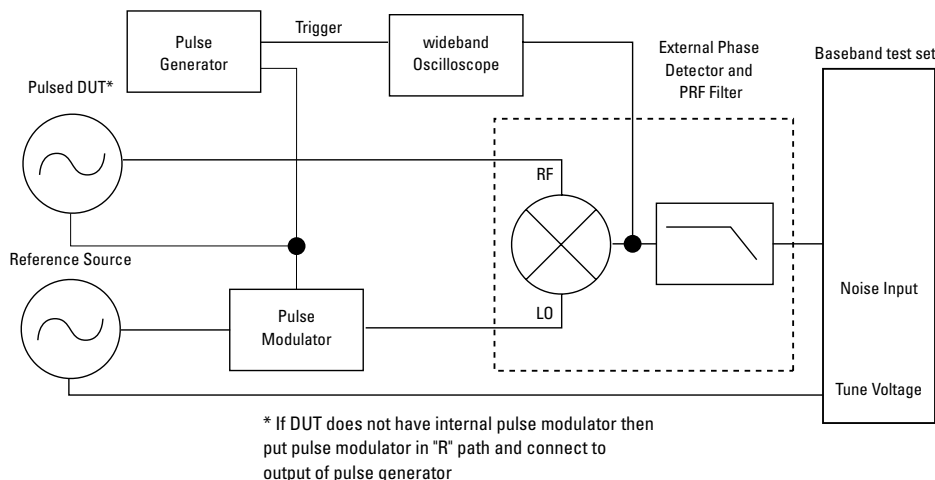

Figure 27. Recommended hardware configuration for pulsed absolute measurements when a PRF filter is required

Minimum Duty Cycle

One of the limitations of a phase noise measurement system when used to make pulsed carrier phase noise measurements, is the minimum duty cycle which the system will measure. Limitations in the measurement are different for absolute and residual measurements.

For the absolute case which uses a PLL to maintain quadrature, the criteria is driven by maintaining an acceptable average signal level for proper PLL. At duty cycles less than 5%, the amplifiers in the PLL generally do not have enough gain to provide the necessary signal level to keep the loop locked. Some systems may be able to keep the PLL locked at a duty cycle less than 5% and those measurements would be valid as long as the PLL remains locked.

For the residual case a minimum duty cycle of 1% or greater is usually necessary for acceptable measurements. The noise floor is determined by the duty cycle. The overall noise floor is degraded by a factor of:

$$20 \log_{10} (\text{duty cycle})$$

For example, a 1% duty cycle would degrade a system noise floor by 40 dB. It is possible to measure lower duty cycles when making residual measurements providing the system noise floor remains low enough to be useful.

Summary

The phase detector method is the recommended measurement mode for making residual and absolute single sideband phase noise measurements on pulsed carriers. This chapter has focused on the effects a pulsed carrier has on the phase detector method of phase noise measurement.

Measurement Offset Range: The measurement offset range is determined by the bandwidth of the baseband test set (amplifiers and filters within the test set) and the bandwidth of the baseband analyzer used to measure the baseband signal. The measured data offset range is only useful up to PRF/2.

Minimum Duty Cycle Range: The minimum duty cycle for absolute measurements is typically greater than 5%, and dependent on the PLL remaining locked. For residual measurements the duty cycle determines how much the noise floor is degraded.

Noise Floor: For a phase noise measurement system, the noise floor of the measurement would be the phase detector noise scaled by the duty cycle.



www.agilent.com/find/emailupdates

Get the latest information on the products and applications you select.



www.agilent.com/find/agilentdirect

Quickly choose and use your test equipment solutions with confidence.



www.agilent.com/find/open

Agilent Open simplifies the process of connecting and programming test systems to help engineers design, validate and manufacture electronic products. Agilent offers open connectivity for a broad range of system-ready instruments, open industry software, PC-standard I/O and global support, which are combined to more easily integrate test system development.

www.agilent.com

Agilent Technologies' Test and Measurement Support, Services, and Assistance

Agilent Technologies aims to maximize the value you receive, while minimizing your risk and problems. We strive to ensure that you get the test and measurement capabilities you paid for and obtain the support you need. Our extensive support resources and services can help you choose the right Agilent products for your applications and apply them successfully. Every instrument and system we sell has a global warranty. Two concepts underlie Agilent's overall support policy: "Our Promise" and "Your Advantage."

Our Promise

Our Promise means your Agilent test and measurement equipment will meet its advertised performance and functionality. When you are choosing new equipment, we will help you with product information, including realistic performance specifications and practical recommendations from experienced test engineers. When you receive your new Agilent equipment, we can help verify that it works properly and help with initial product operation.

Your Advantage

Your Advantage means that Agilent offers a wide range of additional expert test and measurement services, which you can purchase according to your unique technical and business needs. Solve problems efficiently and gain a competitive edge by contracting with us for calibration, extra-cost upgrades, out-of-warranty repairs, and onsite education and training, as well as design, system integration, project management, and other professional engineering services. Experienced Agilent engineers and technicians worldwide can help you maximize your productivity, optimize the return on investment of your Agilent instruments and systems, and obtain dependable measurement accuracy for the life of those products.

United States:

(tel) 800 829 4444

(fax) 800 829 4433

Canada:

(tel) 877 894 4414

(fax) 800 746 4866

China:

(tel) 800 810 0189

(fax) 800 820 2816

Europe:

(tel) 31 20 547 2111

Japan:

(tel) (81) 426 56 7832

(fax) (81) 426 56 7840

Korea:

(tel) (080) 769 0800

(fax) (080) 769 0900

Latin America:

(tel) (305) 269 7500

Taiwan:

(tel) 0800 047 866

(fax) 0800 286 331

Other Asia Pacific

Countries:

(tel) (65) 6375 8100

(fax) (65) 6755 0042

Email: tm_ap@agilent.com

Contacts revised: 09/26/05

For more information on Agilent Technologies' products, applications or services, please contact your local Agilent office. The complete list is available at:

www.agilent.com/find/contactus

Product specifications and descriptions in this document subject to change without notice.

© Agilent Technologies, Inc. 2006, 2000, 1998

Printed in USA, June 1, 2006

5968-2081E

