

3 Steps to Better Baseband, IF and RF Design with the HP 8751A

Application Note 1202-3

**HP 8751A
Network Analyzer
5 Hz to 500 MHz**

Summary: This note details how to improve product design and testing with the enhanced measurement capabilities of the HP 8751A.

Step 1

Start with Measurement Performance

Greater measurement accuracy results in increased design confidence and design success. The 1 mHz frequency resolution of the HP 8751A allows testing of even the most demanding narrow-band, high-Q, devices.

Measurement uncertainty is reduced because system performance characteristics are given not only for the HP 8751A network analyzer itself, but also together with the S-parameter test set, HP 87511A. Join this capability with calibration menu choices up to full 2-port, which effectively removes all 12 correctable system errors, and you get accurate and reliable results.

The Right Answers—the First Time

Traditional network analyzers often have frequency discrepancies depending on the sweep direction and sweep speed. The HP 8751A solves this problem with its digital pre-tuning technique which reduces frequency uncertainty.

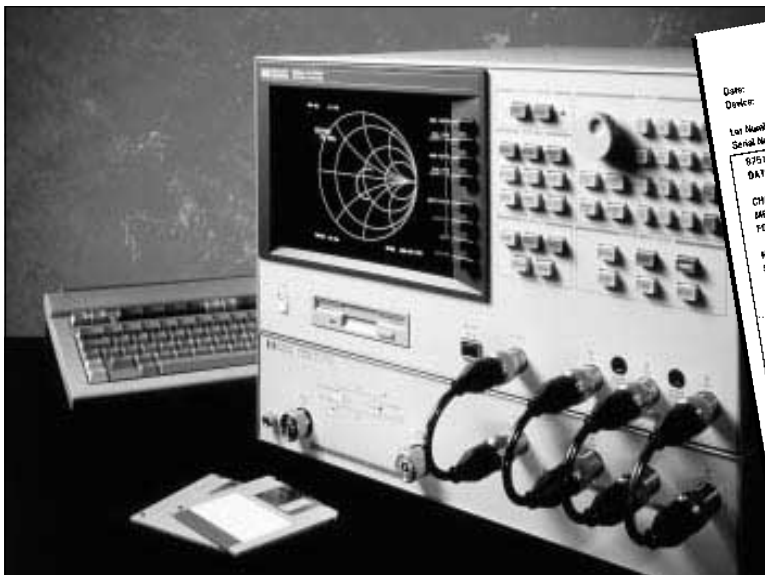

**Final Test Report
70 MHz IF Filter**

Date: 21 July 1991
Device: 70 MHz Inter low IF circuit assembly #3
Lot Number: 001-prototype
Serial Number: P-8751A-001 to 025
DATE: July 15 1991

8751A TESTS 00
DATE: July 15 1991

CHANNEL: 1
MEASURE TYPE: S21
FORMAT TYPE: LOG MAG & GROUP DELAY
NUMBER of POINTS: 15
SWEEP TIME: 51 ms
SWEEP TYPE: LHM FREQ
SOURCE POWER: 0 dBm

IF BANDWIDTH	Insertion Loss
60.000	-40.958 dB
60.500	-38.191 dB
61.000	-28.412 dB
61.500	-6.768 dB
62.000	-6.875 dB
62.500	-2.055 dB
63.000	-2.052 dB
63.500	-2.782 dB
64.000	-4.165 dB
64.500	-4.162 dB
65.000	-5.777 dB
65.500	-7.500 dB
66.000	-16.875 dB
66.500	-33.063 dB
67.000	-45.500 dB

Table 1. Typical insertion loss values for the 70 MHz IF filter.

Discussion: We suggest production yields to be better than 95% for the units shown, since we have identified the likely source of the high-loss (failing) units. They were the first 6 units lost.

200000
The initial design group delivered the final design and first prototype two weeks ahead of schedule. Significant time was saved in writing the production test software because the design group also delivered the required tests which were hardware-equipped into a disk.

Figure 1. The filter has greater than 20 dB rejection at $f_c \pm 100$ kHz.

Figure 2. Distribution of insertion loss values in the test run.

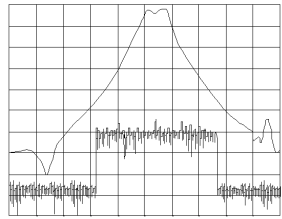
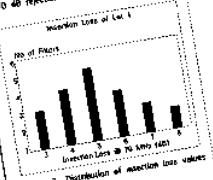
Reliable Results... Without Sacrificing Speed

With the HP 8751A you don't trade performance for speed. Resolution bandwidths, from 2 Hz to 4 kHz, allow you to tune and test in real-time. For example, a 201 point sweep updates as fast as 11 times per second. The 4-trace, color display puts more information at your disposal.

In addition to the pre-tuning technique and sweep update rates, the advanced list sweep function is also optimized to give you maximum performance in minimum time.

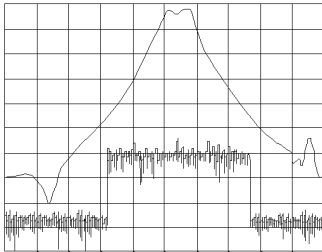

Figure 1.
The HP 8751A gives you fast list sweeps with 130 dB dynamic range.

Frequency, power, IF bandwidth and number of points (up to 801 points), can be set for each individual sweep segment. Figure 1, above, shows how power can be varied from segment to segment, (lower trace) to extend the dynamic range to 130 dB (upper trace). Complete control of these list sweeps is another tool you can use to test devices more thoroughly and in less time.

Step 2

Document Your Success

If your job is not complete until the paperwork is done, then you will really appreciate the HP 8751A. Documentation of results, an important task of every engineer, is quick and easy.

Save test set-ups and results to disk in either HP's LIF or MS-DOS® formats with the built-in disk drive. You can then link data to many popular software packages on workstations or personal computers.

Transfer test results from the HP 8751A directly into desktop published reports. For example, the graph in the test report shown below, in figure 2, was saved on the HP 8751A in HP's Graphics Language format (HP-GL), while the table of values was saved as an ASCII table and then exported to Lotus 1-2-3®. These files were then imported into Microsoft® Word to generate the report.

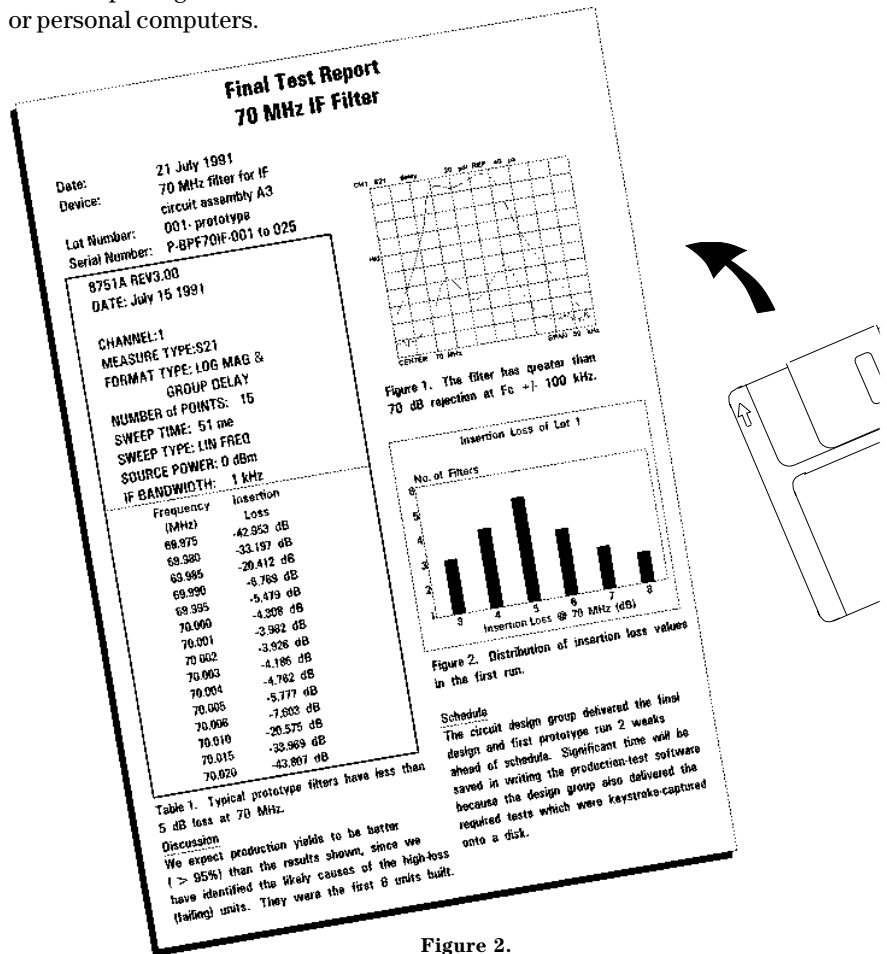

Figure 2.
Complete test reports like this are easy with the HP 8751A and your PC.

From Test... to Test Report... to Automatic Test Station

Print or plot hard-copies directly, complete with a timestamp, with the HP 8751A. Or, save to disk for later printing. Figure 3 shows a record of operating parameters.

OPERATING PARAMETER	Channel 1	Channel 2
NUMBER of POINTS	51	801
SWEEP TIME	2.703s	320.4 ms
SOURCE POWER	10 dBm	-5 dBm
PORT 1 ATTENTION	0 dB	0 dB
PORT 2 ATTENTION	0 dB	0 dB
INPUT R ATTENTION	20 dB	20 dB
INPUT A ATTENTION	20 dB	20 dB
INPUT B ATTENTION	0 dB	0 dB
IF BANDWIDTH	20 Hz	4 kHz
AVERAGING FACTOR	1	16
SMOOTHING APERTURE	1 % SPAN	5 % SPAN
	OFF	ON
GROUP DELAY APERTURE	4 % SPAN	1 % SPAN
CAL KIT	7 mm	7 mm
Z0	50	50
CAL TYPE	RESPONSE	S11 1-PORT

Figure 3.
Complete test records at the touch of a button.

If you use markers to measure key parameters, then you will benefit from the marker page display, which can be hardcopied directly to a printer. Figure 4 shows how this feature is used with a measurement of a filter.

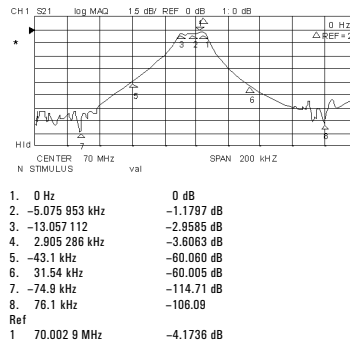

Figure 4.
Key parameters are easy to measure and document with the marker page function.

Step 3

Automate Easily with HP IBASIC

Get added flexibility and performance by putting a computer right inside the HP 8751A with Option 002, HP Instrument BASIC. Save time by automating repetitive or complex tasks such as device characterizations. Control other test equipment and peripherals via HP-IB and the digital I/O port.

Since HP IBASIC puts an instrument controller right inside the HP 8751A, configuring a stand-alone test station costs less and is simpler with Hewlett-Packard providing a one-vendor solution.

Reduce complex tests to onebutton measurements with HP IBASIC. Use the built-in keystroke recording function to sequence operation of the HP 8751A to fit your test procedure. Similar to the macro recording found in many PC

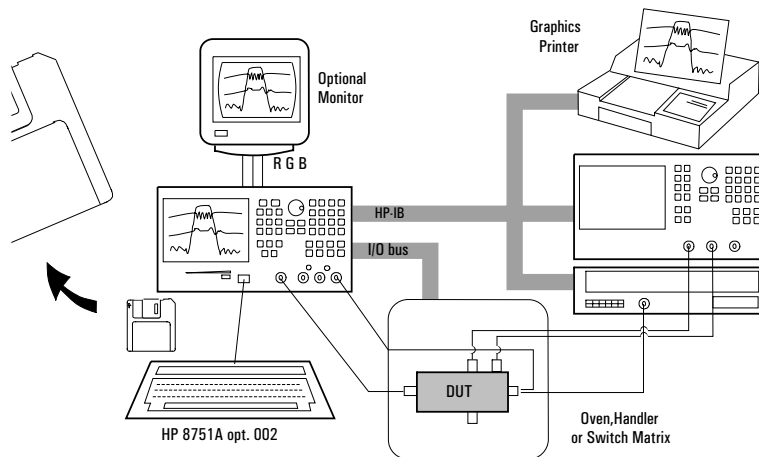

Figure 5.
HP 8751A with opt 002, HP IBASIC, controlling a test station.

programs, this function simplifies program generation by capturing manual keystrokes into an HP IBASIC program. Then access your new function from the front-panel softkey menu using any title or label you choose.

For example, you can completely automate complicated tests such as power sweep at different frequencies using several IF bandwidths over temperature or time. HP IBASIC adds extra capabilities that allow custom interfaces to be designed for each user, and ease the transition from design lab to manufacturing floor.

Programs developed with HP IBASIC can be used not only for initial development work in the lab but also can be given to the manufacturing engineer to form the basis of a production test program.

To further automate filter and resonator measurements, use the built-in Waveform Analysis commands of the HP 8751A. These commands, accessible via HP-IB or with HP IBASIC, return measured values of key parameters of filters and resonators by invoking a single command. Replace time-consuming manual marker manipulations with these Waveform Analysis commands.

For more information on the HP 8751A, including HP IBASIC, please see the referenced documents.

Also ask for:

HP 8751A Network Analyzer Brochure
(part number: 5952-2370)

HP 8751A Technical Data Sheet
(part number: 5952-2373)

HP Instrument Basic HP 8751A Option 002 Technical Data Sheet
(part number: 5091-2034E)

HP 8751A Ordering Guide
(part number: 5952-2372)

Designing Impedance Matching Networks with the HP 8751A Application Note 1202-1
(part number: 5091-1560E)

17 Fixtures, Test Sets and Accessories for the HP 8751A Application Brief AN 1202-2
(part number: 5091-1985E)

HP-IB is Hewlett-Packard's implementation of IEEE Standard 488-1978

Lotus and 1-2-3 are U.S. registered trademarks of Lotus Development Corporation

MS-DOS is a U.S. registered trademark of Microsoft Corporation

For more information about Hewlett-Packard test & measurement products, applications, services, and for accurate sales office listing, visit our web site, <http://www.hp.com/go/tmdir>. You can also contact one of the following centers and ask for a test and measurement sales representative.

United States:

Hewlett-Packard Company
Test and Measurement Call Center
P.O. Box 4026
Englewood, CO 80155-4026
1 800 452 4844

Canada:

Hewlett-Packard Canada Ltd.
5150 Spectrum Way
Mississauga, Ontario
L4W 5G1
(905) 206 4725

Europe:

Hewlett-Packard
European Marketing Centre
P.O. Box 999
1180 AZ Amstelveen
The Netherlands
(31 20) 547 9900

Japan:

Hewlett-Packard Japan Ltd.
Measurement Assistance Center
9-1, Takakura-Cho, Hachioji-Shi,
Tokyo 192-8510, Japan
Tel: (81) 426 56 7832
Fax: (81) 426 56 7840

Latin America:

Hewlett-Packard
Latin American Region Headquarters
5200 Blue Lagoon Drive
9th Floor
Miami, Florida 33126
U.S.A.
Tel: (305) 267-4245
(305) 267-4220
Fax: (305) 267-4288

Australia/New Zealand:

Hewlett-Packard Australia Ltd.
31-41 Joseph Street
Blackburn, Victoria 3130
Australia
Tel: 1 800 629 485 (Australia)
0800 738 378 (New Zealand)
Fax: (61 3) 9210 5489

Asia Pacific:

Hewlett-Packard Asia Pacific Ltd.
17-21/F Shell Tower, Times Square,
1 Matheson Street, Causeway Bay,
Hong Kong
Tel: (852) 2599 7777
Fax: (852) 2506 9285

Copyright © 1998
Hewlett-Packard Company
Printed in U.S.A. 4/98
5091-2348E