

Microwave Network Analyzer Applications

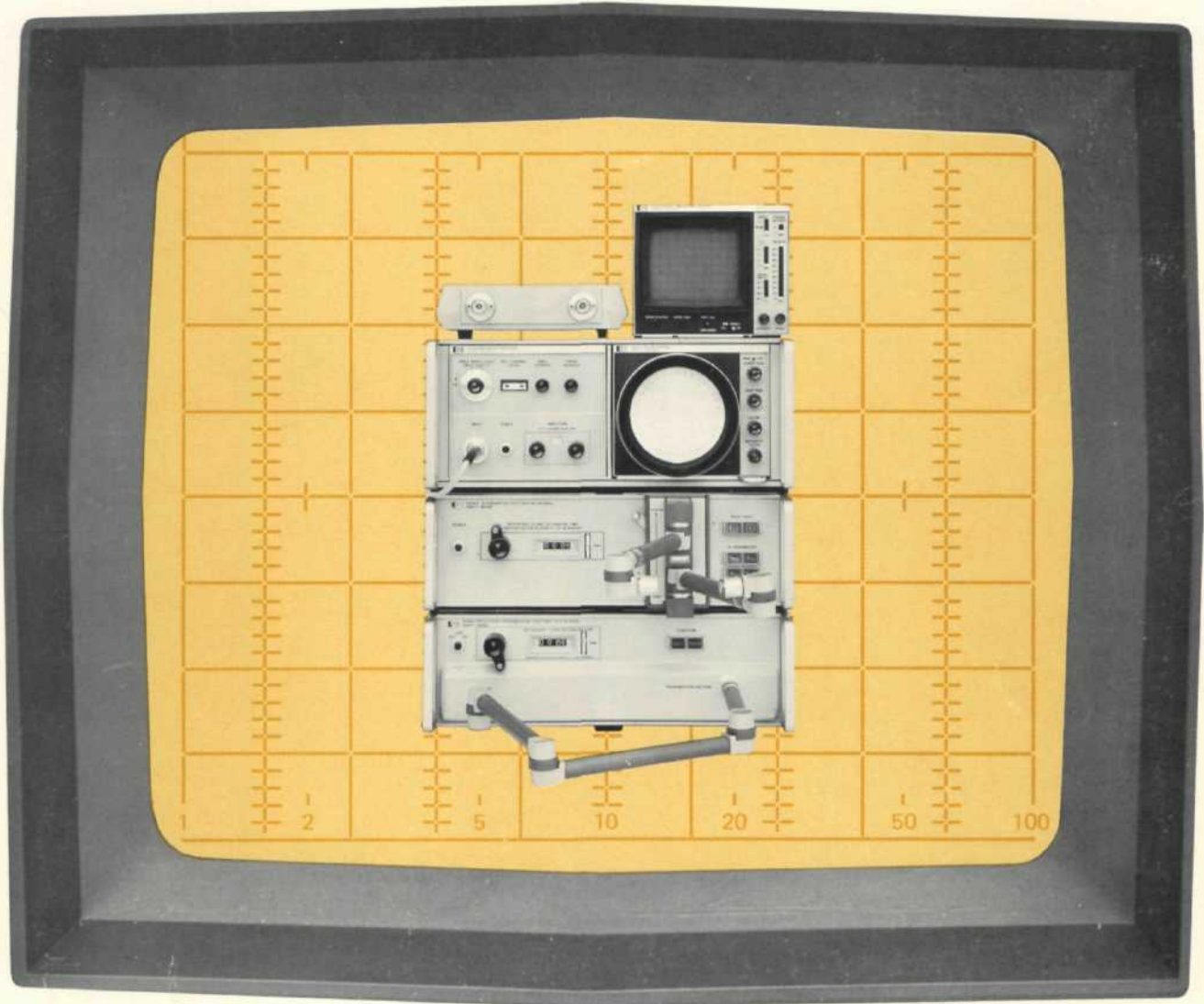

JUNE 1970

HEWLETT **hp** PACKARD

APPLICATION FOR A

GRANT

FOR THE YEAR

ENDING

1994

1994

1994

1994

APPLICATION NOTE 117-1

**MICROWAVE
NETWORK ANALYZER
APPLICATIONS**

Copyright HEWLETT-PACKARD COMPANY 1970
1501 PAGE MILL ROAD, PALO ALTO, CALIFORNIA, U.S.A.

Printed: JUNE 1970
Revised: JANUARY 1978

HEWLETT  PACKARD



HP 8410S Network Analyzer System

TABLE OF CONTENTS

INTRODUCTION

HISTORICAL PERSPECTIVE	ix
A NEW INSTRUMENT	ix
WHAT IT CAN DO FOR YOU	ix
SOME TYPICAL APPLICATIONS	x
Filter Measurements	xi
Semiconductor Measurements	xi
THE APPLICATION NOTE	xiii

I. BASIC CONCEPTS

INTRODUCTION	1-1
REFLECTION MEASUREMENTS	1-1
Reflection Coefficient	1-2
Test Setup	1-2
Impedance	1-3
Smith Chart	1-3
Standing Wave Ratio	1-4
Return Loss	1-4
TRANSMISSION MEASUREMENTS	1-4
Insertion	1-4
Incremental	1-4
Comparative	1-4
Test Setup	1-5
Magnitude and Phase Relationships	1-6
IMPORTANCE OF PHASE INFORMATION	1-7
In Radar Systems	1-7
In Communications Systems	1-7
In Microwave Component Design	1-8
SCATTERING (S) PARAMETERS	1-8
Definition	1-8
Lower Frequency Network Parameters – Z, Y, H	1-8
S Parameters Related to Complex Reflection and Transmission Coefficients	1-9
SUMMARY	1-10

II. THE HP 8410A NETWORK ANALYZER SYSTEM

INTRODUCTION	2-1
SYSTEM COMPONENTS	2-2
Block Diagrams for Reflection-Transmission Measurements Using the HP 8410A Network Analyzer System	2-2
RF SOURCE – SWEEP OSCILLATOR (HP 8690B/8620A)	2-2
Harmonic Frequency Converter (HP 8411A) and Network Analyzer Mainframe (HP 8410A)	2-3
Frequency Translation by Sampling	2-3
Phase Lock	2-3
IF Substitution	2-4

Output Display Plug-In Units	2-5
Phase-Magnitude Display (HP 8412A)	2-5
Phase-Gain Indicator (HP 8413A)	2-6
Polar Display (HP 8414A)	2-6
Output Interpretation	2-7
Reflection Coefficient Related to Complex Impedance Using Smith Chart Overlay	2-8
Transducer	2-8
Operation	2-9
Types of Signal Splitters	2-9
Directivity of Couplers	2-10
Description of the Transducer Units	2-10
Transmission Test Unit – 8740A	2-10
Reflection Test Units – 8741A/8742A	2-10
Waveguide Reflection/Transmission Test Unit – X8747A/P8747A	2-10
Reflection/Transmission Test Set – 8743A	2-11
S Parameter Test Set – 8745A	2-11
Choose Transducer by Application and Frequency Range	2-11
SUMMARY	2-11
8410S Network Analyzer Systems	2-12

III. GENERAL APPLICATION PROCEDURES

INTRODUCTION	3-1
PRE-MEASUREMENT PROCEDURES	3-1
Setup	3-2
Connections	3-2
Test Phase-Lock and Reference Channel Power Level ...	3-3
Power Considerations	3-5
Attenuation Measurements	3-6
Gain Measurements	3-7

IV. HP 8745A TRANSDUCER APPLICATIONS (0.11 – 2.0 GHz)

INTRODUCTION	4-1
CALIBRATION	4-3
Reflection	4-3
Setup	4-3
Typical Results on Two Display Units	4-4
Transmission	4-6
Setup	4-6
Typical Results on Two Display Units	4-6
Benefits	4-7

APPLICATIONS USING THE S PARAMETER	
TEST SET (HP 8745A)	4-8
General Procedure	4-8
General Measurement and Setup	4-9
Transmission Measurement Applications	4-9
Attenuation of a Notch Filter	4-9
Purpose	4-9
Procedure	4-9
Results	4-9
Insertion Phase and Attenuation of a PIN Modulator	4-10
Purpose	4-10
Procedure	4-10
Results	4-10
Elimination of Linear Phase Shift	4-11
High Resolution Measurements of Transistor	
Amplifier Gain	4-11
Purpose	4-11
Pre-Test Procedure	4-12
System Setup	4-12
System Power Levels	4-12
Grid Line Procedure	4-15
Test Procedure	4-15
Results	4-15

V. HP 8743A TRANSDUCER APPLICATIONS (2 – 12.4 GHz)

INTRODUCTION	5-1
CALIBRATION	5-3
Reflection	5-3
Setup	5-3
Typical Results on Two Display Units	5-4
Transmission	5-5
Setup	5-5
Typical Results on Two Display Units	5-6
APPLICATIONS USING THE REFLECTION/TRANSMISSION TEST SET (HP 8743A) ...	5-7
General Procedure	5-7
General Measurement Setup	5-7
Reflection Measurement Applications	5-9
Return Loss in a Cable	5-9
Purpose	5-9
Procedure	5-9
Cancellation of Directivity Vector	5-9
Results	5-9
Transmission Measurement Applications	5-12
Characteristics of a Bandpass Filter	5-12
Purpose	5-12
Procedure	5-12
Results	5-12

VI. HP 8745A S PARAMETER MEASUREMENTS OF SEMICONDUCTOR DEVICES

INTRODUCTION	6-1
Accessories	6-1
Transistor Fixtures — HP 11600B/11602B	6-2
Transistor Bias Supply — HP 8717A	6-2
PROCEDURE FOR TRANSISTOR MEASUREMENTS	6-3
Calibration	6-3
Reflection	6-3
Setup	6-3
Typical Results on Two Display Units	6-4
Transmission	6-5
Setup	6-5
Typical Results on Two Display Units	6-5
Semiconductor Measurements	6-6
Purpose	6-6
Procedure	6-6
Reflection Measurements (S_{11}, S_{22})	6-6
Results	6-6
Transmission Measurements (S_{12}, S_{21})	6-9
Results	6-9
S PARAMETER TRANSISTOR MEASUREMENTS WITH VERY LOW SIGNAL LEVELS	6-10
HP 11607A Adapter	6-11
NEGATIVE IMPEDANCE (TUNNEL DIODE) MEASUREMENTS	6-11
Calibration	6-11
Measurement Setup and Procedure	6-13
Results	6-13
Determination of Tunneling Frequency Range	6-14

VII. 8747A WAVEGUIDE MEASUREMENTS (X Band 8.2 — 12.4 GHz) (P Band 12.4 — 18 GHz)

INTRODUCTION	7-1
PROCEDURE FOR REFLECTION MEASUREMENTS	7-2
Equipment Setup	7-2
Calibration	7-2
Measurement	7-2
PROCEDURE FOR TRANSMISSION MEASUREMENTS ..	7-3
Equipment Setup	7-3
Calibration	7-3
Measurements	7-3
DIELECTRIC CONSTANT DETERMINATION	7-4
Theory	7-4
Procedure	7-5
Results	7-6

VII. FURTHER APPLICATIONS

INTRODUCTION	8-1
REFLECTION MEASUREMENTS	8-1
Impedance	8-1
Antenna	8-1
YIG Resonant	8-2
Determination of Q	8-3
YIG Spheres	8-3
Cavities	8-4
TRANSMISSION MEASUREMENTS	8-5
Passband Insertion	8-5
Gain	8-5
Amplifier	8-5
Antenna	8-6
Description of Q Measurement Overlay	8-7

APPENDIX

I. SCATTERING PARAMETERS TRANSFORMATIONS..	A-1
II. BASIC BLOCK DIAGRAMS	A-3
Network Analyzer (8410A) and Harmonic Frequency Converter (8411A)	A-3
Display Units	
Phase-Magnitude (8412A)	A-4
Phase-Gain Indicator (8413A)	A-5
Polar Display (8414A)	A-6
Transducers	
Reflection/Transmission Test Set (8743A)	A-7
S Parameter Test Set (8745A)	A-8
III. RECOMMENDATIONS ON HANDLING AND CARE OF APC-7 CONNECTORS	A-9
IV. COMMON PRE-TEST PROCEDURES	A-11
BIBLIOGRAPHY	A-13

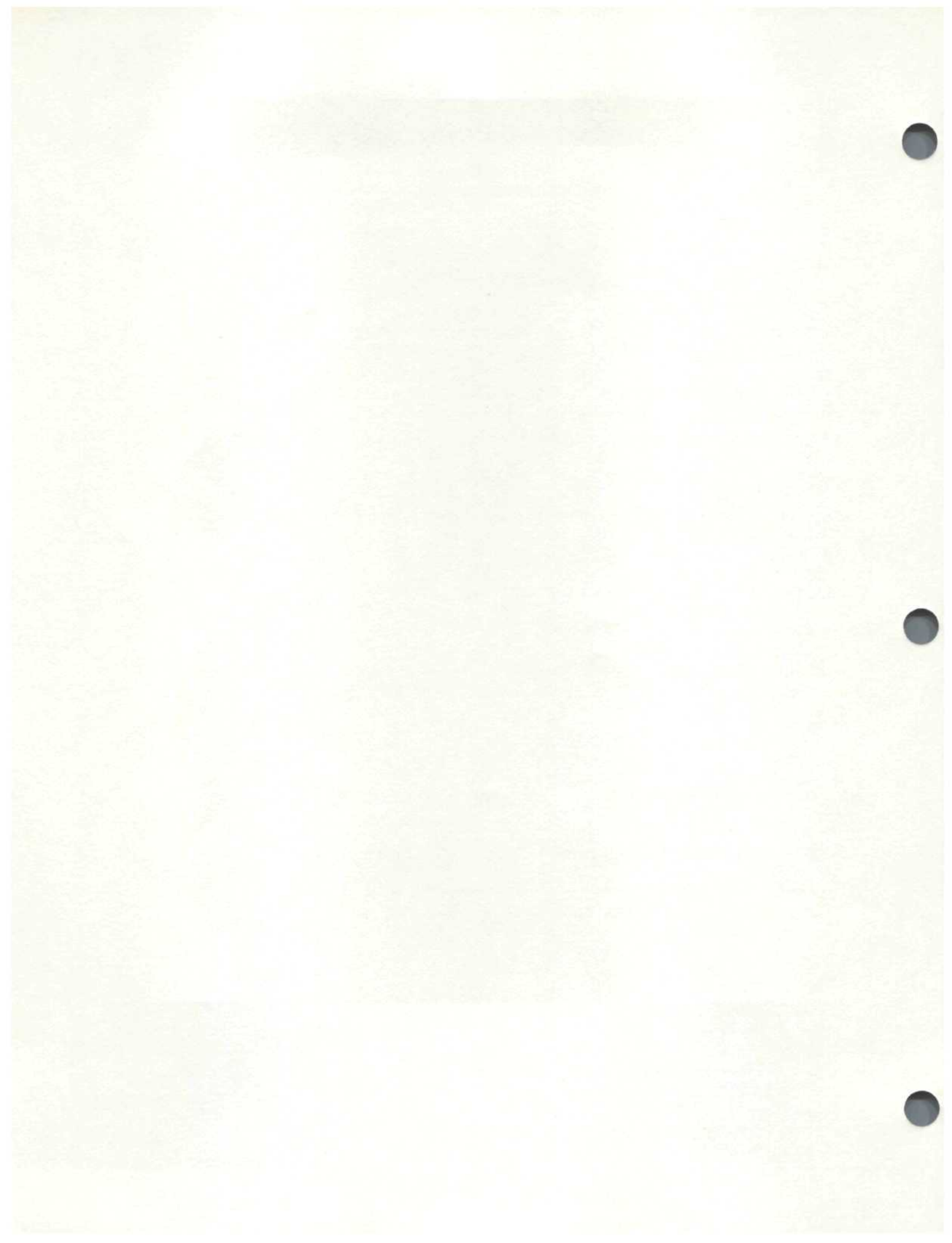

INTRODUCTION

HISTORICAL PERSPECTIVE

For three decades, high frequency engineers have continued to develop improved measuring methods and equipment. This evolutionary growth has resulted from the development of more and more complex high frequency networks and the resulting need to fully characterize or analyze these networks over significant bandwidths. The early slotted line techniques for making fixed frequency, point-by-point, measurements of network parameters was both tedious and time-consuming. In addition, this type of measurement greatly restricted the amount of data available to the engineer. For example, resonances between points of measurement are missed and the skirt response of filters and amplifiers is not adequately determined. These limitations prompted the development of swept-frequency techniques which now offer an indispensable tool for optimizing designs.

A NEW INSTRUMENT

The Hewlett-Packard 8410 series Network Analyzer represents a *major breakthrough in this evolutionary development of microwave measurement instrumentation*. This system incorporates the advantages that swept techniques offer in addition to many new features that now permit the microwave engineer to *completely characterize these complex networks with no degradation of accuracy and in less time than it previously took to obtain point-by-point magnitude-only measurements*.

WHAT IT CAN DO FOR YOU

The HP 8410 is truly a network analyzer since it characterizes networks or devices in terms of their complex small-signal scattering or S parameters, much like the low frequency engineers characterize their networks in the familiar impedance or admittance parameters. Measuring scattering parameters involves measuring the ratio of the magnitudes and relative phase angles of response and excitation signals at the ports of a network with the other ports terminated in a specified characteristic or reference impedance. Once the network parameters of a microwave device or "black box" are known, the engineer then knows how this device will operate when tied into an even more complex network or grouping of black boxes. This is very important when using solid-state active devices at microwave frequencies since there is usually little extra power available and to insure optimal performance of a system, the individual components of the system have to be mated as perfectly as possible. The information required to do this can be obtained from the 8410 Network Analyzer.

SOME TYPICAL APPLICATIONS

Figures I-1 and I-2 illustrate two measurements made with the network analyzer on a filter designed to operate in the microwave frequency range.

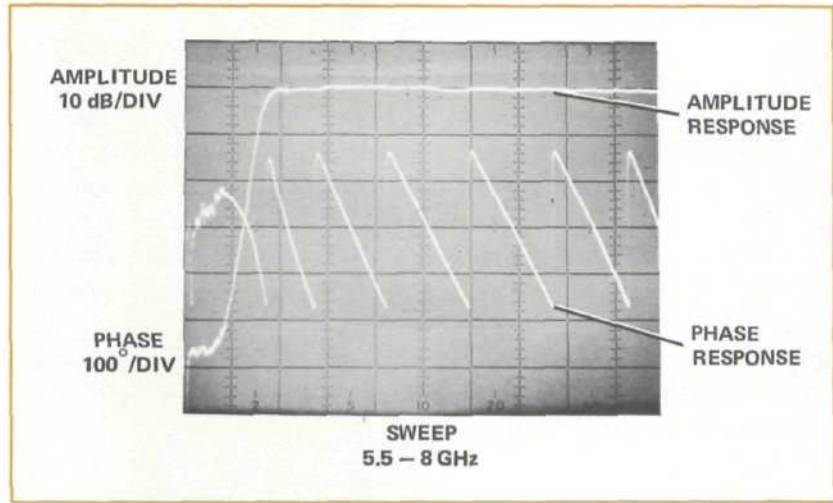

Figure I-1

Amplitude and phase response of a 6-8 GHz bandpass filter showing the flatness of the passband, the skirt response and the nonlinear phase shift in the skirt region, the phase linearity in the passband, and the rejection out of the passband. Approximately 2 dB of ripple can be seen in the passband. The linear phase shift shows constant group delay for the frequencies in the passband assuring low distortion for information. The steep skirt response provides high signal rejection for frequencies immediately outside the passband. Scale: 10 dB/cm, 180°/cm.

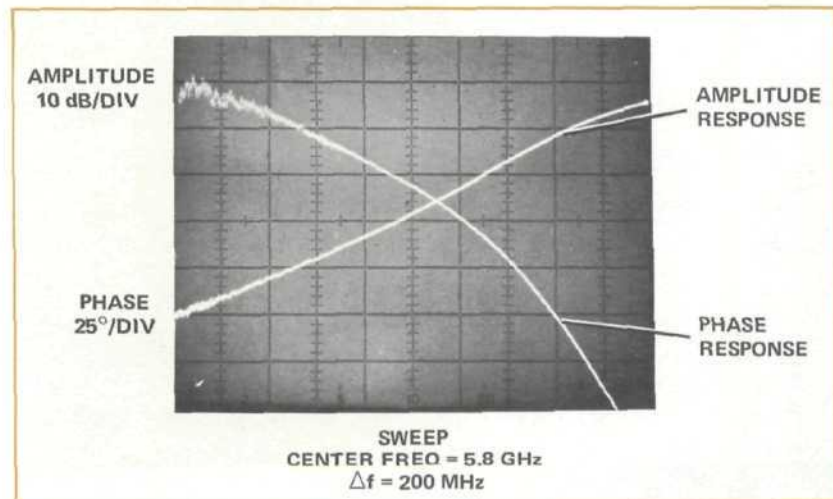

Figure I-2

The amplitude and phase response of the skirt region of a 6-8 GHz bandpass filter swept on Δf sweep of 300 MHz about 5.8 GHz. This display allows better resolution of the phase response at the skirt region. It shows non-linearity of phase and variation in slope of the amplitude skirt. Vertical scale: 10 dB/cm, 25°/cm.

These displays were obtained by using one of the output display units — Phase-Gain Indicator — tied into an oscilloscope. Another output display plug-in unit, the Phase-Magnitude Display, will yield the same information directly using its dual-channel scope.

FILTER MEASUREMENT

These figures illustrate the type of output display obtainable when using the 8410 Network Analyzer. The display actually shows the amplitude and phase characteristics of the filter as a function of frequency. Such results are of vital concern to the circuit designer. The steepness of the "skirts" of the amplitude response indicates how well the filter rejects frequencies out of the passband. The linearity of the phase response indicates how the filter will affect the transmission of information through the filter. Group delay is a convenient indication of nonlinear phase shift. This nonlinearity causes distortion in communication links. Thus, by knowing the group delay, communication engineers can accurately predict the distortion which will degrade the quality of transmitted information. The swept-capability of the 8410A allows for real-time measurements of phase and amplitude and thus enables equipment adjustment during the test. If this filter were tunable, it could be tweaked for optimal performance in a matter of minutes over the entire frequency range of interest.

SEMICONDUCTOR MEASUREMENT

One of the characteristics of interest when measuring semiconductor devices is the gain of the device under certain bias conditions. Using the network analyzer, along with the peripheral equipment designed to facilitate measurements, the gain measurement of a transistor or an IC amplifier becomes an easy task. The forward transmission parameter, S_{21} , can be determined with push-button ease. The required test setup circuitry is contained within the peripheral equipment and by merely selecting the proper pushbutton, in this case S_{21} , internal switching circuits are set up and the gain of a total amplifier or an individual stage can be displayed as in Figure I-3. This polar display yields both magnitude and phase information for the amplifier.

This particular display unit is also used if impedance information is desired. In Chapter II, the relationship between complex reflection coefficient and impedance is developed. Thus, if a display unit can display reflection coefficients, it can easily be converted to display impedance information by simply inserting a Smith Chart overlay on the CRT face. This is illustrated in Figure I-4. The input impedance information is of great concern for the amplifier designer who tries to match the amplifier to the previous stage for maximum power transfer.

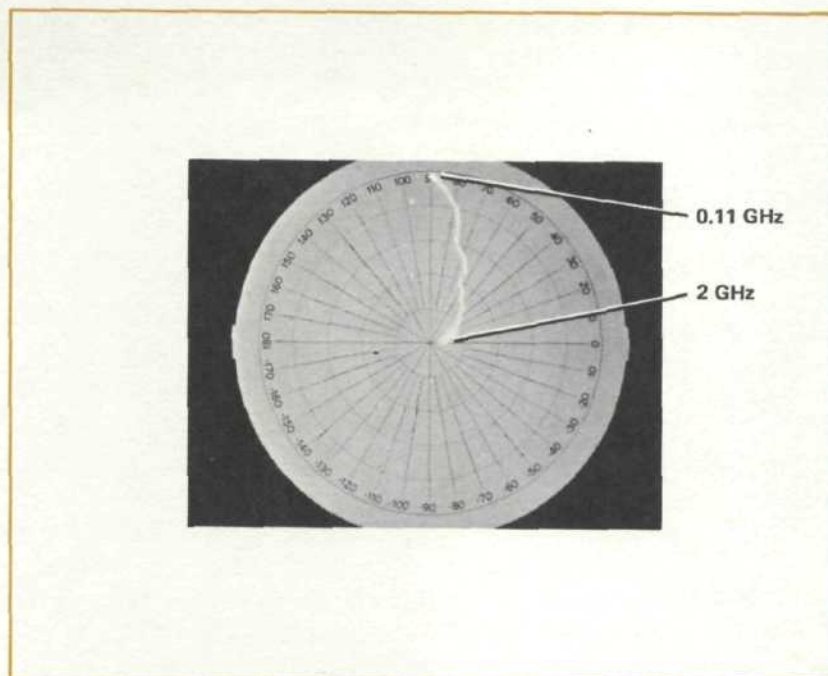

Figure I-3

Swept polar display of the forward transmission voltage gain (S_{21}) of a transistor from 0.11 GHz to 2 GHz. Full scale voltage gain is set by an IF attenuator to be 5.0. Intensity markers may be used to pinpoint the frequency of unity gain on the display.

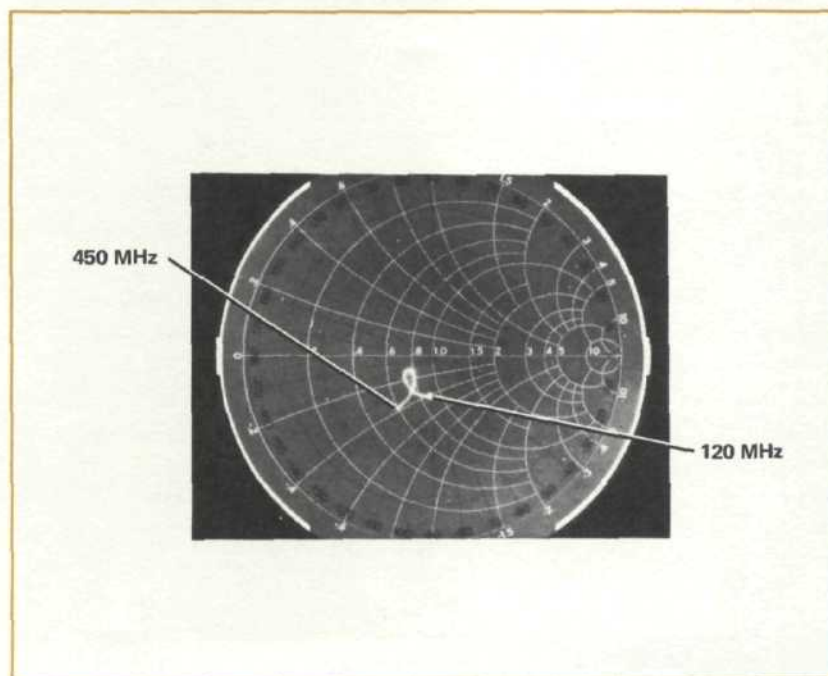

Figure I-4

Input impedance of a microcircuit preamplifier swept tested from 120 MHz to 450 MHz. The small loop at about midway in the response could be indicative of a resonance at that frequency. Complex impedance can be read directly from the Smith Chart overlay. Full scale = 1.0.

THE APPLICATION NOTE

Information in this note applies to both the 8410A and the 8410B versions of the Network Analyzer. The basic difference between the 8410A and its replacement, the 8410B, is that the 8410B includes a source interface which, when used with a compatible sweep oscillator such as the HP 8620C, allows continuous multi-octave frequency sweeps without adjustment.

The following diagram shows connections between the 8410B and 8620C. Connections from SOURCE CONTROL to PROGRAMMING, and between FREQ REF INPUT and FREQ REF are required for continuous multi-octave operation. The connection between the source SWEEP OUT and the 8412A Phase/Magnitude Display SWEEP IN is required for x-axis deflection. Use of the retrace display blanking and z-axis marker connections is optional.

Notable changes in the product line since this note was first printed include introduction of the 86222A/B (0.10–2.4 GHz) and 86290A/B (2–18 GHz) Sweeper Plug-ins, the 8746B (2–12.4 GHz) S-Parameter Test Set and 11608A Transistor Fixture for testing active devices, and Option 018 for the 8411A Harmonic Frequency Converter and 8743A Reflection/Transmission Test Unit to extend frequency coverage of these units to 18 GHz.

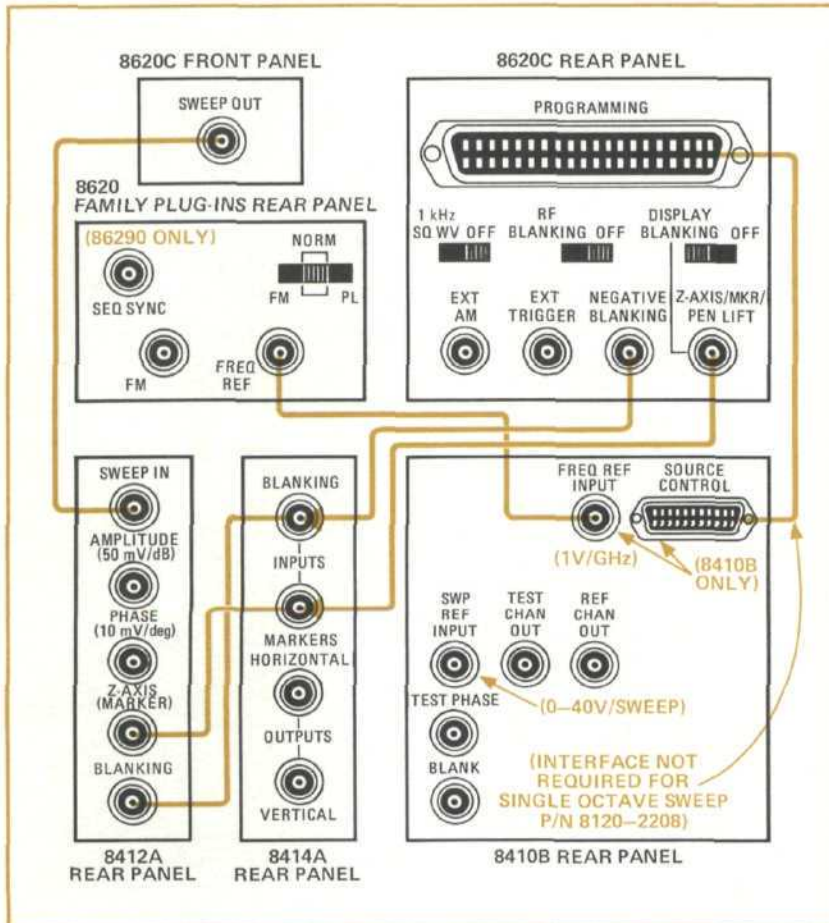
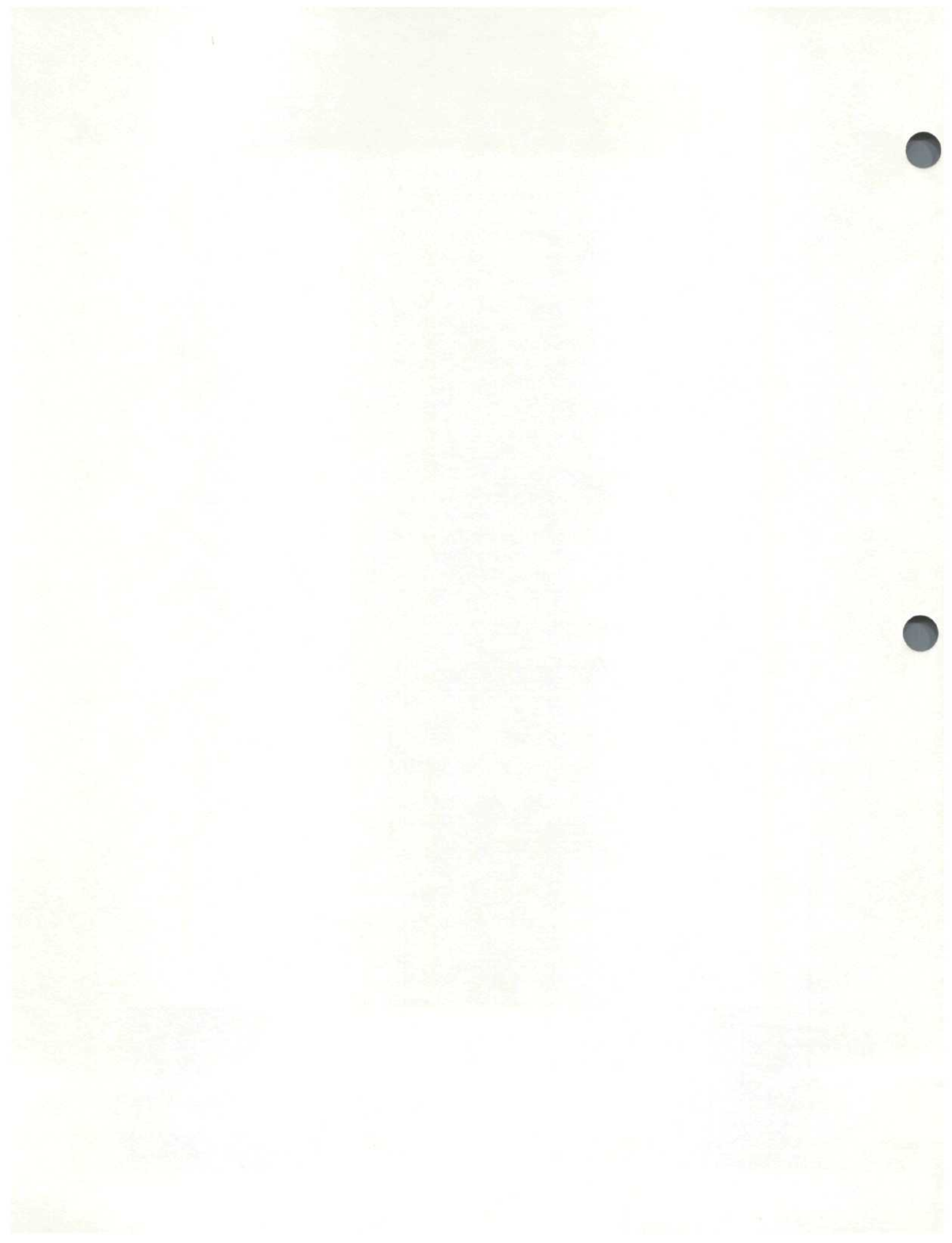

Figure I-5. Connections Between the 8410B and 8620C



CHAPTER I

BASIC CONCEPTS

INTRODUCTION¹

Complete characterization of microwave devices is becoming more and more necessary for the microwave engineer. Lighter and smaller microwave systems can be built by combining and cascading devices, provided the designer knows exactly how each individual component or network behaves. Optimal system performance can then be predicted.

This characterization of microwave devices is accomplished by two basic measurements, reflection and transmission, each yielding both magnitude and phase information. These basic microwave measurements can be performed with the HP 8410A Network Analyzer.

Since these measurements are fundamental for working in the microwave field, it is important to understand them and how they relate to network parameters and commonly used terms in the microwave vocabulary.

REFLECTION MEASUREMENTS

At microwave frequencies, a standing-wave pattern will be distributed along a transmission line when there is a load connected to it that is not equal to the line's characteristic impedance. The standing-wave pattern is composed of the sum of the voltage wave incident on the load, E_i , and the voltage wave reflected from this load or device under test, E_r . At the load, the ratio of E_r to E_i , and the phase angle between them are uniquely determined by the load impedance. This ratio, called the reflection coefficient, is therefore a convenient measure of the deviation of the load impedance from the characteristic impedance,

$$\Gamma = \frac{E_r}{E_i} = \rho/\phi$$

where ρ is the magnitude and ϕ is the phase relationship of this ratio.

The reflection coefficient, being a vectorial quantity having magnitude and phase information, fully describes that load impedance terminating the transmission line. To measure this ratio, a reflectometer system is used which has the capability of measuring a portion of the incident and reflected signals in a transmission line.

¹This section is designed to instruct the readers of this A/N who have had little microwave experience to ensure that they will be able to obtain the greatest possible use from the 8410A system.

Figure 1-1 illustrates both a block diagram setup for a reflection measurement and how such a measurement can be made using the 8410A Network Analyzer.

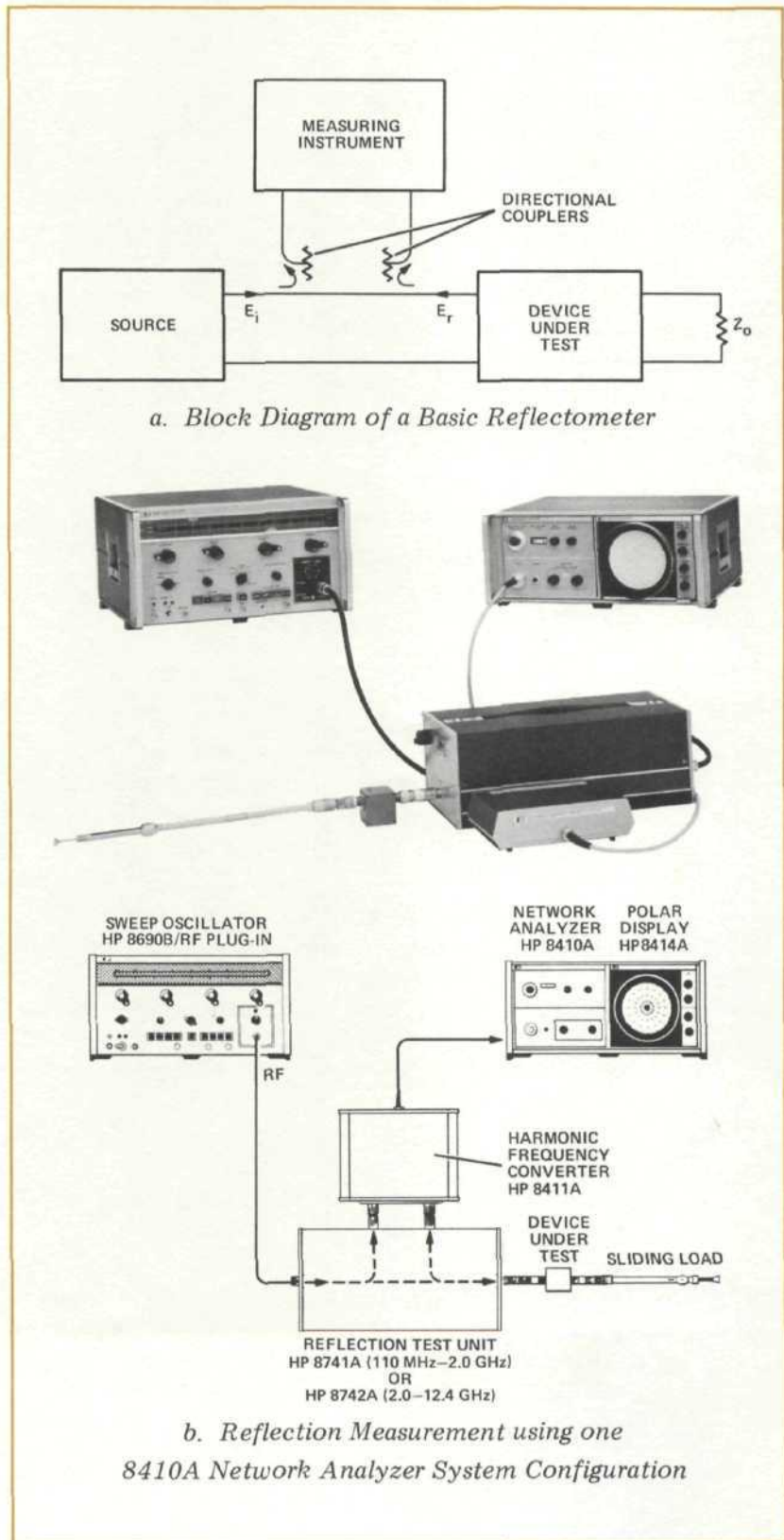

Figure 1-1. Reflection Measurement Test Setup

Figure 1-2 illustrates a typical result of an output reflection measurement of a transistor between 0.11 and 2 GHz. In this case, the Polar Display plug-in (HP 8414A) was used.

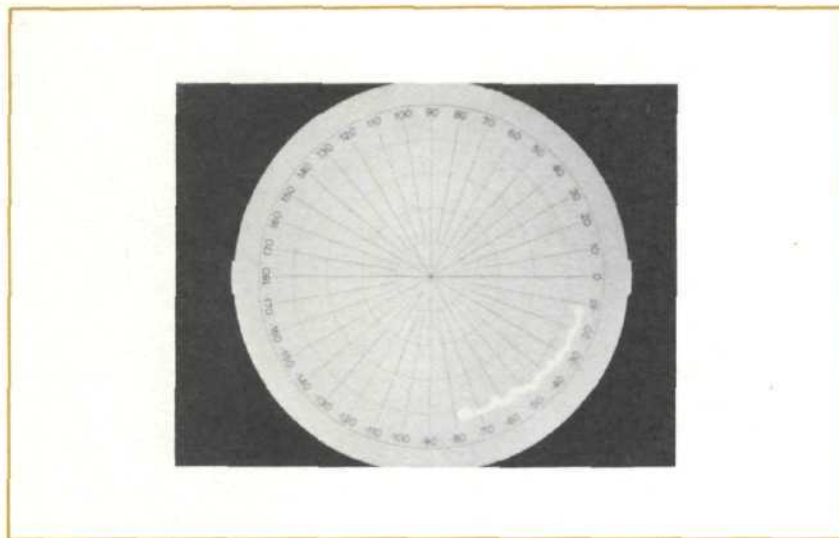

Figure 1-2. Typical Result of a Reflection Measurement

Both the magnitude and phase of the reflection coefficient are displayed on this unit. From this information, the normalized input impedance of the device under test can be obtained using the relationship:

$$\frac{Z_{IN}}{Z_0} = \frac{1 + \Gamma}{1 - \Gamma}$$

This relationship led Phillip H. Smith to develop the Smith Chart shown in Figure 1-3.² This chart eliminates tedious calculations and facilitates design procedures.

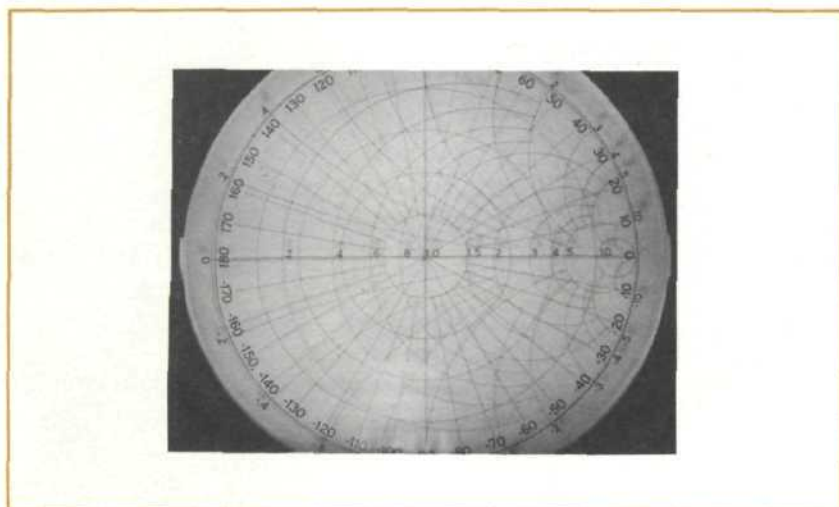

Figure 1-3. Smith Chart Overlay Over the 8414A CRT

²For a more complete discussion of the Smith Chart, refer to any standard Microwave textbook such as "Microwave Theory and Applications," Stephen Adam, Prentice-Hall Inc., Englewood Cliffs, N.Y., 1969, pp. 25 ff.

This chart is supplied as a plastic overlay for the CRT of the 8410A Network Analyzer's Polar Display. In this way, the input impedance of the device under test can be displayed.

From the basic ratio,

$$\frac{E_r}{E_i} = \rho / \phi$$

other common terms in the microwave dictionary can be defined:

$$\text{Standing Wave Ratio} = \frac{1 + \rho}{1 - \rho}$$

$$\text{Return Loss in dB} = -20 \log_{10} \rho$$

Rapid conversions between return loss, standing wave ratio and reflection coefficient magnitudes can be accomplished by using a Reflectometer Calculator, available from Hewlett-Packard.

TRANSMISSION MEASUREMENTS

Transmission measurements are typically categorized into three groups: *insertion*, *incremental* and *comparative*. In all of these, the point of interest is the effect that a device in the line has on the transmission of energy down the line.

Insertion tests are those in which one measures the magnitude and phase before and after the device under test is inserted into the measurement system. The measurements of amplifier gain or filter attenuation are typical insertion transmission measurements.

Incremental tests are made with the test device already inserted in the system and measurements of phase shift or gain versus such factors as temperature or time are made. This type of measurement is typically used in evaluating equipment during a life or environmental test.

Comparative tests determine the relative phase and magnitude difference between the test device and another one, which could be taken as a standard. This type of measurement is used when one wishes to select matched amplifiers or cables.

Figure 1-4 illustrates both a block diagram setup for a transmission measurement and how such a measurement can be made using the 8410A Network Analyzer.

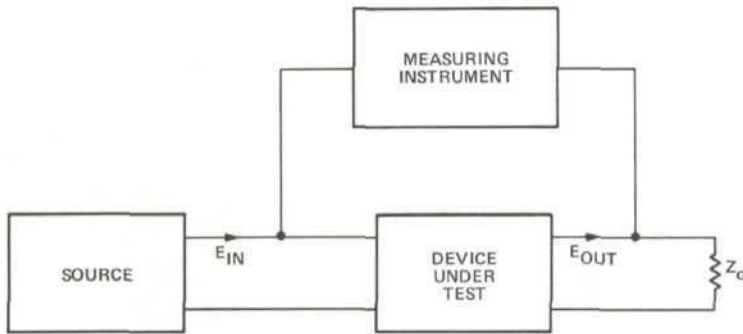

a. Block Diagram

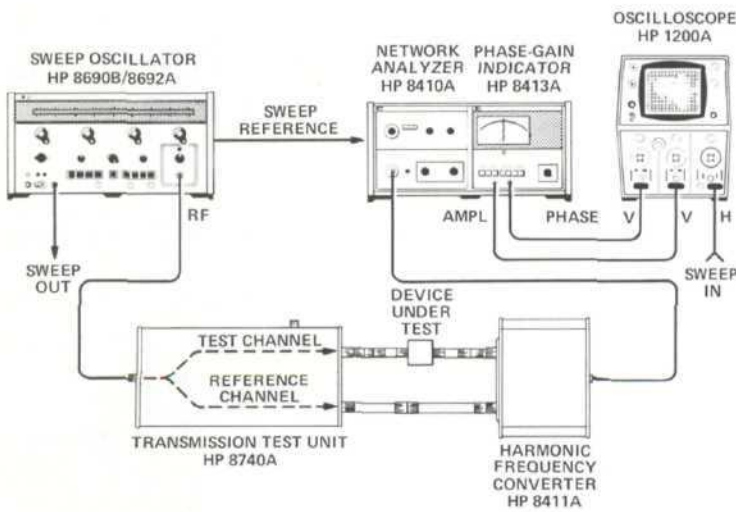

b. Transmission Measurement Using one 8410A Network Analyzer System Configuration

Figure 1-4. Transmission Measurement Test Setup

Since the two voltages, E_{IN} and E_{OUT} , are vector quantities, their relationship for one frequency might be as in Figure 1-5.

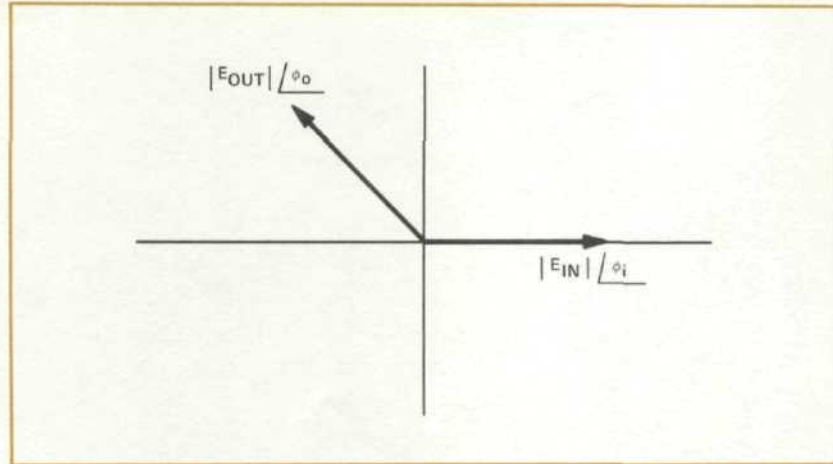

Figure 1-5. Typical Magnitude and Phase Relationships In a Transmission Test

In this figure, both the magnitude and phase relationship between these vectors are seen. In an actual test, however, it is the ratio of these two vectors that is of importance. This ratio,

$$\frac{E_{OUT}}{E_{IN}} = \frac{|E_{OUT}|}{|E_{IN}|} \angle \phi_o - \phi_i$$

can be displayed versus frequency on an oscilloscope or on any display plug-in unit of the 8410A system. Figure 1-6 illustrates a typical magnitude and phase response as displayed on an oscilloscope when the device under test is a bandpass filter.

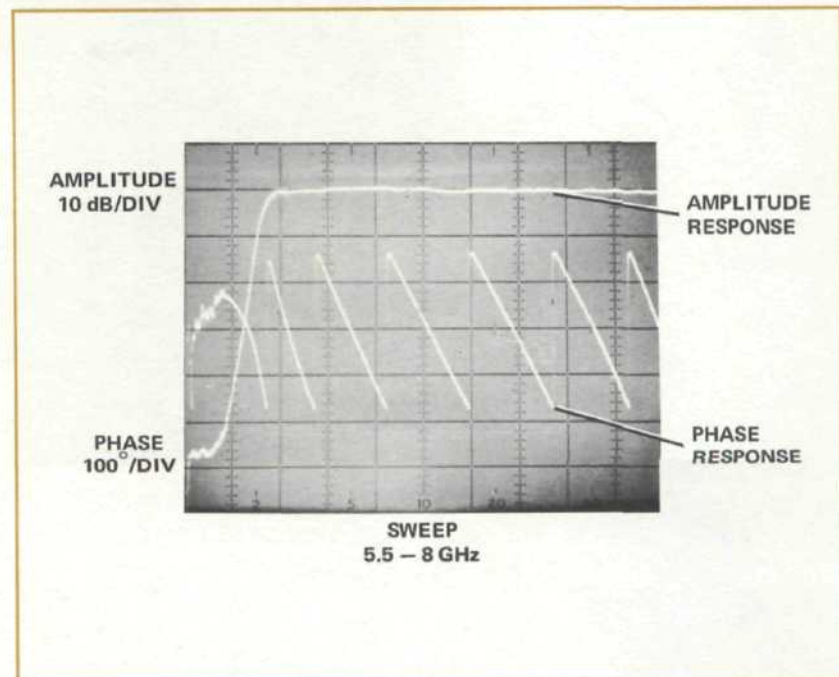

Figure 1-6. Typical Output Display for a Bandpass Filter

This display illustrates several items of interest:

- a. The magnitude response displayed in decibels, or

$$\text{ATTENUATION} = 20 \log_{10} \frac{|E_{OUT}|}{|E_{IN}|}$$

b. The amount of attenuation introduced into the circuit in the pass-band is referred to as insertion loss. This loss is due to the fact that perfect components are not available.

c. The phase response of this filter has the sawtooth shape due to the network analyzer's design. The phase angle range is ± 180 degrees or 360 degrees. Thus, the total phase shift introduced into the circuit in the passband equals the number of 360 degree swings shown on the display. As mentioned in the Introduction, distortion of signals through the filter result if the phase response is non-linear. The phase information available with the 8410A Network Analyzer is, therefore, of great concern to the communication engineers who are interested in the amount of nonlinearity introduced into a system by a device such as this filter. A convenient measure of this nonlinearity is group delay or slope of the phase response ($d\phi/d\omega$). Linear phase response would thus exhibit constant group delay.

THE IMPORTANCE OF PHASE INFORMATION IN MICROWAVE MEASUREMENTS

The phase information obtainable when using the 8410A Network Analyzer for transmission and reflection measurements has many uses.

PHASE INFORMATION IN RADAR SYSTEMS

Phased-array antennas that can be electronically scanned for rapid target acquisition require precise phasing of signal energy to elements in the array to provide maximum power output and to aim the beam precisely. These phased-array systems also require accurate phase matching of the transmission lines used so the signals are in the correct phase relationships needed for proper system operation.

PHASE INFORMATION IN COMMUNICATION SYSTEMS

We have already seen that phase information is needed to maintain constant "group delay" for the elimination of distortion of the transmitted information through filters. In addition, many sensitive receivers used in space communications use phase modulation. The phase sensitivity of receivers and related components to factors such as vibration, temperature, and time must be known.

PHASE INFORMATION IN MICROWAVE COMPONENT DESIGN

Correct phase information is absolutely necessary for successful design of microwave components. For example, consider the situation encountered in the designing of a tuned filter. It is desirable to determine the pole-zero plot of this filter; i.e., the frequencies at which the filter's characteristic equation goes to infinity or zero. This information can be obtained from the filter's amplitude response if the dynamic range of the measuring instrument is wide enough, but measuring steep skirt response is difficult in almost any application. However, the entire pole-zero response of the filter can be determined easily by measuring the phase slope through resonance of the filter. Phase-measuring capability can eliminate the need for extremely sensitive, narrow bandwidth instrumentation to characterize the response of high-Q devices over wide dynamic ranges.

SCATTERING PARAMETERS³

A network can be analyzed operationally by studying its response to applied signals. Figure 1-7 shows a simple two-port network that can be characterized by applying a signal at the input port and noting the response of the network. Mathematically, one could describe this process by stating that a network can be characterized in terms of the dependent and independent variables at each port.

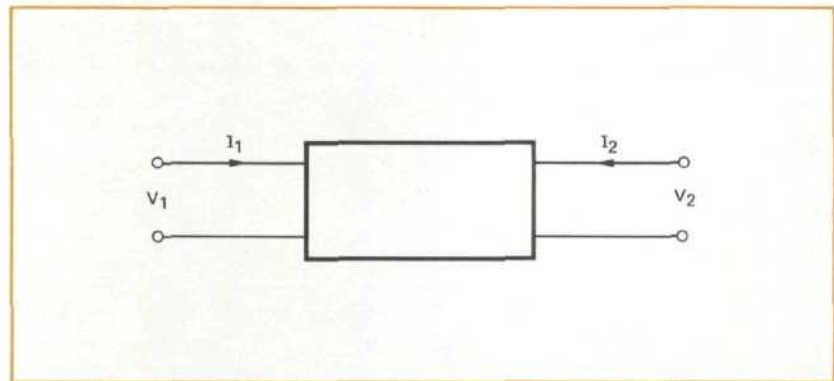

Figure 1-7. Simple Two Port Network

At lower frequencies, at least three sets of parameters have been developed to characterize two-port networks. These are referred to as Z, Y and H parameters. The resulting equations for the Z parameters are as follows:

Z-Parameters

$$V_1 = Z_{11} I_1 + Z_{12} I_2$$

$$V_2 = Z_{21} I_1 + Z_{22} I_2$$

³ Additional information about these parameters can be found in HP Application Note 77-1, "Transistor Parameter Measurements" and HP Application Note 95-1, "S-Parameter Techniques."

In the absence of additional information, four measurements are required to determine the four parameters Z_{11} , Z_{12} , Z_{21} and Z_{22} . Each measurement is made with one port of the network excited by a voltage source while the other port is left open. For example, Z_{11} , the input impedance of the network, is the ratio of the independent variable, V_1 , to the dependent variable, I_1 , with the output terminals left open as shown in the equation

$$Z_{11} = \frac{V_1}{I_1} \quad I_2 = 0 \text{ (output open)}$$

All three of these parameter sets rely on the measurement of voltages and currents with terminals being open or shorted. This is difficult to do even at RF frequencies where lead inductance and stray capacitance make open and short circuits difficult to obtain.

At higher frequencies these measurements typically require tuning stubs, separately adjusted at each measurement frequency, to reflect open or short circuit conditions to the device terminals. Not only is this inconvenient and tedious, but a tuning stub shunting the input or output may cause a transistor to oscillate, making the measurements difficult and invalid.

We have seen that, in general, complex transmission and reflection coefficients completely characterize any device or network. Transmission and reflection parameters – attenuation or gain, phase shift and complex impedance – can also be described in terms of linear parameters called scattering or “S” parameters. As with the other traditional sets of parameters, once these characteristic S-parameters are known one can predict the response of cascaded or parallel networks accurately and completely.

These parameters are usually measured with the device inbedded between a 50-ohm load and a 50-ohm source and there is very little chance for oscillations to occur.

For the two port network shown in Figure 1-8, there are four scattering parameters: S_{21} , S_{12} , S_{11} and S_{22} . The forward and reverse transmission parameters, S_{21} and S_{12} , are the magnitude ratio and phase shift of the signal flow between ports when the signal source is attached to one port and the opposite port is terminated in the characteristic impedance, Z_o of the line.

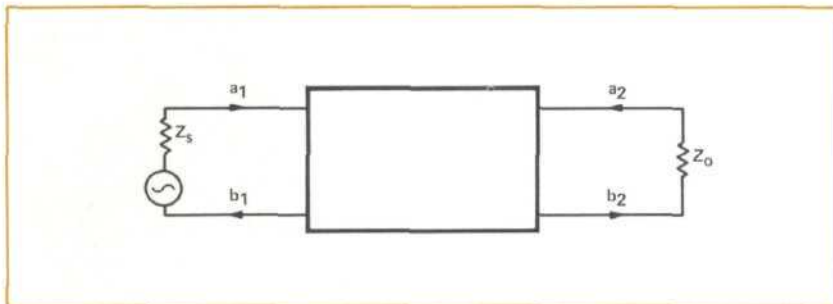

Figure 1-8. Two-Port Network

The reflection parameters, S_{11} and S_{22} at the input and output ports, are determined under the same test conditions, i.e., the signal source attached to the input or output port with the opposite port terminated in the characteristic impedance, Z_0 , of the line. These parameters, S_{11} and S_{22} obtained from the basic microwave reflection measurement, are directly related to the complex impedance of the device by the equation:

$$\frac{Z_{IN}}{Z_0} = \frac{1 + S_{11}}{1 - S_{11}} \quad \text{OR} \quad S_{11} = \frac{Z_{IN} - Z_0}{Z_{IN} + Z_0}$$

Relating this more directly to the previous discussion of incident and reflected voltages, we define the independent variables a_1 and a_2 as the normalized incident voltages and the dependent variables b_1 and b_2 as the normalized reflection voltages. Thus,

$$a_1 = \frac{\text{Voltage Wave Incident on Port 1}}{\sqrt{Z_0}}$$

$$a_2 = \frac{\text{Voltage Wave Incident on Port 2}}{\sqrt{Z_0}}$$

$$b_1 = \frac{\text{Voltage Wave Reflected from Port 1}}{\sqrt{Z_0}}$$

$$b_2 = \frac{\text{Voltage Wave Reflected from Port 2}}{\sqrt{Z_0}}$$

The resulting linear equations describing the two-port network are:

$$b_1 = S_{11}a_1 + S_{12}a_2$$

$$b_2 = S_{21}a_1 + S_{22}a_2$$

S_{11} represents the input reflection coefficient with the output port terminated in the characteristic impedance of the line. This sets $a_2 = 0$.

$$S_{11} = \frac{E_{r1}}{E_{i1}} \quad a_2 = 0$$

Appendix I contains a complete set of S-parameter transformations to the Z, Y, or H parameters for those who are interested in a ready reference.

SUMMARY

This chapter discussed the basic concepts underlying the types of measurements possible with the 8410A Network Analyzer. Figure 1-9 illustrates the various network parameters that can be obtained from transmission and reflection measurements of the device under test.

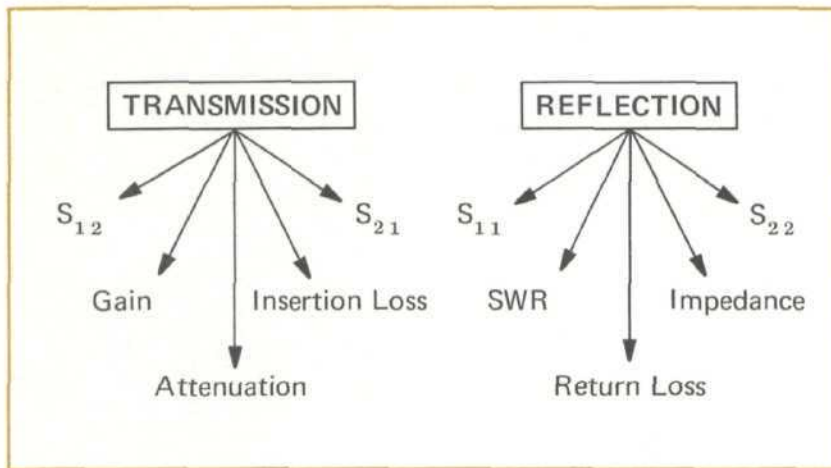
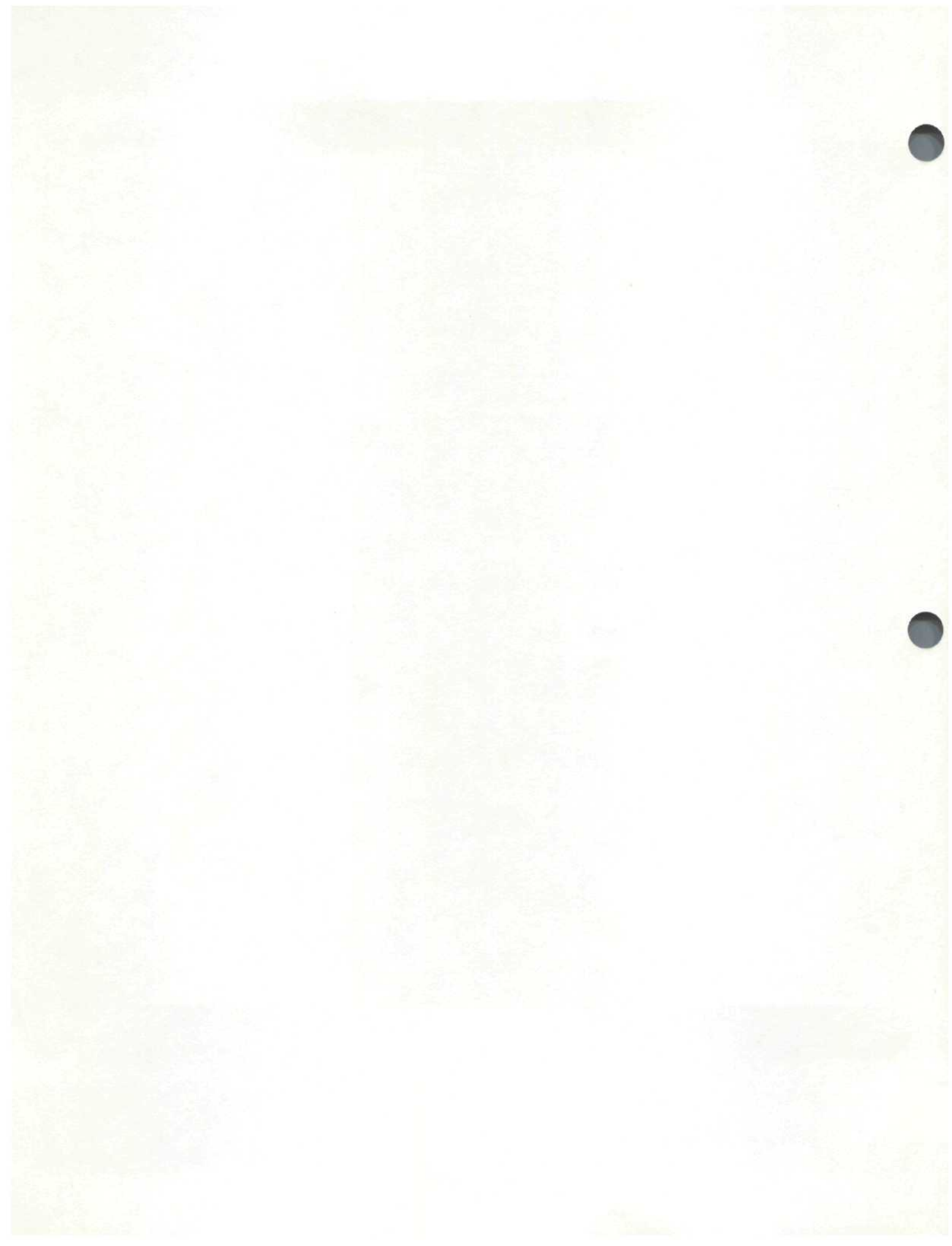

Figure 1-9. Network Parameters from Transmission & Reflection Measurements



CHAPTER II

THE HP 8410A NETWORK ANALYZER SYSTEM

INTRODUCTION

In Chapter I, two separate configurations of the network analyzer equipment were used in typical transmission and reflection measurements. Referring, therefore, to the 8410A as a system is perhaps a misnomer since the equipment can be assembled in several configurations depending on the frequency range and application. Basically, however, the 8410A system can be described as a dual channel receiver which performs the function of a ratiometer between two signals and then displays these complex ratios on one of the output display units available.

The following block diagrams illustrate how the components of the network analyzer are connected for either reflection or transmission measurements.

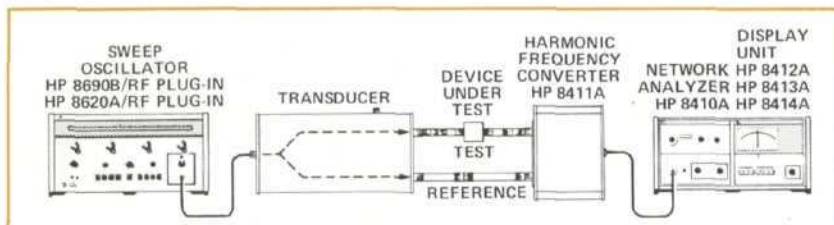

Figure 2-1 (a). Transmission Measurement Using
A Power Splitter in the Transducer

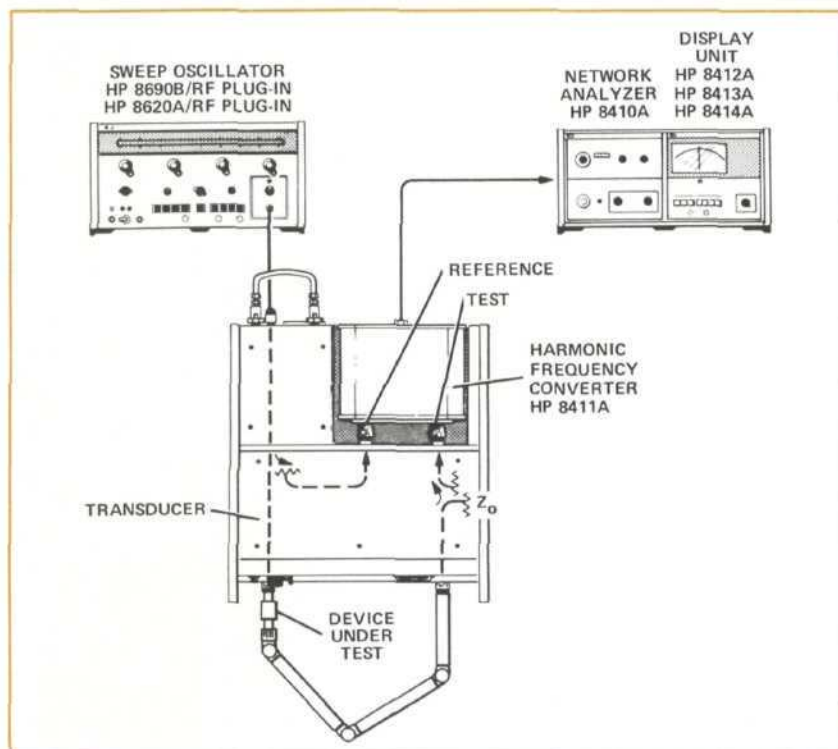

Figure 2-1 (b). Transmission Measurement Using
Two Directional Couplers in the Transducer

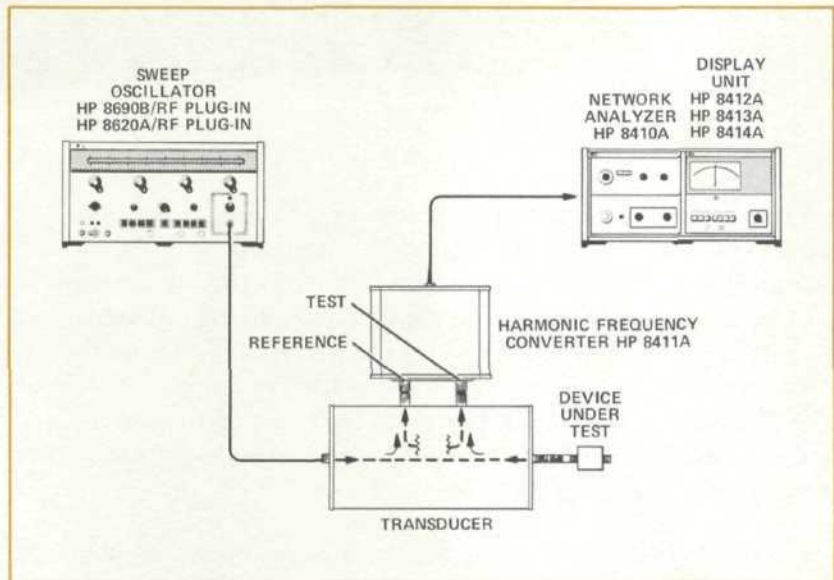
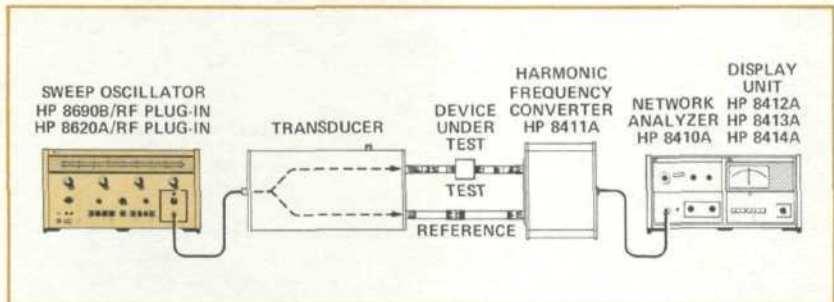

Figure 2-2. Reflection Measurement

The system will now be discussed component by component to ensure a better understanding of the individual parts and their role in the overall network analyzer system.

SYSTEM COMPONENTS

THE RF SOURCE – SWEEP OSCILLATOR



In these basic test setups, the RF signal source shown is the HP 8690B/8620A Sweep Oscillator with the 8690/8630 series RF plug-ins. While all HP sweep oscillators are designed to provide optimal results with the network analyzer system, however, other sweep oscillators are usable if they meet the following specification:

RF Output: +15 dBm to -6 dBm

Signal Purity: Spurious signals should be at least 20 dB below the fundamental.

Sweep Characteristics: Uniform sweep rate that is variable between 15 and 150 MHz per millisecond. An additional important requirement is at least a 3 millisecond pause at the start frequency prior to each sweep to allow the network analyzer to initially lock, ensuring repeatable measurements.

Phase Lock: To improve phase-lock operation at high sweep rates the sweep oscillator should furnish a voltage proportional to its output frequency. For multioctave sweeps the 8410B requires 1 volt/GHz at the FREQ REF INPUT connector. The 8410B multipin SOURCE CONTROL connector is a digital interface required for multioctave and multiband operation.

Stable RF Frequency Output: This is of prime importance to the tuning and tracking of the network analyzer.

THE HARMONIC FREQUENCY CONVERTER (HP 8411A) AND NETWORK ANALYZER MAINFRAME (HP 8410A)

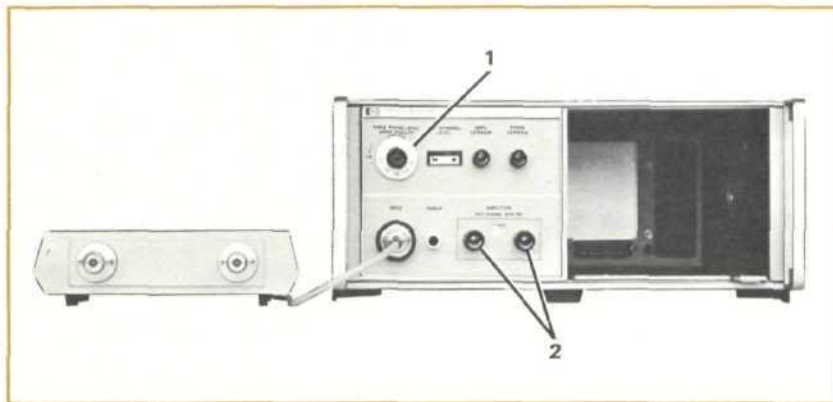

Figure 2-3. The Harmonic Frequency Converter and Network Analyzer Mainframe

Every element in this network analyzer system is necessary for the system's operation, but these two units serve as the core of the entire system. The information from the test and reference channels in the transducer enters the harmonic frequency converter/network analyzer where, by harmonic sampling, the input signal is converted to a fixed IF frequency, at which low frequency circuitry can measure amplitude and phase relationships. Sampling has the advantage that a single system can operate over an extremely wide input frequency range; in this case, the range is 110 MHz to 12.4 GHz.

The amplitude and phase detectors are in the display units. The mainframe contains the phase lock oscillators and IF amplifiers necessary for automatic gain control as well as the system power supplies. A simplified block diagram of these units is shown in Figure 2-4.

To make the system capable of swept-frequency operation, the internal phase-lock loop, shown in Figure 2-4 keeps the reference channel tuned to the incoming signal. The phase-lock loop ensures repeatability and accuracy of test measurements since it automatically tunes back and forth across the octave frequency band selected in order to obtain a constant IF frequency. The user selects the frequency band by means of the frequency range switch (No. 1, Figure 2-3). The AUTO position incorporated in the 8410B is selected when multioctave sweep oscillator plug-ins such as the 86222 or 86290 are used.

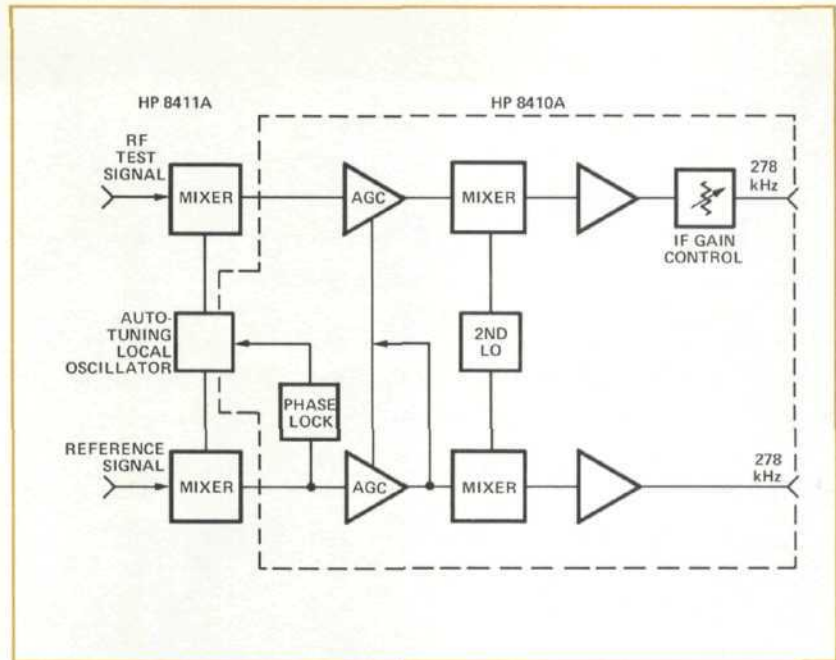

Figure 2-4. Simplified Block Diagram of the Harmonic Frequency Converter (8411A) & Network Analyzer (8410A)

The IF signals reconstructed from the sampler outputs are both 20 MHz signals. Since frequency conversion is a linear process, these signals have the same relative amplitudes and phases as the microwave reference and test signals. Thus, gain and phase information are preserved and all signal processing and measurements take place at a constant frequency.¹

A leveled signal source is unnecessary for this network analyzer. As can be seen from Figure 2-4, there are two matched AGC (Automatic Gain Control) amplifiers in the network analyzer. One of these amplifiers keeps the signal level of the reference channel constant and applies an error signal to a matched amplifier in the test channel so that the test signal level does not change when common-mode variations occur. This then allows the ratio of the test channel to the reference channel signals to be measured directly on one of the plug-in output display units.

By down-conversion of input frequency, attenuation can be added to or subtracted from the test channel at the one stable frequency. This more accurate technique of attenuation is called *IF-substitution*. It is used during calibration and permits the user to expand the output display resolution to ensure greater accuracy during the measurement. On the front panel of the 8410A Network Analyzer (No. 2, Figure 2-3) there are two test channel gain switches that are calibrated in units of ten dB and one dB. This IF-substitution extends the measurement range of the network analyzer for measuring values of attenuation greater than 60 dB.

¹For a more detailed explanation of these circuits, refer to "Microwave Theory and Applications," by Stephen Adam, pp. 418-421.

OUTPUT DISPLAY UNITS

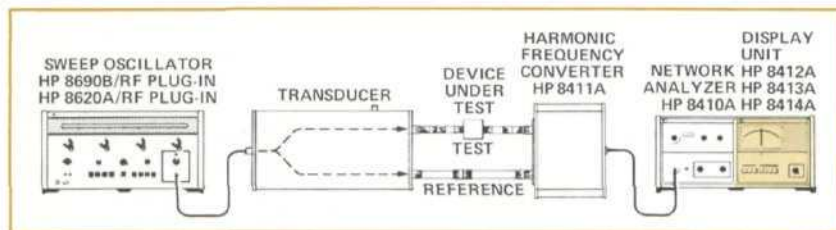

There are three plug-in display devices available. These units give the user a choice of convenient and varied read-outs of the processed information. In addition, peripheral equipment, such as an oscilloscope or X-Y recorder, can be tied into the system.

a. The Phase-Magnitude Display (HP 8412A)



Figure 2-5. The Phase-Magnitude Display Plug-In

This unit displays amplitude and phase versus frequency; i.e., insertion gain or loss or return loss can be displayed directly. It has 80 dB and ± 180 degrees display range with selectable resolutions up to 0.25 dB and 1 degree per major division, allowing measurement resolution of 0.05 dB and 0.2 degree using the inter-division graticule lines. Its dual channel scope allows amplitude and phase to be displayed either simultaneously or separately. Figure 2-6 illustrates this output display as used in an actual application.

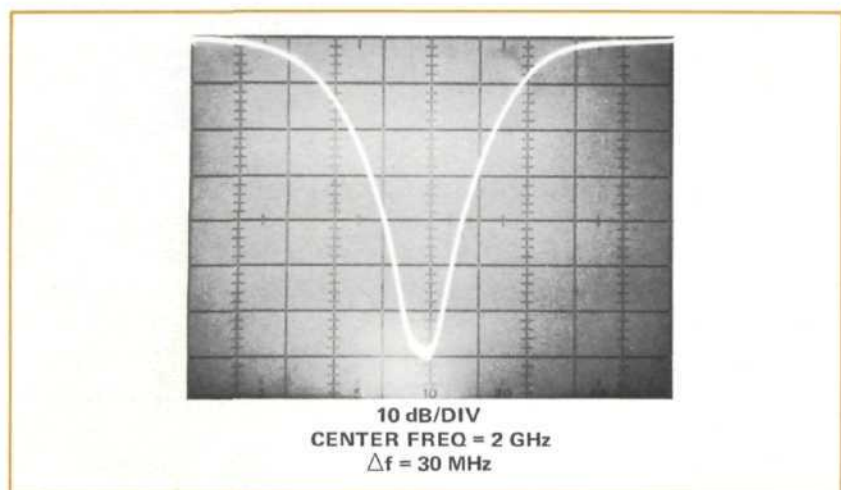

Figure 2-6. Test Results using the 8412A in a Transmission Measurement of an HP 8739A Notch Filter

b. The Phase-Gain Indicator (HP 8413A)

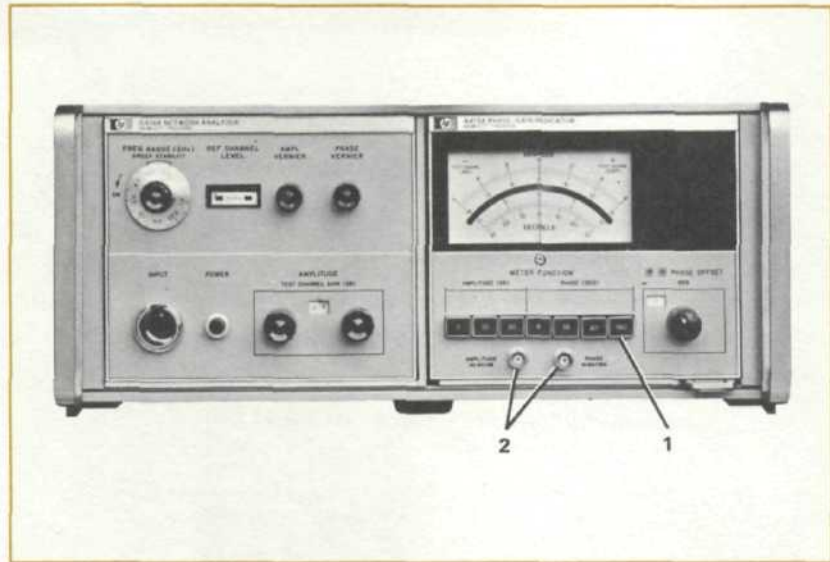

Figure 2-7. The Phase-Gain Indicator Plug-In

This unit uses a meter read-out for both phase and gain. The amplitude ranges are ± 30 dB, ± 10 dB, and ± 3 dB full scale, and phase ranges of ± 180 degrees, ± 60 degrees, ± 6 degrees full scale. Resolution of phase and amplitude measurements is selected at the front panel by pushbutton controls (No. 1, Figure 2-7). This permits CW tests to be made accurately. Two output connectors on the front panel (No. 2, Figure 2-7) provide phase and amplitude signals for an external recorder or dual channel oscilloscope for simultaneous swept measurements.

c. The Polar Display (HP 8414A)



Figure 2-8. The Polar Display Plug-In

The Polar Display provides a polar plot of the magnitude and phase of transmission and reflection coefficients, and can be used with either CW or swept frequency.

OUTPUT INTERPRETATION OF POLAR DISPLAY

If the device under test is a 50-ohm, well-matched device, the CRT will display a dot at the center of the screen. If the device is mismatched from the 50-ohm transmission line impedance then at each frequency, the device has a reflection coefficient, magnitude and phase that can be read off the display. If all energy is reflected, the reflection coefficient is equal to 1. Figure 2-9 illustrates this output display as used in an actual application. Each point on the CRT trace: 1) corresponds to a specific frequency; and 2) represents a value of reflection coefficient magnitude and a specific phase angle. The magnitude of the reflection coefficient of the device under test may be read on the concentric circles, using the scale: reflection coefficient = 0.2/division, beginning with zero at the center and 1.0 at the outer circle.²

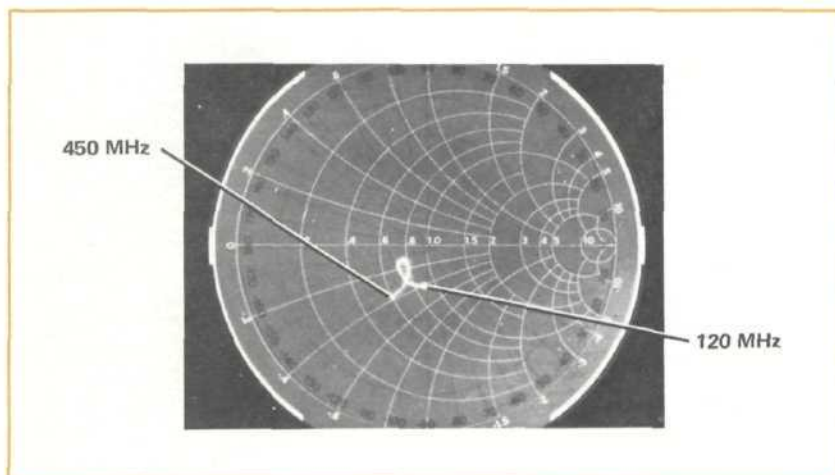

Figure 2-9. Test Result Using the 8414A in a Reflection Measurement.

The phase angle of each point may be read in degrees by noting where the radial line that passes through the point intersects the outside ring of the graticule.

Due to the relation between the reflection coefficient and impedance developed in Chapter 1, or

$$\Gamma = \frac{Z_{IN} - Z_O}{Z_{IN} + Z_O} \quad \text{AND} \quad \frac{Z_{IN}}{Z_O} = \frac{1 + \Gamma}{1 - \Gamma}$$

the Polar Display serves the dual purpose of displaying reflection coefficients and impedance with a Smith Chart overlay provided with each unit. Figure 2-10 illustrates this for one particular frequency where the complex reflection coefficient of $0.4/45^\circ$ is equivalent to a normalized impedance of $1.70/33.98^\circ$, or $1.41 + j0.952$.

² This scale can be expanded for better resolution by setting the TEST CHANNEL GAIN controls to a higher value. The scale can also be compressed, for negative impedance measurements, by setting these same controls to a lower value. For example, adding 14 dB of test channel gain will give a full scale value of 0.2, while subtracting 10 dB of gain will give a full scale value of 3.16. Expanded or compressed Smith Chart overlays are supplied for these full scale values.

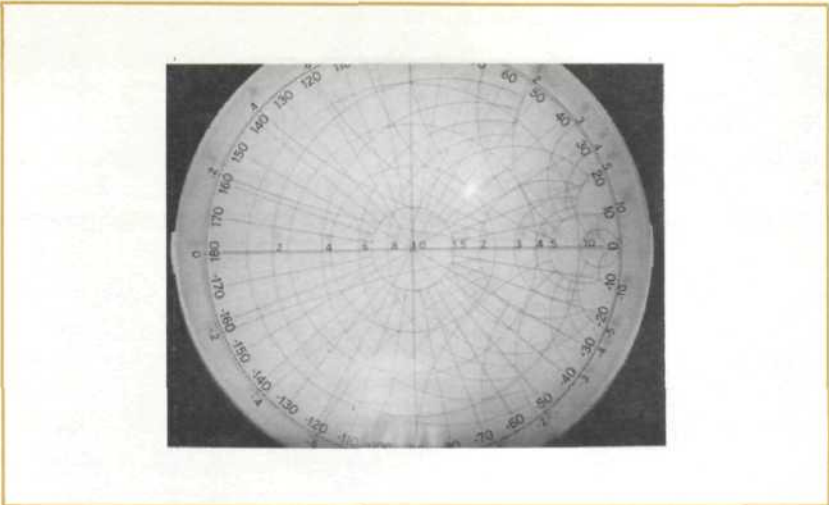
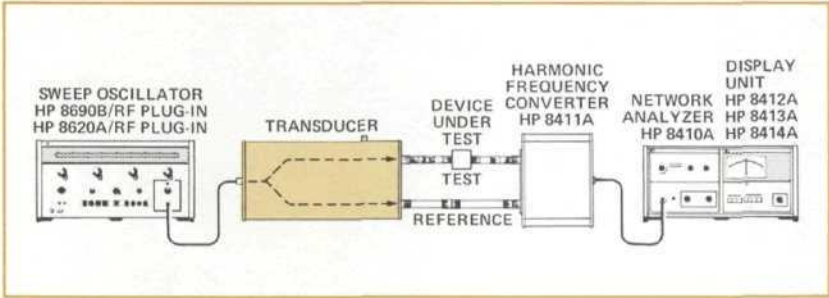

Figure 2-10. Polar Display for Measuring Complex Reflection Coefficients or Impedance with Smith Chart Overlay

$$\Gamma = 0.4/45^\circ \text{ or } \frac{Z_{IN}}{Z_{OUT}} = 1.41 + j0.952$$

THE TRANSDUCER



Transducer used in a Transmission Measurement

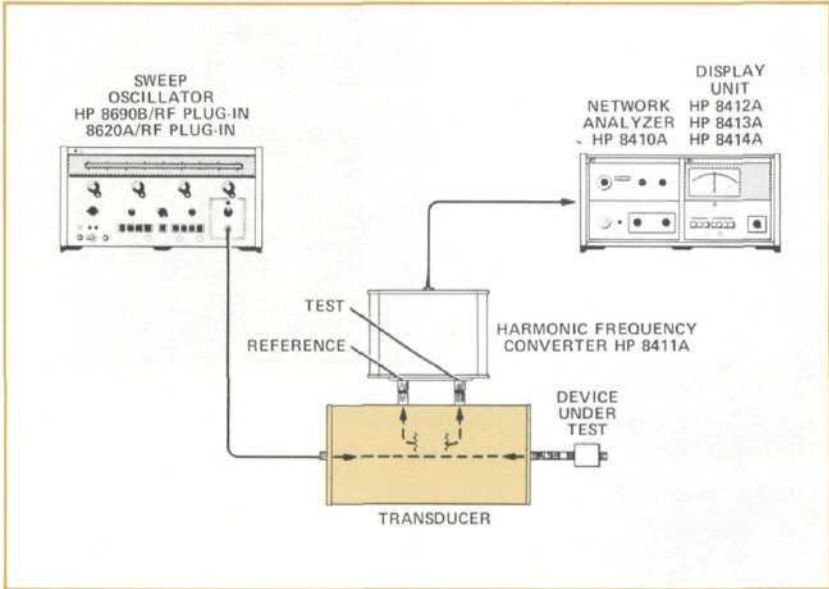

Transducer used in a Reflection Measurement

The transducer unit, placed as it is between the signal source and the harmonic frequency converter, has three functions. First, it has to split the incoming signal into a reference and a test channel. Secondly, it has to provide the capability of extending the electrical length of the reference channel so that the distances that the reference and test signals travel are equal. Thirdly, it connects the system correctly for transmission or reflection measurements.

a. Operation

To split the incoming signals into the reference and test channels, two basic methods are used: the power splitter, used in the 8740A Transmission Test Set, and directional and dual-directional couplers used in the other transmission and/or reflection units. Figures 2-11 and 2-12 illustrate these types of power dividers.

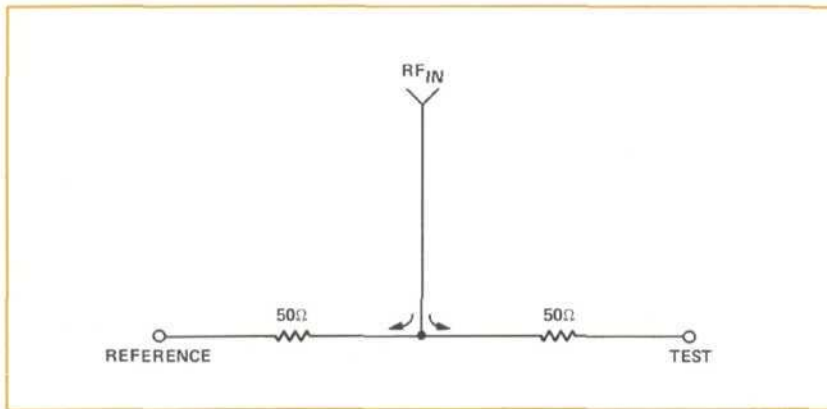

Figure 2-11. Power Splitter

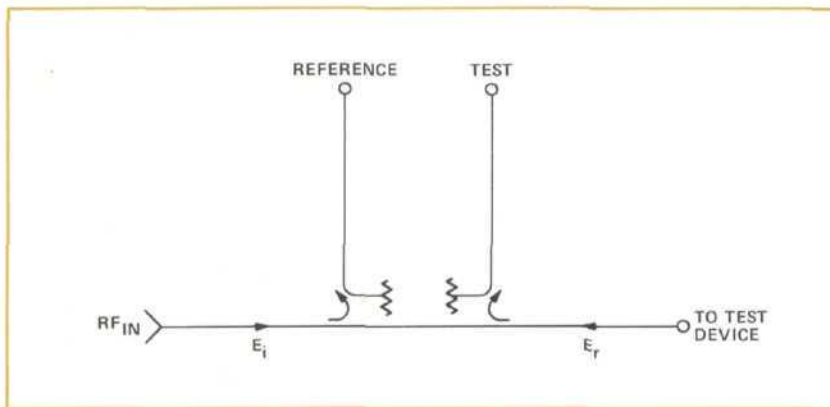

Figure 2-12. Dual Directional Coupler

To be effective and accurate, the directional couplers must have high directivity, or effective rejection of unwanted signals, determined by the ratio, in dB, of:

The power appearing at the auxiliary port when the coupler is in the forward direction to the power appearing at the auxiliary port when the coupler is in the reverse direction and the main arm terminated in a perfect load.

Figure 2-13 illustrates this definition:

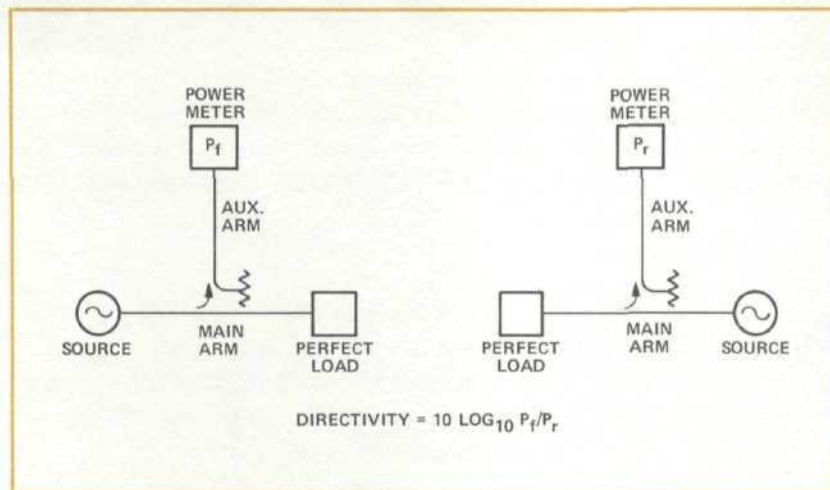

Figure 2-13. Illustration of Directivity Definition

b. Description of the Transducer Units

The transducers available are designed for transmission and/or reflection measurements in a variety of frequency ranges. Table I lists these transducers according to function and frequency range.

The evolution of these transducers has been from the more specialized to the more versatile.

The *Transmission Test Unit, 8740A*, operates over the entire frequency range of the network analyzer (0.11–12.4 GHz). When this unit is used, the device under test is inserted in the test channel between the transducer and the harmonic frequency converter while the reference channel of the transducer is connected directly, or through air line lengths, to the harmonic frequency converter. Since the device under test may vary in length, both electrically and physically, the reference channel can be extended both by means of a reference plane extension as well as by mechanical line extensions built into the Transmission Test Unit.

The *Reflection Test Units, 8741A and 8742A*, cover the frequency ranges of 0.11–2 GHz and 2–12.4 GHz, respectively. In these units, dual directional couplers are used in a reflectometer arrangement as shown above. One directional coupler couples a reference signal from the main signal path, rejecting the reflected signal from the unit under test. Another directional coupler couples the signal reflected from the unit under test but rejects the excitation signal. A line stretcher and reference plane extension, built into these units, are used to equalize the electrical paths of the reference and test signals.

The measurement of waveguide devices in the X- and P-bands requires special transducers, the X8747A and P8747A. These are discussed in Chapter VII.

The more versatile transducers, *Reflection/Transmission Test Set (8743A)* and *S-Parameter Test Set (8745A)* are capable of both transmission *and* reflection measurements. These transducers use directional couplers for splitting the incoming signal into the two channels. The device under test is connected to these transducers and then coaxial switches, operated by front panel pushbuttons, route the signals for reflection or transmission measurements. Chapters IV and V contain more detailed explanations of these units.

Table 1

		SWEEP OSCILLATOR			TRANSDUCER		HARMONIC FREQ CONVERTER		DISPLAY UNIT	
FREQUENCY RANGE	RF PLUG-IN								OUTPUT DISPLAY	
0.11 - 2 GHz	HP 8699B	HP 8740A	HP 8745A	HP 8741A					HP 8412A PHASE-MAG	
8 - 12.4 GHz	HP 8694B		HP X8747A						HP 8413A METER READ OUT	
2 - 12.4 GHz	HP 8699B TO 4 GHz								HP 8414A POLAR DISPLAY	
	HP 8693A 4-8 GHz	HP 8740A	HP 8743A	HP 8742A						
	HP 8694B 8-12.4 GHz									
12.4 - 18 GHz	HP 8695A		HP P8747A							
FUNCTION		TRANSMISSION ONLY	TRANSMISSION AND REFLECTION	REFLECTION ONLY						

SUMMARY

The units of the network analyzer system that have been described in this chapter can be assembled in many combinations that will provide the user with a measuring system fitted for his particular applications and frequency range of interest. These units have been assembled in three primary systems, capable of both reflection and transmission measurements, according to frequency range. Figures 2-14 and 2-16 show these systems.³

³The block diagrams for the components of the system will be found in Appendix II.

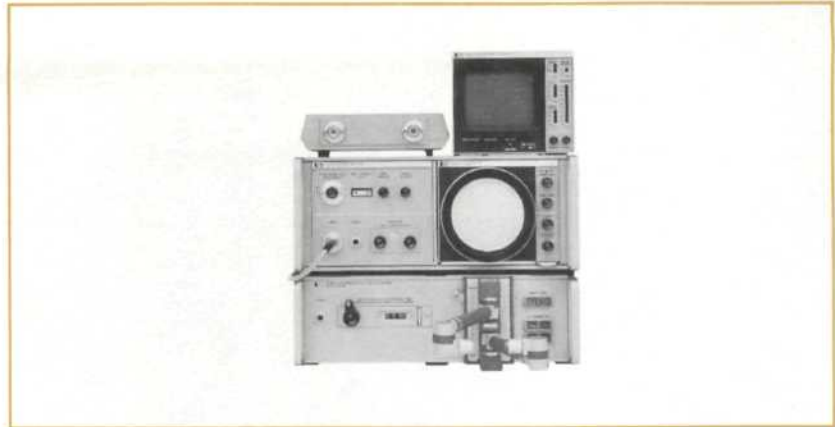

Figure 2-14. HP 8410S Option 110
0.11 – 2 GHz



Figure 2-15. HP 8410S Option 210
2 – 12.4 GHz



Figure 2-16. HP 8410S Option 310
0.11 – 12.4 GHz

CHAPTER III

GENERAL APPLICATION PROCEDURES

INTRODUCTION

At this point, the reader has a general understanding of the HP 8410A Network Analyzer system and the basic theoretical concepts upon which the system has been built.

Beginning with this chapter, we wish to explore the system's potential to see how its advantages of wide dynamic range, high resolution, and flexibility can actually be utilized in the lab or on the production line for a variety of applications.

This chapter is devoted to those procedures which are common to each system configuration and each type of measurement. These procedures must be followed carefully to ensure accurate and repeatable measurements when using any particular system configuration.

The division of the following chapters according to transducer (and thus frequency range) will assist the reader of the Application Note. This division, while not the only possible one, was selected since the transducers cover specific frequency ranges and are oriented to types of measurements. Within these chapters will be found specific calibration procedures as well as a variety of detailed application procedures that will assist the user in developing an operational knowledge of this particular system configuration.

It is obvious that not all possible applications, nor even all possible combinations of equipment, are included in these chapters. Sufficient applications are discussed in detail to ensure those using the equipment that they can operate the 8410A system at maximum efficiency. Once this operational knowledge has been obtained, the creativity of the engineer will lead him to further applications.

PRE-MEASUREMENT PROCEDURE

To achieve the specified accuracy of the 8410A Network Analyzer system requires that the equipment be set up correctly and calibrated prior to every measurement. The following procedures describe this pre-measurement procedure that is common to each system configuration.¹

¹As a convenience to the user of this Application Note, these procedures have been reproduced on a foldout in Appendix IV.

SETUP

1. Prior to any measurement, the frequency range *and* the type of measurement must be determined. Once these decisions have been made, the actual system configuration – the RF plug-in for the sweep oscillator, the transducer and the display unit – can be selected.
2. Select the appropriate transducer (refer to Table I of Chapter II).
3. Select the type of display desired:
 - a. Simultaneous swept displays of phase and magnitude on a CRT – Phase-Magnitude Display (HP 8412A).
 - b. Single frequency display of phase and magnitude on a meter or simultaneous swept displays of phase and magnitude on an external oscilloscope or X-Y recorder – Phase-Gain Indicator (HP 8413A)
 - c. CW or swept-frequency polar display of phase and magnitude for reflection/transmission coefficient (convertible to impedance with CRT Smith Chart overlay) – Polar Display (HP 8414A).

CONNECTIONS (Figure 3-1)

1. RF power from the sweep oscillator to the transducer.
2. Blanking and marker terminals of sweep oscillator to display unit or auxiliary oscilloscope if desired. The function of blanking is to blank out the re-trace on the oscilloscope. The function of the markers is to identify frequency by trace brightening.
3. The sweep reference terminal of sweep oscillator to the 8410A mainframe. The function of the sweep reference is to increase the phase lock capability at high sweep rates. Refer to the Figure 1-5 on page xiii, which shown connections between the 8620C and 8410B.
4. For the 8412A Phase-Magnitude display unit or the 8413A with an auxiliary oscilloscope, the sweep-out terminal of the sweep oscillator must be connected to the sweep-in terminal of the display unit or oscilloscope.
5. The 8411A connected with APC-7² connectors to the transducer.
6. All units plugged into ac power.

²Important recommendations about the handling and care of APC-7 connectors are given in Appendix III.

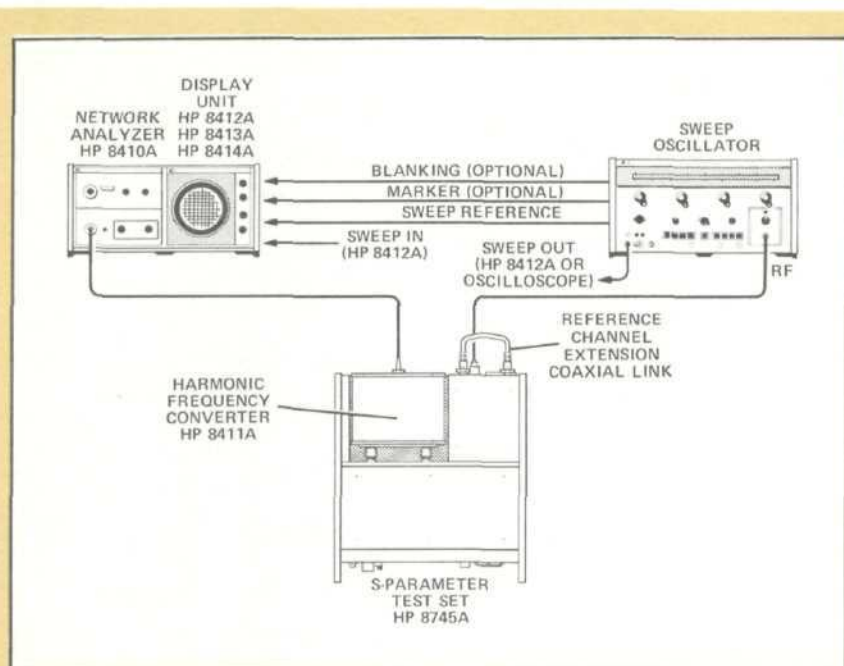
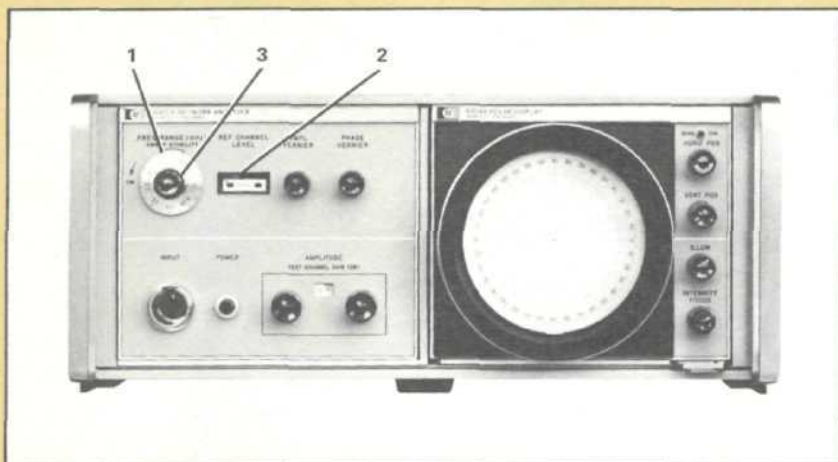
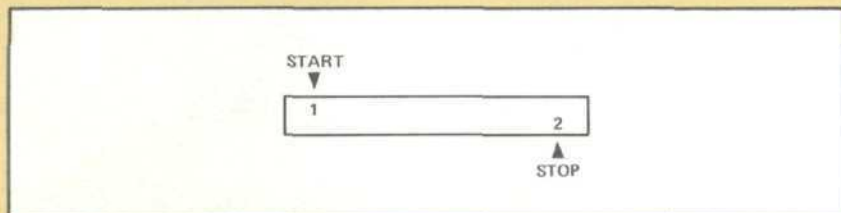

Figure 3-1. Cable Connections When Using the 8745A

TEST PHASE-LOCK AND REFERENCE CHANNEL POWER LEVEL



1. Set source to frequency sweep of interest (octave band if 8410A) and sweep speed of 0.01 sec.



2. Set the frequency range switch (No. 1 in above figure) to AUTO (if 8410B) or to the appropriate octave band (if 8410A) and leave the front panel connectors on the transducer open.

3. Adjust the sweep oscillator RF power level so that the reference channel power level (No. 2) (i.e., RF power into the 8411A Harmonic Frequency Converter reference channel) is in the "Operate" position of the scale. This ensures that there is enough power for phase-locking.
4. Observe the trace on the display unit.
 - a. Switch the sweep mode to automatic repetitive sweeping.
 - b. For the Phase-Magnitude Display (8412A), set the mode switch to "Amplitude." (Using the 8413A with an external oscilloscope accomplishes this same function.)
 - c. For the Polar-Display Unit (8414A), if a dot appears on the screen, change the reference plane extension (on transducer) until the dot extends out to a semi-circular trace. If no dot appears on the screen, adjust the test channel gain control until one appears. The normal initial setting for this control is around 21 dB.
5. Adjust the sweep stability red vernier control (No. 3) until the display trace is a solid line over the entire sweep. This ensures phase-locking over the entire frequency range. At times, better phase locking can be achieved by setting the 8410A's frequency range switch on either side of the exact range. Figures 3-2 and 3-3 illustrate improper and proper phase locking traces.

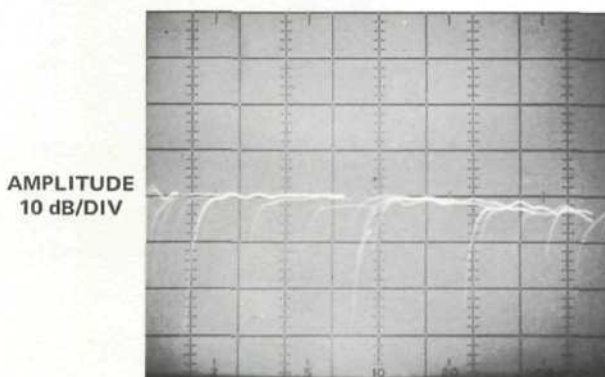

Figure 3-2. Improper Phase Lock

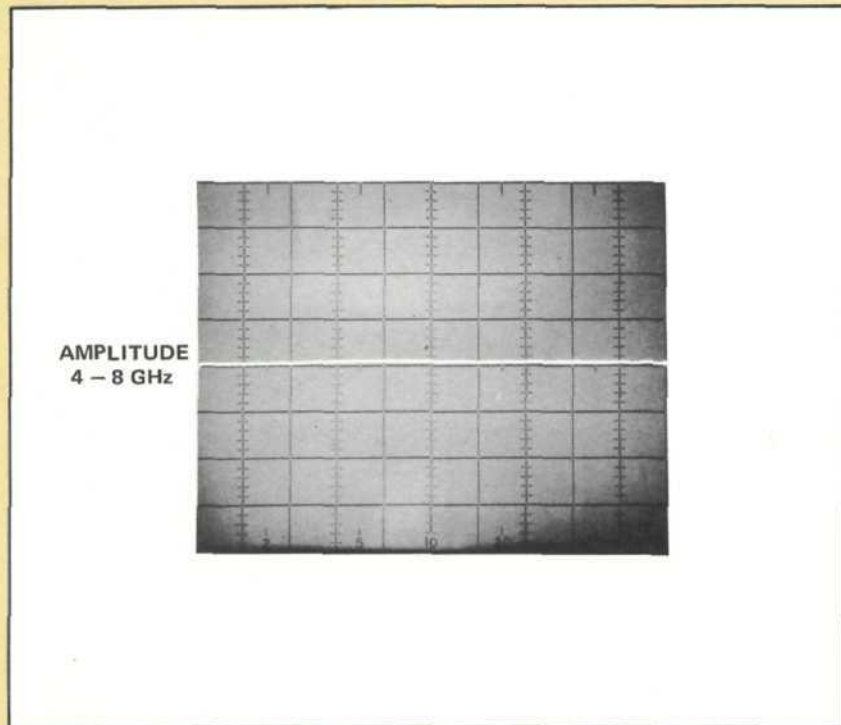
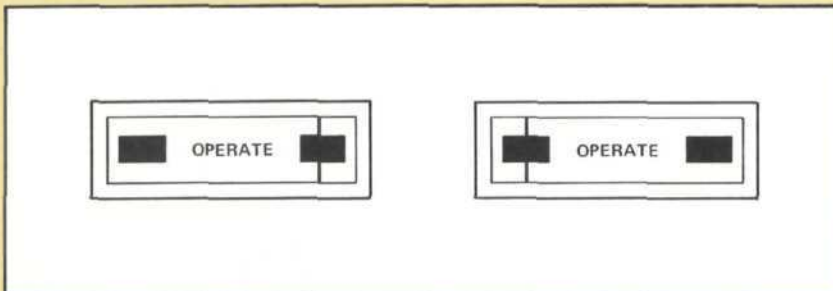

Figure 3-3. Proper Phase Lock

6. Switch sweep selector to manual and manually sweep over the frequency range to ensure that the reference channel power level remains in the "Operate" portion over the entire range. If the needle on this meter moves into the right black portion



during this test, reduce power from the sweeper. If the needle moves into the left black portion, this could indicate that the system is dropping out of phase lock. Increase RF power or readjust sweep stability control.

POWER CONSIDERATIONS

In addition to the procedures required prior to any measurement, three further specifications of the system need to be considered. These refer to the power levels in the reference and test channels.

These power level considerations are applicable for any attenuation or gain measurements using any system configuration when the wide dynamic range capability of the system is utilized.

Specifications of interest:

1. *Reference Channel Power Level* (measuring the RF power level into the harmonic frequency converter) must be between -16 and -44 dBm.
2. *Test Channel Power Level*: -10 dBm to the system noise level (-78 dBm or lower).
3. The *Test Channel* cannot be greater than 20 dB over the *Reference Channel*; i.e., if the reference channel power level is -40 dBm, the test channel power level must be -20 dBm or less.

Attenuation Measurements

Since the network analyzer is essentially a ratiometer, measuring the ratio between the reference and test signals, we see that if both the reference and test channels are initially at the same power level, e.g., -30 dBm (mid-range of the reference channel operating range), then the maximum measuring window for the test channel is 48 dB; i.e., -30 dBm to the noise level of the system, -78 dBm. However, the test channel can be offset from the reference channel by padding the RF inputs to the harmonic frequency converter, 8411A, as in Figure 3-4.

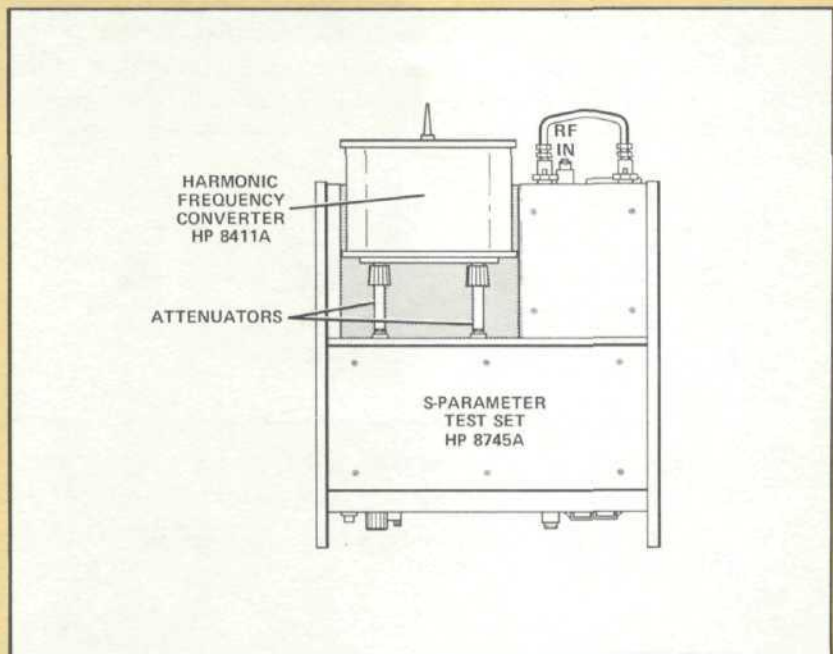

Figure 3-4. Power Level Offset Setup

For maximum dynamic range we would like the test channel to be offset so that the input power level is approximately -10 dBm with the reference channel operating at mid-range or -30 dBm.³

³Without offsetting, both channels operate at the same power levels.

To accomplish this, insert a 20-dB attenuator in the reference channel and a 3-dB attenuator in the test channel.⁴ These pads are inserted prior to calibration.

Figure 3-5 illustrates the operating power levels in these channels for attenuation measurements.

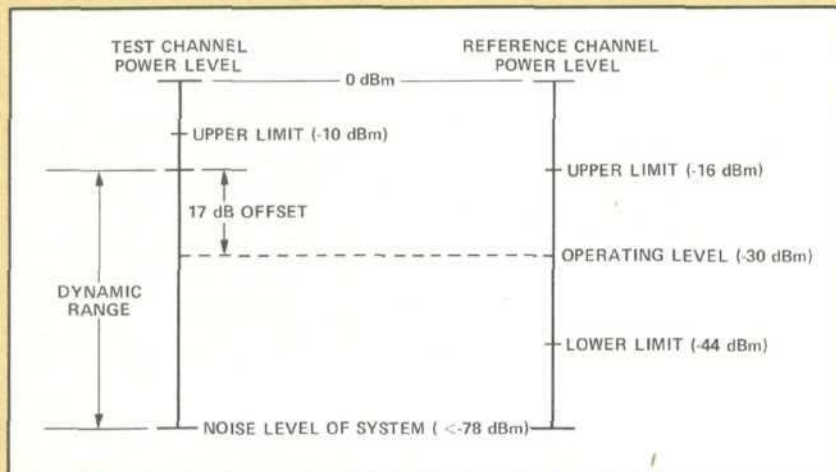

Figure 3-5. Power Levels for Attenuation Measurements

Gain Measurements

When measuring the forward gain of an amplifier, i.e., the S_{21} parameter, the limiting specification is the upper power level, -10 dBm, of the test channel.

To expand the dynamic range, we again offset the reference and test channels but in the opposite direction from the above discussion. Thus, by placing a 30-dB attenuator in the test channel and a 3-dB attenuator in the reference channel while operating at -30 dBm in the reference channel, the dynamic range is now 47 dB (-57 dB to -10 dB). This can be seen in Figure 3-6.

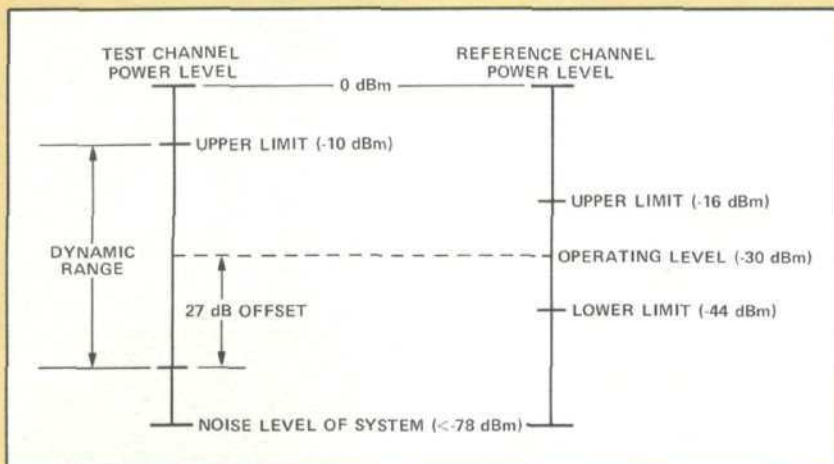

Figure 3-6. Power Levels for Gain Measurements

⁴Both channels are padded due to the mechanical problem of attaching the 8411A to the transducer.

In summary, the following four points must be remembered concerning dynamic range of transmission measurements.

1. Test channel power level must *not* be greater than 20 dB above the reference channel power level.
2. The reference channel power level should be as *low* as possible to reduce errors due to interchannel crosstalk while still *high* enough to reliably achieve phase-lock.
3. The maximum power levels must not be exceeded:

Reference Channel: -16 dBm

Test Channel: -10 dBm

4. Noise level in the test channel is ≤ -78 dBm.

CHAPTER IV

HP 8745A TRANSDUCER APPLICATIONS (0.11 – 2.0 GHz)

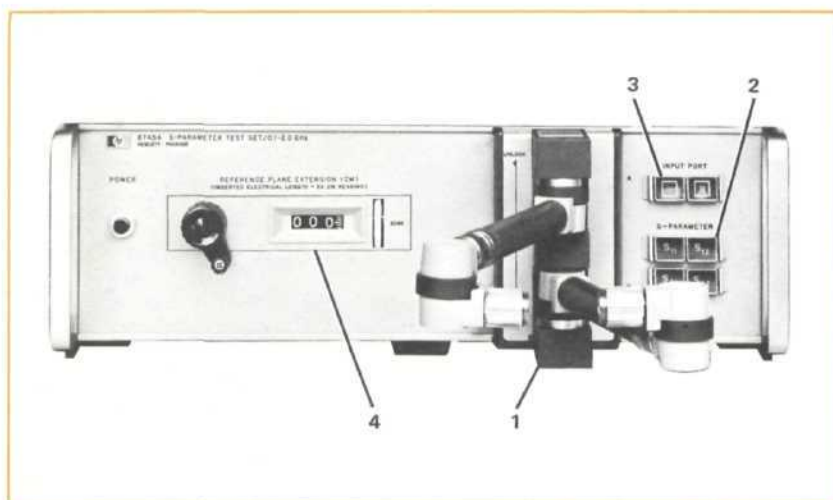

Figure 4-1. The HP 8745A S-Parameter Test Set

INTRODUCTION

The 8745A S-Parameter Test Set provides the necessary system configuration for measuring the S-parameters of any device when used with the 8410A Network Analyzer System.¹ It operates over the frequency range of 0.11 to 2.0 GHz and is programmable for automatic usage. Peripheral equipment such as the Universal Extension (HP 11604A) (No. 1, Figure 4-1) and Transistor Fixtures (HP 11600B/11602B) make this test set very flexible. With this transducer in the system, all four S parameters of 2-port devices, discussed in Chapter II, can be measured by using the four push-buttons on the front panel (No. 2, Figure 4-1). This pushbutton ease of measurement is accomplished by means of coax switches which actually orient the RF source, load and directional couplers, depending on the S parameter being measured. The following figures show the actual setups for measuring these parameters.

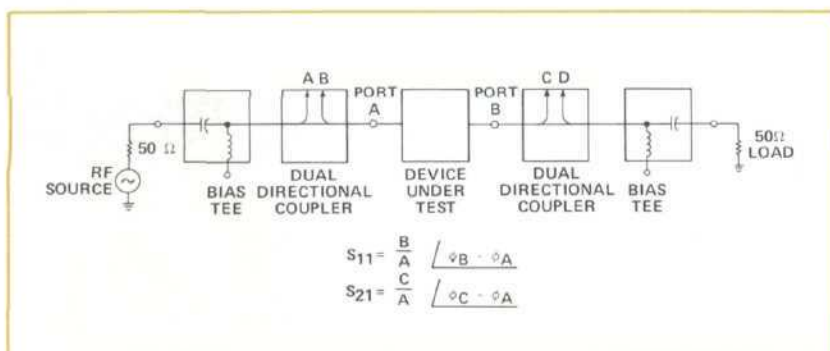

Figure 4-2. Setup for Measuring S_{11} and S_{21}

¹Chapter VI describes the measurement of semiconductors with the 8745A.

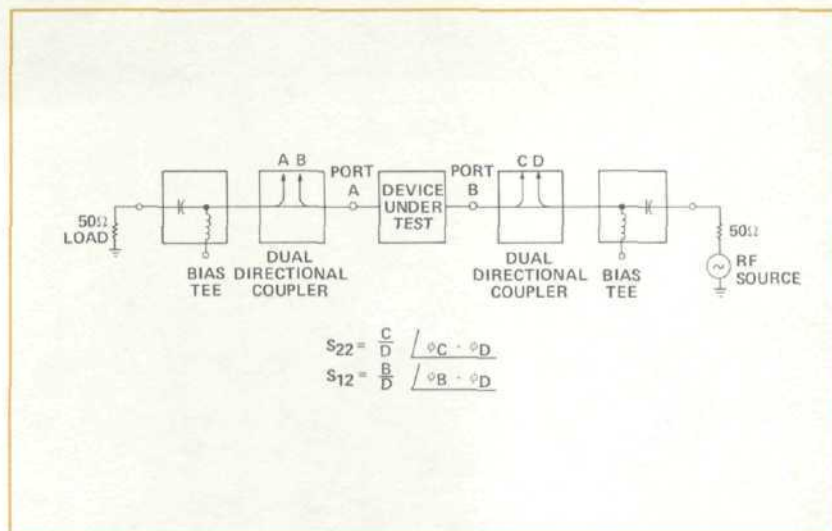

Figure 4-3. Setup for Measuring S_{22} and S_{12}

Once the system is calibrated and the device to be tested is inserted in the Universal Extension (11604A) (No. 1, Figure 4-1), no further change in test setup needs to be made to measure all S parameters.

The bias tees are included for the measurement of semiconductors (described in Chapter VI). They allow dc bias to be applied to the device under test.

A point of confusion sometimes arises as to the meaning of the input port switches (No. 3, Figure 4-1). Since S_{11} and S_{21} are the reflection and transmission coefficients looking into the input port of the device, these input port pushbuttons actually determine which port of the device is being driven. To select the proper input port, the operator must determine which port of the device under test is to be considered the input port. He then presses the input port pushbutton which corresponds to the 8745A port which is connected to the input port of the device under test.

For example, pressing button "A" means the incident test signal is applied to port A of the 8745A. As a result, power is delivered to the test device from port A when measuring S_{11} and S_{21} , and from port B when measuring S_{22} and S_{12} . For some devices it doesn't matter which port is input or output, but when measuring semiconductor characteristics, the capability of changing input ports is necessary if the transistor is to be characterized in the common emitter, base and collector configurations.

The Reference Plane Extension (No. 4, Figure 4-1), together with the fixed rear panel reference extension (No. 1, Figure 4-8) are used to equalize the path lengths of the reference and test signals. Figure 4-4 illustrates the reference and test channel path lengths for reflection calibration.

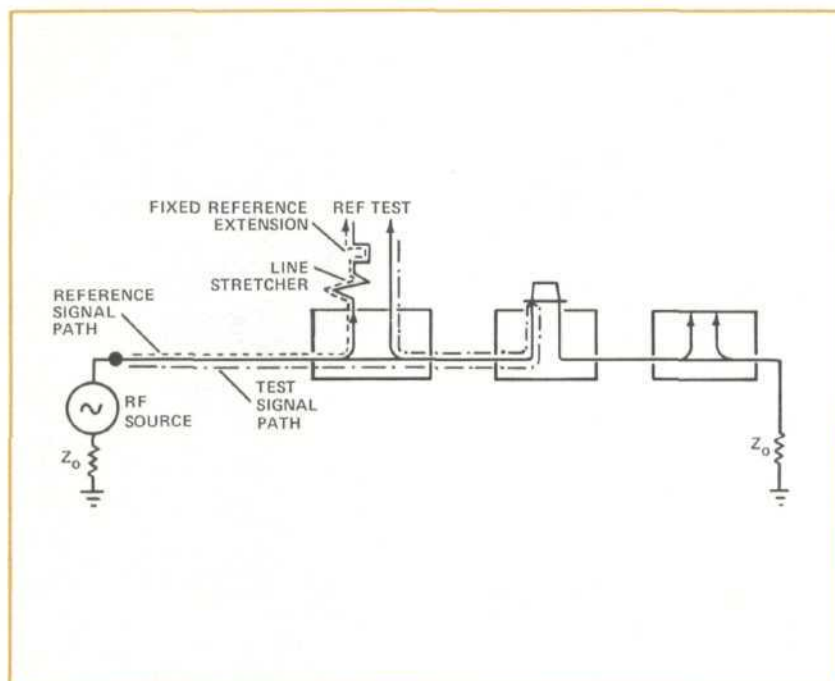

Figure 4-4. Reference and Test Channel Path Lengths

When making measurements with the Universal Extension (11604A), it is necessary to use the long* coaxial link supplied with the universal extension to compensate for the electrical length of the device under test and the universal extension. A short coaxial link is supplied with the S-Parameter Test Set.

CALIBRATION

The procedure followed in calibrating the system for reflection and transmission measurements will now be described in detail. It is important that this procedure be followed to ensure proper operation of the system.

When calibrating the system prior to any measurement, be sure to make the calibration using all connections and adapters that will be necessary in the measurement itself; e.g., APC-7 to Type N adapters. This is necessary to ensure that any loss or phase shift introduced by these adapters will be compensated for in the calibration. This precaution applies to any type of measurement and/or calibration described in this chapter.

REFLECTION CALIBRATION

1. **Set Up Equipment.** Follow the procedural methods discussed in Chapter III.²

*HP Part Number 11604-20021.

²Use the Pre-Test Procedure foldout in Appendix IV to facilitate your calibration.

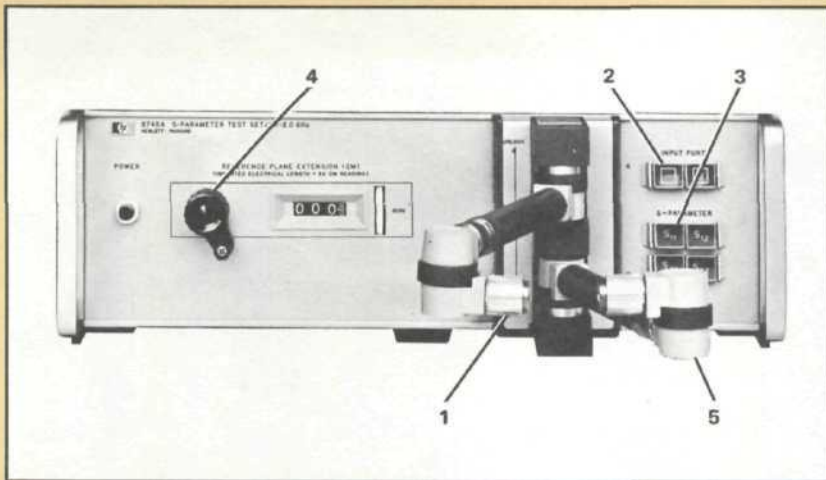

- a. Connect a short to Arm A (No. 1) of the 11604A.
- b. Depress "A" Input Port (No. 2) and S_{11} switches (No. 3).

2. Typical Results on Two Display Units.

Phase-Magnitude Display—8412A³

Polar Display—8414A

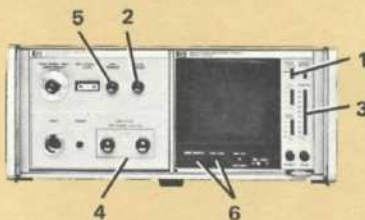

- a. Select Phase mode (No. 1) at $90^\circ/\text{div}$. Adjust horizontal controls (No. 6) for sweep linearity.
- a. Holding beam center switch (No. 1) depressed, adjust vertical and horizontal position (No. 2) until beam is centered on display. Release switch.
- b. Adjust reference plane extension on 8745A (No. 4) for:

Flat Horizontal Line

Dot or Smallest Cluster

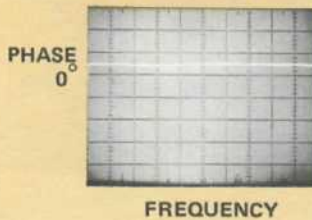

This indicates that the electrical lengths in the incident and reflected channels of the reflectometer are equal.

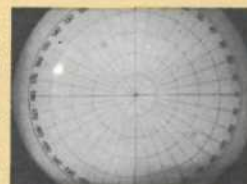

REFLECTION COEFFICIENT

Set degree offset switch on 8412A (No. 3) to 180° .

³The identical results shown for the 8412A could be obtained with the 8413A and an oscilloscope.

- c. Adjust 8410A (No. 2) phase vernier for:

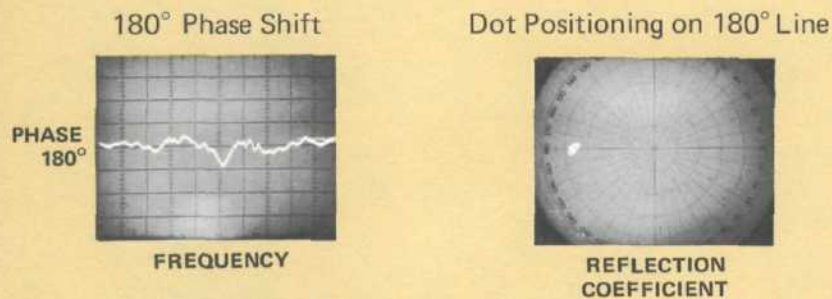

Increase resolution to 1°/div
for this step.

- d. Adjust 8410A test channel gain (No. 4) and amplitude vernier (No. 5) for:

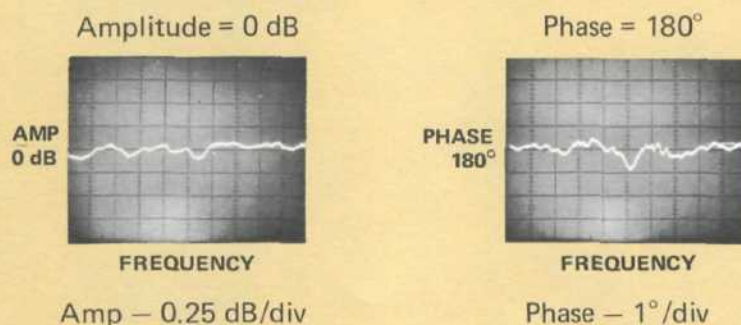

(Select Dual mode)

$$\rho = 1.0$$

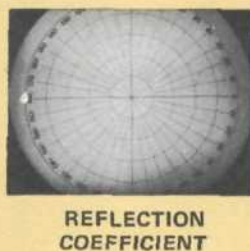

These adjustments are made to calibrate the displays using a short. The Polar Display must show a reflection coefficient of $S_{11} = 1/180^\circ$, and the Phase-Magnitude Display a return loss of 0 dB and 180°.

- e. Connect the short to Arm B (No. 5) of the 11604A and depress S_{22} switch. The results will be nearly the same as before when measuring S_{11} from Port A.

The fact that S_{11} and S_{22} are nearly identical means the couplers in the 8745A track well. This means accuracy and time saving since it is not usually necessary to calibrate separately for S_{11} and S_{22} except for the most precise measurements.

TRANSMISSION CALIBRATION

1. **Set Up Equipment.** Follow the procedural methods discussed in Chapter III.

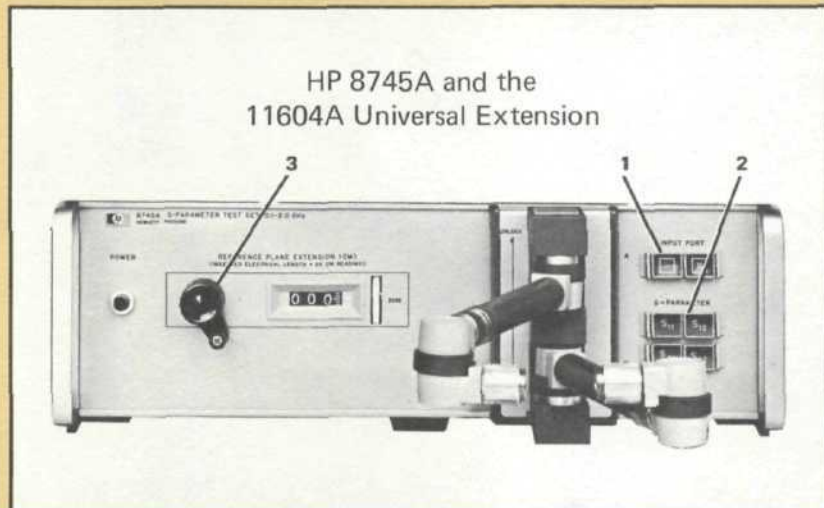

- a. Connect the arms together and depress the A-Port (No. 1) and S_{12} or S_{21} switches (No. 2)

2. **Typical Results on Two Display Units**

Phase-Magnitude Display
HP 8412A

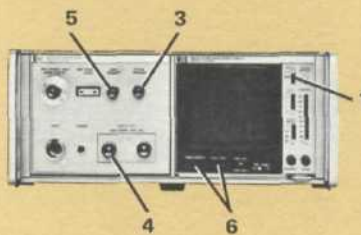

- a. Select Phase mode (No. 1) at $90^\circ/\text{div}$. Adjust horizontal controls (No. 6) for sweep linearity.

Polar Display
HP 8414A

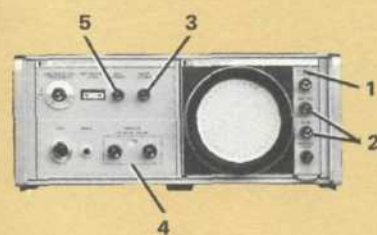

- a. Holding beam center switch (No. 1) depressed, adjust vertical and horizontal position (No. 2) until beam is centered on display. Release switch.

- b. Adjust Reference Plane Extension on 8745A (No. 3) for:

Flat Horizontal Line



FREQUENCY

Dot or Smallest Cluster



TRANSMISSION
COEFFICIENT

c. Adjust 8410A phase vernier (No. 3) for:

0° Phase Shift

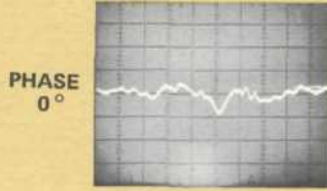

FREQUENCY

Dot Positioning on 0° Line

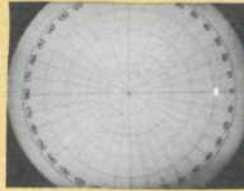

TRANSMISSION COEFFICIENT

Increase resolution to 1°/div.

d. Adjust 8410A test channel gain (No. 4) and amplitude vernier (No. 5) for:

Amplitude

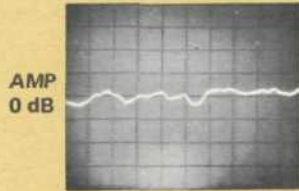

FREQUENCY

Amp - 0.25 dB/div

Phase



FREQUENCY

Phase - 1°/div

(Select Dual mode)

$$\tau = 1 / 0^\circ$$

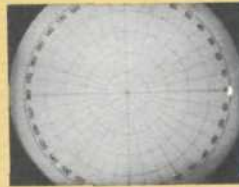

TRANSMISSION COEFFICIENT

These adjustments are made to calibrate the displays for a through circuit. The Polar Display must show a transmission coefficient or S_{12} or $S_{21} = 1.0/0^\circ$, and the Phase-Magnitude Display an insertion loss of 0 dB and 0° .

BENEFITS

1. Notice that the 8745A is in almost perfect calibration for transmission measurements even though it has been calibrated for reflection.
2. Notice how S_{21} and S_{12} are almost exactly the same. This means the couplers track well for S_{21} and S_{12} .
3. Only one simple, accurate calibration need be made for all four S parameters. When in a hurry, you can leave the universal extension open for lower frequencies and calibrate for S_{11} . If you need more accuracy, you can get it by calibrating separately for each S parameter.

The network analyzer system is now properly set up and calibrated for accurate use.

APPLICATIONS USING THE S-PARAMETER TEST SET (8745A)

GENERAL PROCEDURE

To measure the S parameters of a microwave hardware device, perform the following steps:

1. Set up (Figure 4-5) and calibrate the 8410A system as previously described in this chapter.
2. Insert the device to be tested between the arms of the Universal Extension (11604A), and select input port A or B as desired.
3. Select the S parameter to be measured.
4. If the 8414A Polar Display plug-in is used with the 8410A Network Analyzer, read the magnitude and phase from the CRT. For reflection measurements, S_{11} or S_{22} , insert a Smith Chart overlay on the face of the CRT and read input and output impedance directly.⁴ For transmission measurements, S_{12} or S_{21} , read the transmission coefficient directly from the CRT.
5. If the 8412A Phase-Magnitude plug-in is used for transmission measurements, read the magnitude and phase directly from the display. These quantities can be displayed together or separately.

The system accuracy is a function of the sources of error in the system. The sources of error included are IF gain control, meter accuracy (8413A), phase offset, system noise, crosstalk, and mismatch.

Accuracy curves, available in the 8410S Data Sheet, show overall system uncertainty, excluding mismatch, when measuring amplitude and phase.

⁴Refer to the discussion on "Output Interpretation for the 8414A" in Chapter II.

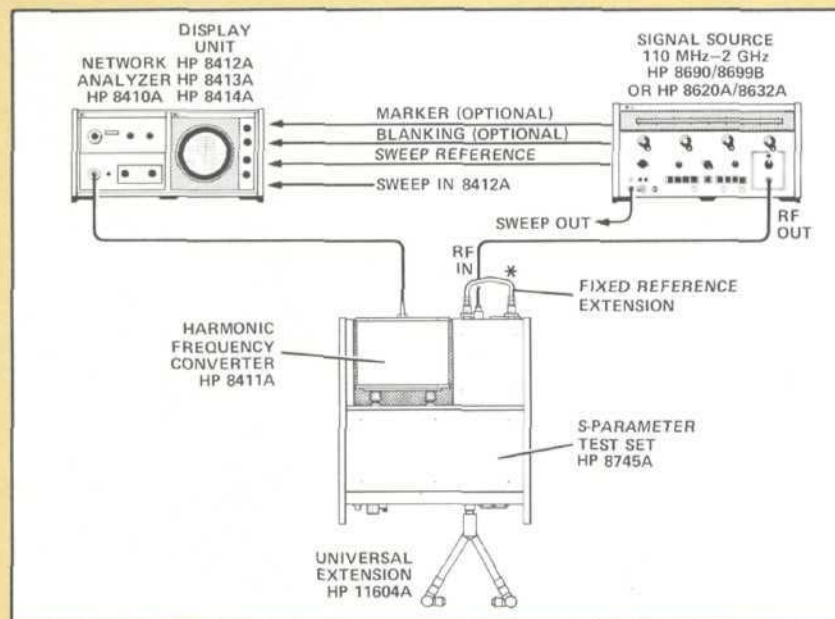

Figure 4-5. General Test Setup for Microwave Hardware Measurements Using the 8745A S-Parameter Test Set

*Rear-Panel Coaxial Link (HP Part No. 11604-20021)

TRANSMISSION MEASUREMENTS APPLICATIONS

ATTENUATION OF A NOTCH FILTER

The purpose of this measurement demonstration is to illustrate the basic 8745A test setup and the procedure for obtaining the 60+ dB of dynamic range of the system. The specification of the HP 8439A Notch Filter calls for a notch width of 2 MHz at 60 dB attenuation centered at 2 GHz.

Procedure

- Set up system as in Figure 4-5 using the Phase-Magnitude Display Unit.⁵
- Follow the calibration procedures described in this chapter. The filter to be tested has Type N connectors so adapters to the APC-7 connectors of the Universal Extension (11604A) must be used. Place 20 dB attenuator in reference channel and 3 dB attenuator in test channel before calibration to ensure maximum dynamic range.⁶
- With the start-stop sweep control on the sweep oscillator set to 1 to 2 GHz, press input Port A and S_{21} pushbuttons and note the notch near the right side of the CRT display, as in Figure 4-6.

⁵The Phase-Gain Indicator (8413A) with an oscilloscope could be used in this measurement.

⁶Refer to the "Power Considerations" section of Chapter III.

Test Results



Figure 4-6

Test Results

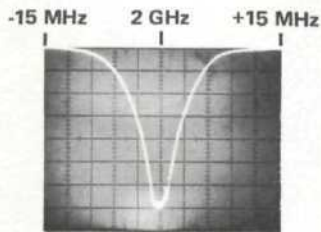

Figure 4-7.

- d. Change sweep mode to Δf on the sweep oscillator. Center sweep at the notch (2 GHz) and expand the output display by reducing the Δf frequency range to ± 15 MHz about the center frequency. Note that the dynamic range is 70 dB. (To obtain maximum dynamic range, reduce sweep speed to the 1–0.1 second range and select the 0.1 kHz Video Filter of the 8412A.)

INSERTION PHASE AND ATTENUATION OF A PIN MODULATOR (HP 8731A)

Purpose

The purpose of this measurement demonstration is to illustrate the capability of the system in making swept measurements of phase shift at various attenuation levels. This experiment will also demonstrate a variation in measurement procedure since linear phase shift will be cancelled out.

Procedure

- a. Set up system as in Figure 4-5 with the PIN-modulator bias setup as in Figure 4-8.

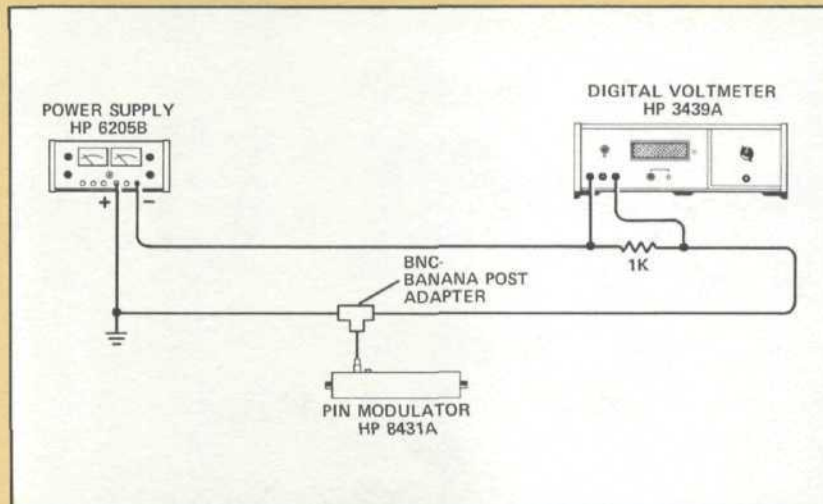

Figure 4-8. Test Setup for Biasing The Pin Modulator

- b. Insert the PIN modulator in the Universal Extension (11604A) after adding a 10 cm air line in one of the arms of the extension and support the modulator so its weight isn't being carried by the 11604A. (This additional air line is necessary whenever the test device is physically longer than the widest opening of the universal extension.)
- c. Insert two additional 20 cm air lines in the rear-panel coaxial link to compensate for the additional length added to the universal extension.
- d. Follow Pre-Test Procedure and calibration procedures.

- e. With the bias power supply off, calibrate the system. Set the mode switch of the 8412A to "phase". Adjust the 8745A reference plane extension and 8410A phase vernier until the end points of the phase response are on the same horizontal graticule line.
- f. Set the 8412A mode switch to amplitude. Adjust the 8410A test channel gain control and the amplitude vernier for zero dB level as a reference. Switch mode to phase and photograph the display. (Figure 4-9.)
- g. Turn on the power supply and adjust the voltage level until the amplitude display indicates 5 dB loss in the modulator. Then switch the mode switch of the 8412A to phase and photograph the phase response. (Multiple exposures are taken for this and the following attenuation measurements.)
- h. Repeat step g for several other attenuation levels. Figures 4-10 and 4-11 illustrate typical results.

As the bias level is increased (i.e., more attenuation introduced into the modulator), linear as well as non-linear phase shift is introduced. This linear phase shift may be eliminated for each attenuation level by adjusting the 8745A reference plane extension and adding lengths of air line to the rear panel coaxial link until the phase shift end points are on the same horizontal graticule line. Figure 4-12 illustrates a typical family of curves of non-linear phase shift vs. frequency for various attenuation levels after the linear phase shift has been eliminated.

HIGH RESOLUTION MEASUREMENTS OF TRANSISTOR AMPLIFIER GAIN

Purpose

The purpose of this section is to demonstrate several capabilities of the network analyzer:

- a. Measurement of gain.
- b. Use of IF substitution techniques.
- c. Use of X-Y recorder in conjunction with the system for making high resolution measurements using grid or calibration lines. This technique is useful in other applications requiring high resolution such as the measurement of insertion loss or passband ripple of filters.

Test Results



Figure 4-9

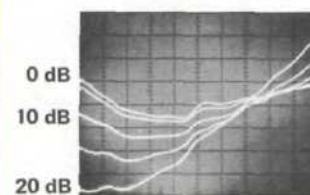

5°/DIV
SWEEP
0.9 - 1.8 GHz

Figure 4-10.

Typical Test Results

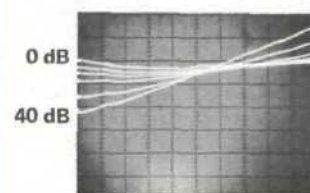

25°/DIV
SWEEP
0.1 - 1.8 GHz

Figure 4-11.

Typical Test Results

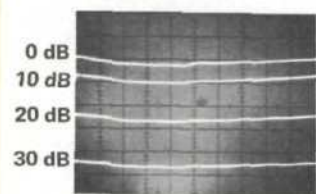

25°/DIV
SWEEP
0.9 - 1.8 GHz

Figure 4-12.
Typical Family
of Pin-Modulator
Non-Linear Phase Shift
vs Frequency

Pre-Test Procedure

1. Set up system as in Figure 4-13.

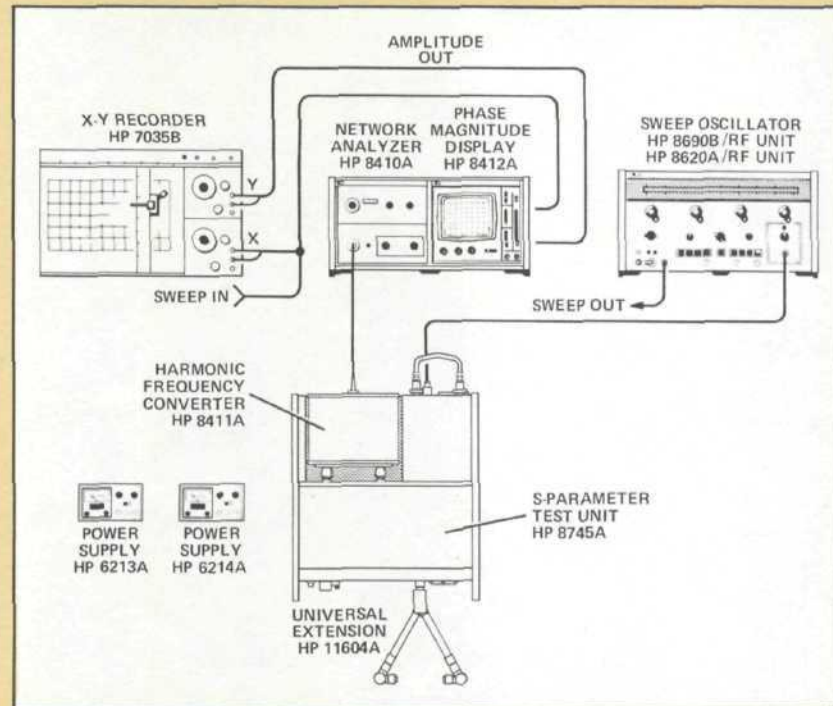

Figure 4-13. Test Setup for Measuring Amplifier Gain

The amplifier to be tested is an HP 35005A microcircuit amplifier with the following specifications:

FREQUENCY RANGE: 0.1 – 2.0 GHz
 GAIN: 40 dB
 GAIN FLATNESS: ± 3 dB
 MAXIMUM RF LEVEL:
 INPUT PORT: +4 dBm
 OUTPUT PORT: +16 dBm
 TYPICAL INPUT RF LEVEL: -25 to -30 dBm
 CONNECTORS: SMA

2. Input power level considerations: since the input power level to the amplifier is critical for the amplifier's proper operation, five factors must be considered:
 - a. Input power level to the amplifier must be between -25 and -30 dBm.
 - b. The reference channel operating range is -16 to -44 dBm but must be high enough for phase locking.
 - c. The maximum test channel power level is -10 dBm.
 - d. The power level of the test channel cannot be higher than 20 dB above the reference channel.

- e. The nominal gain of the amplifier is 40 dB. Figure 4-14 illustrates typical power levels for a transmission measurement calibration. (To understand the diagram and the power levels listed, start at the "Ref Output" terminal using the power level limits (-16 and -44 dBm) and then trace back through the circuit.)

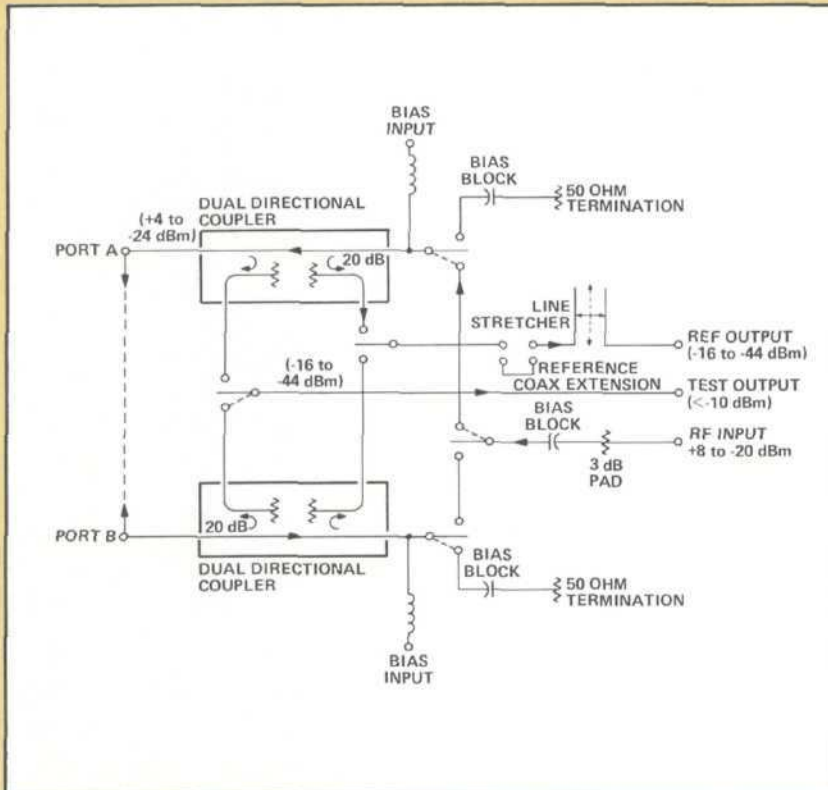

Figure 4-14. Simplified 8745A RF Schematic Diagram
Switches shown for Transmission Measurement.

As can be seen, the lowest power level to Port A is -24 dBm due to the constraints of the reference channel power level. Putting a 10 dB pad into the arms of the universal extension during calibration and test will lower the input power to the amplifier to the proper operating level, with the RF input approximately -15 dBm. Place a 3-dB pad in the reference channel and a 20-dB pad in the test channel.⁷

3. Calibration

- a. Insert the 10 dB attenuator in the Port A arm of the universal extension. Attach the APC-7 to SMA adapters to the attenuator and to the Port B arm and connect the SMA adapters.
- b. Follow the calibration procedures described earlier in this chapter. Record the test channel gain level.

⁷ Refer to the "Power Consideration" section of Chapter III.

Test Results

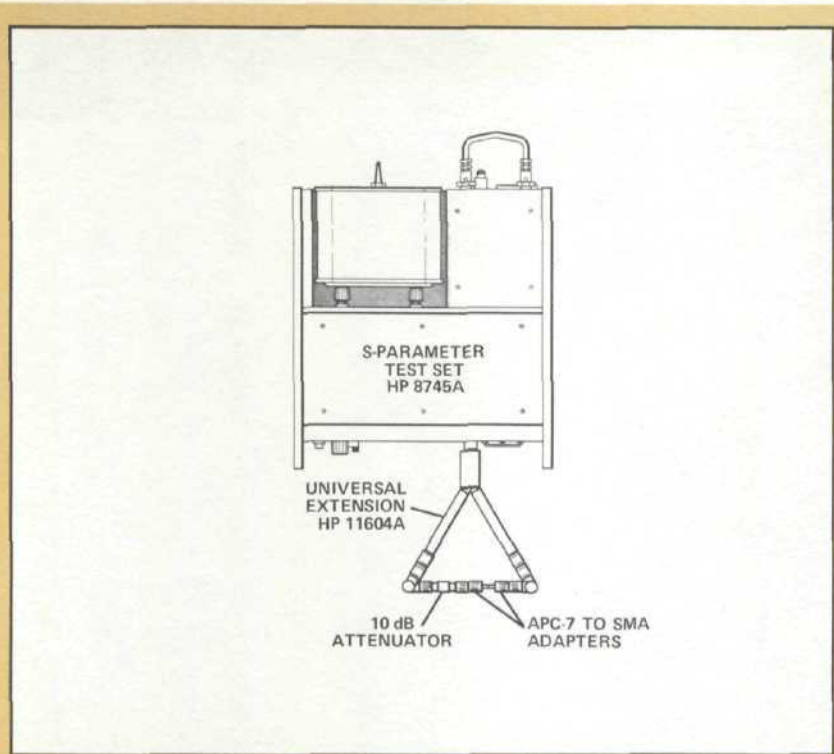

c. Insert the amplifier in the test channel.

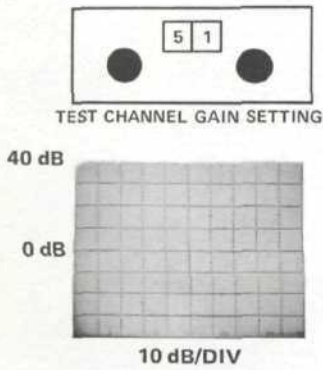
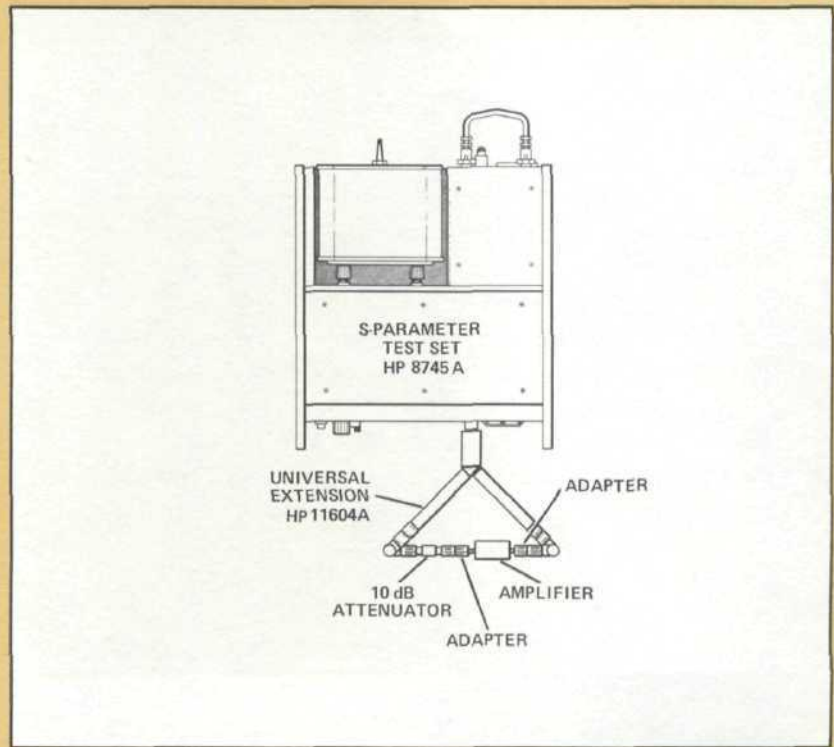

Figure 4-15

Set the proper bias level according to the amplifier specifications. The gain is measured on the 8412A Phase-Magnitude Display. The nominal gain of 40 dB is observed. The biasing voltages are then turned off.

Test Results

4. Grid-Line Procedure

- a. At this point in the test, the X-Y Recorder is adjusted for proper operation on both the X and Y axes. From Step 3c, the nominal gain of the amplifier (40 dB) over the frequency range has been determined. The drawing of grid lines permits a more accurate measurement of this gain. Since approximately 40 dB of amplifier gain will be introduced into the test channel during the measurement, the insertion of 40 dB of attenuation into this same channel will restore the 0 dB output on the display unit by balancing out the 40 dB of gain. Knowing this, one can draw grid or calibration lines with the recorder. The 8410A test channel gain control is adjusted so that these calibration lines can be drawn in one or two dB steps around this initial or zero level. If at calibration, the test channel gain control shows 51 dB, 40 dB of inserted attenuation into this channel decreases this gain control to 11 dB. This reduction of test channel gain by 40 dB is only done during the actual test, *not when drawing grid lines*.
- b. Reduce the test channel gain control setting to 41 dB, or the initial setting minus 10 dB. This represents the 30 dB grid line above the 11 dB test channel gain reading. Set the sweep oscillator to a slow sweep rate and the sweep selector switch to the trigger mode. Lower the recorder pen and trigger the sweeper.
- c. Increase the test channel gain in increments of 2 dB (i.e., to 43, 45, . . . , 55 dB) and draw the lines. This represents the 2 dB grid lines from 30 dB to 44 dB of gain for the test channel gain control setting of 11 dB.

Actual Test Procedure

1. Reduce the 8410A test channel gain control by the nominal gain of the amplifier (40 dB) to the 11 dB setting.
2. Bias the amplifier.
3. Lower the recorder pen and trigger the sweep.

Figure 4-16 represents the end result of this entire procedure. The two amplifier response traces represent two settings of input power to the amplifier. It will be noted that the lower trace falls outside the specification limit, for both gain (40 dB) and flatness (± 3 dB), while the upper trace is within specs for both. This lower trace was obtained by overdriving the amplifier.



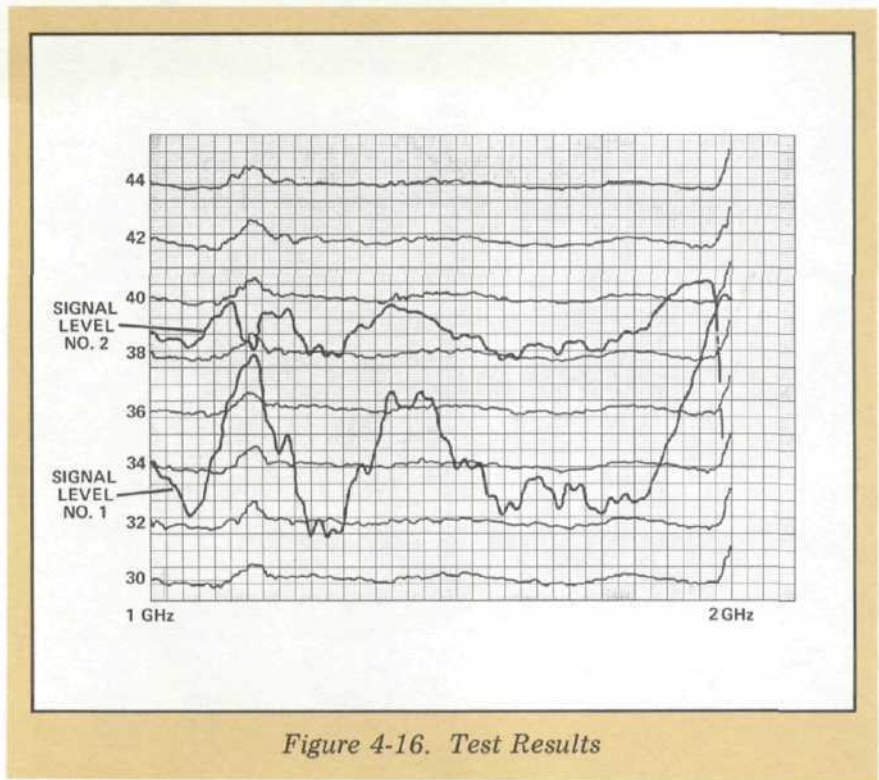

Figure 4-16. Test Results

CHAPTER V

HP 8743A TRANSDUCER APPLICATIONS (2.0 – 12.4 GHz)

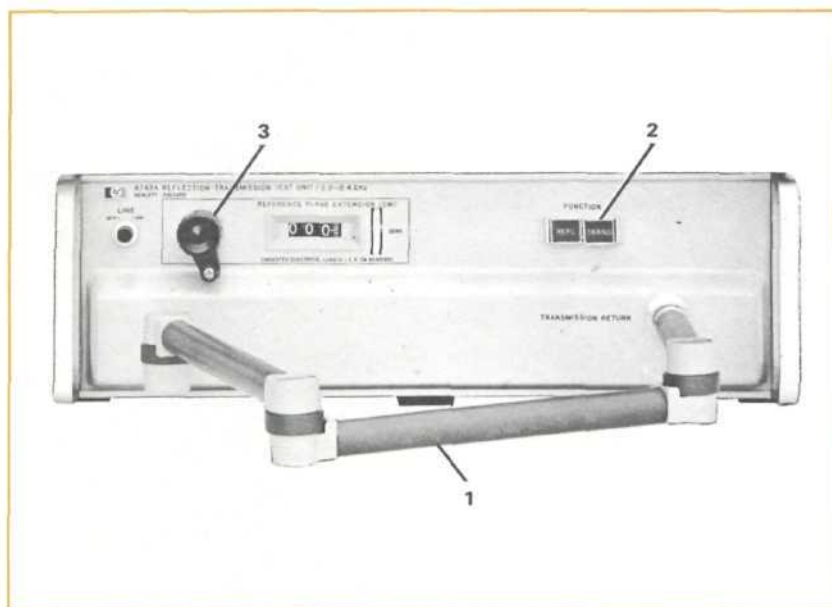

Figure 5-1. The HP 8743A Reflection-Transmission Test Unit

The 8743A Reflection-Transmission Test unit in combination with the 11605A Flexible Arm (No. 1, Figure 5-1), a sweep oscillator and the 8410A Network Analyzer make up a system for making transmission and reflection, phase and magnitude, measurements on microwave components in the 2 – 12.4 GHz frequency range. It is also programmable for automatic usage.¹

With this transducer in the system, transmission or reflection parameters of microwave components can be measured by using the two front panel pushbuttons (No. 2, Figure 5-1). In terms of S parameters, both S_{11} and S_{21} can be measured with one setup. By merely reversing the device under test, the other two S parameters, S_{22} and S_{12} can be determined. Figure 5-2 illustrates this testing procedure in block diagrams.

The reference plane extension (No. 3, Figure 5-1), together with the fixed reference channel extension on the back of the unit are used to equalize the path lengths of the reference and test signals.

This Reflection-Transmission Test Unit is not equipped with bias tees. This means that external bias circuits need to be used for measurements of active semiconductor devices.

¹ A simplified RF schematic diagram is shown in Appendix II.

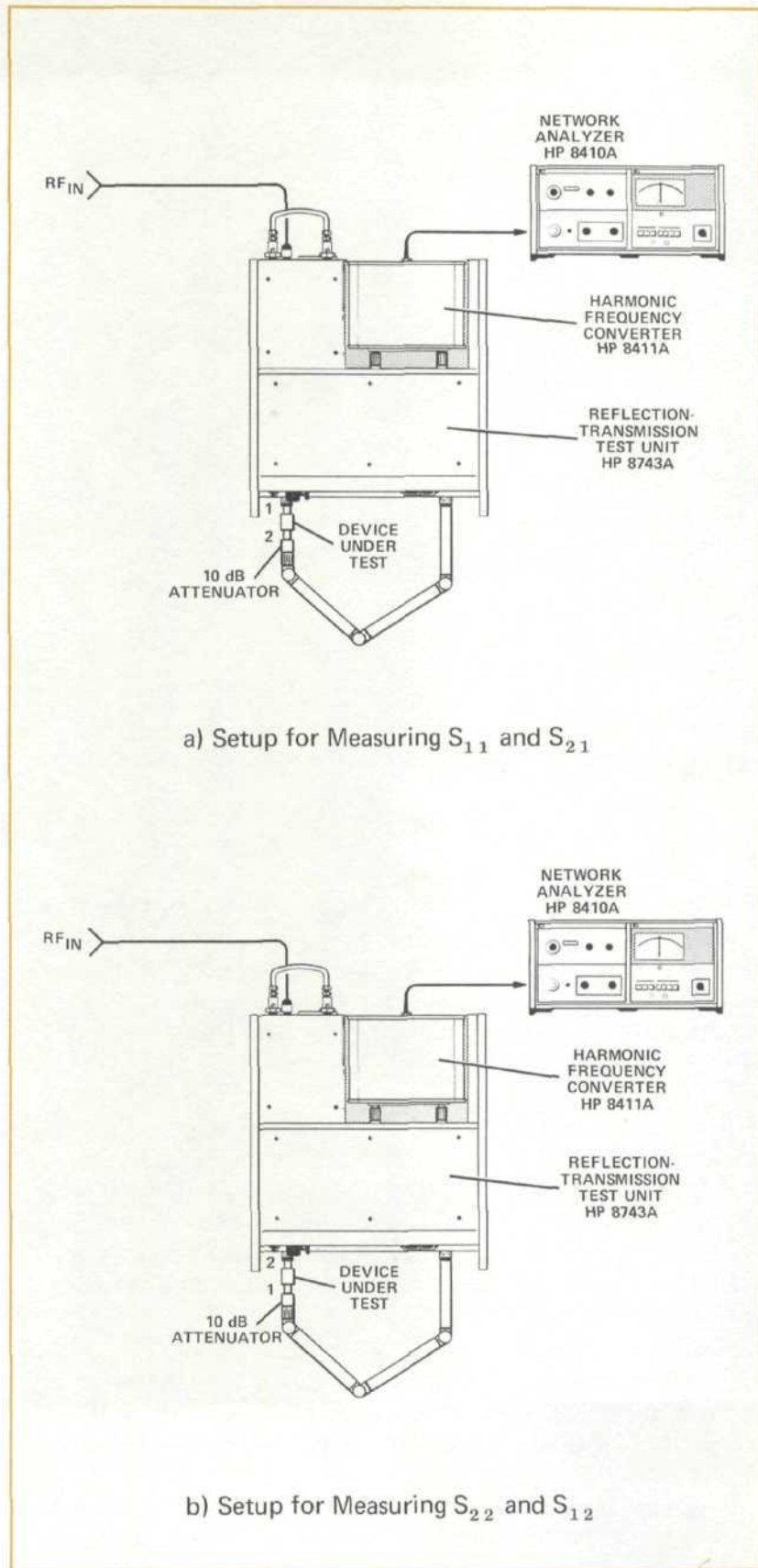

Figure 5-2. Setups for Characterizing Microwave Devices Using the 8743A Test Unit

CALIBRATION

The procedure followed in calibrating the system for reflection and transmission measurements will now be described in detail. It is important that this procedure be followed to ensure proper operation of the system.

When calibrating the system prior to any measurement, be sure to make the calibration using all connections and adapters that will be necessary in the measurement itself; e.g., APC-7 to Type N adapters. This is necessary to ensure that any loss or phase shift introduced by these adapters will be compensated for in the calibration. This precaution applies to any type of measurement and/or calibration described in this chapter.

REFLECTION CALIBRATION

1. **Set up Equipment.** Follow the procedural methods discussed in Chapter III.²

HP 8743A and the
11605A Flexible Arm

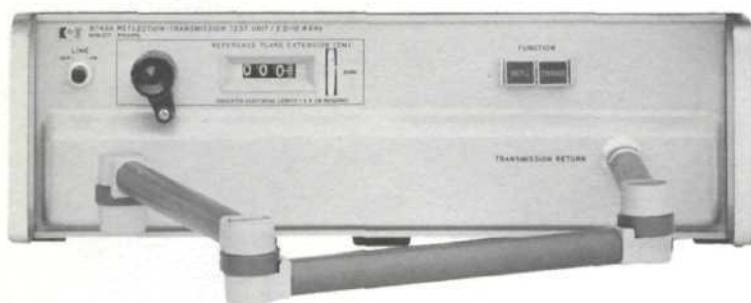

- a. Connect a coaxial short to the 8743A unknown port.
- b. Depress 8743A reflection pushbutton.

²Use the Pre-Test Procedure fold-out in Appendix IV to facilitate your calibration.

2. Typical Results on Two Display Units.

Phase-Magnitude Display³
8412A

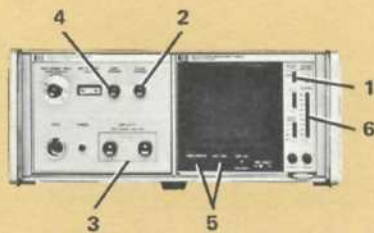

Polar Display
8414A

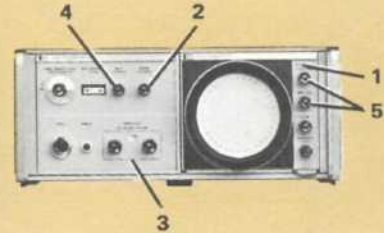

- a. Select Phase mode (No. 1) at $90^\circ/\text{div}$. Adjust horizontal controls (No. 5) for sweep linearity.
- a. Holding beam center switch (No. 1) depressed, adjust vertical and horizontal position (No. 5) until beam is centered on display. Release switch.
- b. Adjust reference plane extension on 8743A for:

Flat Horizontal Line

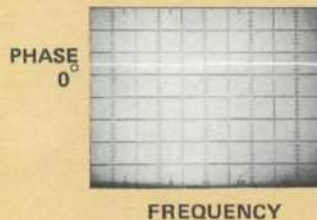

This indicates that the electrical lengths in the incident and reflected channels of the reflectometer are equal.

Dot or Smallest Cluster

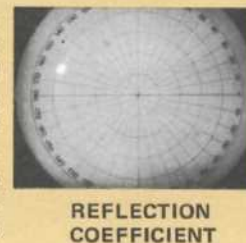

- c. Adjust 8410A phase vernier (No. 2) for:

180° Phase Shift

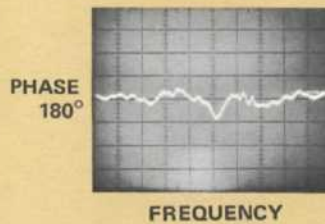

Dot Positioning on 180° Line



Set Degree Offset switch on 8412A (No. 6) to 180° and increase resolution to $1^\circ/\text{div}$ for this step.

³The identical results shown for the 8412A could be obtained with the 8413A and an oscilloscope.

- d. Adjust 8410A test channel gain (No. 3) and amplitude vernier (No. 4) for:

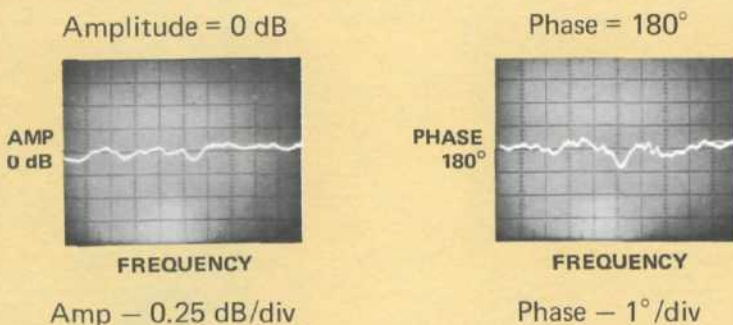

(Select Dual Mode)

$$\rho = 1.0 / 180^\circ$$

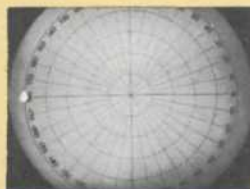

REFLECTION
COEFFICIENT

These adjustments are made to calibrate the displays using a short. The Polar Display must show a reflection coefficient of $1/180^\circ$, and the Phase-Magnitude Display a return loss of 0 dB and 180° .

TRANSMISSION CALIBRATION

1. **Set up Equipment.** Follow the procedural methods discussed in Chapter III.

HP 8743A and the
11605A Flexible Arm

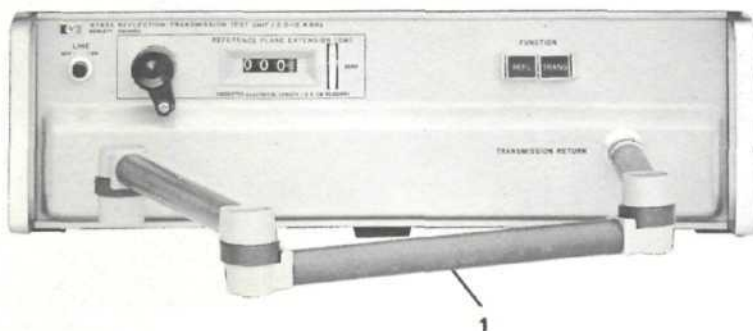

- a. Attach a 10 dB attenuator to the 11605A Flexible Arm (No. 1). (The 10 dB attenuator is connected to the flexible arm during calibration and measurements to reduce any ambiguities due to mismatch between the 11605A Flexible Arm, the 8743A Test Unit and the 8411A Harmonic Frequency Converter. The attenuator reduces the ambiguity to essentially that of the attenuator ($VSWR \leq 1.25$). In addition, the 10-dB attenuator makes the test channel power level during calibration and test the same for transmission and reflection measurements. This allows one to calibrate for one mode of operation and switch to the other during test without recalibrating. Also, the combined electrical lengths of the 11605A and the attenuator make the electrical length of the test channel in the transmission mode nearly equal to its length in the reflection mode.)
- b. Connect the flexible arm to the Unknown and Transmission Return ports.

2. Typical Results on Two Display Units

Phase-Magnitude Display
8412A

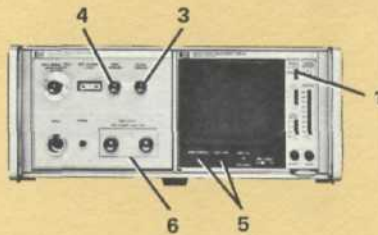

Polar Display
8414A

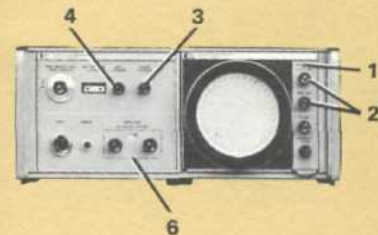

- a. Select Phase mode (No. 1) at $90^\circ/\text{div}$. Adjust horizontal controls (No. 5) for sweep linearity.
- a. Holding beam center switch (No. 1) depressed, adjust vertical and horizontal position (No. 2) until beam is centered on display. Release switch.
- b. Adjust reference plane extension on 8743A for:

Flat Horizontal Line

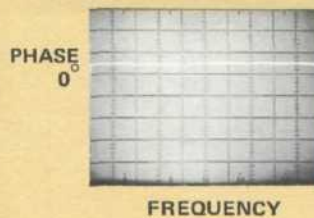

This indicates that the electrical lengths in the incident and reflected channels of the reflectometer are equal.

Dot or Smallest Cluster



c. Adjust 8410A phase vernier (No. 3) for:

0° Phase Shift

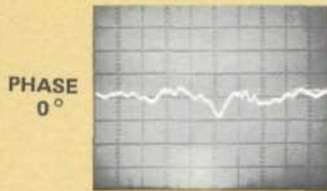

FREQUENCY

Dot Location on 0° Line

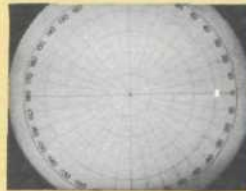

TRANSMISSION
COEFFICIENT

d. Adjust 8410A test channel gain (No. 6) and amplitude vernier (No. 4) for:

Amplitude

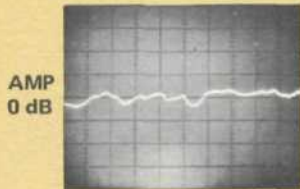

FREQUENCY

Phase

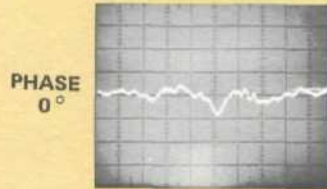

FREQUENCY

Amp – 0.25 dB/div

Phase – 1°/div

(Select Dual Mode)

$$\tau = 1/\underline{0^\circ}$$

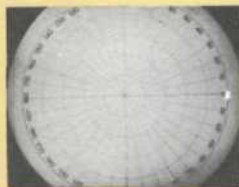

TRANSMISSION
COEFFICIENT

These adjustments are made to calibrate the displays for a through circuit. The Polar Display must show a transmission coefficient = $1/\underline{0^\circ}$ and the Phase-Magnitude Display an insertion loss of 0 dB and 0°. The Network Analyzer system is now properly set up and calibrated for accurate use.

APPLICATIONS USING THE 8743A

GENERAL PROCEDURE

1. Reflection.

Measurements are made in the following manner:

- a. Set up (Figure 5-3) and calibrate the 8410A system, as described previously in this chapter.

- b. Connect the device to be tested directly to the 8743A unknown port. This device should be terminated in its characteristic impedance. Depress the reflection push-button.
- c. On the 8414A Polar Display, read the reflection coefficient, magnitude and phase, directly from the CRT. For impedance measurements, insert the Smith Chart overlay over the CRT and read the impedance directly.⁴
- d. For small reflection coefficients the 8414A resolution can be improved by increasing the test channel gain. For example, increasing the test channel gain by 14 dB changes the full scale reflection coefficient calibration from 1.0 to 0.2

2. Transmission.

Measurements are made in the following manner:

- a. Set up (Figure 5-3) and calibrate the 8410A system.
- b. Insert the device to be tested between the unknown port and the 10 dB attenuator attached to the flexible arm. Depress the transmission pushbutton.
- c.
 - 1) When using the 8414A Polar Display, note the 8410A test channel gain setting. This is the calibrated gain setting obtained earlier. Adjust the test channel gain controls to locate the CRT display on the outside circle. The difference in gain settings is the magnitude of the transmission voltage gain or loss of the device under test. The phase shift through the device can be read directly from the CRT for each frequency of interest by using trace brightening (Marker) to identify the frequency.
 - 2) When using the 8412A Phase-Magnitude Display, one can read the gain or attenuation directly from the display. By switching to the phase mode, the phase shift through the device can be accurately determined.

⁴Refer to the discussion on "Output Interpretation for the 8414A" in Chapter II.

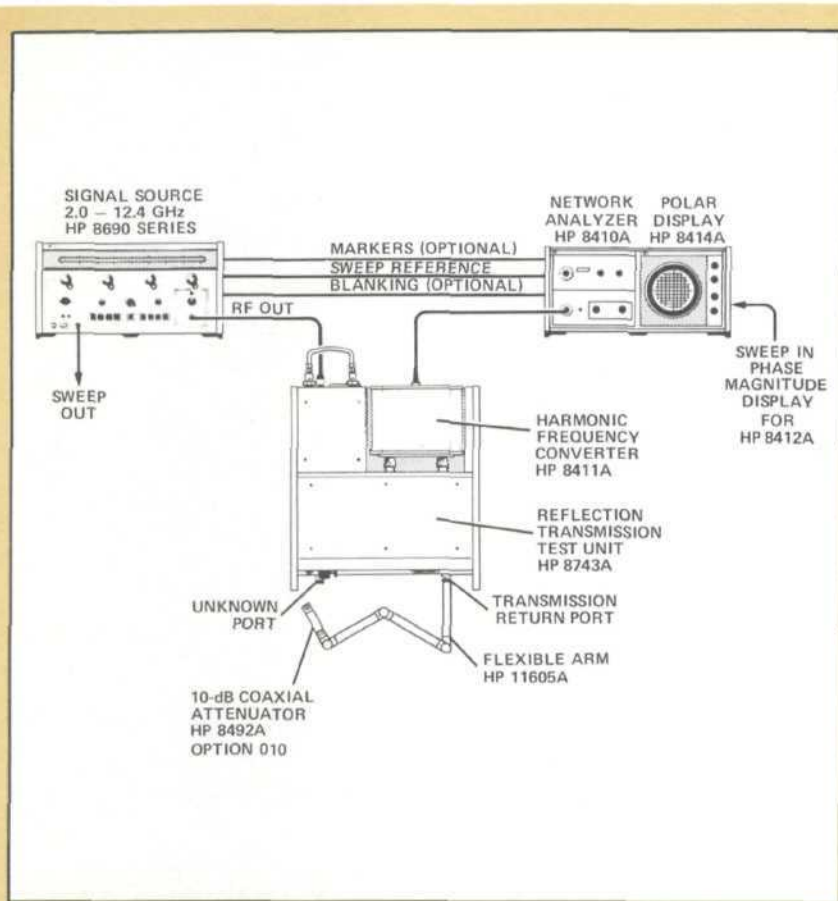

Figure 5-3. General Measurement Setup

REFLECTION MEASUREMENT APPLICATIONS

RETURN LOSS IN A CABLE

Purpose

The purpose of this measurement is two-fold: first, the demonstration of the system for reflection measurements and, secondly, the demonstration of the procedure used to eliminate the directivity-crosstalk of the system. (Directivity was discussed in Chapter II. Crosstalk is a measure of the reference and test channel isolation and is specified as being greater than 65 dB from 0.11 to 6 GHz) and greater than 60 dB from 6 to 12.4 GHz.)

Procedure

To measure a device having a small reflection coefficient, it is necessary to eliminate the directivity-and-crosstalk errors inherent in the systems and then measure the reflection coefficient of the device. In this demonstration, coax cable was tested.

Test Results

a. Test Setup

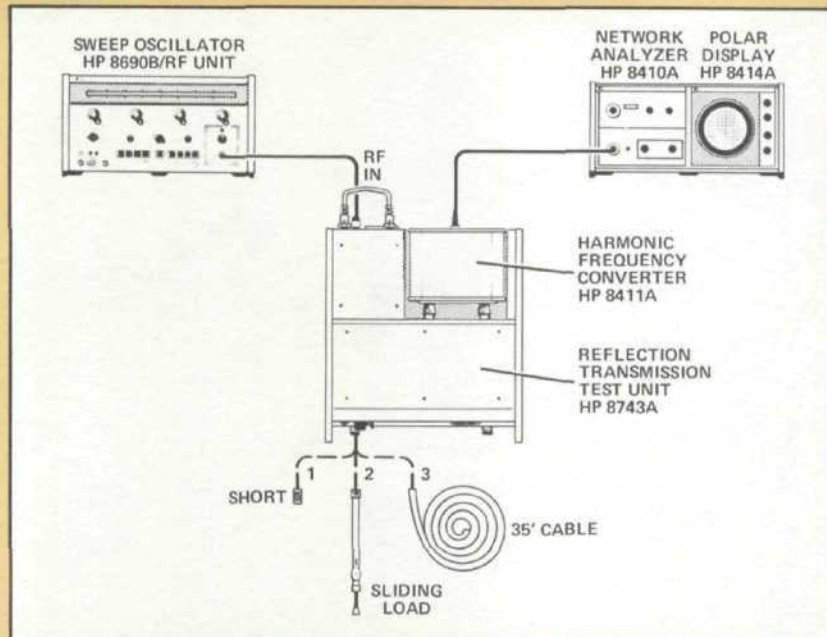
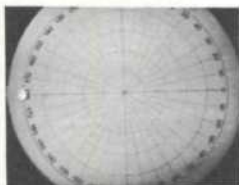

Figure 5-4. Test Setup for Elimination of the Directivity-Crosstalk Error Vector



ρ FULL SCALE = 1

Figure 5-5

- b. Set the sweep oscillator sweep selector to CW and the frequency to 3 GHz, or whatever frequency at which the cable will be used.
- c. Calibrate the system with a short (No. 1, Figure 5-4) being sure to use the adapters that will be used in the actual test. Note the reading in the test channel gain window.
- d. Remove the short and connect a sliding load (HP 905A or 907A) to the unknown port. (A sliding load itself has a small reflection coefficient. As the load is changed, the phase of the reflection coefficient varies while its magnitude remains constant. Figure 5-6 illustrates the effect of moving the load.)

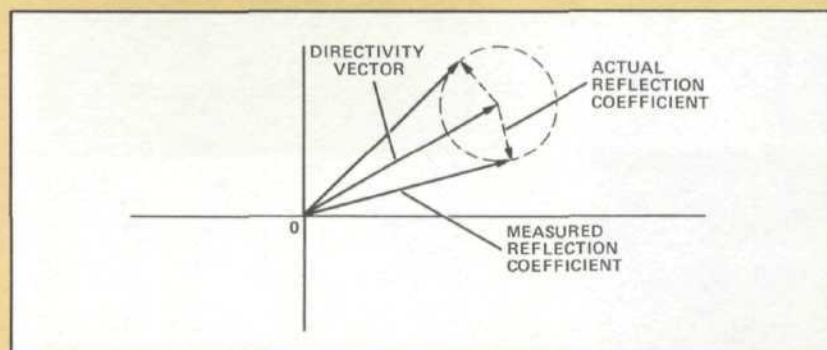

Figure 5-6. Reflection Coefficient Vector Relationships

- e. To see this effect clearly on the 8414A Polar Display, it will be necessary to expand the scale on the display by increasing the gain in the test channel. If 14 dB of gain is added, for example, the outer circle (full scale) represents a reflection coefficient = 0.2.
- f. The center of the circle describing the actual reflection coefficient can now be moved to the origin of the display by adjusting the vertical and horizontal position controls on the 8414A Polar Display. (This has effectively eliminated the directivity and cross-talk error vector from the system for one frequency.)

Precaution: Do not adjust the test channel gain setting or change frequencies after this point.

- g. Remove the sliding load and connect the test device, 35 feet of coax cable terminated in a 50-ohm load, to the unknown port. One dot will appear on the display unit representing the complex corrected reflection coefficient of the load, ρ_c . Figures 5-7 to 5-10 illustrate the results of this test.

As an aside, the directivity vector could have been subtracted algebraically from the uncorrected value of reflection coefficient, ρ_{uc} . Note that this subtraction results from the vector relationship involved. However, by the method outlined in this section, this mathematical step is unnecessary. Figure 5-11 illustrates these vector relationships.

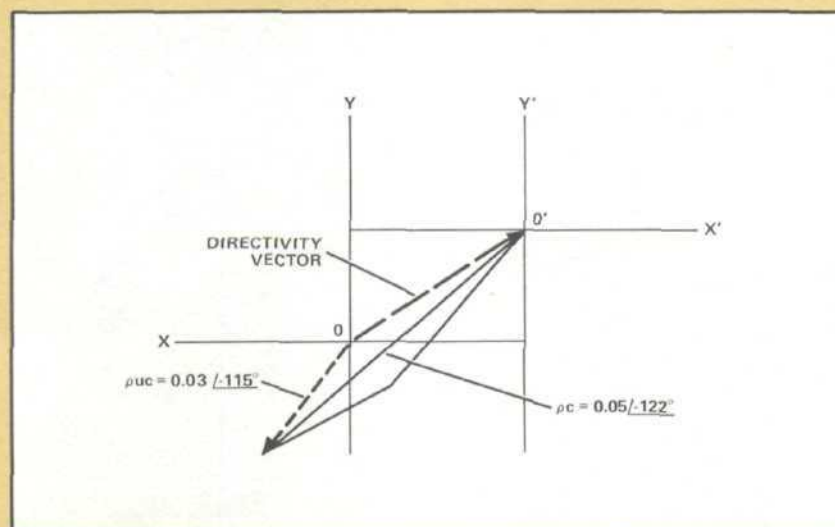
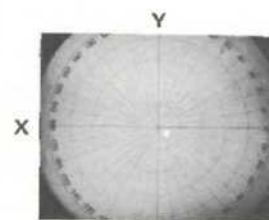

Figure 5-11. Vector Relationships

Test Results



FULL SCALE = 1

Figure 5-7



TEST CHANNEL GAIN SETTING

CENTER OF CIRCLE (TIP OF DIRECTIVITY VECTOR)

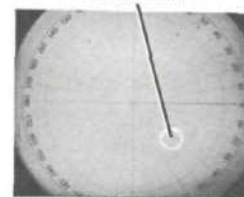

FULL SCALE = 0.2

Figure 5-8

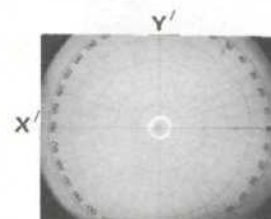

FULL SCALE = 0.2

Figure 5-9

$\rho_c = 0.05 \angle -122^\circ$
RETURN LOSS = 26 dB
VSWR = 1.11

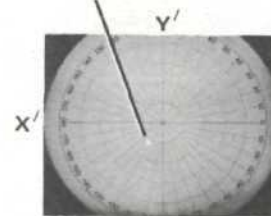

FULL SCALE = 0.2

Figure 5-10

Test Results

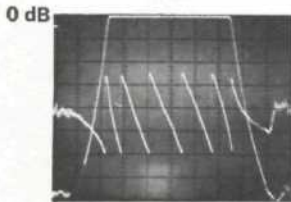

Figure 5-12

TRANSMISSION MEASUREMENT APPLICATIONS

CHARACTERISTICS OF A BANDPASS FILTER

Purpose

The purpose of this measurement demonstration is to illustrate the basic 8743A testing procedure and the procedure for obtaining the 60+ dB of dynamic range of the system. The test filter, Vector Industries Model 1457, has a pass band of 2.5 to 3.5 GHz.

Procedure

- a. Set up system using the Phase-Magnitude Display, and calibrate.
- b. For maximum dynamic range, attach 20-dB attenuator to the reference channel and 3-dB attenuator to the test channel.⁵
- c. Insert filter between unknown port and the 10-dB attenuator attached to the 11605A Flexible Arm.
- d. Press transmission switch on the 8743A and observe display on the Phase-Magnitude Display Unit. (The 0 dB reference line can be shifted up to the top graticule line by increasing the 8410A test channel gain. This ensures the capability of 80 dB full scale on the 8412A display.)

Figure 5-12 illustrates the results of this test.

Precaution: When testing at the maximum dynamic range of the system be sure that the test channel is not driven above -10 dBm. Compression of the IF amplifiers can result is this level is above -10 dBm causing a small error in measurement.

⁵ Refer to "Power Considerations" Section of Chapter III.

CHAPTER VI

HP 8745A S-PARAMETER MEASUREMENTS OF SEMICONDUCTOR DEVICES

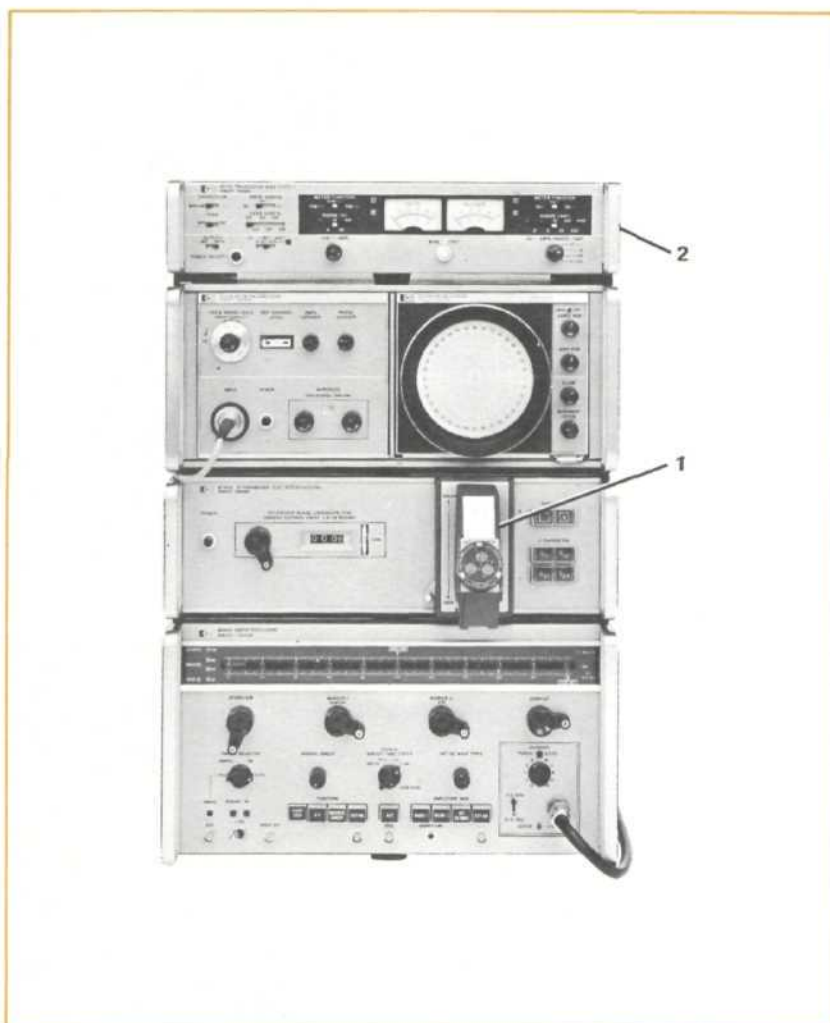

Figure 6-1. Semiconductor Measuring System

INTRODUCTION

The S-Parameter Test Set, HP 8745A, has been discussed in detail in Chapter IV. The pushbutton ease, demonstrated in that chapter when measuring microwave devices, is equally well suited for the measuring and characterizing of semiconductor devices.

The semiconductor measuring system, shown in Figure 6-1, contains the 8745A Test Set along with the accessories developed for the measurement of semiconductor devices.

The test device, in this case a semiconductor, is measured by means of Transistor Fixtures (No. 1, Figure 6-1) shown in Figure 6-2.

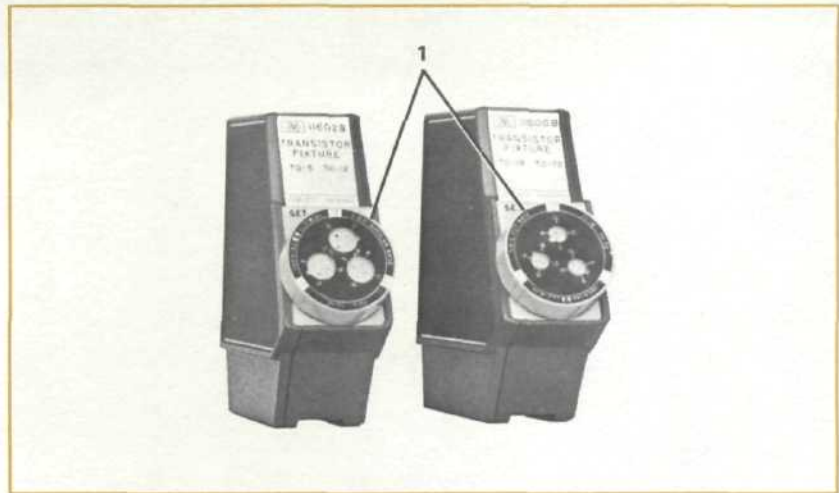

Figure 6-2. Transistor Fixtures HP 11600B/11602B

These fixtures will accept either bipolar or field effect transistors (FET) in a variety of packages. The snap-on dials (No. 1, Figure 6-2) orient the transistor for either common emitter-base-collector or common source-gate-drain configuration.

In addition, the dials when rotated to the proper configuration will indicate which input port button must be depressed during the measurement. This eliminates the problem, alluded to in Chapter IV, of tracing the input or output ports for the various configurations.

The second accessory used in semiconductor measurements is the Transistor Bias Supply (No. 2, Figure 6-1), HP 8717A, shown in Figure 6-3.

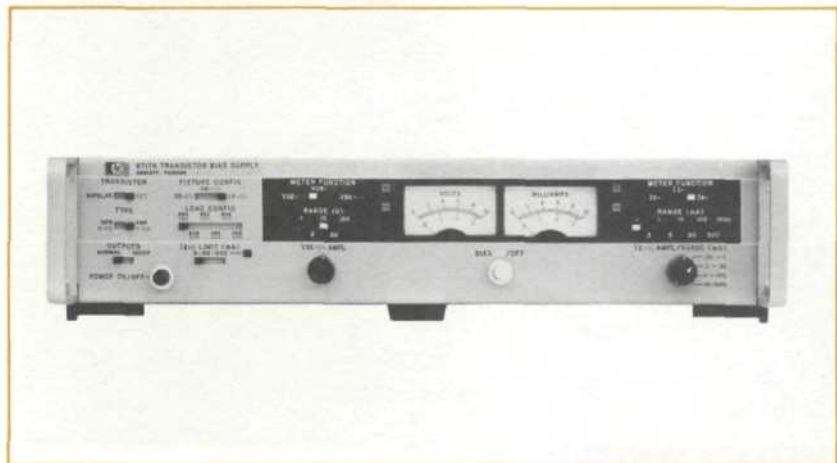

Figure 6-3. Transistor Bias Supply, HP 8717A

This bias supply is connected to the 8745A test set by means of a 36-pin cable. It includes two supplies — constant voltage and constant current — and a number of switches enabling any transistor to be biased quickly and accurately. These switches on the front panel correspond to the different positions of the

snap-on dials for the transistor fixtures. This eliminates the need for external wiring changes for each new configuration; that is, common emitter-base-collector or common source-gate-drain. While the transistor is biased for one particular configuration, the switches allow monitoring of the voltages and currents on any of the three leads of the transistor under test.

PROCEDURE FOR TRANSISTOR MEASUREMENTS

CALIBRATION

The method for calibrating the system when using the 8745A with the transistor fixtures is sufficiently different from the methods previously described that it merits this special section.

HP 8745A with the 11600B Transistor Fixture attached



REFLECTION CALIBRATION



1. **Set up Equipment.** Follow the procedural methods discussed in Chapter III.¹
 - a. Select dial according to the test device, e.g., the EBC Bipolar Dial and then snap the dial on the 11600B.
 - b. Plug in Short termination.² Make sure HP is at the bottom of the dial and the arrow on the Short points up as shown in the figure above.
 - c. Depress A Input Port and S_{11} switches.

¹Use the Pre-test Procedure foldout in Appendix IV to facilitate your calibration.

²The "Short" and "Thru" calibrated units are included in the packaging case for the Transistor Fixtures, 11600B/11602B. For older calibration units, separate packaging (HP 11601A/11603A) was provided.

2. Typical Results on Two Display Units

Phase-Magnitude Display ³
8412A

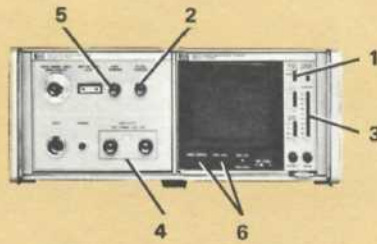

Polar Display
8414A



- a. Select Phase mode (No. 1) at 90°/div. Adjust horizontal controls (No. 6) for sweep linearity.
- b. Holding beam center switch (No. 1) depressed, adjust vertical and horizontal position (No. 2) until beam is centered on display. Release switch.
- b. Adjust reference plane extension on 8745A (No. 4) for:

Flat Horizontal Line

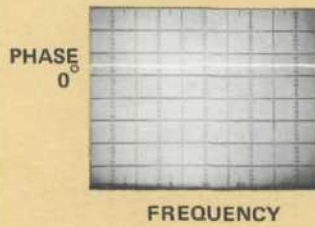

Dot or Smallest Cluster

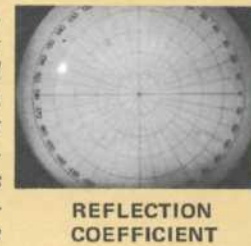

This indicates that the electrical lengths in the incident and reflected channels of the reflectometers are equal.

- c. Adjust 8410A (No. 2) phase vernier for:

180° Phase Shift

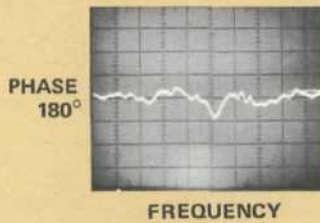

Dot Positioning on 180° Line

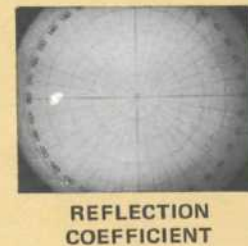

Set degree offset switch on 8412A (No. 3) to 180° and increase resolution to 1°/div for this step.

³The identical results shown for the 8412A could be obtained with the 8413A and an oscilloscope.

- d. Adjust 8410A test channel gain (No. 4) and amplitude vernier (No. 5) for:

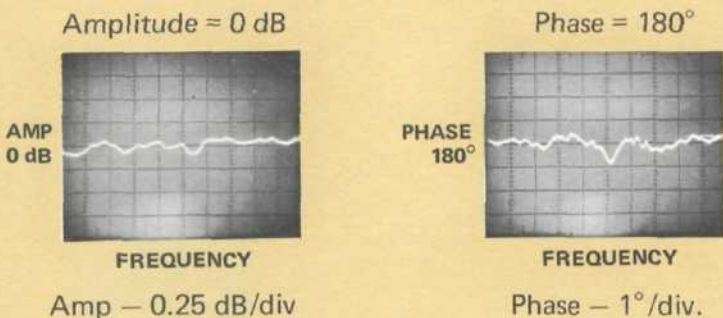

(Select Dual mode)

$$\Gamma = 1.0 \angle 180^\circ$$

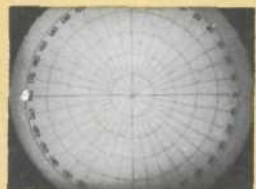

REFLECTION COEFFICIENT

These adjustments are made to calibrate the display using a short. The Polar Display must show a reflection coefficient of $S_{11} = 1 \angle 180^\circ$ and the Phase-Magnitude Display a return loss of 0 dB and 180°.

TRANSMISSION CALIBRATION

- a. Remove SHORT Termination and *plug in THRU Termination.*



Depress $S_{2,1}$ Switch

- b. Typical Results on the Two Display Units:

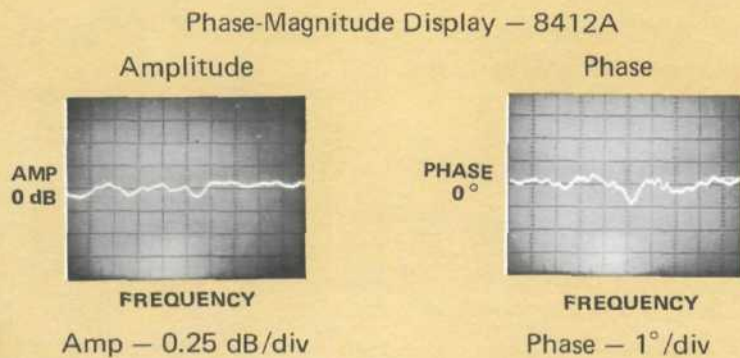

Polar Display – 8414A

$$\tau = 1/0^\circ$$

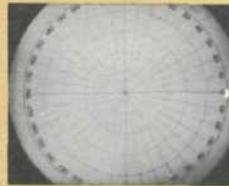

TRANSMISSION
COEFFICIENT

Notice that the 8745A is in almost perfect calibration for transmission measurements, S_{21} , even though it has been calibrated for reflection, S_{11} . This is because the 8745A and the transistor fixture are symmetrical.

SEMICONDUCTOR MEASUREMENTS

Purpose

In this particular application, a 2N3478 900 MHz silicon NPN bipolar transistor will be used to demonstrate the procedure to be followed in making transistor measurements.

The little notches in the snap-on dial properly orient the transistor for any one of the three standard circuit uses: common base, common emitter or common collector. In this example, the common emitter measurement will be made.

When looking at the bottom of the transistor, the clockwise lead arrangement is E-B-C (Emitter-Base-Collector).

The proper bias conditions for the 2N3478 are:

collector-emitter voltage, $V_{CE} = 10 \text{ V}$

emitter current, $I_E = 10 \text{ mA}$

(Precaution: Know these bias conditions for the transistor to be measured prior to equipment turn on).

Procedure

1. S_{11} and S_{22} (Reflection) Measurements



- a. Rotate the dial to common emitter (CE). Plug in the transistor making sure the tab on its case fits into the notch on the dial. With the transistor snap-on dial in the common emitter mode, the colored notch on the perimeter of the dial lines up with the "set A" port line on the transistor fixture.

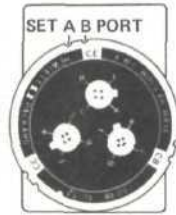

This means that the 8745A Port A is the port connected to the transistor input.

- b. Set Port A pushbutton.



- c. Decrease the RF power until there is just enough to operate the network analyzer as indicated by the reference channel level indicator. This ensures small signal parameters will be measured.



Test Results

d. Biasing

- 1) The 8717A Transistor Bias Supply is connected to the 8745A, turned on and the front panel switches set as in Figure 6-4. Precaution: set switches before turning on the white pushbutton.

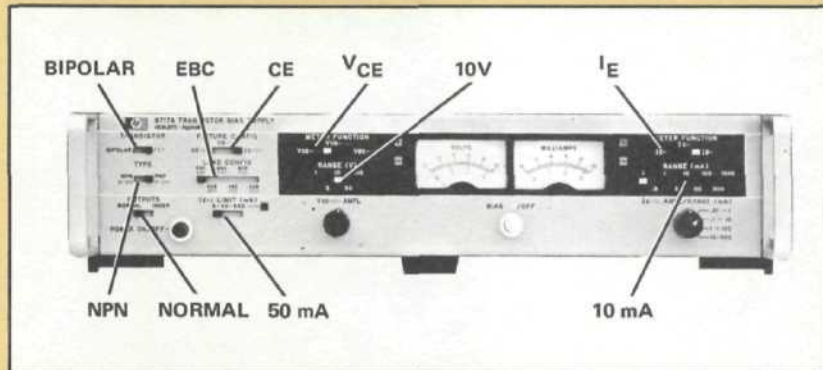

Figure 6-4. HP 8717A Transistor Bias Supply Setup

- 2) Turn up the collector-emitter voltage to 10V. Set the emitter current limit switch to 50 mA and then turn up the emitter current to 10 mA. Once values are established, other voltages and currents can be monitored.

Precaution: Turn up voltage first.

e. Measure S_{11}

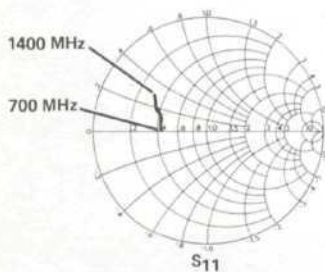
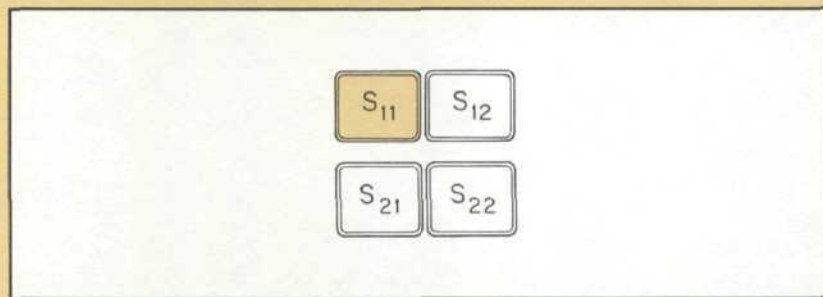

Figure 6-5

(For transistor parameter measurements, the 8414A Polar Display unit is used. Convenient Smith Chart overlays for measuring input or output impedance are easily fitted into the light shield of the display unit.)

$$\frac{Z_{IN}}{Z_0} (700 \text{ MHz}) = 0.42 + j0 \quad \frac{Z_{IN}}{Z_0} (1400 \text{ MHz}) = 0.35 + j0.3$$

f. Measure S_{22}

$$\frac{Z_{OUT}}{Z_0} (700 \text{ MHz}) = 0.7 - j2.2 \quad \frac{Z_{OUT}}{Z_0} (1400 \text{ MHz}) = 2 - j4$$

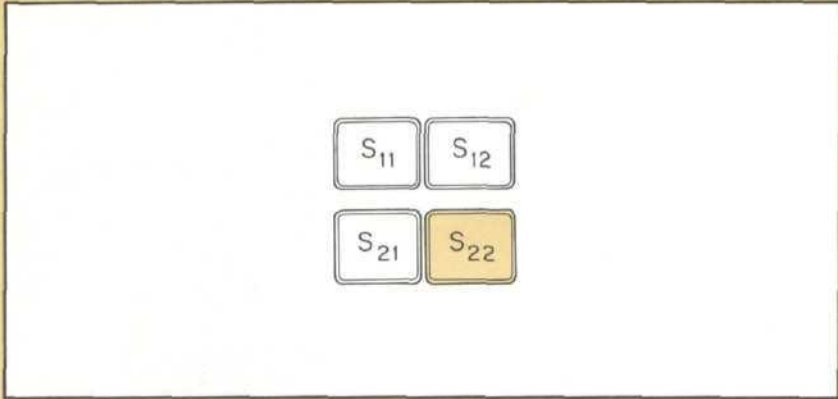

g. At this point, the circuit designer may wish to note how the impedance varies with bias current. By varying the emitter current from 10 mA to 3 mA, the variations in S_{11} and S_{22} can be noted. This important observation is vital when designing circuits since in order to achieve maximum gain, the designer will match both the input and output impedance of the transistor, at the operating bias level, with its conjugate impedance.

2. S_{21} and S_{12} (Transmission) Measurements

a. To measure the transmission (or gain) characteristics, remove the Smith Chart overlay from the 8414A Polar Display and press $S_{1,2}$

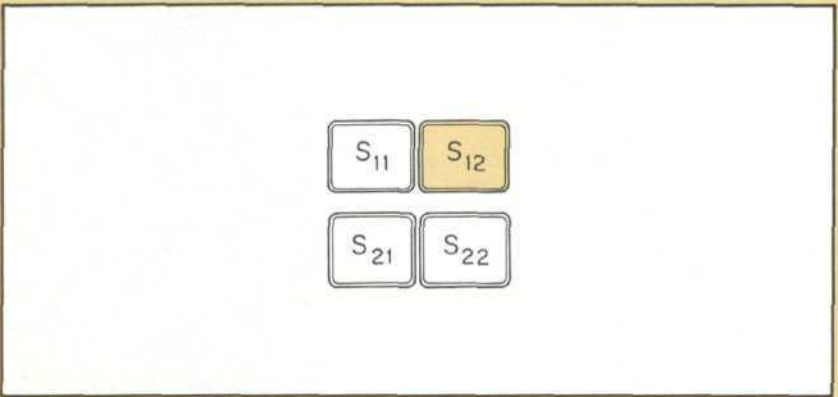

b. *Measure S_{21}* : Since the system was initially calibrated so that the outer circle on the display represented a ratio of the reference signal to the test signal equal to one, this scale can be compressed by reducing the signal in the test channel. To do this, decrease the 8410A test channel gain by any value. However, if it is reduced by 14 dB, then the full scale (outer circle) transmission coefficient is then equal to five; i.e., 14 dB = voltage ratio of 5. This allows the accurate measurement of gains greater than one, as for this transistor's S_{21} parameter, or forward gain of the transistor. Depress the S_{21} pushbutton:

Test Results

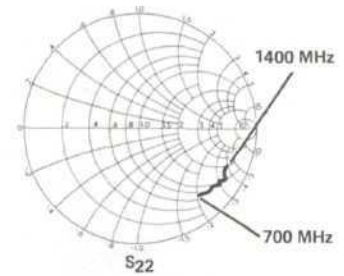

Figure 6-6

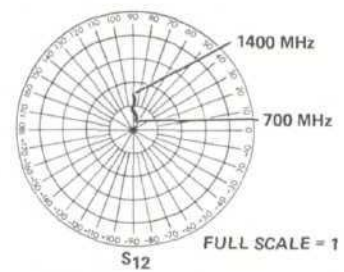

Figure 6-7

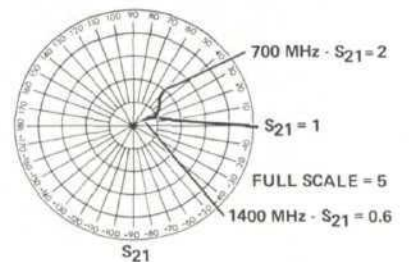

Figure 6-8



- d. Here again, by varying the emitter current bias level from 3 mA to 10 mA, one is able to see how the transistor gain, S_{21} , is affected by bias conditions. (Previously we noted the variation in input and output impedances as a result of varying the bias current. Now we can find the bias point that maximizes the gain. By then repeating the S_{11} and S_{22} measurements for this bias condition, the input and output impedances can be noted so that by conjugate matching the input and output terminals, maximum gain will truly result.)

An intensity marker on the CRT pinpoints the frequency at unity gain ($S_{21} = 1$).

- e. A quick test should be performed at this point to ensure that the small signal parameters are actually being measured. This is accomplished by either reducing or increasing the RF power of the signal source and noting the results on the display for S_{21} . If the changes in S_{21} are minute, the signal level is small enough. Once the RF level has been changed, it is necessary to recalibrate. The following section expands this concept.

S-PARAMETER TRANSISTOR MEASUREMENTS WITH VERY LOW SIGNAL LEVELS

The biggest problem in measuring small signal S parameters with the 8410A system is the transistor drive level. Typically, one would like an incident power level of -30 dBm or lower applied to the semiconductor. With the 8745A and 8410A system described in the previous section, the smallest input drive level is -20 dBm due to the lower power limit of -44 dBm for the reference channel.

With the introduction of an adapter to the 8745A, this input power level is as low as -40 dBm. Figure 6-9 shows how this adapter, the 11607A, can be used with the 8745A.

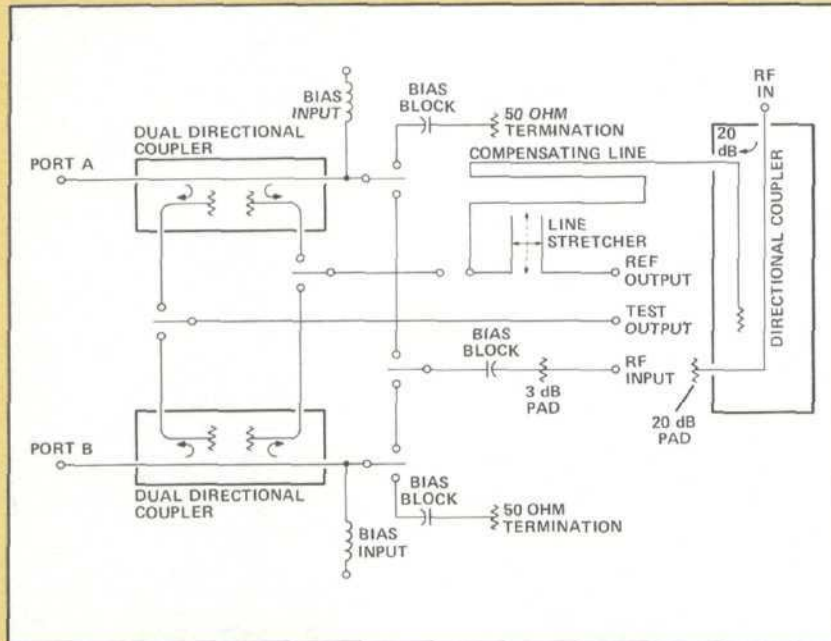

Figure 6-9. The 11607A Adapter

The limitation that this adapter introduces into the system is that the dynamic range of the system is reduced to 40 dB. However, 40 dB is generally more than adequate for transistor measurements.

NEGATIVE IMPEDANCE (TUNNEL DIODE) MEASUREMENTS

CALIBRATION

Again the system must be calibrated but with a slight modification to the procedure described above for transistors.

1. Set up equipment and follow the procedural methods described in Chapter III.¹

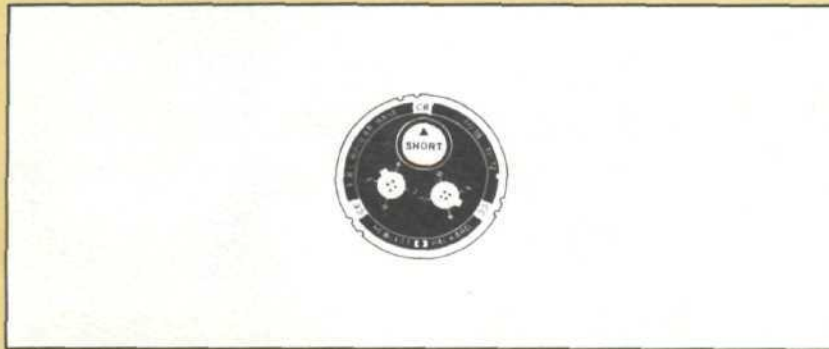

2. Rotate dial so HP is at bottom. Plug in short termination so that the arrow points up, as shown.

¹Use the Pre-test Procedure foldout in Appendix IV to facilitate your calibration.

3. Set Port A and measure S_{22} .

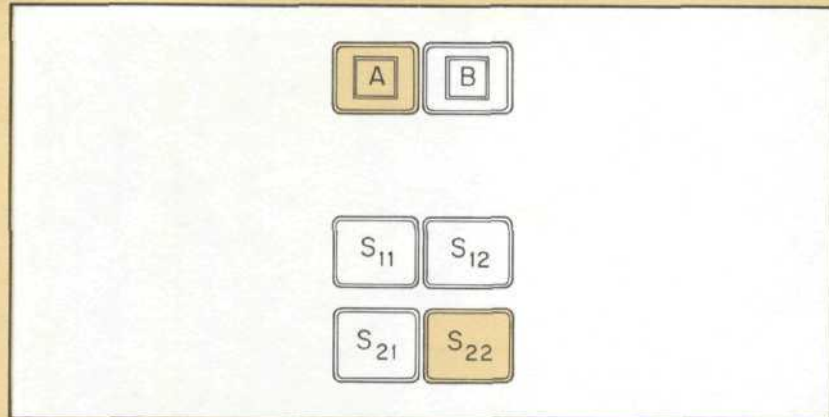

4. Snap the compressed Smith Chart overlay on the polar display.
5. Adjust reference plane extension. Adjust phase vernier. Adjust amplitude vernier to position dot on outer circle and the 180° axis.

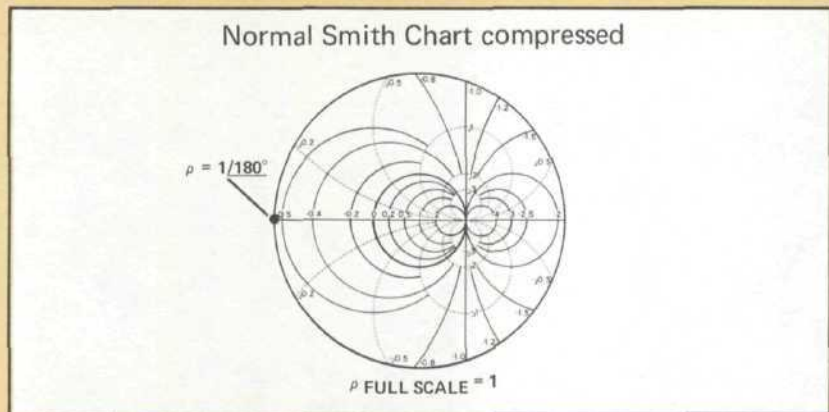

6. Since a tunnel diode with negative resistance has a reflection coefficient greater than one, reduce the 8410A test channel gain by 10 dB. This makes the outer circle equal to a reflection coefficient of 3.16.

Note the $1/180^\circ$ point appears on the left side of the normal Smith Chart where it should be.

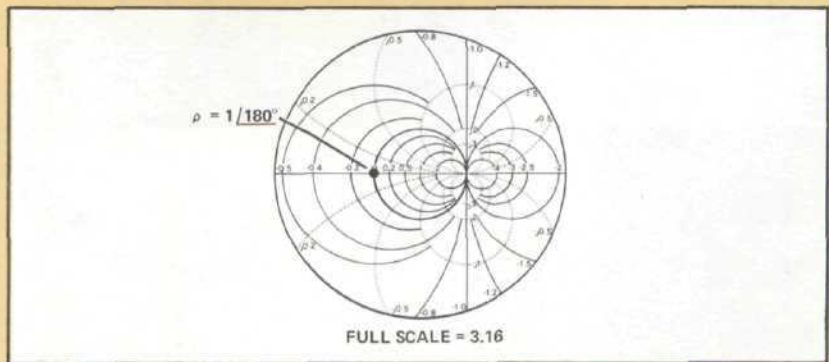

MEASUREMENT

Procedure

A 1N3716 tunnel diode is used in this demonstration measurement.

1. Remove the dial from the transistor fixture. Turn off the bias supply.

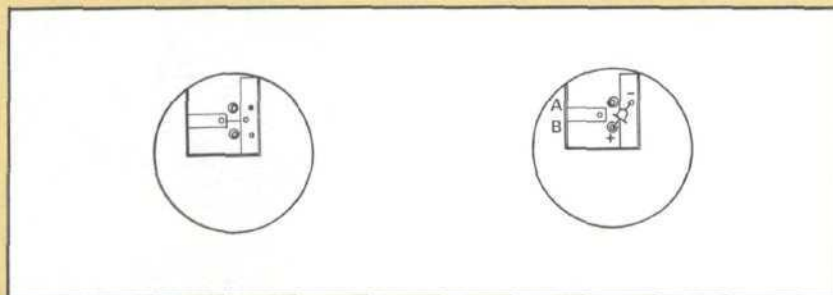

2. Plug the diode in fixture. Make sure positive terminal is in Port B hole.

The RF circuit now looks like this:

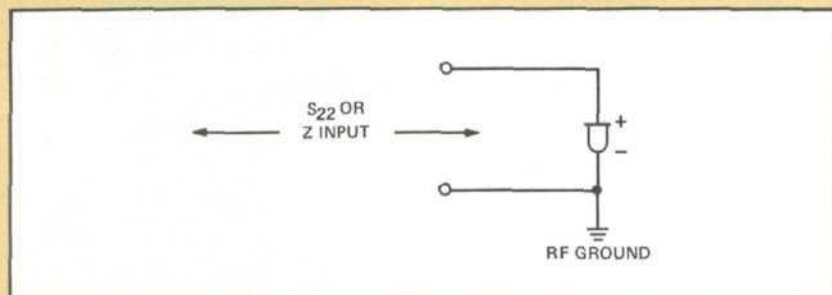

3. Decrease the RF power until there is just enough to operate the network analyzer as indicated by the reference channel level indicator and depress S_{22} pushbutton.

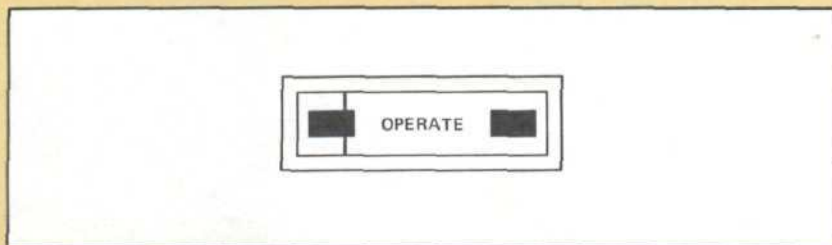

4. Set the 8717A voltage supply range switch to 1V full scale and slowly apply *voltage* to the tunnel diode until the magnitude of the reflection coefficient is as large as possible. The diode is now tunneling since the reflection coefficient is greater than 1. This voltage should be somewhere between 0.065 to 0.35 volts.

Test Results

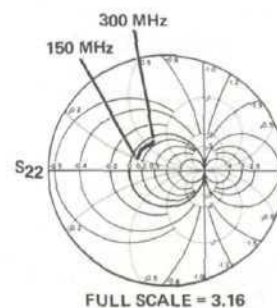

Figure 6-10

Test Results

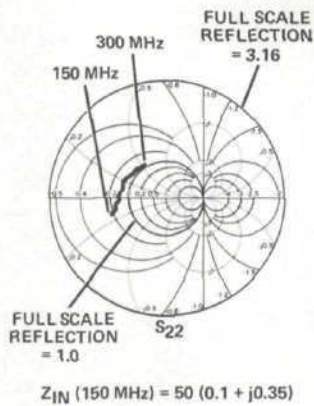
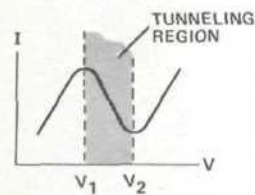

Figure 6-11

(Note: an S parameter setup tends to stabilize negative resistance devices. The total resistance of the diode and the test circuit is positive because the 50 ohm characteristic impedance is typically greater than the negative resistance of the diode.)

Determination of Tunneling Frequency Range

Vary the bias voltage on the tunnel diode and note the bias voltage, V_1 where the diode begins to tunnel and V_2 where it ceases to tunnel.



By using markers on the sweep oscillator, the frequency at which tunneling ceases can be determined. To do this, bias the diode for tunneling again and then raise the RF frequency to sweep between 250-500 MHz. By using a marker on the 8690B, the frequency at which $S_{22} = 1$ can be determined.

CHAPTER VII

HP 8747A WAVEGUIDE MEASUREMENTS (X Band 8.2 – 12.4 GHz) (P Band 12.4 – 18 GHz)

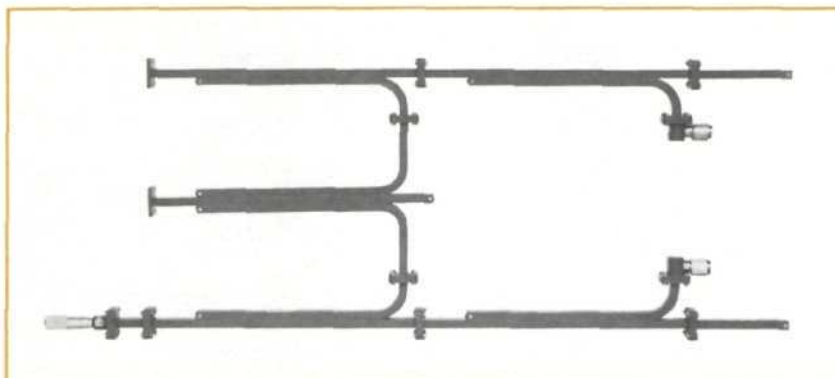

Figure 7-1. The HP 8747A Waveguide Reflection/Transmission Test Unit

INTRODUCTION

The HP 8747A is an X- or P-band¹ transducer for use with the 8410A Network Analyzer system. It contains special waveguide hardware for making reflection and transmission measurements from 8.2 to 12.4 GHz (X8747A) or 12.4 to 18 GHz (P8747A) with the same ease as coaxial measurements with the other transducers.

The 8747A (Figure 7-2) includes a power splitter of the directional coupler type to furnish isolation between the two channels. These equal signals are then fed into two special directional couplers which couple the power into two channels – reference and test. At this point, the reference channel is terminated into a sliding short. Into the test channel are inserted either a shorting plate for calibration, or the test device for either reflection or transmission measurements.

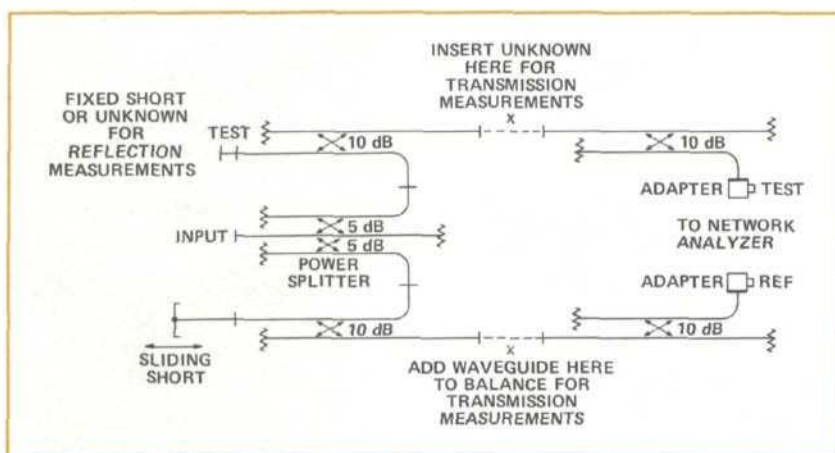

Figure 7-2. HP 8747A Schematic

¹ P Band operation is only possible when using a special 8411A Harmonic Frequency Converter, such as 8411A Option H10.

In the following test procedure discussion, the ease of operation will be evident.

PROCEDURE FOR REFLECTION MEASUREMENTS

Set up equipment and follow the procedural method described in Chapter III.¹ Figure 7-3 illustrates how the 8747A fits into the 8410A system:

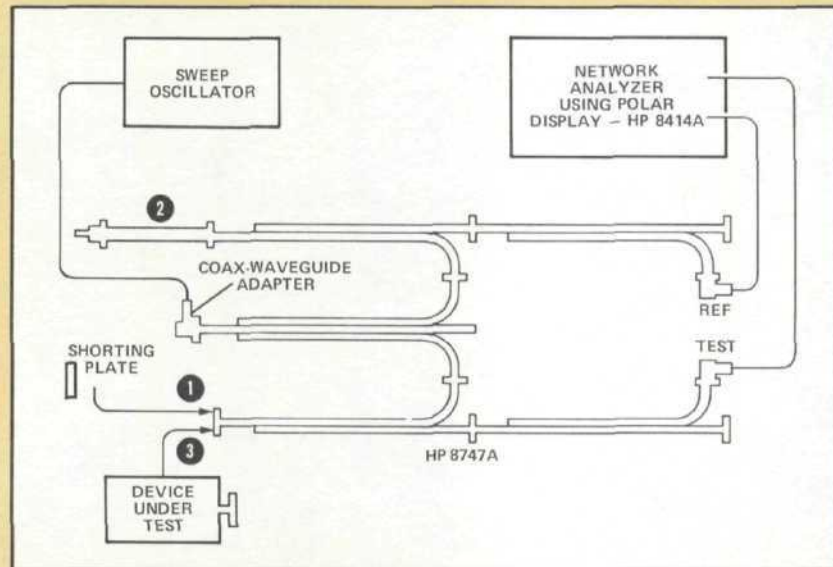

Figure 7-3. 8747A Reflection Test Setup

Note:

If an unbroken trace cannot be obtained with the network analyzer sweep stability control, the RF power may be varying too widely. Try leveling the sweep oscillator.

CALIBRATION

1. Attach shorting plate to the reflection test port (No. 1, Figure 7-3).
2. From this point, proceed as with any other transducer; i.e., by moving the sliding load (No. 2, Figure 7-3), the electrical lengths of the reference and test channels are equalized and a dot or small cluster appears on the 8414A Polar Display. Adjust vernier controls for a reading of $\Gamma = 1/180^\circ$.

MEASUREMENT

1. Remove shorting plate and connect the device under test to the reflection test port (No. 3, Figure 7-3).
2. Read reflection magnitude and phase on the display unit.

¹Use the Pre-Test Procedure foldout in Appendix IV to facilitate your calibration.

PROCEDURE FOR TRANSMISSION MEASUREMENTS

Equipment Setup

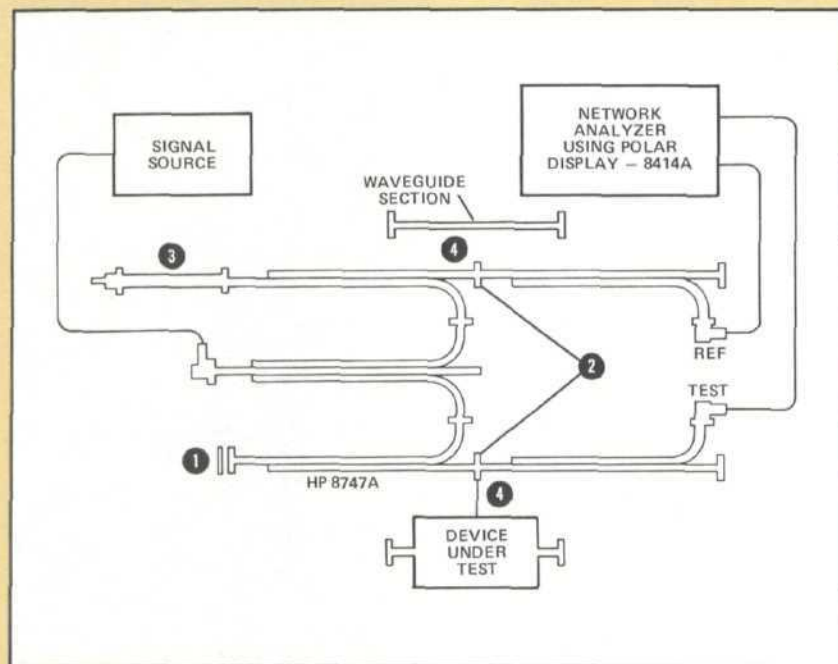

Figure 7-4. HP 8747A Transmission Test Setup

CALIBRATION.

The system is calibrated as in a reflection measurement. NOTE: Do not insert the device under test (No. 4, Figure 7-4) until the system is calibrated.

MEASUREMENT

1. Open the 8747A Test Unit sections and insert the device under test (No. 4, Figure 7-4) into the test channel and a section of waveguide (No. 4) of equal physical length into the reference channel.
2. Read the transmission loss (or gain) and phase on the output display unit.
 - a. A correction of 180° must be added to all phase indications because the reference setting was made with a short circuit (e.g., phase reading of $+60^\circ = 180^\circ + 60^\circ$ or -120°).
 - b. To determine the electrical length of the test device, note initial sliding-short setting at calibration, then adjust the sliding-short to return the swept phase display to a horizontal line. The electrical length is equal to the device's physical length plus twice the change in the sliding-short settings.

To improve the accuracy in small attenuation measurements, calibrate the system with equal lengths of waveguide in the test and reference channels. The measurement is then made by replacing the test channel waveguide by the test device. In this way, any attenuation introduced by the reference channel waveguide will be compensated for.

DIELECTRIC CONSTANT DETERMINATION

The dielectric constant (sometimes referred to as relative permittivity) of a material can be established using the 8410A. Figure 7-6 illustrates the test setup.

THEORY

The basis for the theory behind the measurement is the "transmission line analogy of wave propagation."² From this concept, the reflection coefficient, transmission coefficient, and the standing wave ratio are defined as follows:

$$(1) \text{ Reflection Coefficient, } \rho = \frac{E_r}{E_i} = \frac{\eta_2 - \eta_1}{\eta_2 + \eta_1}$$

$$(2) \text{ Transmission Coefficient, } \tau = \frac{E_2}{E_i} = \frac{2 \eta_2}{\eta_2 + \eta_1}$$

$$(3) \text{ Standing Wave Ratio, } S = \frac{|E_x(z)|_{\max}}{|E_x(z)|_{\min}} = \frac{1 + |\rho|}{1 - |\rho|}$$

where,

$$(4) \eta_1 = \sqrt{\frac{\mu_1}{\epsilon_1}} \text{ and } (5) \eta_2 = \sqrt{\frac{\mu_2}{\epsilon_2}}$$

$$(6) \mu = \text{ permeability}$$

$$(6A) \mu_r = \frac{\mu}{\mu_0}$$

$$(7) \epsilon = \text{ permittivity}$$

$$(7A) \epsilon_r = \frac{\epsilon}{\epsilon_0}$$

and the wave description is taken from Figure 7-5.

²"Fields and Waves in Communication Electronics", Ramo, Whinnery, and Van Duzer. John Wiley & Sons, Inc., 1965, pg. 344.

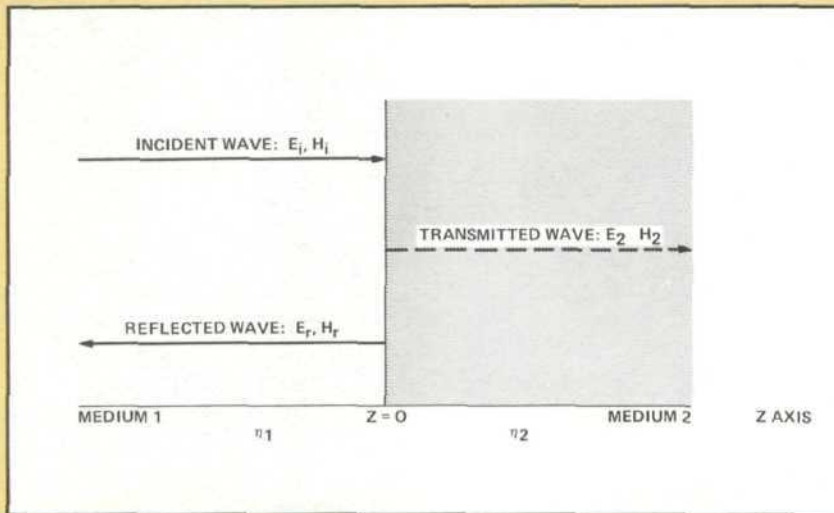

Figure 7-5. Wave Description Definition

Substituting equation (1) in equation (3), it may be shown that for real η :³

$$(8) \quad S = \begin{cases} \eta_2/\eta_1 & \text{if } \eta_2 > \eta_1 \\ \eta_1/\eta_2 & \text{if } \eta_1 > \eta_2 \end{cases}$$

PROCEDURE

The dielectric constant of a piece of beryllia (beryllium oxide) can be found in the following manner:

1. Equipment Setup

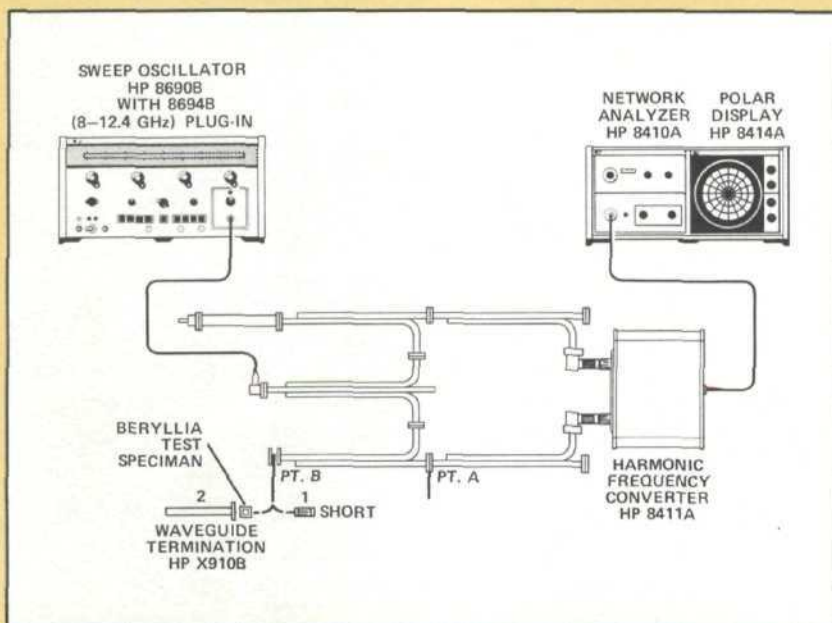

Figure 7-6. Equipment Setup

³Ibid, ppg. 345-348.

2. Reflection Measurement

- a. A short (No. 1, Figure 7-6) is placed on the test channel.
- b. Adjust the 8410A phase vernier and the 8747A sliding short to give the smallest dot or cluster on the 180° axis of the 8414A Polar Display.
- c. Adjust 8410A test channel gain and amplitude vernier for $\rho = 1/180^\circ$.
- d. Place the beryllia material in the test channel, at point B in Figure 7-6, backed by a waveguide termination (No. 2, Figure 7-6), to give the illusion of an infinite half plane.
- e. In order to facilitate computation, set the sweep oscillator to CW and the CW control at 10 GHz.
- f. Measure the reflection coefficient.

Results

The measured reflection coefficient is then converted to S. In this case,

$$\rho = 0.41 \quad \text{VSWR} = S = 2.4$$

Assuming $\eta_1 > \eta_2$, we get:

$$(9) \quad \frac{\eta_1}{\eta_2} = 2.4 \quad (\text{from equation 8})$$

Substituting from (4) and (5):

$$(10) \quad \sqrt{\frac{\mu_1}{\epsilon_1}} = 2.4 \sqrt{\frac{\mu_2}{\epsilon_2}}$$

Since $\mu_2 = \mu_1$ for beryllia, we get:

$$(11) \quad \frac{1}{\epsilon_1} = (5.76) \frac{1}{\epsilon_2}$$

Since $\epsilon_1 = \epsilon_0$, Equation (11) becomes

$$\epsilon_r = 5.76 = \frac{\epsilon_2}{\epsilon_0}$$

where ϵ_r = relative permittivity or dielectric constant.

Since the "dielectric constant of ceramic bodies decreases with increased frequency of the applied voltage"⁴ this value of $\epsilon_r = 5.76$ obtained at room temperature and 10 GHz, corresponds to the tabulated values of less than 6 measured at 25°C and 8.5 GHz.⁵

Very nearly the same value was found by first calibrating the system with the waveguide termination at point B for $\Gamma = 1/0^\circ$, then inserting the beryllia at point A in Figure 7-5. Equation (2) is then used to calculate the dielectric constant.

⁴"Insulating Materials for Design and Engineering Practice", Frank M. Clark, John Wiley & Sons, Inc., New York, London, 1962, pg. 1044.

⁵Ibid, pg. 1092, that based on National Beryllia Corporation, Haskill, New Jersey.

CHAPTER VIII

FURTHER APPLICATIONS

INTRODUCTION

As mentioned in the Introduction to Chapter III, "It is obvious that not all possible applications are listed in these chapters." The applications described, however, should indicate both the versatility of the system as well as its ease of operation and technological contributions.

This chapter will further demonstrate the system's versatility by illustrating a variety of other applications and the results obtained. It is hoped that the entire spectrum of applications presented in this chapter will stimulate the creativity of the user so that he will ask himself: "What can *I* do with this instrument that will facilitate *my* work and provide me with information that was previously too difficult to obtain or too inaccurate to use?"

The methodology of calibration and measurement discussed in detail in the previous chapters will assist the engineer as he uses the network analyzer in the applications he has before him.

REFLECTION MEASUREMENTS

Impedance

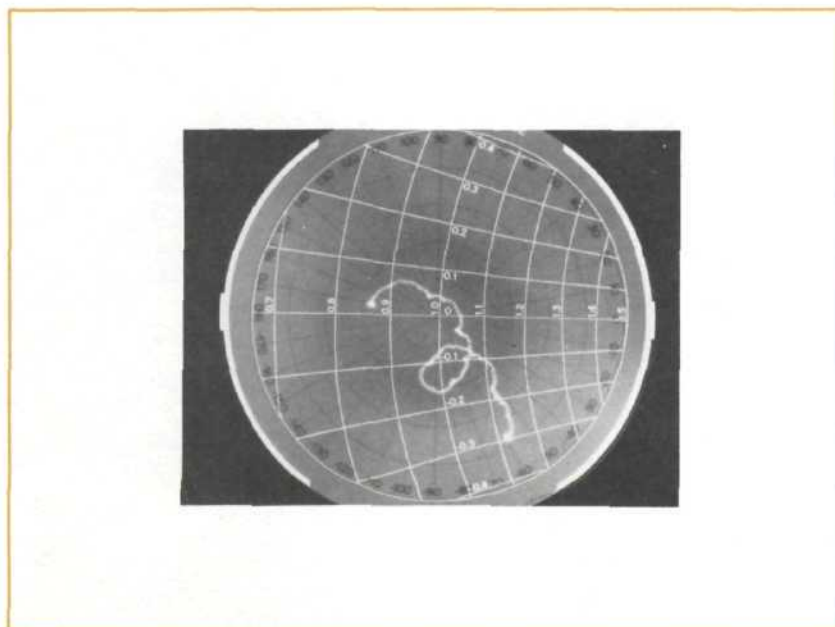

Figure 8-1. Antenna Impedance

Expanded Smith Chart display of the input impedance of a log periodic antenna swept tested between 3.6 GHz and 4.0 GHz. This type of display adds greater resolution to a given measurement making the measurement more definitive. Full Scale $\rho = 0.2$.

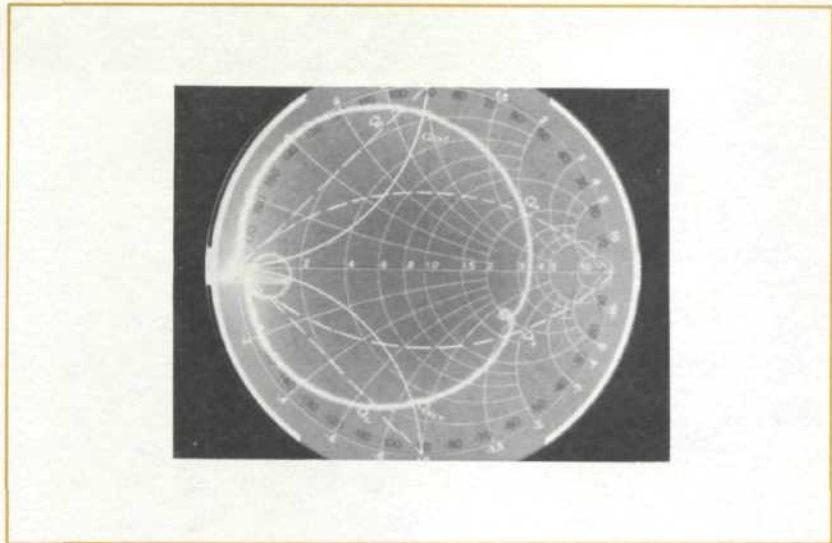

Figure 8-2. Yig Resonant Impedance

Response of a magnetically tuned YIG sphere at $f_0 = 10$ GHz. Δf sweep is 450 MHz. $R_0 \cong 3.5Z_0 = 175$ ohms. The loops, one just below the real axis to the right-center of the photo and the second at the end of the trace at the left of the photo, are parasitic modes. The one on the right is termed a transit mode and moves as a function of resonant frequency. The parasitic mode at the end of the trace is called a stationary mode. Both types of modes must be minimized (or eliminated) before final use of the YIG. Full Scale $\rho = 1.0$

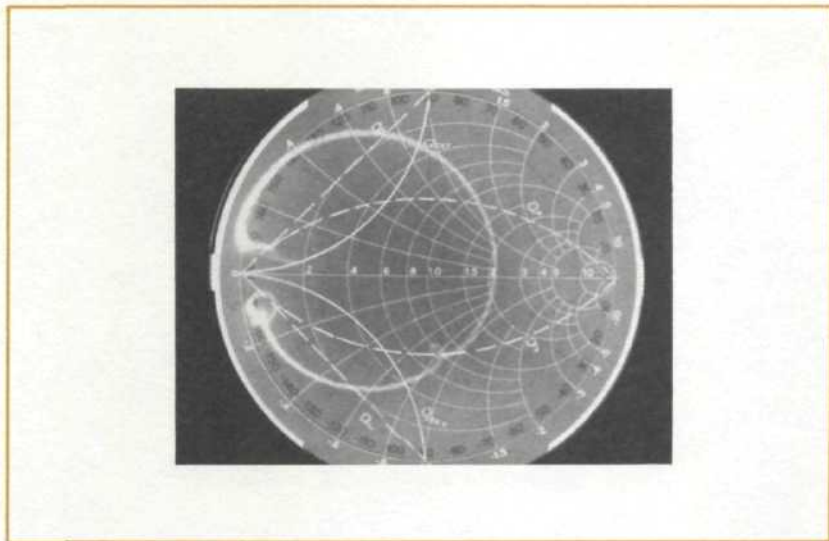

Figure 8-3. Resonant Response of Yig Sphere

Resonant response of a YIG sphere tuned to $f_0 = 11$ GHz. The Δf sweep mode was adjusted to 440 MHz. R_0 can be read from the display to be $2Z_0 = 100$ ohms. Note that the transit mode and stationary mode are present, as in the case of the YIG described previously but that the transit mode has shifted further from resonance. Full Scale $\rho = 1.0$.

DETERMINATION OF Q

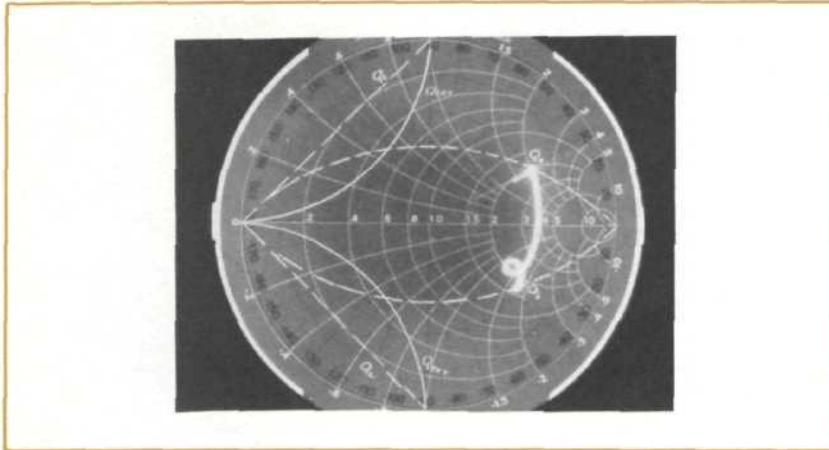

Figure 8-4. Determination of Q of YIG Spheres

By adjusting the resonant frequency $f_0 = 10$ GHz to the real axis of the specially scribed overlay¹ and then using Δf sweep to position the end-points of the sweep at the Q_0 lines on the overlay, the resonant Q of the YIG may be calculated from the following:

$$Q_0 = \frac{f_0}{\Delta f} = \frac{10 \text{ GHz}}{20 \text{ MHz}} = 500$$

Full Scale $\rho = 1.0$

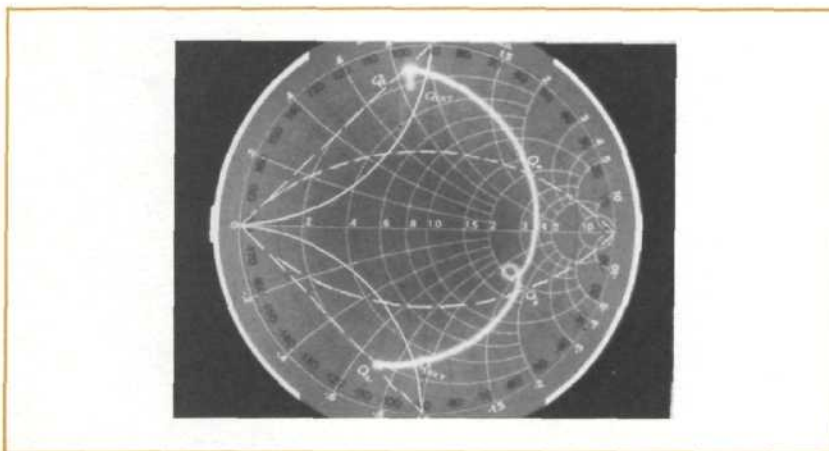

Figure 8-5. Determination of Q of Yig Spheres

The loaded Q of the YIG resonance may be obtained by adjusting the $f_0 = 10$ GHz to the real axis of the Smith Chart and then adjusting Δf such that the end-points of the sweep are on the Q_L lines scribed on the overlay. The loaded Q is then calculated from:

$$Q_L = \frac{f_0}{\Delta f} = \frac{10 \text{ GHz}}{70 \text{ MHz}} = 143$$

Full Scale $\rho = 1.0$

¹See page 8-8 for the method of drawing this overlay.

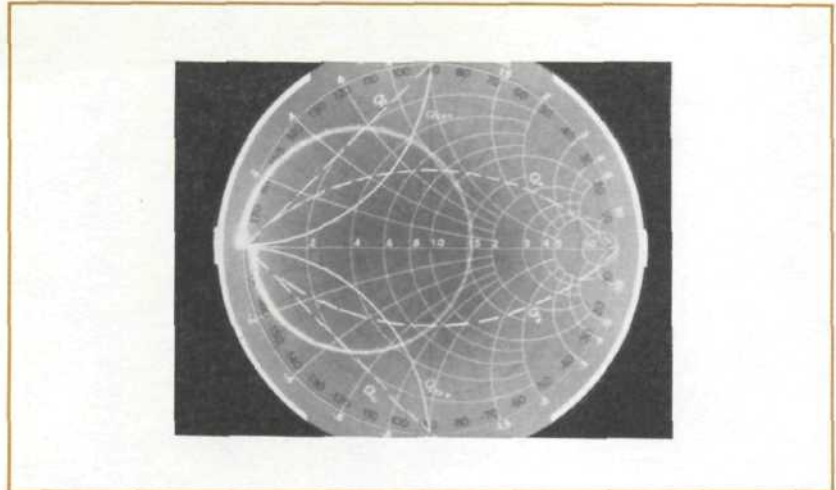

Figure 8-6. Cavity Resonance

Swept-frequency response of a cavity with the Δf sweep adjusted such that the start and stop frequencies are at unity reflection and an impedance of zero. The specially scribed overlay allows rapid calculation of Q by adjusting Δf sweep to the appropriate lines on the overlay and then calculating the Q from:

$$Q = \frac{f_0}{\Delta f}$$

The resonant resistance of the cavity can be read from the real axis of the Smith Chart to be $1.6 Z_0 = 80$ ohms. Full Scale $\rho = 1.0$

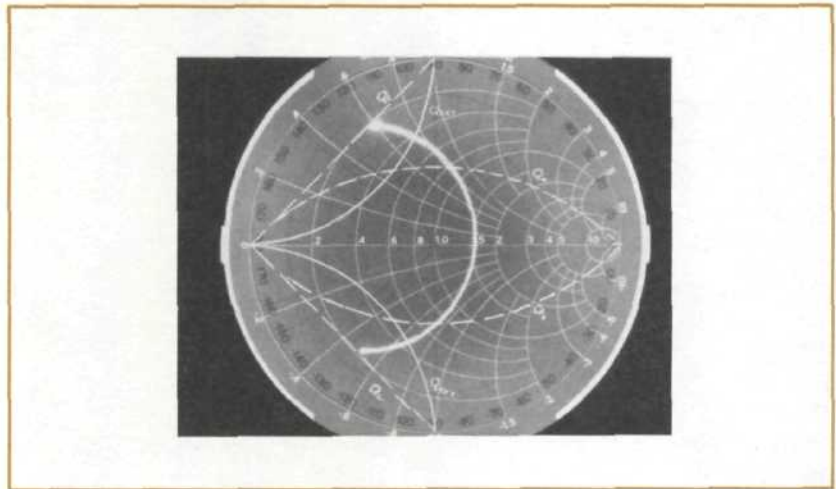

Figure 8-7. Cavity Resonant Response

By adjusting the Δf sweep and cavity resonance such that the resonant response is symmetrical about the real axis on the Smith Chart and then adjusting the Δf sweep so the end points of the sweep are coincident with the Q_L lines on the specially scribed overlay, the Q_L of the cavity can be calculated from:

$$Q_L = \frac{f_0}{\Delta f} = \frac{12 \text{ GHz}}{20 \text{ MHz}} = 600$$

TRANSMISSION MEASUREMENTS

PASSBAND INSERTION

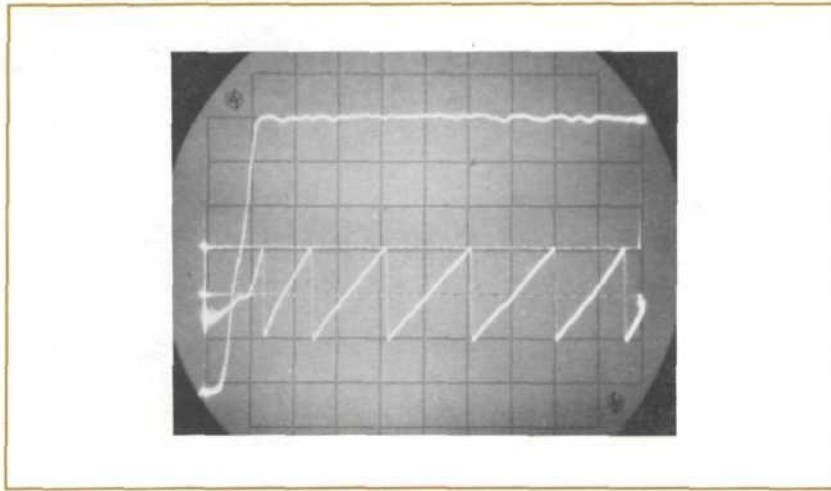

Figure 8-8

High resolution display of the insertion loss of the 8–10 GHz filter in the passband. Swept display between 7.9 GHz and 10.1 GHz with scale of 1 dB/cm. The tracking error of the system was not eliminated by plotting grid lines. Hence, the worst case accuracy of such a measurement would be ± 0.5 dB. Elimination of the tracking error would allow typical accuracy of 0.1 dB excluding possible mismatch errors.

GAIN

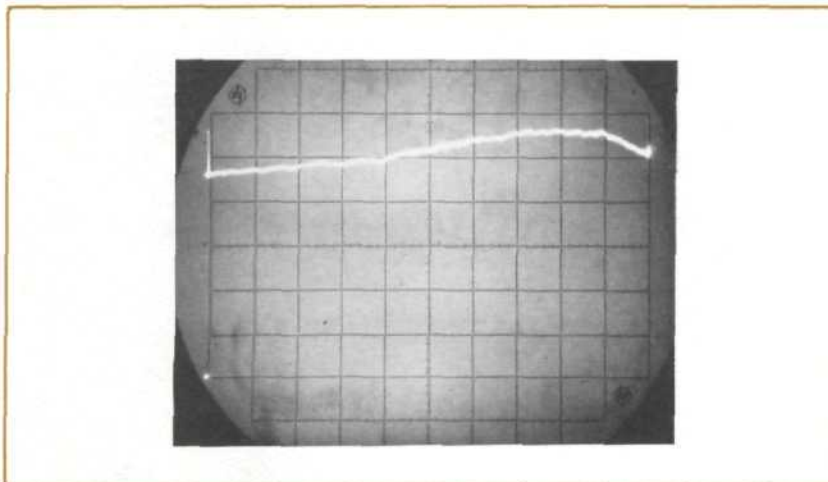

Figure 8-9. Amplifier Gain

Transmission gain at one stage of development of a microcircuit preamplifier swept between 1 GHz and 2 GHz. The variation of the gain may be viewed as a function of frequency. The amplifier, or any component, may be sweep tested at the end of a production line for rapid accept/ reject tests. Scale: 2 dB/cm.

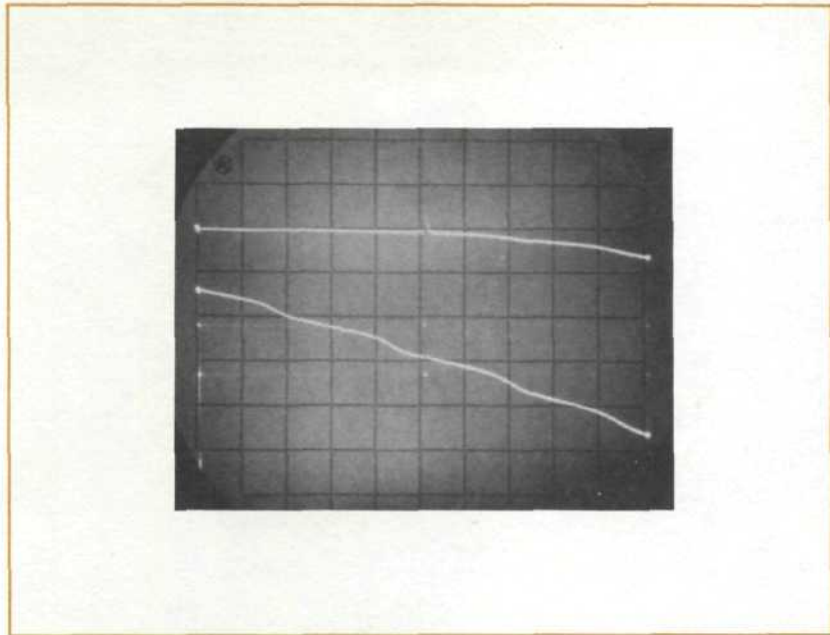

Figure 8-10. Amplifier Gain and Phase

Gain and phase response of a hybrid integrated circuit amplifier in the frequency range 120 MHz to 450 MHz. The break frequency is about 400 MHz. The linearity of the phase shift allows the viewer to predict the distortion due to group delay which the amplifier would introduce into a system which may be used for television broadcasting or telemetry purposes. Scale: 10 dB/cm, 100°/cm

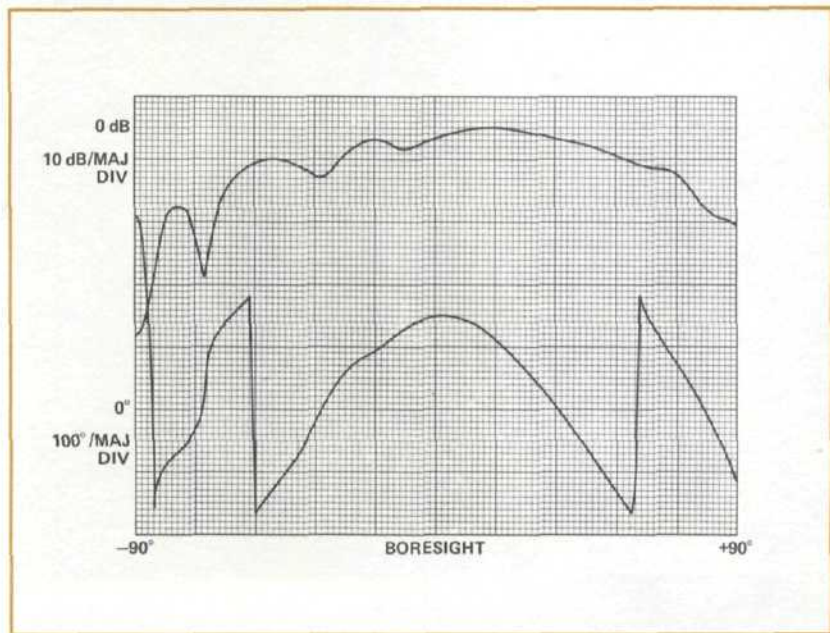

Figure 8-11

Plot of gain and phase pattern of a log periodic antenna at 3 GHz between -90° and $+90^\circ$ azimuth. The plot was not taken in an anechoic chamber and, hence the pattern is not as smooth as it should be. Scale: 10 dB/maj. div., 100°/maj. div.

DESCRIPTION OF Q MEASUREMENT OVERLAY

As we have seen in the applications of Section A, a specially scribed Smith Chart overlay can be used to determine the three parameters: Q -unloaded, Q_o ; Q -loaded, Q_L and Q -external, Q_{EXT} .² Any cavity can be characterized by a simple R-L-C resonant circuit.

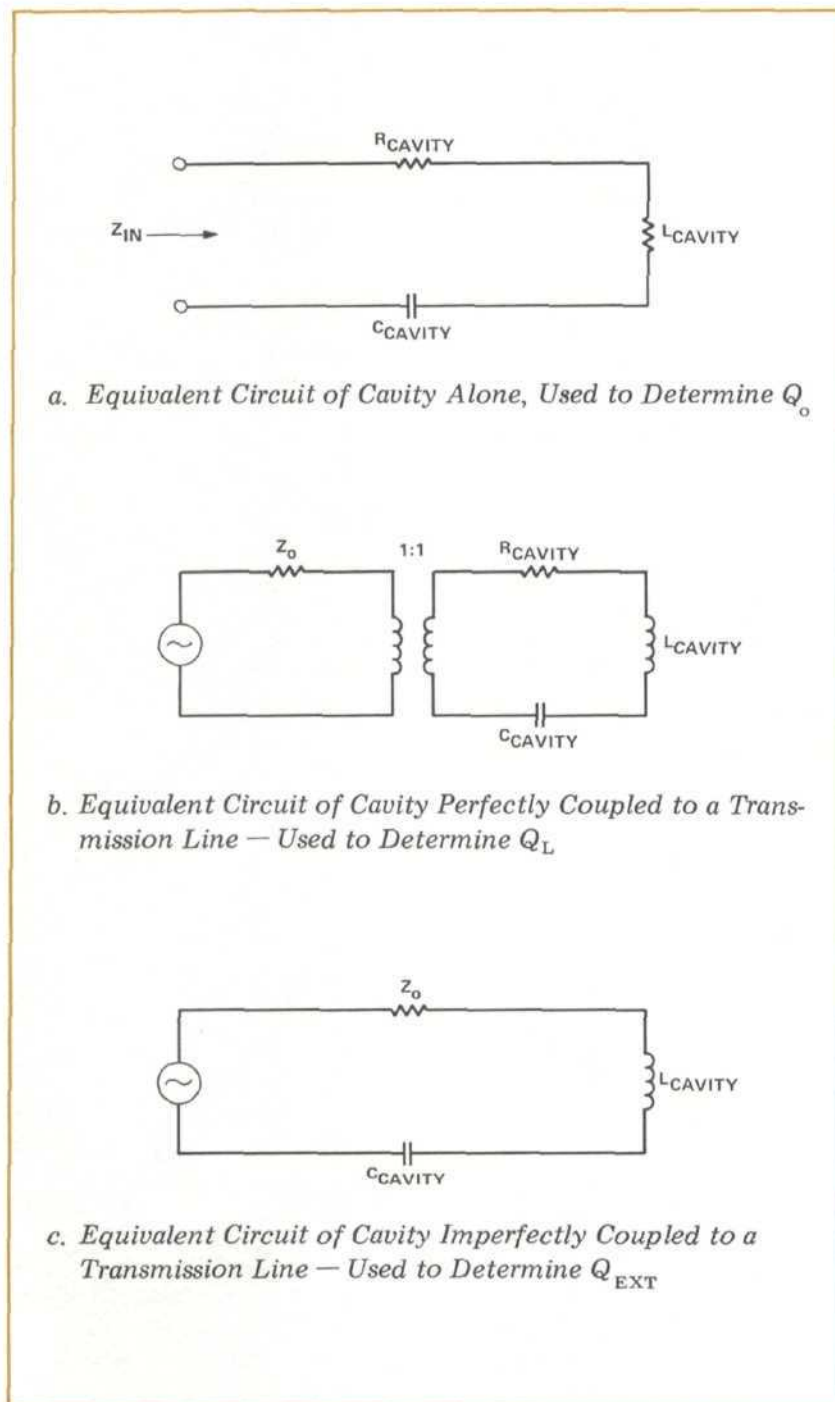

Figure 8-12. Cavity Equivalent Circuits

²For a more complete treatment of this subject refer to "Microwave Measurements," Edward L. Ginzton, McGraw-Hill Book Co., Inc. N.Y. 1957. Chapters 7 and 9.

These parameters are defined as:

Q_o — selectivity factor of the cavity dependent on the geometrical proportions of the cavity

$$Q_o = 2\pi \frac{\text{energy stored}}{\text{energy lost per cycle}}$$

Q_L — The Q of the entire system, including all sources of energy loss.

Q_{EXT} — The Q of the external system, i.e., the losses are due to the external load only, since the cavity is assumed to have no Q of its own ($R = 0$).

The specially scribed overlay is constructed in the following manner.

1. Q_o Arcs:

These arcs connect the half power points on the Smith Chart, i.e., the points at which $R_{CAVITY} = \pm X_{CAVITY}$.

Thus, center the arc at

$$Z = 0 \pm j1$$

with the radius established by the distance to the point

$$Z = 0 \pm j0$$

2. Q_L Segments:

These segments connect the points

$$Z = 0 \pm j0$$

and

$$Z = 0 \pm j1$$

and describe the half power (3 dB) points, i.e., the points at which $X_{CAVITY} = \text{Total Resistance of the Cavity and Transmission line, i.e., } R_{CAVITY} + Z_o$

3. Q_{EXT} Arcs:

These arcs are centered at the intersection of the tangents to the Smith Chart at $Z = 0 \pm j0$ and $Z = 0 \pm j1$ with a radius equal to the value such that the arcs go through these points. These arcs describe the half-power (3 dB) points at which $X_{CAVITY} = Z_o$.

These arcs and lines can be scribed on existing Smith Chart overlays for the 8414A Polar Display in a matter of minutes.

These Q parameters can then quickly be determined by identifying the frequency f_o with a marker or trace brightening, setting the CW mode of the sweep oscillator to this frequency and then switching the sweep mode to Δf . The resulting display can be expanded or contracted until it touches the desired set of Q loci.

This parameter is then determined by the formula:

$$Q = f_o / \Delta f$$

Δf is the 3 dB bandwidth

e.g., in Figure 8-13,

$$Q_{EXT} = f_o / (f_3 - f_4)$$

$$Q_L = f_o / (f_1 - f_2)$$

$$Q_o = f_o / (f_5 - f_6)$$

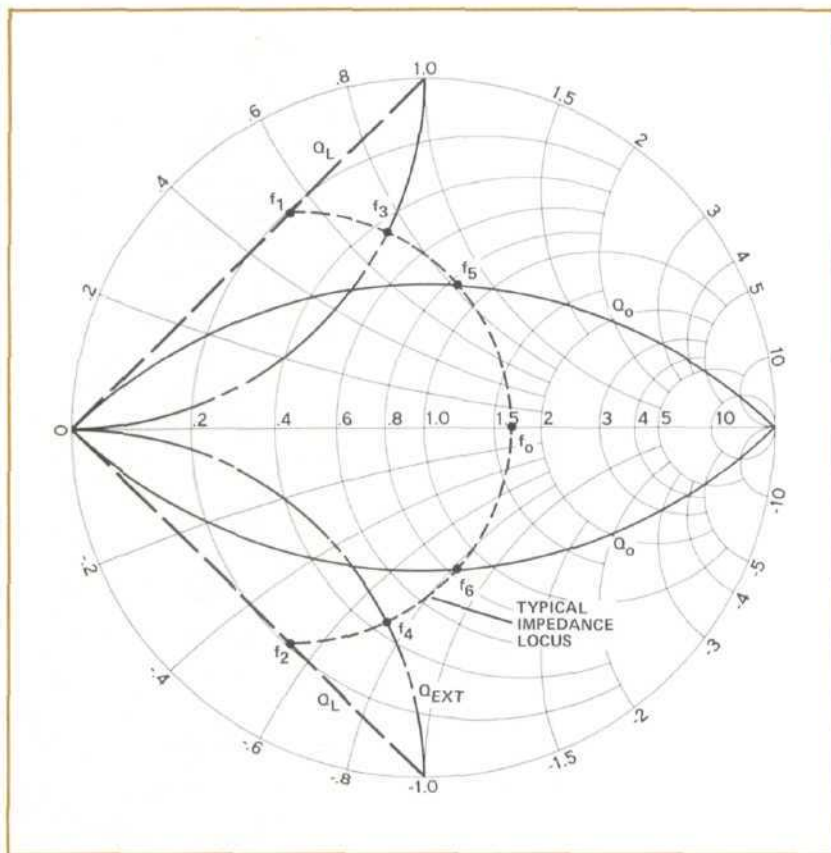
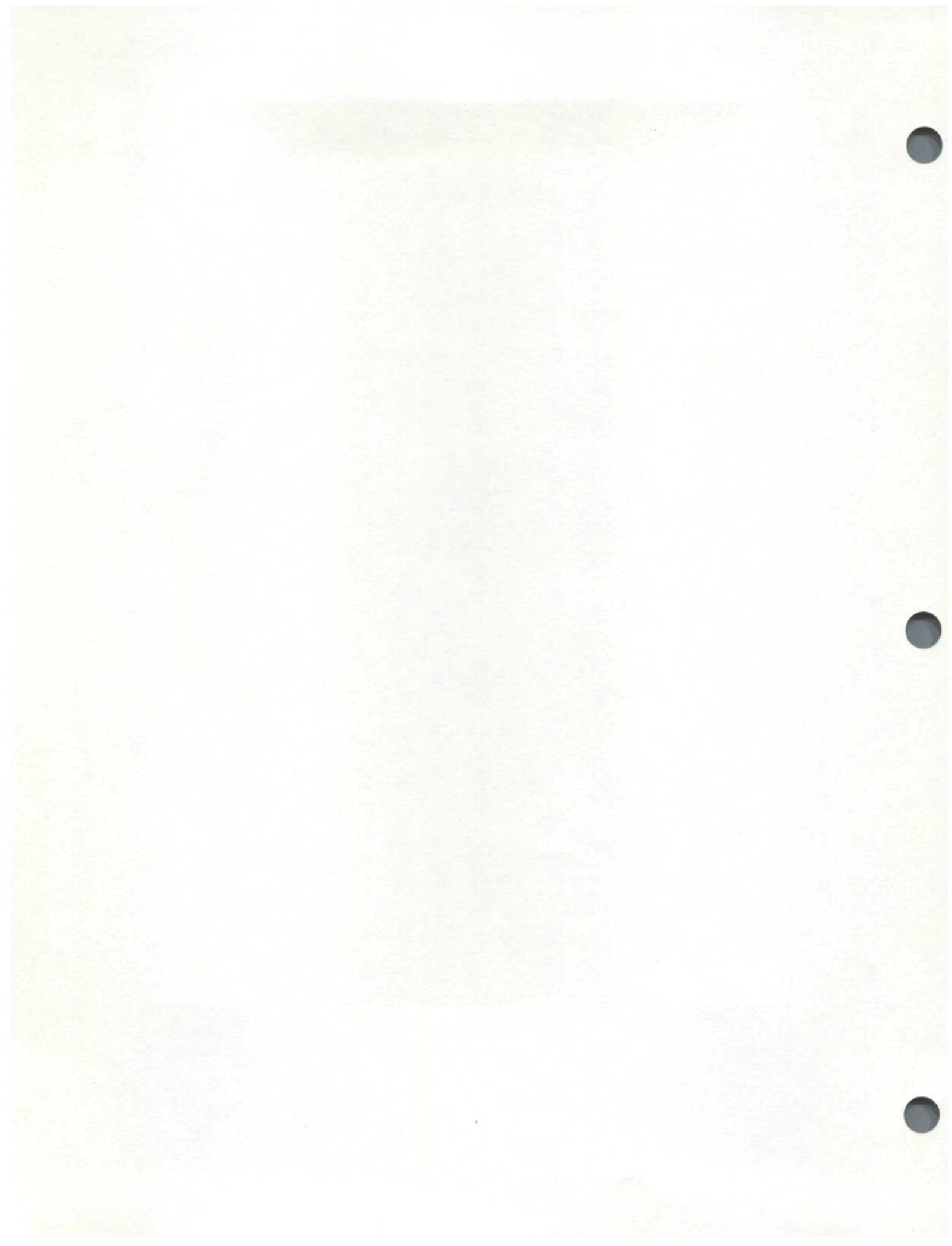

Figure 8-13. Loci of Q_o , Q_L , Q_{EXT}



APPENDIX I
CONVERSION EQUATIONS BETWEEN
Z, Y, H and S PARAMETERS
(NORMALIZED TO Z_0)

$$s_{11} = \frac{(z_{11} - 1)(z_{22} + 1) - z_{12} z_{21}}{(z_{11} + 1)(z_{22} + 1) - z_{12} z_{21}} \quad z_{11} = \frac{(1 + s_{11})(1 - s_{22}) + s_{12} s_{21}}{(1 - s_{11})(1 - s_{22}) - s_{12} s_{21}}$$

$$s_{12} = \frac{2z_{12}}{(z_{11} + 1)(z_{22} + 1) - z_{12} z_{21}} \quad z_{12} = \frac{2s_{12}}{(1 - s_{11})(1 - s_{22}) - s_{12} s_{21}}$$

$$s_{21} = \frac{2z_{21}}{(z_{11} + 1)(z_{22} + 1) - z_{12} z_{21}} \quad z_{21} = \frac{2s_{21}}{(1 - s_{11})(1 - s_{22}) - s_{12} s_{21}}$$

$$s_{22} = \frac{(z_{11} + 1)(z_{22} - 1) - z_{12} z_{21}}{(z_{11} + 1)(z_{22} + 1) - z_{12} z_{21}} \quad z_{22} = \frac{(1 + s_{22})(1 - s_{11}) + s_{12} s_{21}}{(1 - s_{11})(1 - s_{22}) - s_{12} s_{21}}$$

$$s_{11} = \frac{(1 - y_{11})(1 + y_{22}) + y_{12} y_{21}}{(1 + y_{11})(1 + y_{22}) - y_{12} y_{21}} \quad y_{11} = \frac{(1 + s_{22})(1 - s_{11}) + s_{12} s_{21}}{(1 + s_{11})(1 + s_{22}) - s_{12} s_{21}}$$

$$s_{12} = \frac{-2y_{12}}{(1 + y_{11})(1 + y_{22}) - y_{12} y_{21}} \quad y_{12} = \frac{-2s_{12}}{(1 + s_{11})(1 + s_{22}) - s_{12} s_{21}}$$

$$s_{21} = \frac{-2y_{21}}{(1 + y_{11})(1 + y_{22}) - y_{12} y_{21}} \quad y_{21} = \frac{-2s_{21}}{(1 + s_{11})(1 + s_{22}) - s_{12} s_{21}}$$

$$s_{22} = \frac{(1 + y_{11})(1 - y_{22}) + y_{21} y_{12}}{(1 + y_{11})(1 + y_{22}) - y_{12} y_{21}} \quad y_{22} = \frac{(1 + s_{11})(1 - s_{22}) + s_{12} s_{21}}{(1 + s_{22})(1 + s_{11}) - s_{12} s_{21}}$$

$$s_{11} = \frac{(h_{11} - 1)(h_{22} + 1) - h_{12} h_{21}}{(h_{11} + 1)(h_{22} + 1) - h_{12} h_{21}} \quad h_{11} = \frac{(1 + s_{11})(1 + s_{22}) - s_{12} s_{21}}{(1 - s_{11})(1 + s_{22}) + s_{12} s_{21}}$$

$$s_{12} = \frac{2h_{12}}{(h_{11} + 1)(h_{22} + 1) - h_{12} h_{21}} \quad h_{12} = \frac{2s_{12}}{(1 - s_{11})(1 + s_{22}) + s_{12} s_{21}}$$

$$s_{21} = \frac{-2h_{21}}{(h_{11} + 1)(h_{22} + 1) - h_{12} h_{21}} \quad h_{21} = \frac{-2s_{21}}{(1 - s_{11})(1 + s_{22}) + s_{12} s_{21}}$$

$$s_{22} = \frac{(1 + h_{11})(1 - h_{22}) + h_{12} h_{21}}{(h_{11} + 1)(h_{22} + 1) - h_{12} h_{21}} \quad h_{22} = \frac{(1 - s_{22})(1 - s_{11}) - s_{12} s_{21}}{(1 - s_{11})(1 + s_{22}) + s_{12} s_{21}}$$

In addition to these transformation equations, it may be more convenient for the user of the S-parameters to convert these to y, z, or transmission parameters by a matrix transformation.

The following equations are given for this purpose:

TWO PORT PARAMETER TRANSFORMATIONS:

s parameters and y parameters

$$Y = (U - S) (U + S)^{-1}$$

$$S = (U - Y) (U + Y)^{-1}$$

s parameters and z parameters

$$Z = (U + S) (U - S)^{-1}$$

$$S = (Z - U) (Z + U)^{-1}$$

where U stands for Identity
(Unit) matrix

s parameters and t (transmission)
parameters

$$T = \begin{pmatrix} -\frac{(S_{11} S_{22} - S_{12} S_{21})}{S_{21}} & \frac{S_{11}}{S_{21}} \\ -\frac{S_{22}}{S_{21}} & \frac{1}{S_{21}} \end{pmatrix}$$

$$S = \begin{pmatrix} \frac{T_{12}}{T_{22}} & \frac{T_{11} T_{22} - T_{12} T_{21}}{T_{22}} \\ \frac{1}{T_{22}} & -\frac{T_{21}}{T_{22}} \end{pmatrix}$$

APPENDIX II
BASIC BLOCK DIAGRAMS

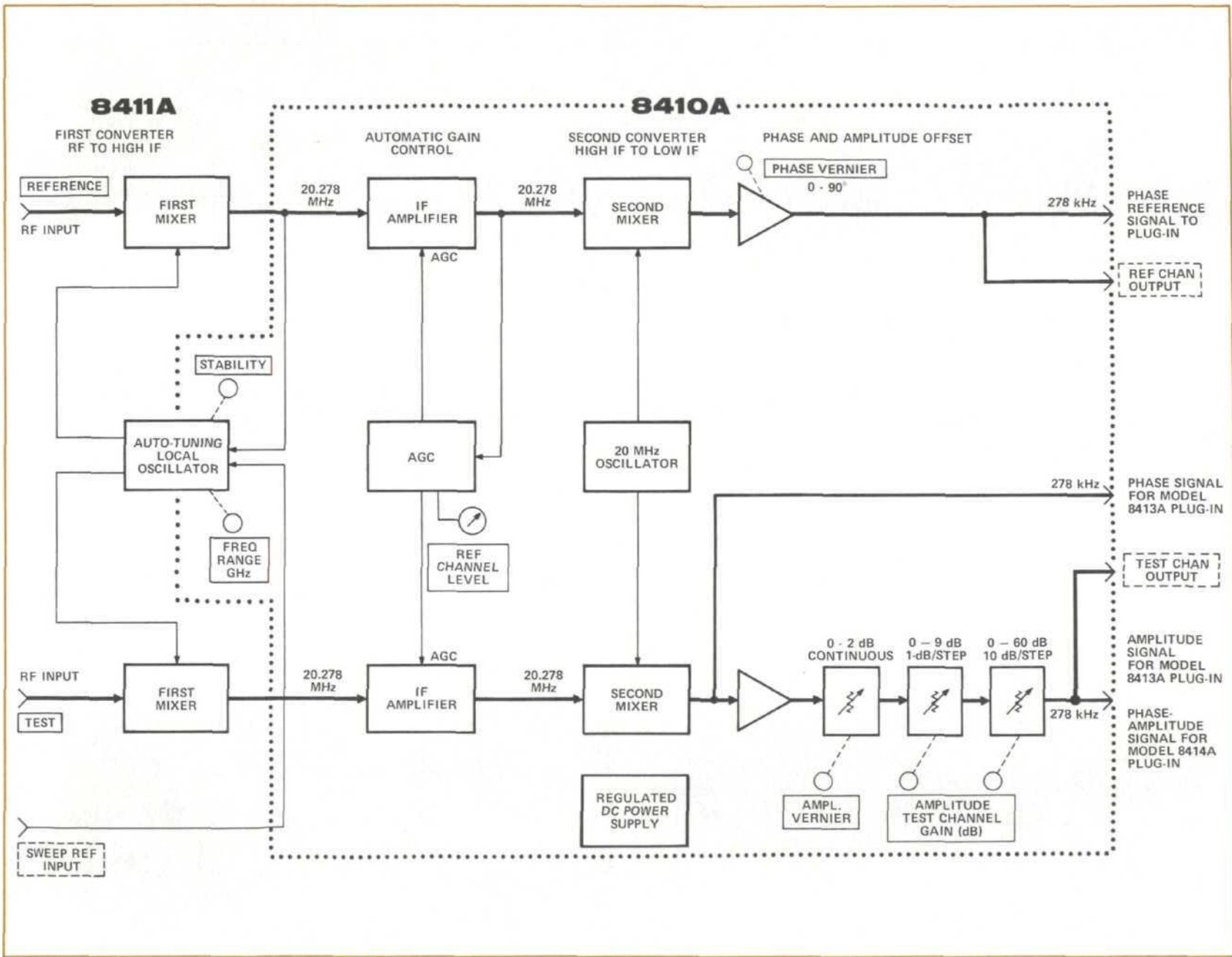

Model 8410/8411A Basic Block Diagram

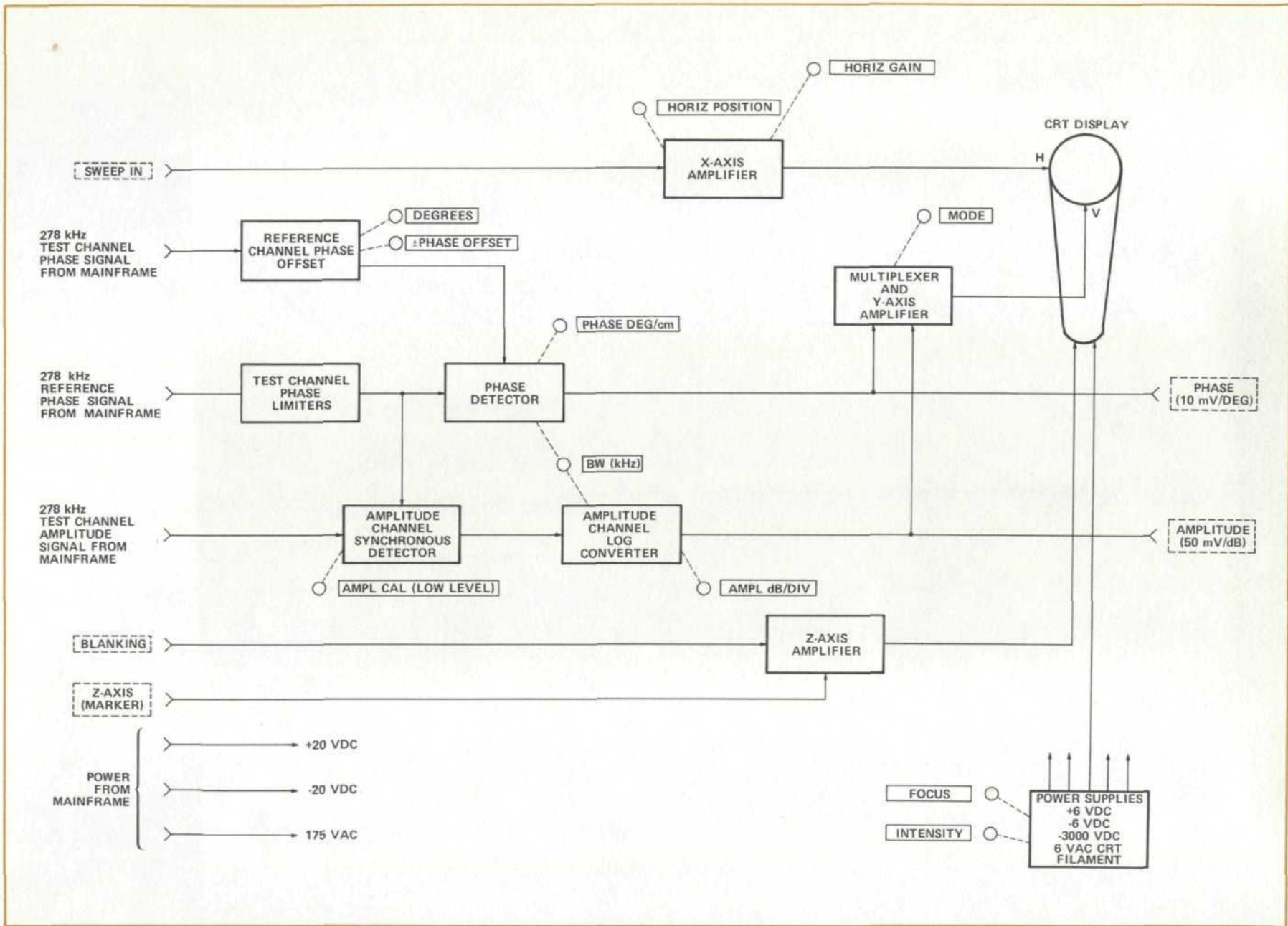

Model 8412A Simplified Block Diagram

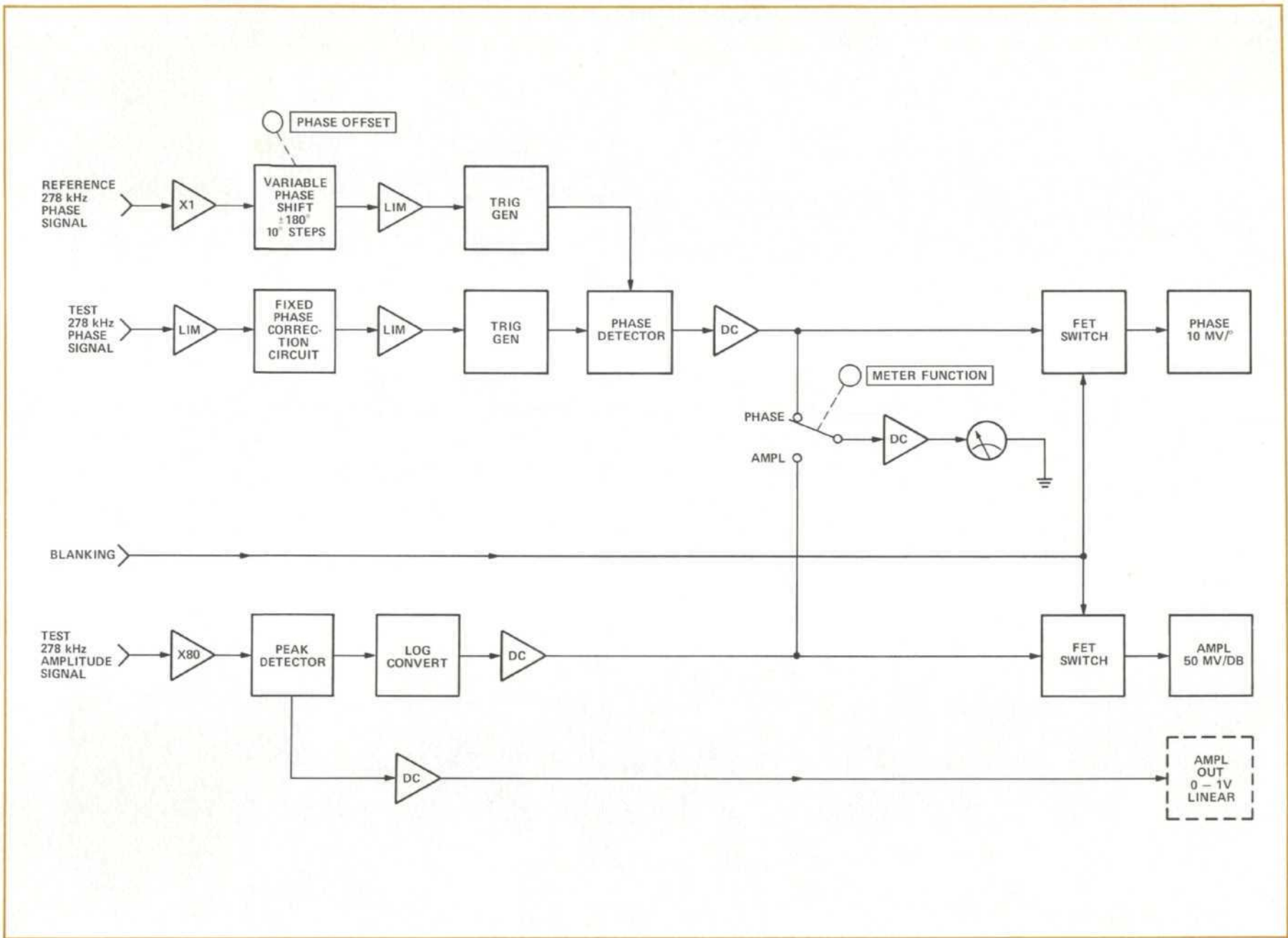

Model 8413A Phase-Gain Indicator, Simplified Block Diagram

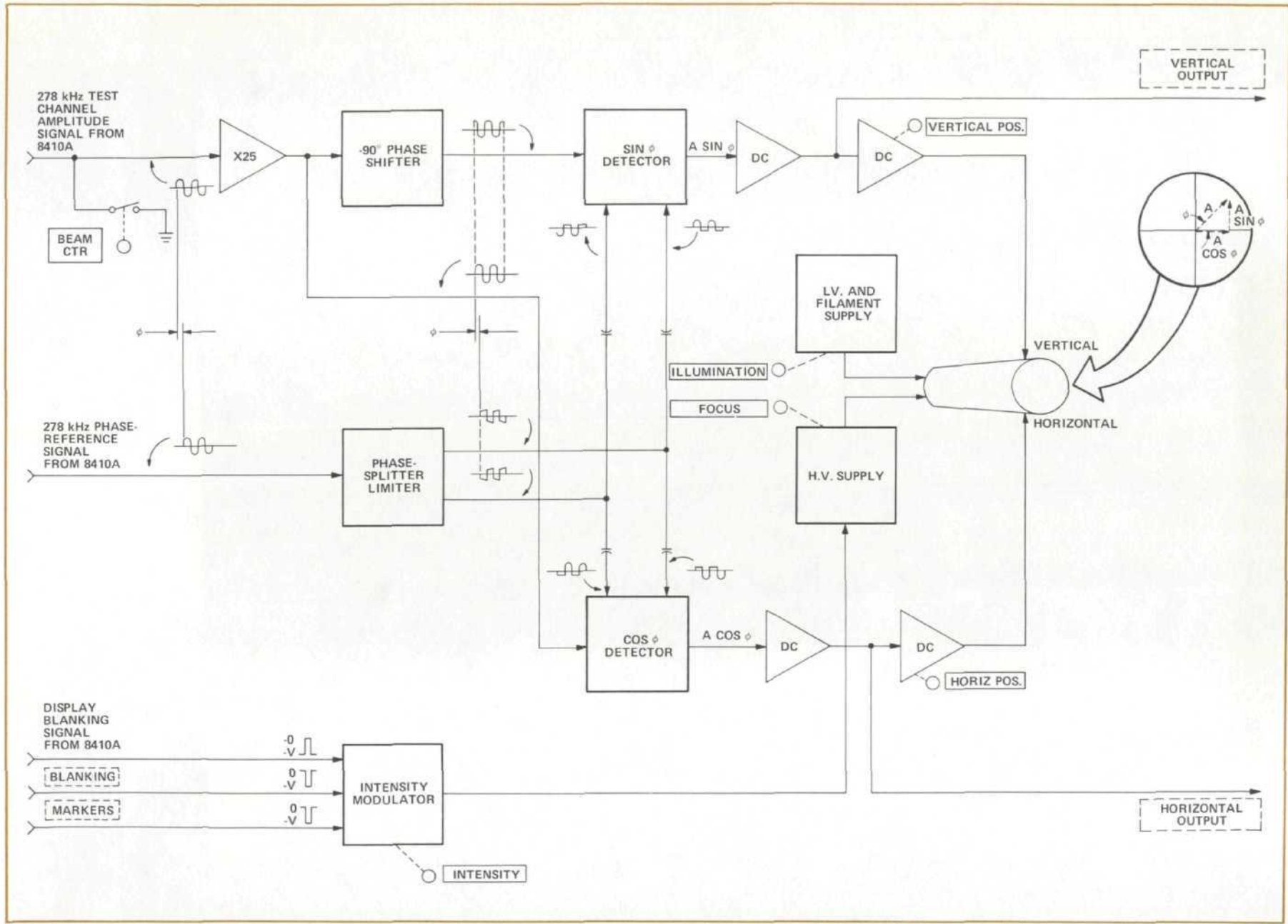

Model 8414A Polar Display, Overall Block Diagram

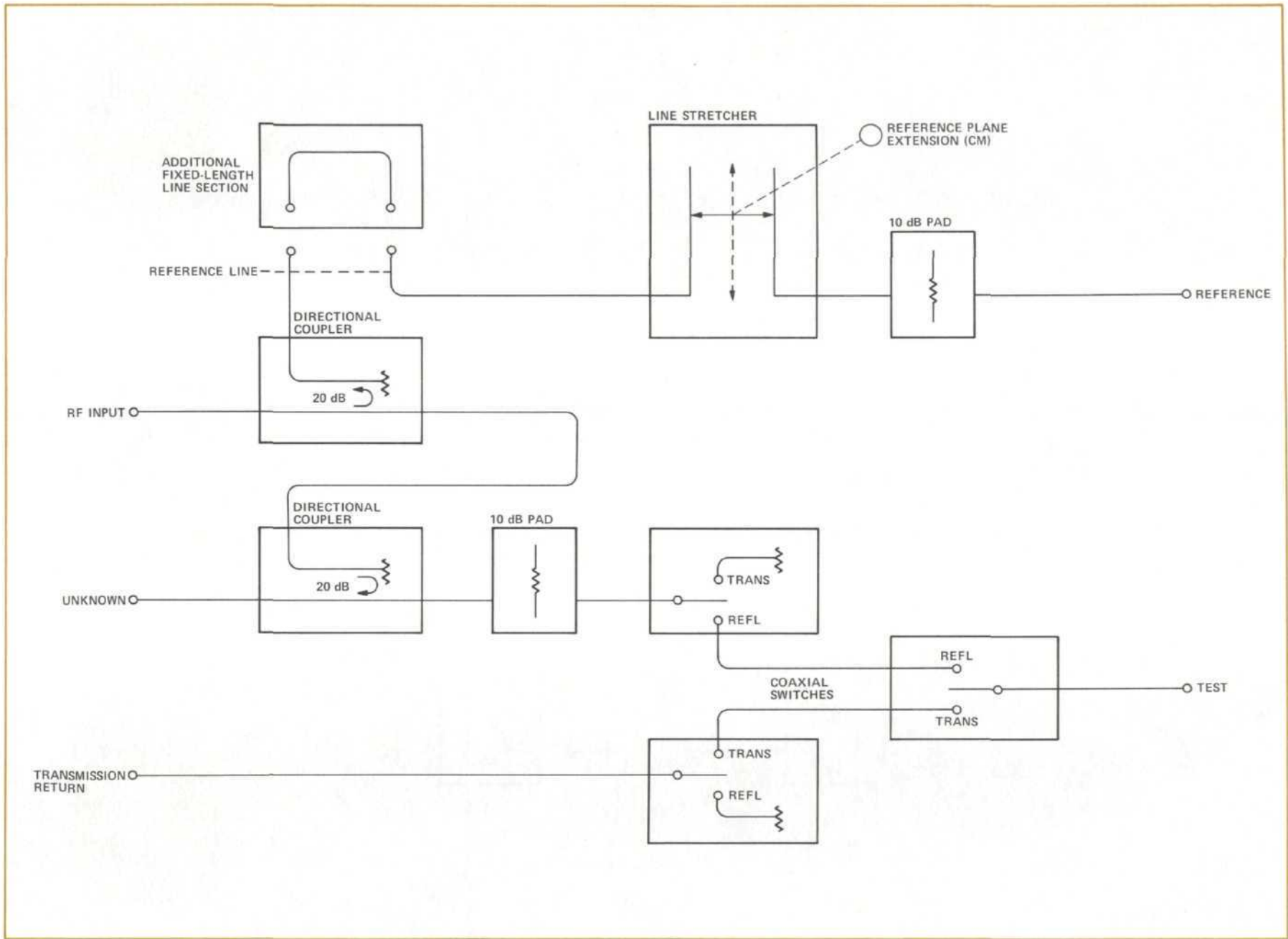

Model 8743A Simplified RF Schematic Diagram

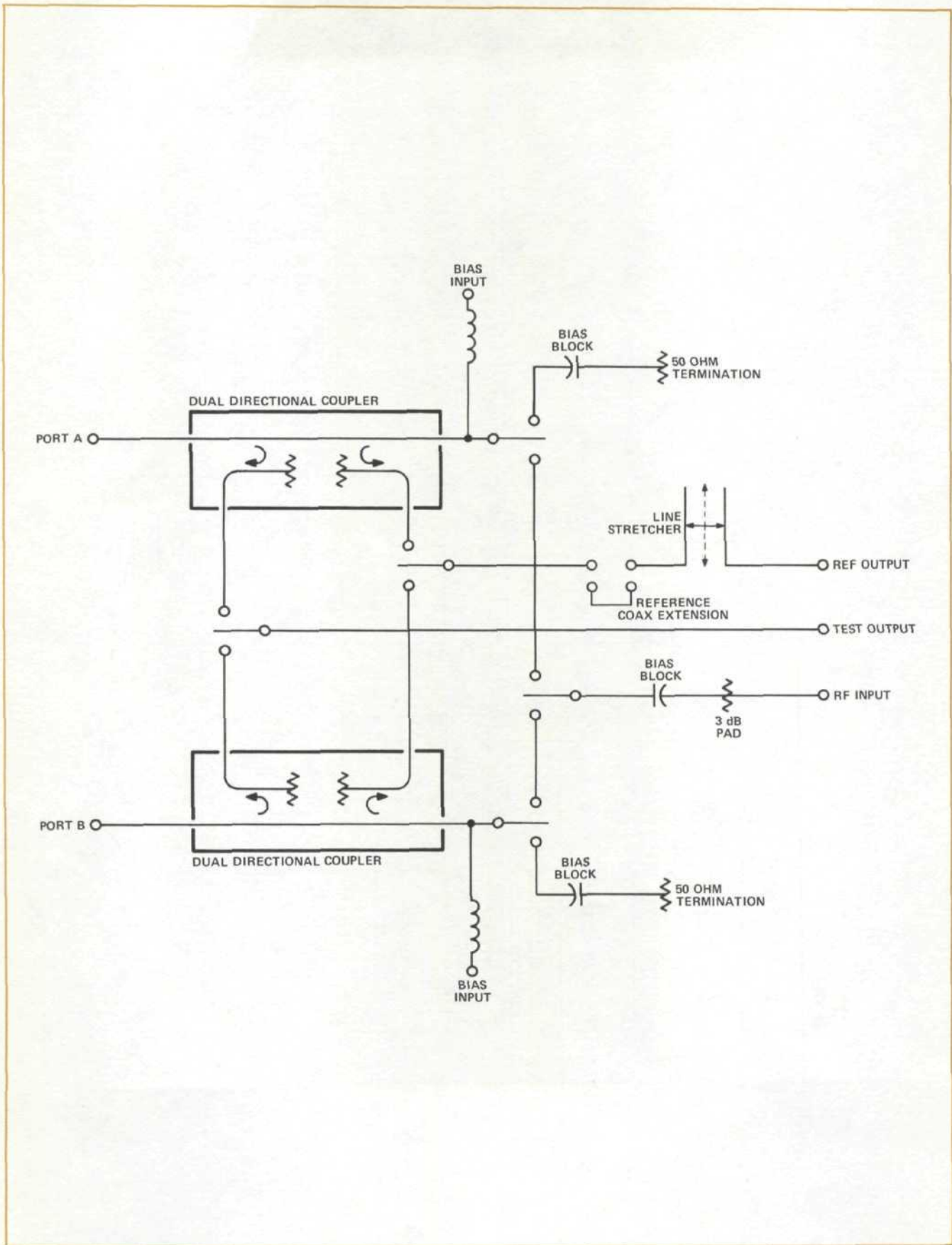

Model 8745A Simplified Schematic Diagram, RF Section

APPENDIX III

RECOMMENDATIONS ON HANDLING AND CARE OF APC-7 CONNECTORS

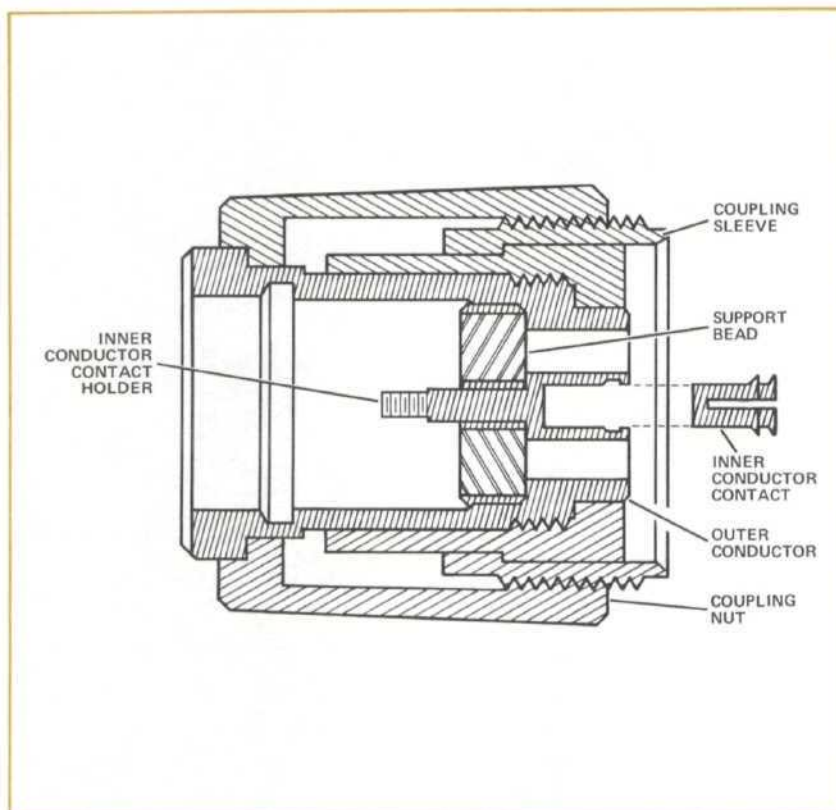

USE

To Connect:

1. On one connector, retract the coupling sleeve by turning the coupling nut counterclockwise until the sleeve and nut disengage.
2. On the other connector, fully extend the coupling sleeve by turning the coupling nut clockwise. To engage coupling sleeve and coupling nut when the sleeve is fully retracted, press back lightly on the nut while turning it clockwise.
3. Push the connectors firmly together, and thread the coupling nut of the connector with retracted sleeve over the extended sleeve. Leave the other coupling nut in the original position: closing the gap between coupling nuts tends to loosen the electrical connection.

To Disconnect:

1. Loosen the coupling nut of the connector showing the wider gold band.

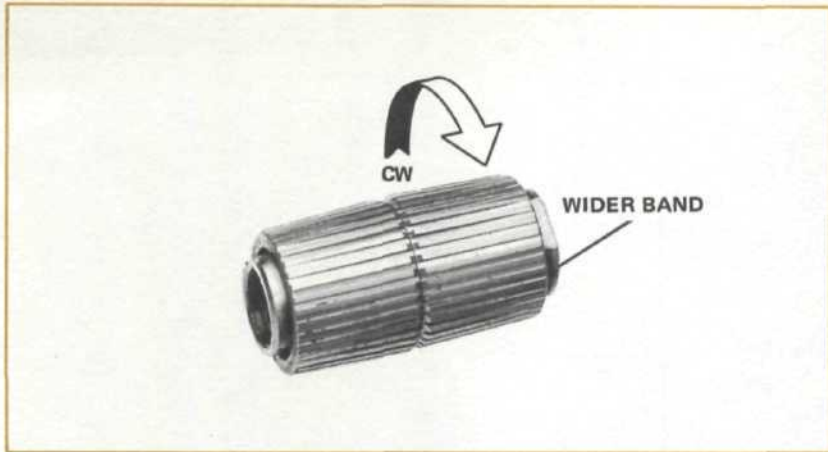

2. **IMPORTANT:** Part the connectors carefully to prevent striking the inner conductor contact.

CARE

1. Keep contacting surfaces smooth and clean. Irregularities and foreign particles can degrade electrical performance.

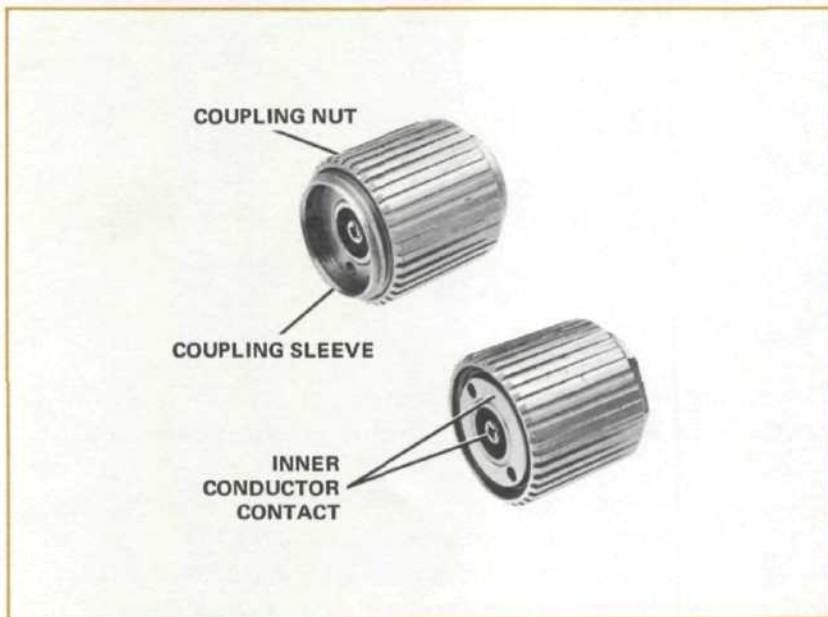

2. Protect the contacting surfaces when the connector is not in use by leaving the coupling sleeve extended.
3. Use lintless material and/or firm-bristled brush such as tooth brush for cleaning. If a cleaning fluid is needed use isopropyl alcohol. **IMPORTANT:** Do not use aromatic or chlorinated hydrocarbons, esters, ethers, terpenes, higher alcohols, ketones, or ether-alcohols such as benzene, toluene, turpentine, dioxane, gasoline, cellosolve acetate, or carbon tetrachloride. Keep exposure of the connector parts to both the cleaning fluid and its vapors as brief as possible.

BIBLIOGRAPHY

The publications listed merely represent a cross section of available sources of information, and is not intended to be complete. The Hewlett-Packard Application Notes are available upon request from the local sales office.

BOOKS

Adam, Stephen, *Microwave Theory and Applications*, Prentice-Hall, Inc., Englewood Cliffs, N.J., 1964. 513 pp.

Ginzton, Edward L., *Microwave Measurements*, McGraw-Hill Book Co., Inc., New York, N.Y., 1957. 515 pps.

Smith, Phillip H., *Electronic Applications of the Smith Chart*, McGraw-Hill Book Co., Inc., New York, N.Y., 1969. 222 pp.

PERIODICALS

Proceedings of the IEEE, June 1967. Special issue on "Radio Measurement Methods and Standards".

Hewlett-Packard Journal issues of interest:

1. February, 1967. Issue devoted to the 8410A Network Analyzer and S-Parameters.
2. January, 1969. Issue partially devoted to the 8410A Network Analyzer's components.

HP APPLICATION NOTES

AN 77-1	Transistor Parameter Measurements
AN 77-3	Complex Impedance Measurements
AN 91	How Vector Measurements Expand Design Capabilities -1 to 1,000 MHz
AN 95-1	S-Parameter Techniques For Faster, More Accurate Network Design
AN 117-2	Stripline Component Measurements With the 8410A Network Analyzer
AN 154	S-Parameter Design
AN 187-3	Three HP-IB Configurations For Making Scalar Measurements
AN 221	Semi-Automatic Measurements Using the 8410B Microwave Network Analyzer and the 9825A Desktop Computer

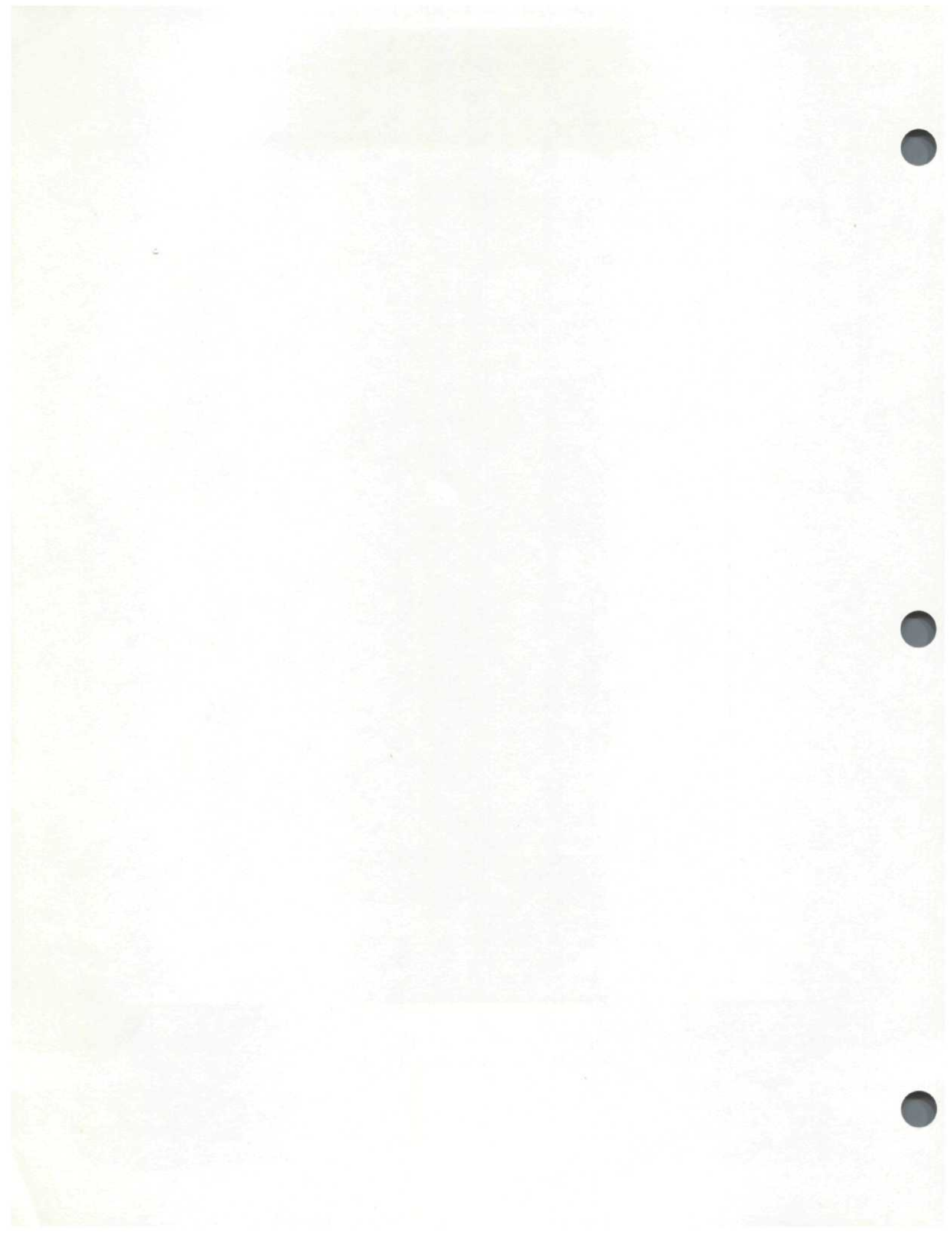

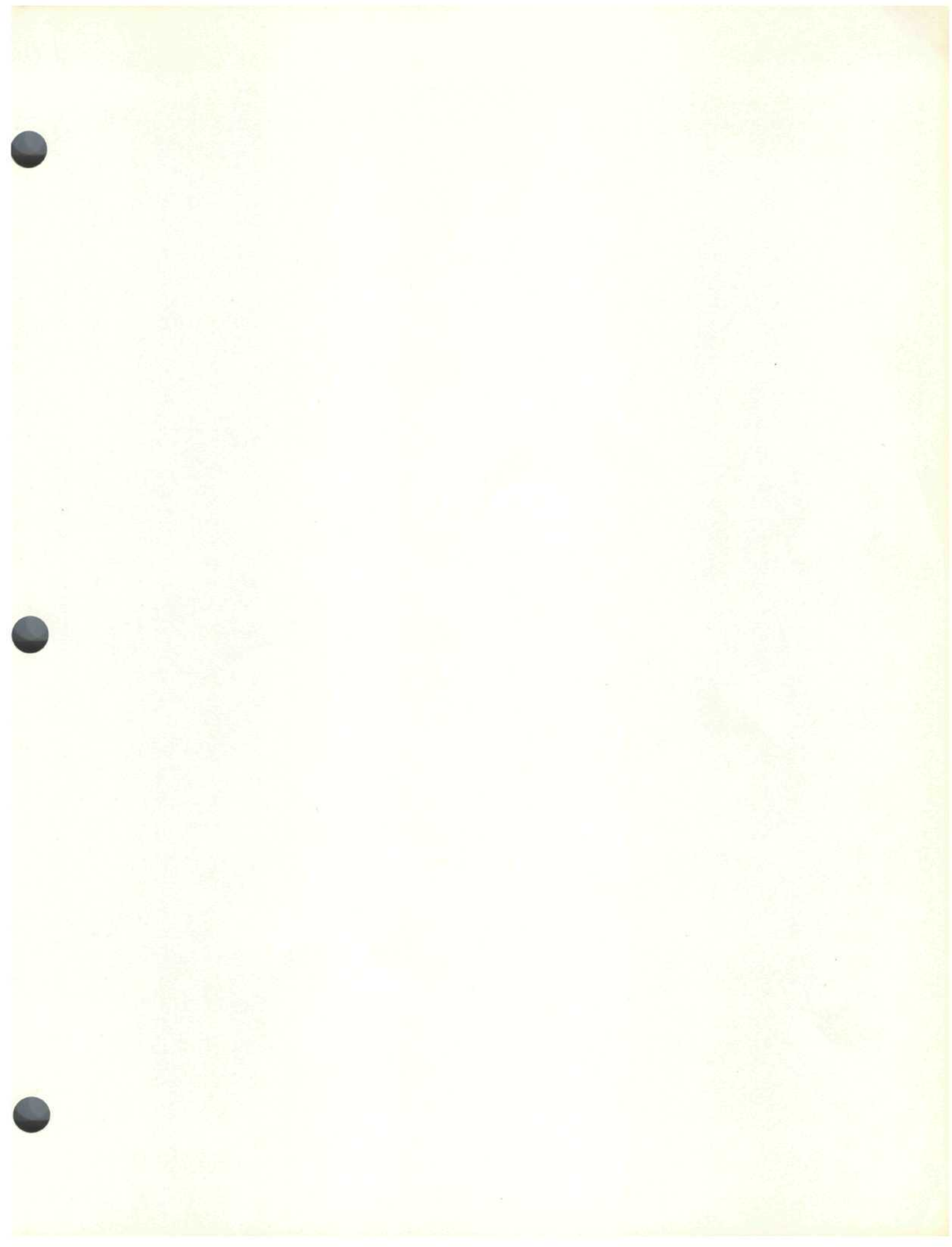

HEWLETT  PACKARD