

High-Accuracy Noise Figure Measurements Using the PNA-X Series Network Analyzer

Application Note

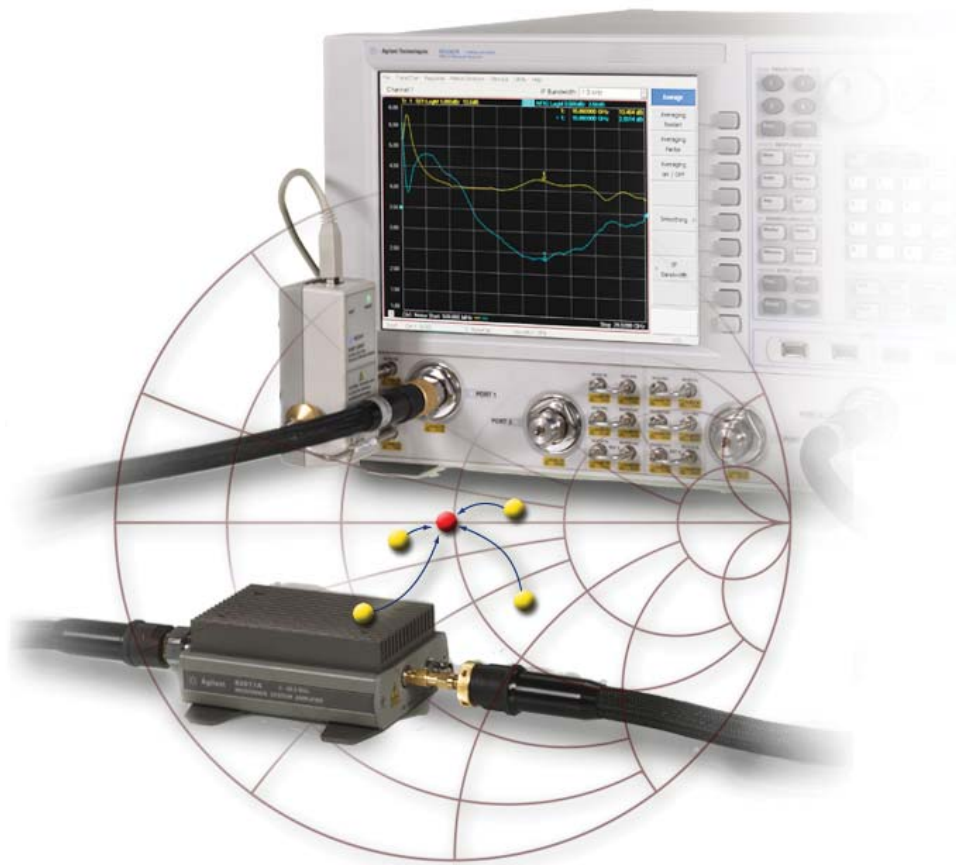

Agilent Technologies

Table of Contents

Overview of Noise Figure	3
What is noise figure?	3
Importance of noise figure accuracy	5
Noise Figure Measurement Techniques	6
Y-factor method	7
Cold source method	8
Accuracy Limitations	9
Assumptions of the Y-factor method	9
Noise figure measurement uncertainty contributions	10
PNA-X's Unique Approach	19
Option choices	19
Correcting for noise-parameter effects	21
Measurement comparisons of PNA-X and Y-factor method	23
Scalar noise calibration	30
Sweep considerations	31
Using the standard receivers for measuring noise figure	32
Noise-power parameters	38
Measuring frequency converters	38
Measuring differential devices	40
Measuring noise parameters	42
Calibration Overview	43
Vector noise calibration	43
Standard receiver noise calibration	45
Scalar noise calibration	46
Calibration for frequency converters	46
On-wafer calibration	47
Moving the noise calibration plane	49
Practical Measurement Considerations	50
Ambient temperature setting	50
Noise averaging	50
Optimizing S-parameter power level	54
Optimizing power sensor level during calibration	55
Compression and damage levels	56
Interference	58
Additional Resources	59
Application notes	59
Magazine articles	59
Papers	59
Web	59

Overview of Noise Figure

What is noise figure?

Noise figure is a figure-of-merit that describes the amount of excess noise present in a system. Minimizing noise figure reduces system impairments that result from noise. In our personal lives, noise degrades the image quality of TV pictures, and adversely impacts the voice quality of cell phone calls. In military applications like radar, receiver noise limits the effective range of the system. With digital communications, noise increases the bit-error rate. System designers always try to optimize the overall signal-to-noise ratio (SNR) of the system. This can be done by increasing the signal, or by reducing noise. In a transmit/receive system like a radar system, one possibility is to increase the radar's transmitted power by using bigger, more powerful amplifiers, and/or by using larger antennas. Decreasing the path loss between the transmitter and receiver also helps increase SNR, but path loss is often defined by the operating environment and cannot be controlled by the system designer. SNR can also be increased by decreasing receiver-contributed noise, which is usually determined by the quality of the low-noise amplifier (LNA) at the front end of the receiver. In general, it is easier and less expensive to decrease receiver noise (and achieve a better noise figure) than to increase transmitter power.

The definition of noise figure is simple and intuitive. The noise factor (F) of a network is defined as the input SNR divided by the output SNR:

$$F = (S_i/N_i)/(S_o/N_o), \text{ where}$$

- S_i = input signal power
- S_o = output signal power
- N_i = input noise power
- N_o = output noise power

Noise figure (NF) is simply the noise factor expressed in decibels: $NF = 10 \cdot \log(F)$

This definition is true for any electrical network, including those that shift the frequency of the input signal to a different output frequency, such as an up or down converter.

To better understand the concept of noise figure, consider an amplifier where the output signal is equal to the input signal multiplied by the gain of the amplifier. If the amplifier is perfect, the output noise is also equal to the input noise multiplied by the amplifier's gain, resulting in the same SNR at both the input and output of the amplifier. For any real-world amplifier however, the output noise is larger than the input noise multiplied by the gain, so the SNR at the output is smaller than that at the input, resulting in F being greater than one, or NF being greater than 0 dB.

It is important to note that when measuring and comparing noise figures, the test system is assumed to provide perfect 50-ohm terminations at the input and output of the device-under-test (DUT). In real-world scenarios however, this is never the case. Later, we will discuss the accuracy implications if our test system is not exactly 50 ohms, and we will show how calibration and measurement methods can overcome the errors produced from an imperfect 50-ohm source match.

Another way to express the amount of noise added by an amplifier or system is in terms of effective input temperature (T_e). To understand this parameter, recall that the amount of noise available from a passive termination can be expressed as kTB , where k is Boltzmann's constant, T is the temperature of the termination in Kelvin, and B is the system bandwidth. For a given bandwidth, the amount of noise is proportional to temperature. Therefore, the amount of noise produced by a device can be expressed as an equivalent noise temperature, normalized to a 1 Hz bandwidth. For example, the amount of electrical noise coming out of a commercial noise source with a 15 dB excess-noise ratio (ENR) is equivalent to a termination at 8880 K. The noise factor of any real device can be expressed as an effective input noise temperature. While T_e is not the actual physical temperature of the amplifier or converter, it is the equivalent temperature (in degrees Kelvin) of an input termination connected to a perfect (noise-free) device that would produce the same amount of additional noise at the output. T_e is related to the noise factor as:

$$T_e = 290 * (F - 1)$$

A plot of T_e versus noise figure is shown in Figure 1. While the majority of LNAs are described using noise figure, T_e is often used for LNAs that have noise figures that are less than 1 dB. T_e is also useful for mathematical calculations involving noise powers.

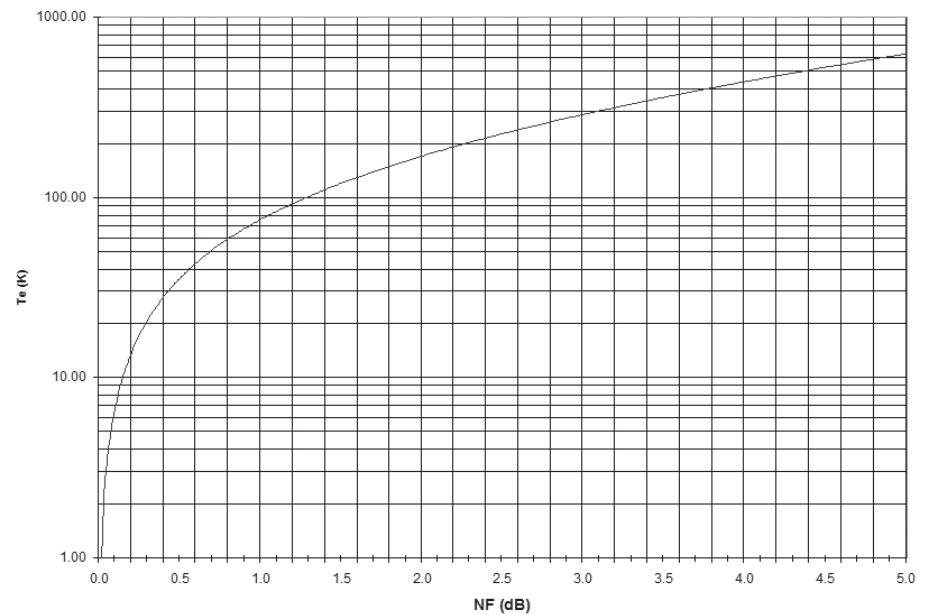

Figure 1. Effective noise temperature versus noise figure

Importance of noise figure accuracy

One of the goals of this application note is to give the reader a better understanding of accuracy issues related to noise figure measurements. Measurement accuracy is important in both R&D and manufacturing environments. In R&D, better noise figure accuracy means that there will be a better correlation between simulations and measurements, helping designers refine circuit models faster. But higher accuracy also means that a system designer can better optimize transmit/receive systems like those used in radar applications. When assigning performance values to all of the individual components of the system, the system designer must add a guard band based on measurement accuracy, since a component designer will measure their device to verify its performance. For noise figure, improved measurement accuracy and smaller guard bands mean the LNA can have better specifications, which in turn means that lower-power transmit amplifiers can be used for the same overall system SNR. This translates to smaller, lighter, and cheaper transmitters, all of which is very important for airborne and spaceborne applications.

In manufacturing, improved measurement accuracy also allows use of smaller guard bands, which provides better correlation among multiple test stations. This means fewer products must be reworked, resulting in higher yields and improved throughput, and lower test costs. Smaller guard bands also allow better device specifications, yielding more competitive products that command higher prices or attain higher market share.

Noise Figure Measurement Techniques

There are two main techniques for making noise figure measurements. The most commonly used method is called the Y-factor or hot/cold-source technique, and it is used with Agilent’s noise figure analyzers, and spectrum analyzer-based solutions.

The Y-factor method uses a calibrated noise source consisting of a specially designed noise diode that can be turned on or off, followed by an attenuator to provide a good output match (Figure 2). When the diode is off (i.e., no bias current is present), the noise source presents a room-temperature termination to the DUT. When the diode is reversed biased, it undergoes avalanche breakdown, which creates considerable electrical noise over and above that provided by a room-temperature termination. This amount of extra noise is characterized as an “excess noise ratio” or ENR, and for a given noise source, ENR varies versus frequency. Typical noise sources have nominal ENR values that range from 5 dB to 15 dB, depending on the value of the internal attenuator. Using the noise source, two noise-power measurements are made at the output of the DUT, and the ratio of the two measurements, which is called the Y-factor, is used to calculate noise figure. The Y-factor method also yields the scalar gain of the DUT.

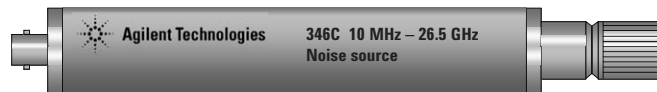

$$\text{Excess noise ratio (ENR)} = \frac{T_{\text{hot}} - T_{\text{cold}}}{290 \text{ K}}$$

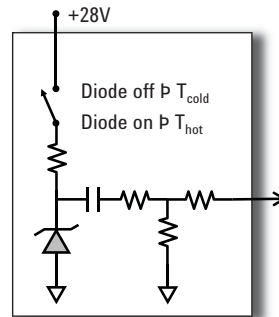

Figure 2. Schematic of an excess noise source

The second approach for measuring noise figure is the cold source method, which is also sometimes called the direct-noise method. It relies on a single, cold (typically room temperature) termination at the input of the DUT, and an independent measurement of the DUT’s gain. This method is often used with vector network analyzers (VNAs), because multiple measurements, such as S-parameters, compression, and noise figure, can be performed on an amplifier or converter with a single set of connections.

Y-factor method

Let's take a closer look at the Y-factor technique. Using the noise source, two noise-power measurements are made. One measurement is made with the noise source in its cold state (noise diode off) and the other measurement is made with the noise source in its hot state (noise diode on). From these two measurements, and from knowing the ENR values of the noise source, two variables can be calculated: the scalar gain and the noise figure of the amplifier under test.

When the DUT is measured, the noise contribution of the test instrument's noise receiver is also measured. To remove the effects of this additional noise, a calibration step is done prior to the actual measurement, where the noise source is connected to the test instrument to determine the noise figure of the internal noise receiver. A simple mathematical expression can be used to extract the noise figure of the DUT from the overall system noise measurement. This step is referred to as second-stage noise correction, as the DUT's measured noise figure is corrected based on the gain and noise figure of a second stage, which in this case is the test instrument's noise receiver.

If the output noise power of an amplifier is plotted versus input noise, it follows a straight line as shown in Figure 3, as long as the amplifier is linear. This is a good assumption for LNAs, since their purpose is to amplify low-level signals that are far from the amplifier's compression region. If the input noise was zero, there would still be some noise coming out of the amplifier, due to noise generation processes within the amplifier's active circuitry. This amplifier-generated noise is what is characterized with a noise figure measurement. Graphically, it is easy to see why two measurements of noise power can be used to solve both the amplifier's gain (the slope of the line) and the noise figure (derived from the Y-intercept point).

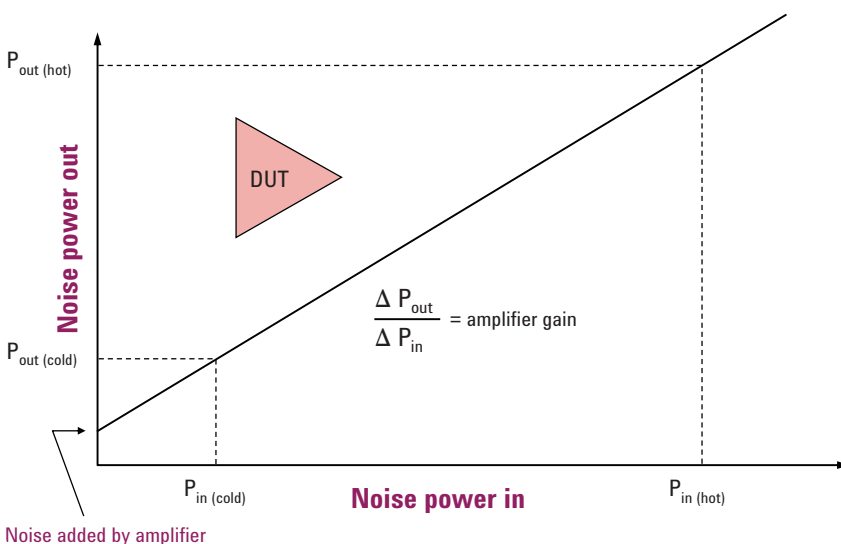

Figure 3. Graphical representation of Y-factor method

Cold source method

Let's now take a closer look at the cold-source technique. This method is very simple in concept. A room temperature (the so-called "cold" termination) is placed on the DUT's input, and a single noise power measurement is made. The noise measured is due to the amplified input noise plus the noise contributed by the amplifier or converter. If the gain of the amplifier (or conversion gain of the converter) is accurately known, then the amplified input noise can be subtracted from the measurement, leaving only the noise contributed by the DUT. From this, noise figure can be calculated. In order to achieve accurate cold-source measurements, the gain of the DUT must be known with a high degree of precision. A vector network analyzer can provide the necessary level of precision using two-port vector-error correction and other advanced calibration methods. Therefore, the cold-source method lends itself well to a vector network analyzer-based solution.

Just as was done with the Y-factor method, a calibration step is required to characterize the noise figure and gain of the instrument's noise receivers. This can be accomplished using a noise source, as is done with the Y-factor method, or by using a power meter and a frequency sweep to determine the receiver's effective noise bandwidth. Note that a noise source or power meter is **ONLY** used during calibration with the cold-source method, and not during the measurement of the DUT.

Figure 4 shows a graphical representation of output versus input noise power. In this case, the slope of the line is known from an independent gain measurement of the DUT. To define the line, only one power measurement is needed to establish the Y-intercept point, which allows derivation of the noise figure of the DUT.

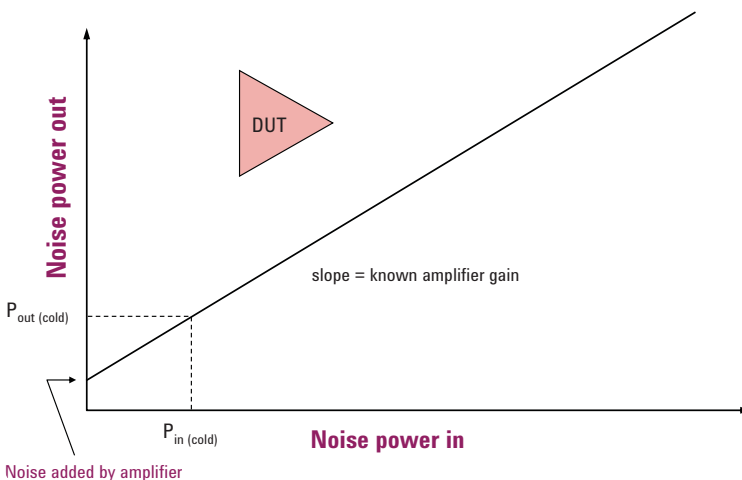

Figure 4. Graphical representation of cold-source method

Note that when using a VNA, vector-error correction can be used when measuring the gain of the DUT, which gives a more accurate value than that obtained from the Y-factor method. Vector-error correction requires that all four S-parameters of the DUT are measured, which requires two sweeps of the analyzer (forward and reverse). The corrected values for S_{11} and S_{22} of the DUT are used to correct for other errors in the measurement, as discussed later. An adaptation of this approach has been developed for measuring frequency converters, where the input and output frequencies are different.

Accuracy Limitations

Assumptions of the Y-factor method

The accuracy of the Y-factor method relies on several assumptions about the amplifier and the test system. The validity of these assumptions varies, depending on the S-parameters and noise parameters of the test system and the DUT.

The first assumption is that the noise source presents a good 50-ohm match to the DUT. This is a reasonable (but not perfect) assumption when the noise source is connected directly to the DUT, especially when using low-ENR noise sources which tend to have better match than high-ENR sources. However, this is usually not a good assumption when an electrical network is present between the noise source and the DUT. The deviation from a perfect 50-ohm source match can contribute a large amount of measurement error, as will be shown later.

There are several examples where it is impractical or impossible to connect the noise source directly to the input of the DUT. First of all, many devices used in aerospace/defense applications and commercial microwave communications are not connectorized. For example, many transmit/receive modules used in phased-array radar systems have microstrip input and output lines, requiring test fixtures to interface to commercial coaxial-based test equipment. Another example is that of microwave monolithic integrated circuits (MMICs), which are often tested while still on the wafer on which they were fabricated, before being sealed into hermetic packages. In this case, coaxial-to-coplanar test probes must be used to connect test equipment to the DUT. In both of these examples, the noise source cannot be connected directly to the DUT's input.

Even when the devices being tested have coaxial connectors, many times they are measured with automated test equipment (ATE), allowing the connection of multiple test instruments for full characterization of the DUT. For example, a network analyzer might be used to measure S-parameters and gain compression, while a spectrum analyzer is used in conjunction with signal generators and a noise source to measure intermodulation distortion and noise figure. In this scenario, a switch matrix is used between the test equipment and the DUT. Again, when measuring noise figure, the noise source cannot be connected directly to the input of the amplifier.

In these cases, when the noise source cannot be connected directly to the DUT's input, the addition of cables, adapters, switches, test fixtures, and/or probes adds loss, as well as extra reflections, which causes the effective source match of the test system to degrade. While the impact of loss can be mitigated by applying a scalar correction to the ENR values of the noise source, the effects of source-match degradation are not easily removed, causing a corresponding decrease in measurement accuracy.

The second assumption is that the output match of the noise source does not change between its hot and cold states. In reality, there will be some difference, since the impedance of the noise diode is different between its biased and unbiased conditions. This change is smaller for low-ENR noise sources, which have more attenuation between the diode and the output connector.

The third assumption is that the noise figure of the test instrument's noise receiver is the same when the noise source is connected and when the DUT is connected, even though those two devices will present different source impedances to the noise receiver. In actuality however, the noise parameters of the noise receiver will dictate how its noise figure changes with source impedance, which implies that the second-stage noise correction should be adjusted depending on S_{22} of the DUT.

The final assumption has to do with the available gain of the amplifier, which is used in the noise figure calculations, and is defined as the gain of the amplifier with conjugately matched impedances at both its input and output. The gain measurement derived from the Y-factor method is actually a scalar power gain, which is close to the available gain only if the input and output match of the DUT are close to 50 ohms. For poorly matched devices, like an unmatched transistor, the true available gain requires measurements of all four of its S-parameters, something that cannot be done without a VNA.

The impacts of these assumptions on Y-factor measurement accuracy are best analyzed using a noise-figure uncertainty calculator that includes all of the effects. Sample results from such a calculator are shown later. In the next section, measurement accuracy will be examined in more detail, for both the Y-factor and cold-source methods.

Noise figure measurement uncertainty contributions

To understand the accuracy of noise figure measurements and the differences between the test methods, one must understand the sources of error in the test system and how they interact with the DUT. There are a variety of contributions to noise figure measurement uncertainty. Some of the sources of error are common to both methods, although the magnitude of the errors can be very different, depending on which technique is used, and what level of error correction is applied. Some sources of error are unique to each measurement method.

Examples of common sources of errors are instrument uncertainty and ENR uncertainty. These two sources are the only sources of error that are usually specified. ENR uncertainty is supplied by the manufacturer of the noise source, and is determined by the test methodology used to characterize the excess noise values. Instrumentation errors are generally the smallest sources of error. It would be a mistake to think that overall measurement accuracy can be determined only from these two specifications.

Jitter is another source of measurement error common to both methods, resulting from measurements of low-level random signals (noise). Jitter is used to quantify the accuracy of the estimate of average noise power of a noisy signal. Jitter can be seen as the amount of noise on the noise-figure trace itself (similar to high-level trace noise on an S-parameter measurement, but usually larger), and it relates to the length of time of the noise measurement and the bandwidth of the test system. This contributor can be decreased to an acceptable value by widening the measurement bandwidth, or by increasing the integration (measurement) time, which is accomplished in the PNA-X by increasing the value of noise averaging. Noise averaging is only used during the portion of the noise figure measurement when noise power is measured, and it is controlled independently from sweep averaging, which applies to the completed noise figure trace.

The final common source of measurement error results from drift of the test system, primarily caused by temperature variations. Drift is always present in test systems, but it can be overcome by re-calibration of the test system.

As was mentioned earlier, noise figure measurements are expected to be done with perfect 50-ohm test systems. When the source match of the test system is not exactly 50 ohms, two sources of measurement error occur. If these errors are not corrected, they are often the largest contributions to noise figure measurement uncertainty.

Mismatch errors

The first error due to imperfect system source match results from its interaction with the input match of the DUT, causing mismatch versus frequency of the noise signal. This is the same mismatch effect that occurs when using sinusoidal signals for S-parameter measurements. Figure 5 shows this effect for a Y-factor measurement. The input match of most high-frequency LNAs is nominally 50 ohms, but the actual input match versus frequency varies around this value. The same is true for the source match of the noise source and any electrical network between the noise source and the DUT. Depending on the input match of the DUT, some of the noise power from the noise source is reflected off the amplifier's input. If the noise source supplied a perfect 50-ohm match, this reflected power would be fully absorbed, and the true 50-ohm noise figure of the LNA would be measured. However, if the noise source does not provide a perfect source match, then some of the noise power is re-reflected towards the DUT, where it will constructively or destructively interfere with the original signal, depending on the relative phases of the matches. The effect of this mismatch shows up as the classic ripple pattern seen in the test results if the frequency span is wide enough to show one or more cycles. Often the ripple is not seen because the frequency span of the measurement is too narrow, or the number of measurement points is too small, but the error is still present in the measurement.

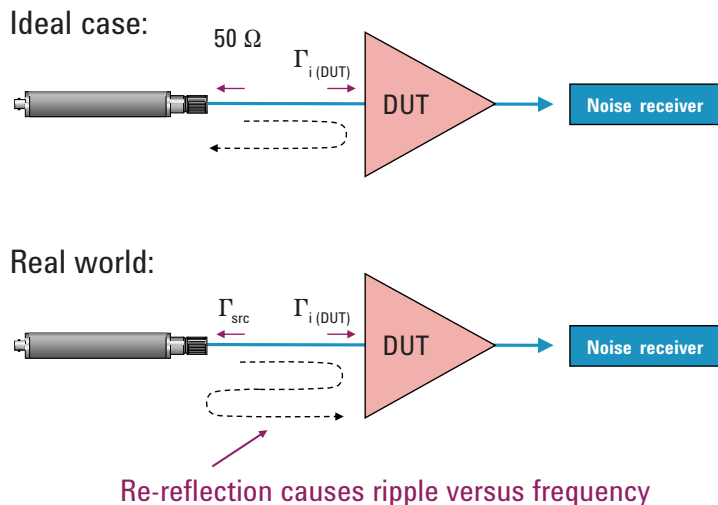

Figure 5. Mismatch errors with Y-Factor method

For the Y-factor method, mismatch errors can be quite large, due to the imperfect match of the noise source (or the noise source cascaded with adapters, cables, switches, or probes), and the inability of spectrum- and noise-figure analyzers to remove the error mathematically. For the cold-source method, the size of the error depends on the quality of the 50-ohm termination at the input of the DUT, and the type of error correction used, if any. When implemented on a VNA with the appropriate error correction, the impact of mismatch error with the cold-source method is very small, since the VNA can measure the S-parameters of the test system and the DUT, and mathematically compensate for the mismatch effect.

Noise parameter effects

The other type of error that results from imperfect system source match is not well known by many test engineers. It is due to the fact that some of the noise generated by the DUT comes out of its input port, where it reflects off the system source match, and reenters the DUT. The reflected noise causes the noise figure of the DUT to change, depending on the phase of the reflected noise power and the correlation among the various noise generators within the amplifier. Thus, the measured noise figure varies as a function of the system source impedance.

This effect is well understood by LNA designers, who measure the noise parameters of the individual devices used to construct the amplifier. The noise parameters tell the designer what the minimum noise figure will be for a given device, and at what source impedance (γ optimum) this minimum will occur. The noise parameters also tell the designer how the noise figure of the amplifier will change as the source impedance moves away from the optimum value. For a given impedance change, the magnitude of the resulting change in noise figure varies between amplifiers or converters. Some devices are very sensitive to changes in source impedance, and others less so. Armed with the knowledge of the device's noise- and S-parameters, the LNA designer can go about designing matching circuitry to optimize gain and noise figure for a particular application.

When measuring noise figure, noise-parameter effects can be a very large source of error if nothing is done to compensate for them. This topic will be explored in more detail in the next section.

Understanding noise parameters

Noise-parameter effects occur at both the input of the DUT and the input of the noise receiver within the test instrument. To understand why noise-parameter errors exist, one must first understand what noise parameters are. The noise parameters of an amplifier describe how its noise figure changes as a function of source impedance, Γ_s . Noise parameters are usually plotted as constant noise figure circles on a Smith chart (Figure 6). A given set of circles is valid at one frequency. For any particular amplifier, whether it is by itself or embedded in the front end of a frequency converter, there is a minimum noise figure that occurs at some optimum impedance, called gamma-opt (Γ_{opt}). The further away the source impedance is from this optimum impedance, the larger the noise figure of the amplifier. The noise parameters of amplifiers are a function of both the bias currents in the transistors and the frequency of operation.

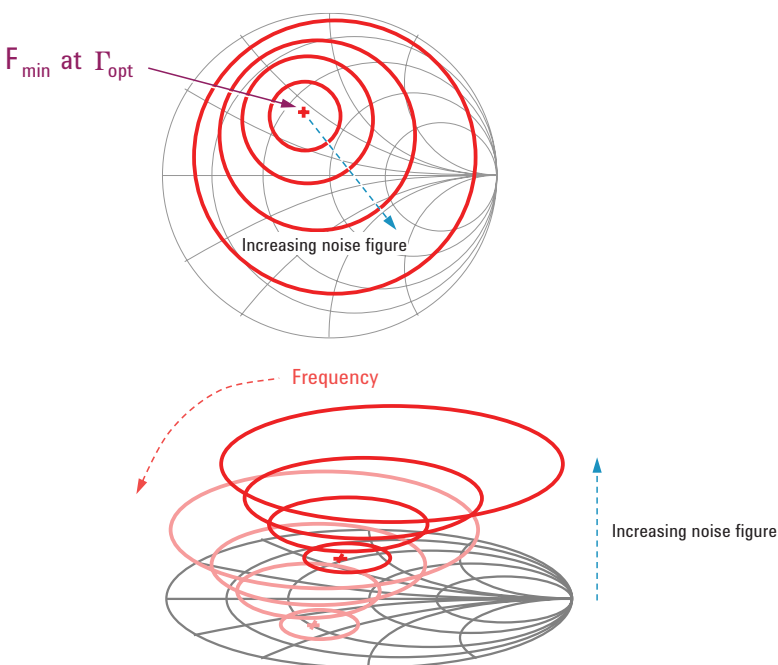

Figure 6. Noise parameters plotted as constant noise figure circles

The effect of noise figure and source impedance can be expressed mathematically in the noise-parameter equation:

$$F = F_{min} + \frac{4R_n}{Z_0} \frac{|\Gamma_{opt} - \Gamma_s|^2}{|1 + \Gamma_{opt}|^2 (1 - |\Gamma_s|^2)}$$

With this equation, one can see that the noise factor F varies as a function of source impedance, Γ_s . Besides Z_0 (50-ohm system reference impedance), there are three constants in the equation (two scalar and one vector) corresponding to the four noise parameters. The four noise parameters are F_{min} (the minimum noise factor), $\Gamma_{opt-magnitude}$, $\Gamma_{opt-phase}$ (the optimum source impedance corresponding to F_{min}), and R_n (noise resistance), which is a sensitivity term that controls how fast noise figure degrades as the source impedance moves away from Γ_{opt} . The terms in the equation that contain the square of absolute values involving Γ_s are what generate constant-noise circles.

Noise correlation

To understand why the noise figure of a device changes versus input match, one must take a closer look at the noisy two-port model of an amplifier. A noisy two-port network will have two noise sources, one associated with the input port, and one associated with the output port. Mathematically, the noise generators can be expressed as current or voltage sources, or a mix of both. The bottom representation shown in Figure 7 is popular for noise analysis, because it separates the noise generators from a perfect gain block, and places the noise generators at the input of the amplifier, making it easier to understand how source match interacts with the two generators. The two noise sources are generally independent from one another, but typically there is some amount of correlation between them, depending on the physical and the electrical characteristics of the amplifier.

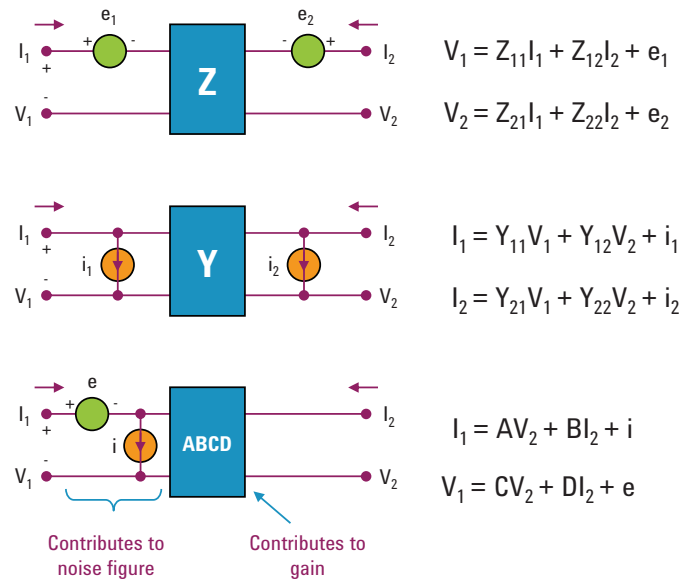

Figure 7. Two-port noise models

The idea of correlation between noise sources is crucial to understanding noise parameters. As shown in Figure 8, if two noise sources are fully correlated, then their instantaneous waveforms (current or voltage) will only differ by a scaling (gain) factor. If they are completely uncorrelated, then each waveform will be truly random and unrelated to the other waveform. For real-world amplifiers, the amount of correlation will be somewhere in between these two extremes, since the noise generators associated with the input and output ports share common active circuitry within the amplifier. These physical noise generators send noise in both the forward and reverse directions (which tends towards correlation), but the magnitude and phase changes in each direction will be different (which tends away from correlation). For example, transistors have gain in one direction, but loss in the other. If there is any correlation between the noise sources, then there will be some value of source impedance (Γ_{opt}) that provides the right amount of magnitude and phase shift to cause maximum cancellation, which results in a minimum noise figure.

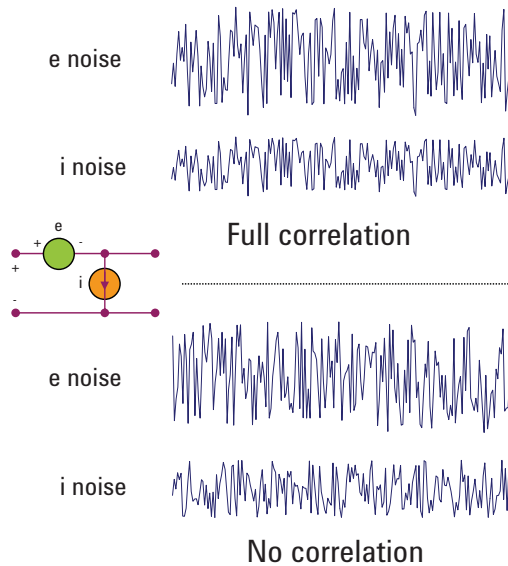

Figure 8. Noise correlation

The concept of noise parameters has a direct implication on our ability to accurately measure 50-ohm noise figure. As the source impedance of the test system varies around 50 ohms, the measured noise figure of the DUT will also vary, as Γ_s crosses the noise circles near the center of the Smith chart. Figure 9 shows the input match of a 15 dB ENR noise source in the off state. While it is centered at 50 ohms, its reflection coefficient clearly changes as a function of frequency. The uncorrected source match of a VNA is even worse, which is not surprising given its more complex block diagram. Since the noise figure of an amplifier is a function of source impedance, one can see how conventional noise figure measurement systems can introduce significant measurement errors due to non-ideal source match. The impact of this effect again shows up as ripple in the measured results, indistinguishable from the ripple caused by mismatch errors. The more the source match changes, the larger the error introduced into the noise figure measurement.

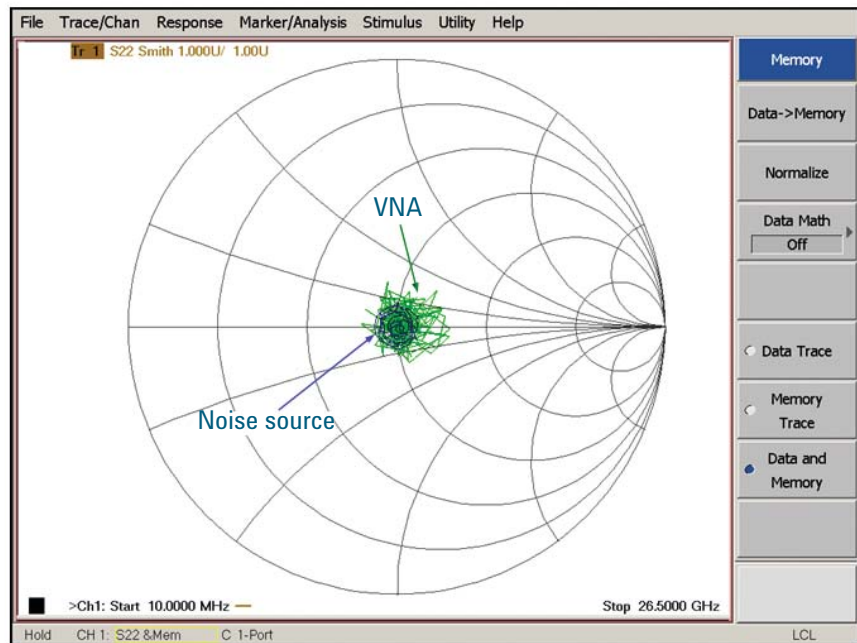

Figure 9. Source match of noise source and VNA

Noise-parameter effects are present for both the Y-factor and cold-source methods. For Y-factor measurements, noise-parameter-induced errors are present even when the noise source is connected directly to the DUT. When the match of the noise source is good, this is usually a small error. However, depending on which noise source is used and at what frequency, this error can be significant. Adding components between the noise source and the DUT exacerbates the effect, even if loss compensation is used, resulting in much larger errors.

When using a VNA with the cold-source method, the raw system source match is generally poor if no attenuators or source-correction techniques are used. Using the PNA-X's unique vector source-correction method, which will be discussed later, the effective source match is excellent, resulting in very little uncertainty due to the noise parameters of the DUT or the noise receiver within the PNA-X.

Noise figure error models

Now that the major sources of error in noise figure measurements have been examined, we can look at visual error models that show how the test system and DUT interact during calibration and measurements. Figure 10 is a simplified model of the uncertainty present in Y-factor measurements. The ENR uncertainty is present in both the calibration step and during the measurement. Mismatch errors are due to the imperfect match (not exactly 50 ohms) of the noise source, noise receiver, and DUT. Noise parameter errors are also due to the imperfect match of the noise source, causing the noise figure of the noise receiver and DUT to change versus frequency. This source of error is dependent on the noise parameters of the receiver and the DUT. Jitter and instrument uncertainty are relatively small sources of error.

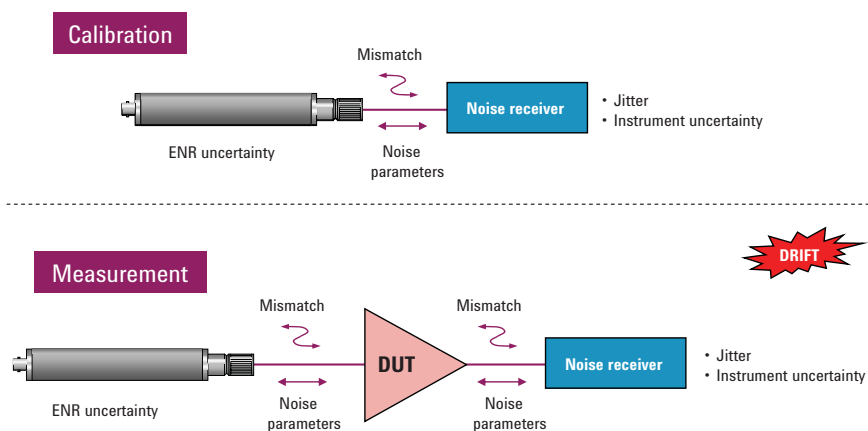

Figure 10. Y-factor uncertainty model

Figure 11 is a simplified uncertainty model for the PNA-X's implementation of the cold-source method, using a noise source to calibrate the PNA-X's low-noise receiver. The calibration process has more steps than that of the Y-factor method. ENR uncertainty is only present in the calibration step since the noise source is not used during the measurement. Notice that the mismatch and noise parameter error terms are shown, but they are very small due to Agilent's advanced error correction methods. S-parameter uncertainty, receiver input match uncertainty, and gamma uncertainty of the impedance tuner are additional sources of error, but these are also small due to vector error correction. Jitter is also present, just as it is in Y-factor measurements, and dynamic accuracy is equivalent to instrument uncertainty. Both of these are small sources of error.

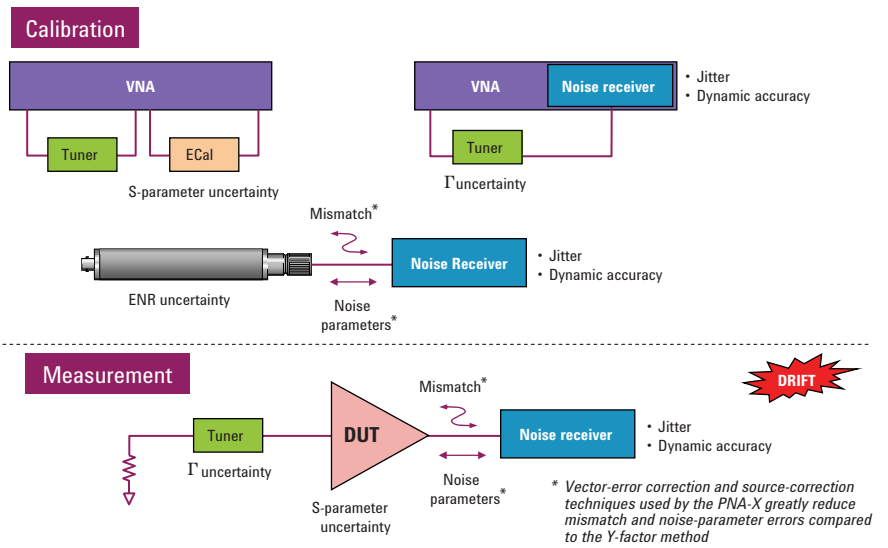

Figure 11. PNA-X's cold-source uncertainty model

To estimate overall measurement uncertainty, a Monte-Carlo uncertainty calculator was developed by Agilent which combines all of the sources of error for each noise figure method. In this way, one can compare the overall accuracy between the Y-factor and cold-source methods for a particular DUT. An example of this will be shown later. The PNA-X uncertainty calculator (Figure 12) can be downloaded from www.agilent.com/find/nfu.

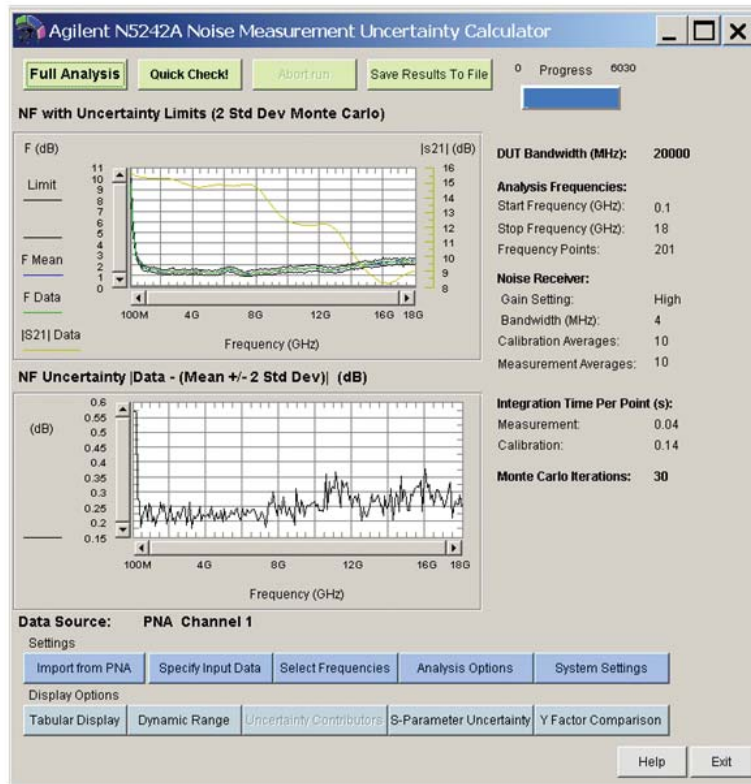

Figure 12. The PNA-X noise figure uncertainty calculator uses the Monte-Carlo method to calculate overall noise figure measurement uncertainty.

PNA-X's Unique Approach

In this section, the PNA-X's unique implementation of the cold-source noise figure measurement technique will be examined, showing how measurements can be made on amplifiers and frequency converters, and on balanced (differential) devices.

The noise-figure options for the PNA-X extend the range of measurements that can be made with a single connection to the DUT. For example, with a single connection, one can measure S-parameters, noise figure, gain and phase compression, harmonics, and intermodulation distortion (IMD). The PNA-X's noise figure measurements provide the highest accuracy of any noise figure solution on the market today.

Option choices

Several options are available to add noise figure measurement capability to the PNA-X. Option 029 (for N5241A 13.5 GHz and N5242A 26.5 GHz models) and Option H29 (for N5244A 43.5 GHz and N5245A 50 GHz models) add both hardware in the form of 13.5 GHz (for N5241A) or 26.5 GHz (for N5242/44/45A) low-noise receivers, as well as specialized calibration and measurement algorithms. Option 028 applies the calibration and measurement algorithms to the standard receivers (the ones normally used for S-parameter, conversion gain, compression, and IMD measurements), extending noise figure measurement capability to 50 GHz.

Figure 13 shows the block diagram of a two-port N5241A (13.5 GHz) or N5242A (26.5 GHz) PNA-X with the additional noise figure hardware included with Option 029. When measuring noise figure with the low-noise receiver, five noise bandwidth settings are available: 24, 8, 4, 2, and 0.8 MHz. With the extra bridge at test port two, the S-parameter, conversion gain, and noise-power measurements needed for the cold-source method can be done without mechanical switching. This is particularly useful when multiple measurements are needed to tune a device for optimum noise figure, or if the unit is part of a high-volume manufacturing-test system.

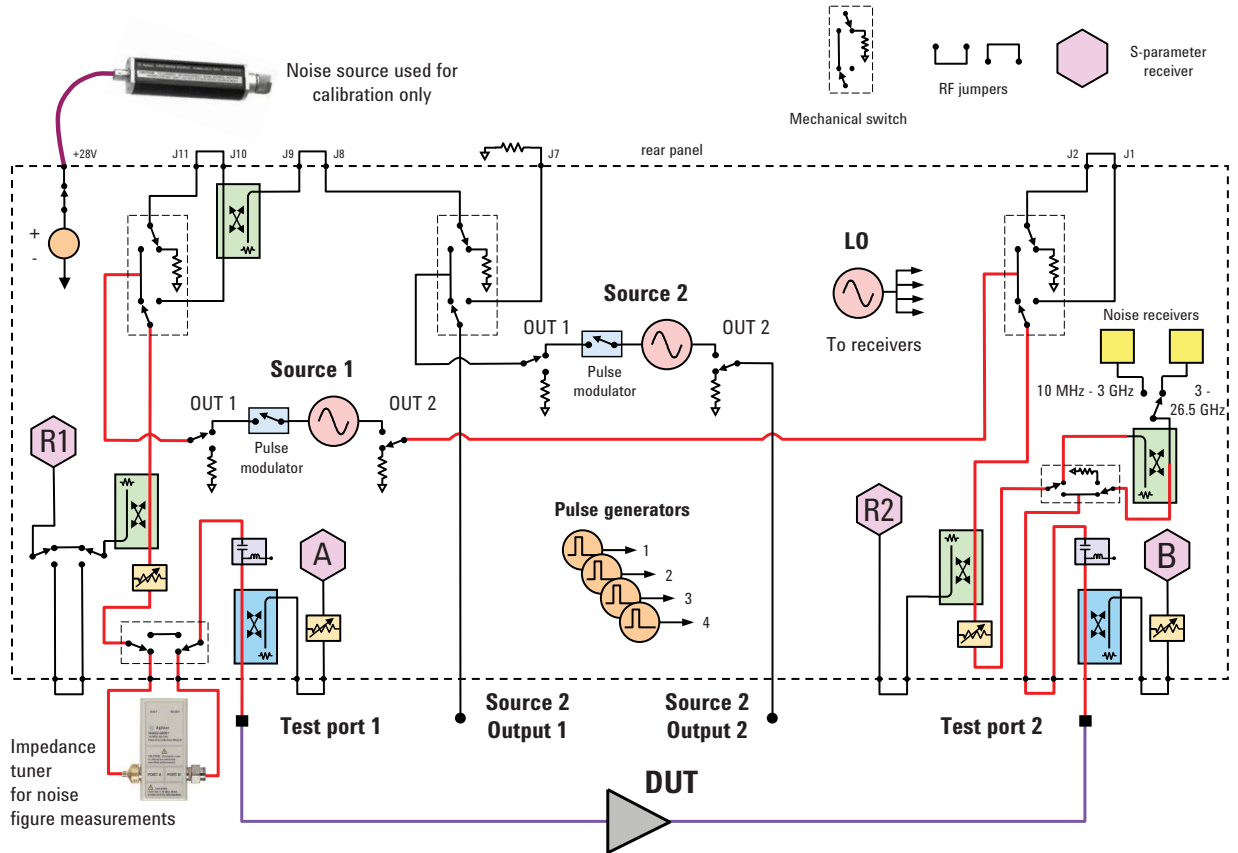

Figure 13. Two-port PNA-X with noise figure hardware option

The PNA-X noise figure solution also requires a noise source (when using the low-noise receivers) and/or a power meter (when using a standard receiver or when measuring frequency converters), both of which are only used during calibration. For fully vector-source-corrected measurements, a standard ECal module is required that must be dedicated as an impedance tuner. In addition, another ECal module or mechanical calibration kit is required for the S-parameter portion of the calibration.

The ECal module used for the impedance tuner helps remove the effects of imperfect system source match, which will be explained in more detail below. This gives high accuracy at the same time as single connection measurements. A bypass switch on the source loop of test port one is included with Options 029 and H29 so that the tuner ECal module can be bypassed during compression or IMD measurements if needed. A scalar calibration choice is also available that offers less accuracy, but is faster and does not require the ECal module used as an impedance tuner. Even with full vector-source correction, the PNA-X noise figure solution is fast compared to NFA and spectrum analyzer-based solutions (Figure 14). Since the PNA-X is so fast, a greater number of points can be used for high-resolution measurements.

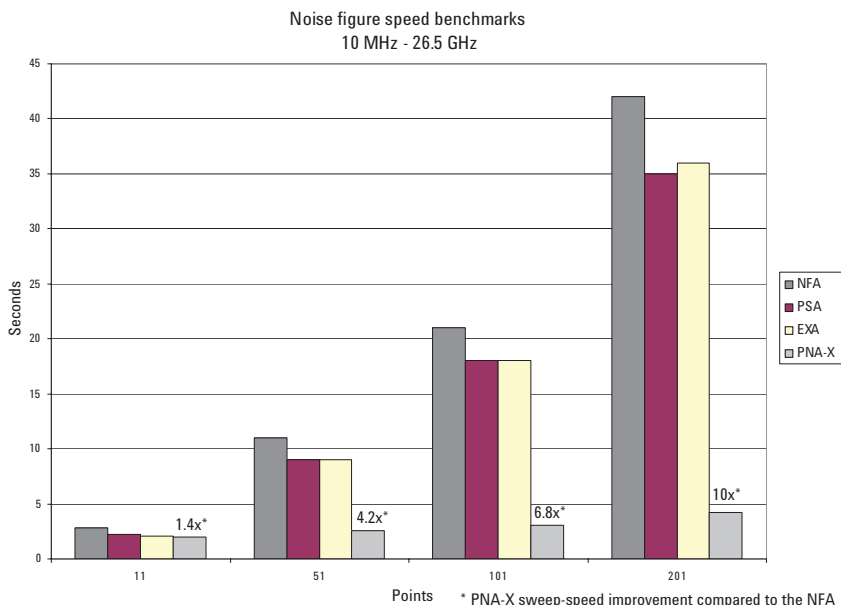

Figure 14. Speed comparison of PNA-X versus Y-factor measurements, without averaging

Correcting for noise-parameter effects

As was previously mentioned, normal vector-error correction is used with VNAs to correct for mismatch errors. To correct for noise-parameter errors, the noise parameters of the DUT must be measured, which in turn requires an impedance tuner at the input of the DUT. The impedance tuner can be the electromechanical type normally used with a noise-parameter test system, which presents a broad range of source impedances to the DUT, or the aforementioned ECal module, which presents a more limited range of impedances needed to calculate 50-ohm noise figure. For more effective second-stage noise corrections, the noise parameters of the noise receivers are also measured during the calibration process.

Figure 15 shows this concept graphically. On the Smith chart, the square in the middle indicates the place where we would like to measure the noise figure of our DUT. This corresponds to a perfect 50-ohm source match. However, as discussed previously, we know our test system does not provide a perfect 50-ohm match. Instead of just assuming that we are measuring noise figure with a perfect source match, we instead intentionally provide a set of impedances that are NOT 50 ohms, but whose values are well known. As shown in the figure, we present the DUT with a minimum of four different impedances at each frequency, and at each impedance value we measure the noise power coming from the DUT. The impedances of these four states are measured during the system calibration, and the noise powers are measured with the DUT in place. The impedance/noise-power pairs are then used to solve the noise-parameter equation (using four equations with four unknown variables), which in turn allows a very accurate calculation of 50-ohm noise figure. So, from the measurements shown as small circles on the Smith chart, we can accurately calculate the noise figure associated with the square at the center of the chart.

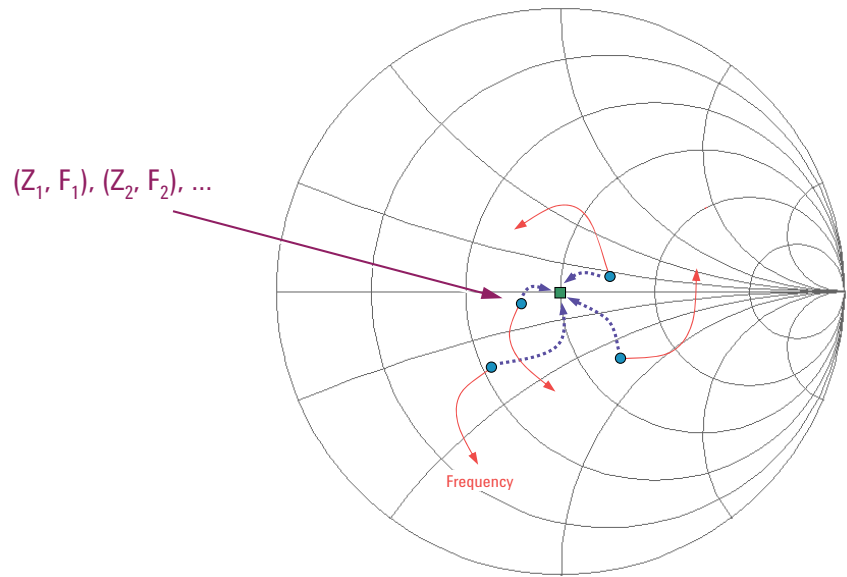

Figure 15. Graphical depiction of the PNA-X's unique source-corrected technique

Just as vector-error correction is used to greatly improve a VNA's raw source and load match for S-parameter measurements, the source-correction method makes the PNA-X's imperfect source match appear to be quite good for noise figure measurements. During the actual measurement of the DUT, a frequency sweep is done for each impedance state, rather than varying the impedance states at each frequency point, resulting in faster overall measurement times. When using the N4690 series of ECal modules, the user can choose up to seven impedance states to improve accuracy by using over-determined data.

Measurement comparisons of PNA-X and Y-factor method

Using the Monte-Carlo-based noise figure uncertainty calculator previously described, Figure 16 shows the calculated measurement uncertainty of an example LNA measurement done in an automated test environment, comparing the PNA-X's source-corrected technique with the Y-factor technique using a 14 dB ENR noise source. For this example, the specifications of the LNA were as follows: Gain = 15 dB, input/output match = 10 dB, noise figure = 3 dB, $F_{\min} = 2.7$ dB, $\Gamma_{\text{opt}} = 0.27 + j0$, $R_n = 12$ to 33.

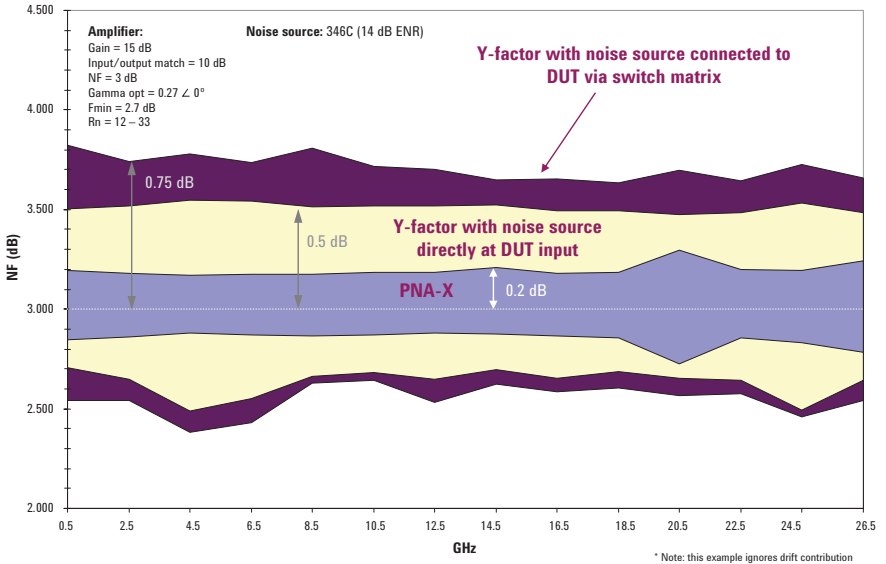

Figure 16. Noise figure uncertainty example of ATE environment

In this case, even when the noise source is connected directly to the amplifier, the PNA-X achieves significantly lower measurement uncertainty than the Y-factor method (0.2 dB for the PNA-X versus about 0.5 dB for Y-factor). With the addition of a simulated switch matrix between the noise source and the LNA, the Y-factor measurement uncertainty degrades to around 0.75 dB. For low and medium noise figure devices, the amount of improvement provided by the PNA-X is quite significant.

Figure 17 shows a breakdown of the major contributors to measurement uncertainty of the previous example. With the Y-factor method, the two largest sources of error are caused by imperfect system source match. The largest error is the noise-parameter effect caused by the non-ideal match of the noise source interacting with noise generated by the DUT. The second largest source of error is due to mismatch effects. Notice that when a simulated ATE network is inserted between the noise source and DUT, the noise-parameter contribution gets even larger compared to the mismatch contribution. For the PNA-X's source-correction method, the largest source of error is the ENR uncertainty of the noise source used during calibration, which affects the accuracy of the measurement of the PNA-X's internal noise receivers.

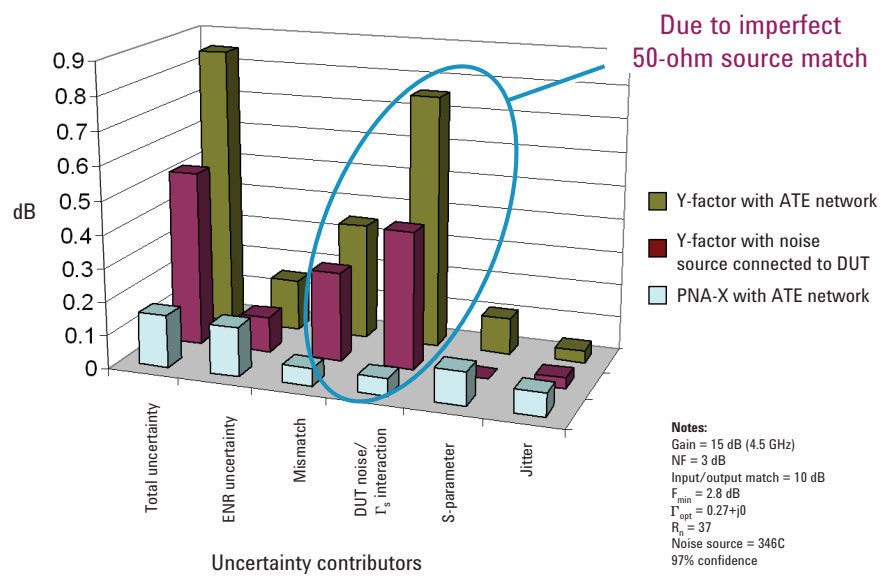

Figure 17. Breakdown of error contributions for noise figure uncertainty example of ATE environment

Figure 18 shows an on-wafer measurement example, where the LNA under test is not packaged. This means that when using the Y-factor method, the noise source cannot be connected directly to the amplifier, but instead must be connected via a cable and a wafer probe. The PNA-X's uncertainty has increased somewhat due to the loss of the wafer probes, which is most significant above 24 GHz. However, the PNA-X's uncertainty is still much lower than that of the Y-factor method. Adding a switch matrix to an on-wafer setup makes the Y-factor method even worse than the previous example. Now there is about 1.1 dB of uncertainty compared to 0.3 dB for the PNA-X.

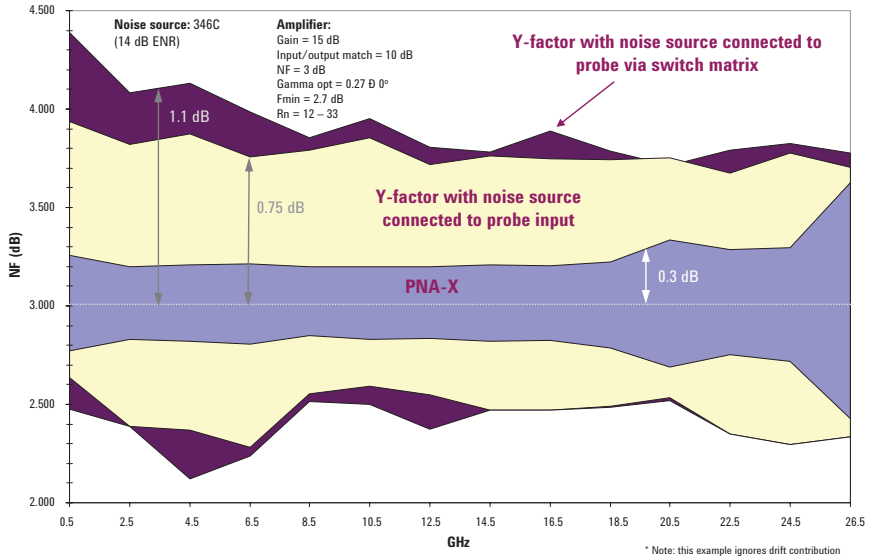

Figure 18. Noise figure uncertainty example of on-wafer setup

Figure 19 shows the uncertainty breakdown of the on-wafer example. Again, as with the ATE example, the major sources of error for the Y-factor method are due to mismatch and noise-parameter-effects.

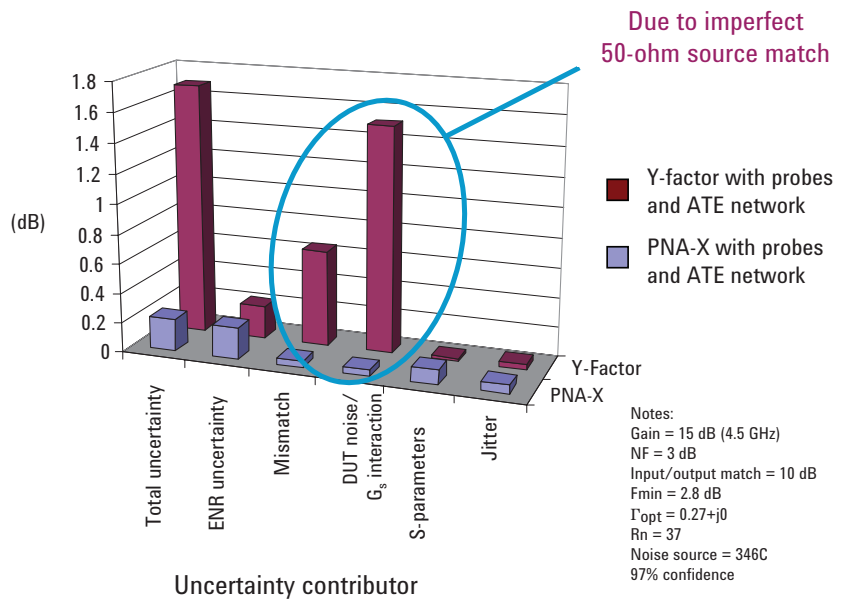

Figure 19. Breakdown of error contributions for noise figure uncertainty example of on-wafer setup

Figure 20 shows an actual 401-point broadband measurement of a packaged, unmatched, low-noise transistor, comparing the PNA-X's source-corrected method with the Y-factor method using a high ENR (14 dB) noise source. Achieving good measurement accuracy for this device is difficult due to its poor input match. Notice that the PNA-X trace is relatively smooth and nicely centered within the ripple of the Y-factor method. The ripple in the Y-factor measurement is rarely seen due to two reasons. The first reason is that many devices are narrowband, so the measurement span is often too narrow to show the inherent ripple. For a narrowband application at a center frequency below about 15 GHz, the Y-factor method can either make the LNA look a lot better or a lot worse than its true performance. The second reason is that even for broadband measurements, the slow speed of the Y-factor measurement usually means that a small number of measurement points are used. This gives an under-sampled or aliased representation of the device's actual performance. In the figure, the data is shown as it would appear if only 11 measured points were used, which is the default value for the number of trace points for the NFA. With 401 points, the ripple clearly shows. The PNA-X, with its lower ripple and therefore higher measurement accuracy, gives a truer picture of the noise figure of the device.

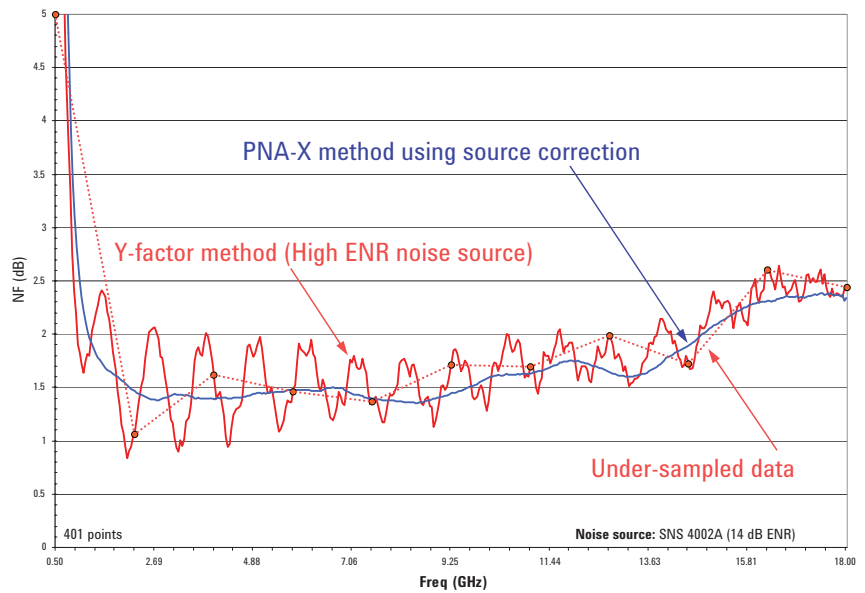

Figure 20. Example noise figure measurements of PNA-X and NFA, using high ENR noise source

Figure 21 shows the same measurement using a low-ENR (6 dB) noise source. In this example, the ripple in the Y-factor measurement has been reduced, but it is still worse than that provided by the PNA-X.

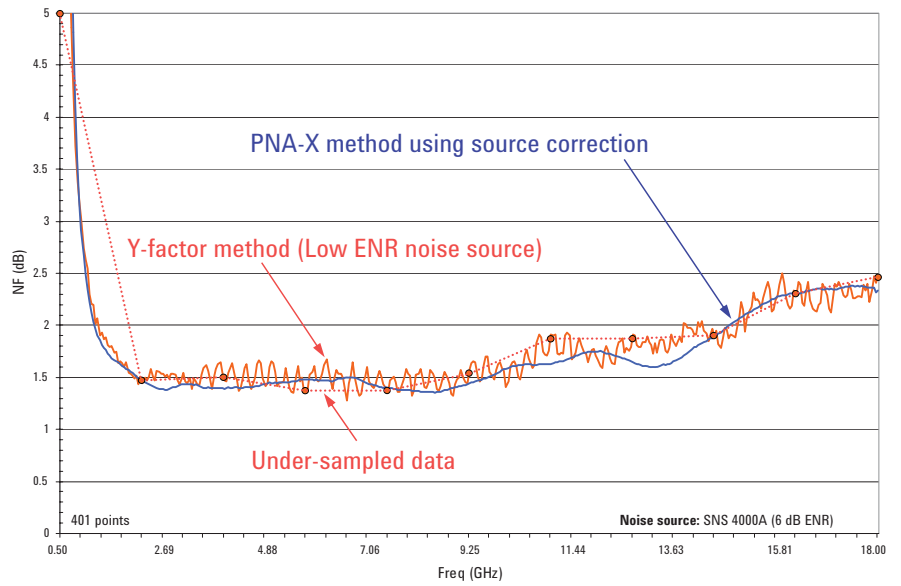

Figure 21. Example noise figure measurements of PNA-X and NFA, using low ENR noise source

Another way to show if source-match-induced measurement errors are present in a test system is to use an airline to rotate the phase of the source match presented to the DUT. Figure 22 shows the noise figure of an amplifier by itself and with an airline in front of it. If the test system removes the effect of imperfect source match, the addition of an airline should only increase the noise figure by the loss of the airline, which at these frequencies is well under 0.1 dB. This effect can be seen in the lower plot made with a PNA-X. However, in the upper plot, made with an NFA and a 14 dB ENR noise source, one can see that adding the airline can cause large differences in noise figure (depending on the frequency), more than what is theoretically correct. The large changes show that the Y-factor measurement is being adversely affected by the system source match. As was discussed previously, the mismatch and noise-parameter effects due to imperfect system source match cannot be removed with the Y-factor method.

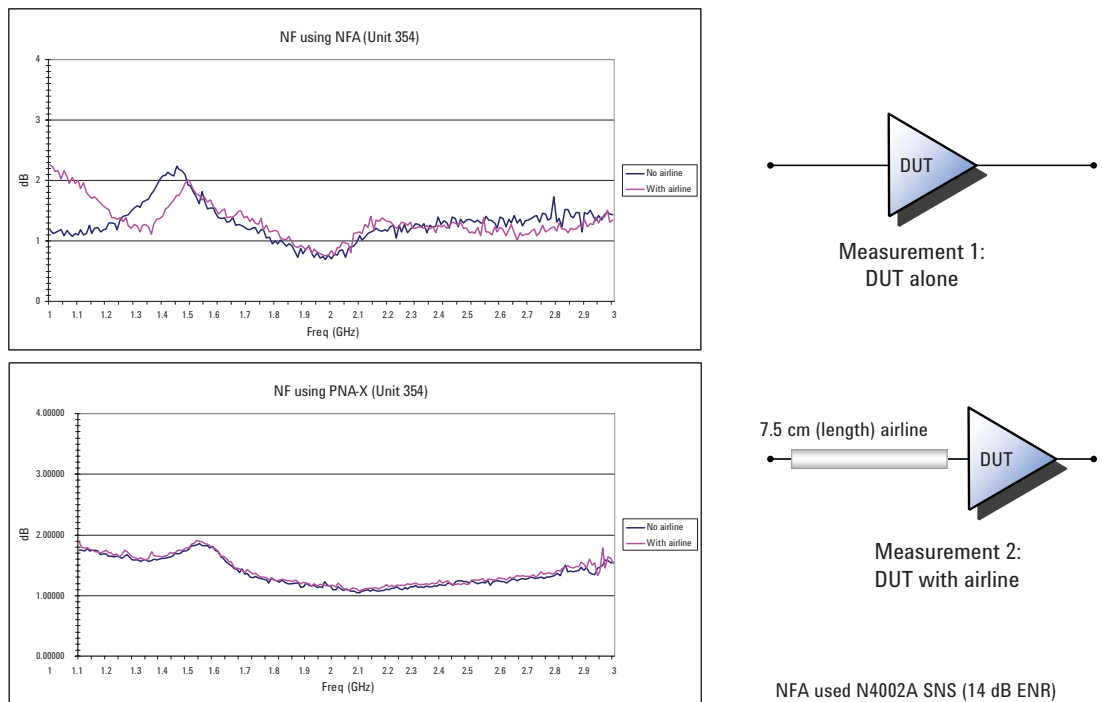

Figure 22. An airline is an effective tool to show source-match-induced measurement errors

Figure 23 shows another example of how imperfect system source match can cause ripple in noise figure measurements using the Y-factor method. In this case, a simple 12-inch section of flexible cable was placed in front of the DUT, to simulate an ATE environment. For the Y-factor measurements, the cable was inserted between the noise source (14 dB ENR) and the DUT. The scalar loss of the cable was removed using the loss-compensation table within the NFA. High ENR noise sources are often used in ATE systems since the loss between the noise source and the DUT is too large to get good results using a low-ENR noise source. With the PNA-X measurements, the cable was part of the test system, and the calibration planes were at the input and output of the DUT. The large ripple in the Y-factor measurements again show that imperfect system source match causes large sources of error.

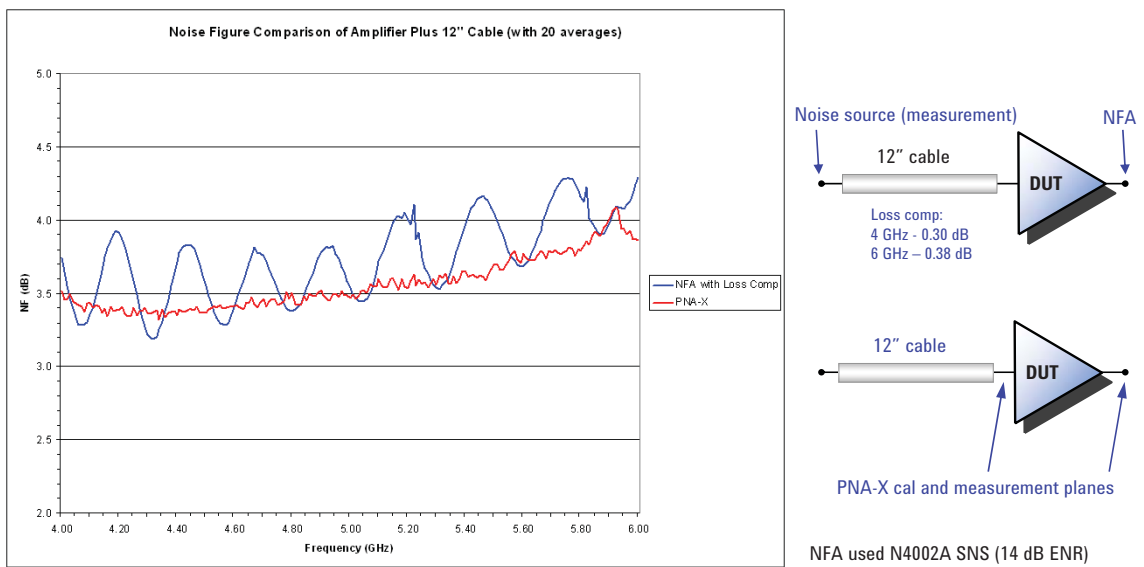

Figure 23. Noise figure measurement in pseudo-ATE environment

Scalar noise calibration

So far, this application note has described how the PNA-X corrects for imperfect source match by presenting four or more impedances to the DUT during the noise figure measurement. This method is invoked by selecting the “Vector Noise” choice during calibration. Another calibration choice exists called “Scalar Noise” that is simpler and faster, but less accurate. This variation still uses the cold source method where the DUT’s gain and output noise power is measured. However, scalar noise calibration assumes the system source match is exactly 50 ohms versus frequency, and therefore eliminates the need for an impedance tuner. There are two advantages to this approach: the measurement is faster, since only one noise-power sweep is needed instead of the four to seven noise-power sweeps required for vector noise calibration, and it is less expensive as the cost of the ECal module used as the impedance tuner is removed from the system price. The trade off is that there is more ripple (and therefore less accuracy) in the measurement, as the error due to the noise parameters of the DUT cannot be removed. The size of the error depends on how good the system source match is, and the sensitivity of the DUT to source-impedance variations.

Figure 24 shows a comparison between vector and scalar noise calibration. As can be seen, the vector method gives the smoothest trace, and adding external attenuators at the end of the test port cable helps reduce ripple when using the scalar noise calibration. For this DUT, using a 6 dB attenuator gives results close to those obtained using vector noise calibration.

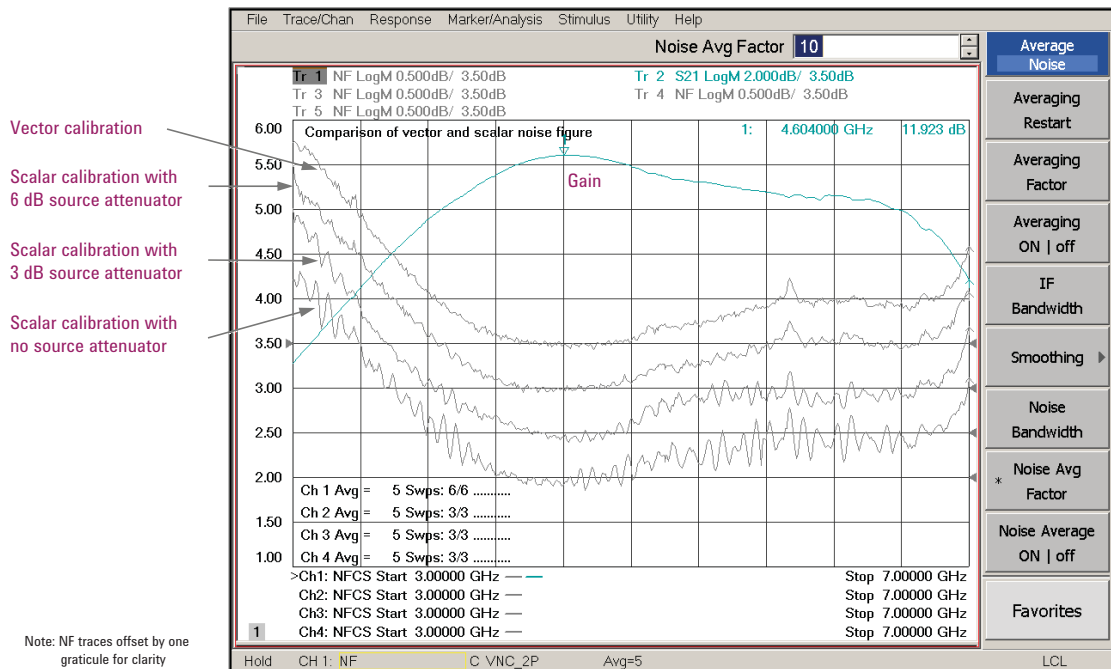

Figure 24. Vector noise versus scalar noise calibration

Sweep considerations

When testing amplifiers, in addition to the four to seven noise power sweeps required for vector noise calibration, two conventional S-parameter sweeps (forward and reverse) are done in order to accurately measure the gain of the amplifier under test. So, with the default value of four impedance sweeps, the analyzer must make six separate sweeps to gather the required data to calculate noise figure. When testing frequency converters, the minimum number of sweeps is eight, as two additional sweeps with the sinusoidal source are needed when measuring match-corrected conversion gain, to take into account the difference in frequency between the input and output signals. When using scalar noise calibration, only three sweeps are needed for amplifiers (two sweeps for S-parameters plus one noise-power sweep), and five for frequency converters (four sweeps for match-corrected conversion gain plus one noise-power sweep). Figure 25 shows measurement speeds between the scalar and vector methods when measuring an amplifier, with and without noise averaging, and with different number of trace points. When noise averaging is used (recommended), the scalar method is about four times faster.

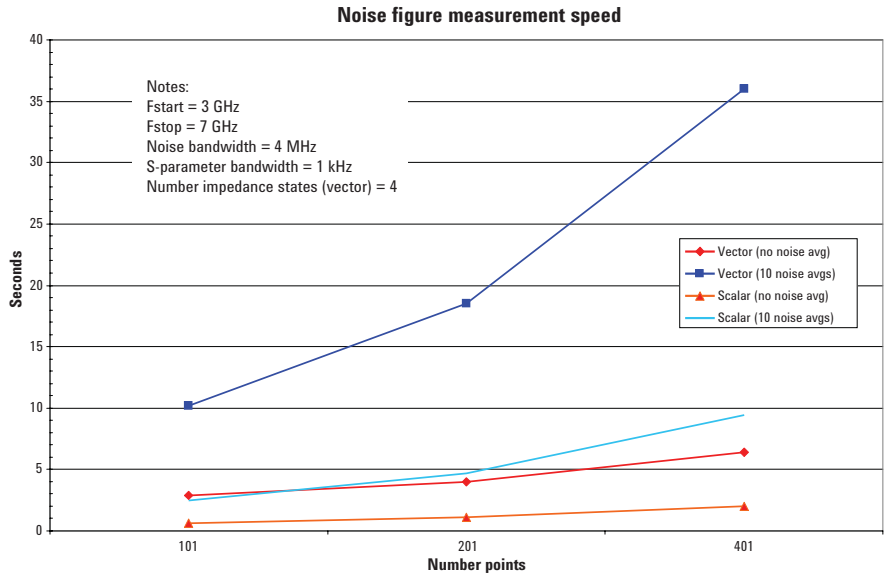

Figure 25. Scalar noise calibration offers about a four times improvement in measurement speed

If low-noise receivers are present in the instrument (included with Options 029 and H29), the noise-power sweeps are done with the low-noise receivers (with the internal sinusoidal source switched off), while the standard receivers are used for the S-parameter or conversion-gain measurements (using the internal sinusoidal source). Because of the extra bridge at test port 2 that comes with the low-noise receivers, once the instrument is switched into noise-figure measurement mode, no additional mechanical switching is needed when switching between the standard and low-noise receivers. With Option 028, all of the measurements are done with the standard receivers.

Using the standard receivers for measuring noise figure

With PNA-X Option 028, the standard PNA-X receivers are used to measure noise power as well as the gain of the DUT, both of which are needed to calculate noise figure (Options 029 and H29, which contain low-noise receivers, also allow the use of the standard receivers for noise figure measurements, as shown in Figure 26). In order to use the standard receivers for measuring noise figure, there are some practical limitations involving gain and filtering that must be understood and overcome in order to make usable measurements. These issues are addressed with the low-noise receivers that are available with Options 029 and H29. Figure 27 shows the block diagram of the high band (3 to 26.5 GHz) section of the low-noise receivers in Option 029 and H29. There are two key blocks that are present: one, the LNA at the input, and two, the filter bank in front of the mixer.

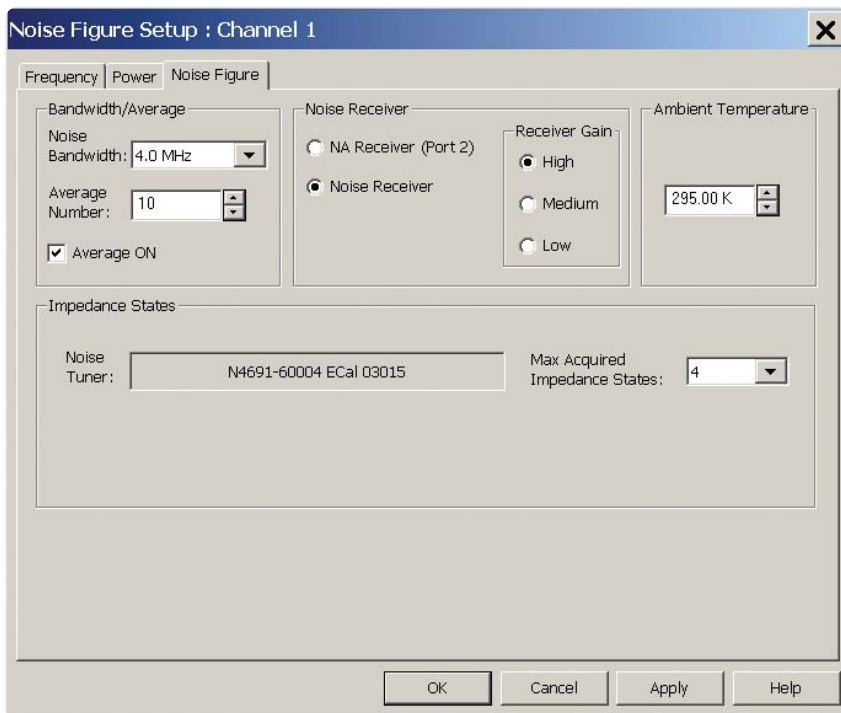

Figure 26. Option 029/H29 noise figure setup dialog, showing choice of noise receiver or standard NA receiver

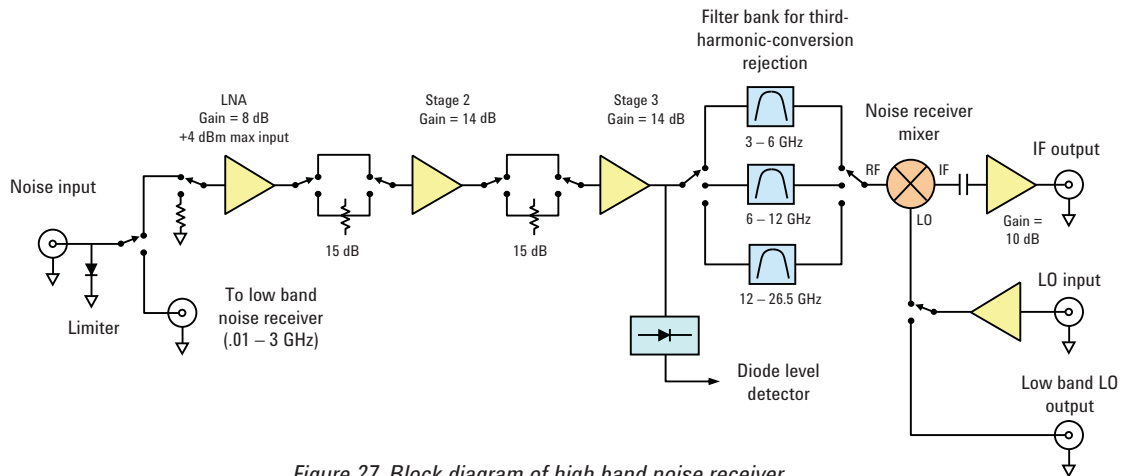

Figure 27. Block diagram of high band noise receiver

Gain requirement

The LNA provides gain without adding much noise (i.e., it has a low noise figure), which means the sensitivity for the overall receiver is good. Figure 28 shows the typical noise figure at test port two with Option 029. The LNA enables measurements on devices with both low noise and low gain, without requiring an external preamplifier. For DUTs with gain-plus-noise-figure up to approximately 30 dB, all three input amplifiers are used. For DUTs with more than 30 dB of excess noise, stages two and three can be switched to a 15 dB loss setting as needed to avoid receiver compression.

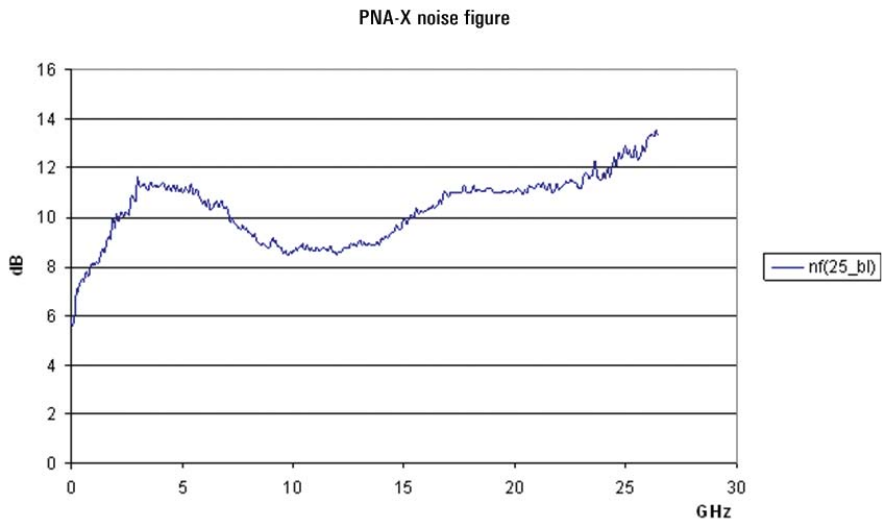

Figure 28. Typical noise figure of port two

When using the standard receivers, which do not have an LNA before the mixer and therefore have a high effective noise figure of 20 to 30 dB (not counting the loss of the test-port coupler), the noise coming into the receiver must be at least as high, and ideally, significantly higher than the internally generated receiver noise. If the DUT has at least 30 dB of gain-plus-noise-figure, this condition will be met. The standard receivers are useful for very high gain devices (> 60 dB), like some frequency converters for example, that would otherwise compress the low-noise receivers even when using the lowest gain setting. For devices with excess noise below 30 dB, an external preamplifier is recommended. The preamplifier can be conveniently placed in the receiver path using the front-panel jumpers, as shown in Figure 29. Since the preamplifier comes after the DUT, its gain is not ratioed out of the measurement. Therefore, it is important to have a stable ambient temperature, and calibration and measurements should only be performed after the preamplifier is fully warmed up. When using an external preamplifier, an external filter is usually required at the output of the preamplifier, as described below.

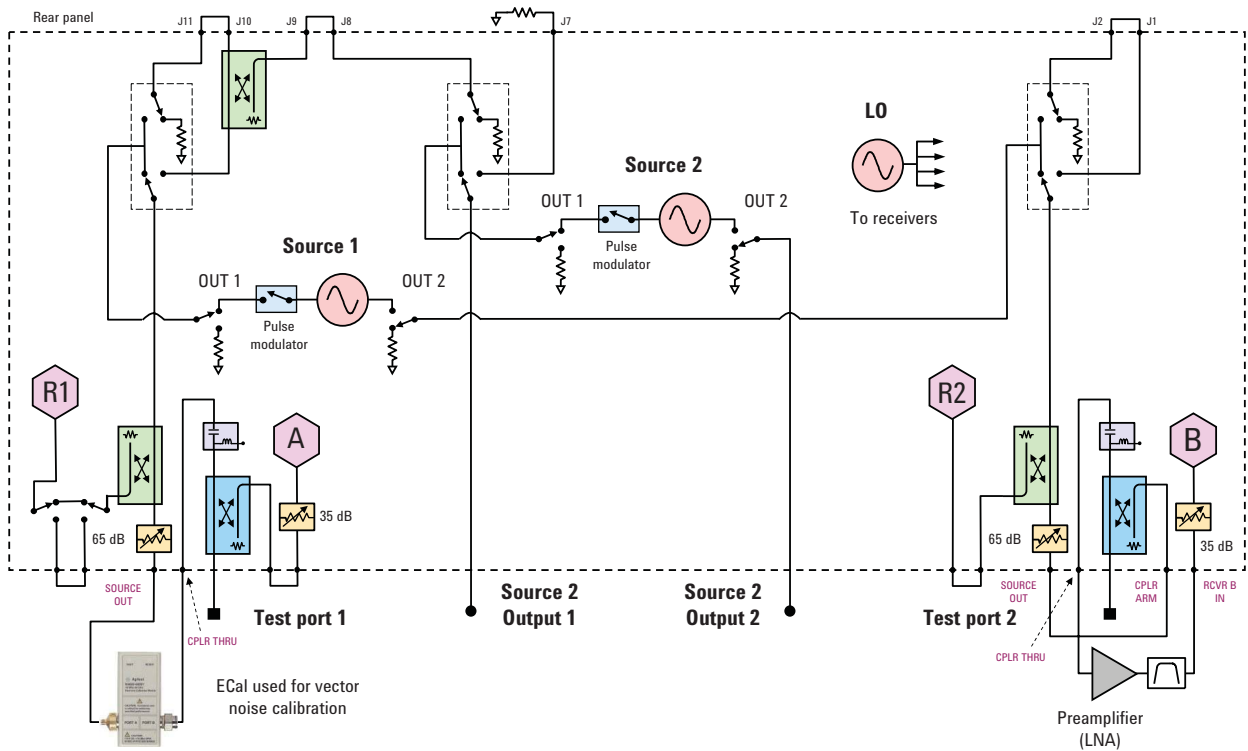

Figure 29. Placement of an external preamplifier and filter for noise figure measurements using a standard receiver, with the port two coupler reversed

Whether or not a preamplifier is used, it is recommended for most devices to reverse the test coupler at the port used to measure noise figure with the standard receiver (shown in Figure 30), as this removes the coupler loss in the receiver path. This improves system sensitivity by about 15 dB above 1 GHz, and more than that below 1 GHz, where the coupled arm exhibits a high pass response (Figure 31). Reversing the test-port coupler does not inhibit S-parameter measurements, but it does decrease the available power when making S_{12} or S_{22} measurements. However, this is usually an acceptable trade-off for improved sensitivity when making noise figure measurements.



Figure 30. Jumper cable arrangement for reversing the test port coupler (main and coupled arms swapped)



Figure 31. Test-port coupler frequency response (coupled arm)

Filtering requirement

The other key element of the dedicated low noise receivers is the filter bank before the mixer. These filters remove noise that is around the fundamental or third harmonic of the receiver's LO, depending on whether fundamental or third-harmonic mixing is used in the particular frequency band of the measurement. As shown in Figure 32, when fundamental mixing is used, the mixer internally generates an unwanted third-harmonic signal due to the nonlinear mixing process (higher order harmonics are also generated, but their effects are generally small enough to ignore). If there is noise entering the mixer around the third harmonic, it will get mixed to the IF along with the noise that mixes with the fundamental of the LO. Since the conversion efficiency around the third harmonic is about 10 dB less than that of the fundamental, the amount of additional noise is relatively small. Without any filtering, this additional noise appears to come from the DUT, resulting in an undesired increase in the measured noise figure. The same problem exists when the analyzer is intentionally using the internally generated third-harmonic for mixing the noise down to the IF. In this case however, the undesired excess noise around the fundamental is considerably larger than the desired noise around the third harmonic, resulting in a much larger error than what occurs with fundamental mixing. This problem is eliminated with the appropriate filters in front of the mixer, such as is the case with Options 029 or H29 (up to 26.5 GHz).

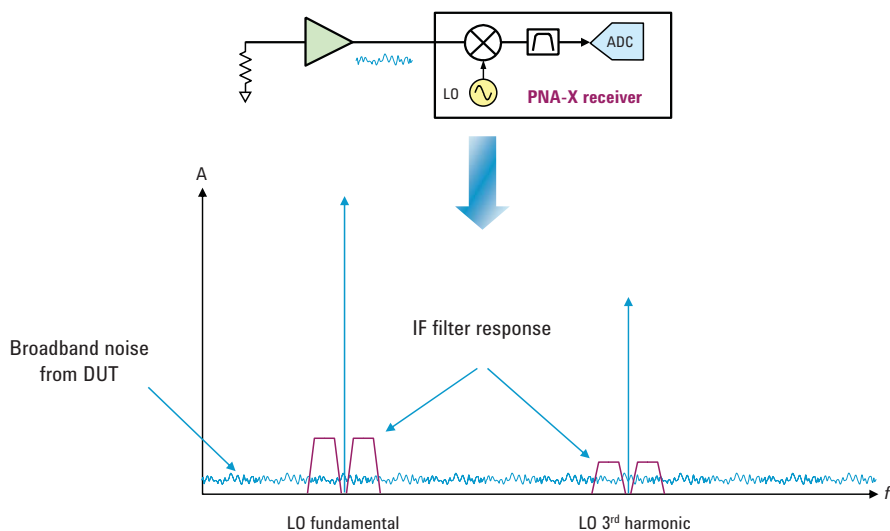

Figure 32. When using a standard receiver, broadband input noise mixes around the fundamental and internally generated third harmonic of the LO

For the 43.5 and 50 GHz PNA-X models, fundamental mixing is used up to 26.5 GHz, and third harmonic mixing is used above 26.5 GHz. Figure 33 compares measurements of an unfiltered broadband amplifier and the same amplifier with a band-pass filter centered at 41 GHz. In the unfiltered case, a huge step in measured noise figure occurs at 26.5 GHz, near the center of the display, and at 41 GHz, the noise figure of the amplifier appears to be about 19 dB. With filtering, the measured noise figure at 41 GHz is at the correct value of 4.5 dB. Devices that are inherently filtered or narrowband in operation don't need external filters when using the standard receivers. When using a preamp in the receiver loop, the preamplifier will need filtering, unless its frequency response is sufficiently narrowband to reject the undesired mixing product. For measurements of broadband devices, more than one filter may be needed to cover the frequency range of interest, in which case the measurement must be broken up into smaller sub-bands. For noise figure measurements covering the entire 10 MHz to 50 GHz range, N5245A Option H29 is recommended. Up to 26.5 GHz, the internal low-noise receivers with their third-harmonic rejection filters can be used, and from 26.5 to 50 GHz, a preamplifier with a single high-pass filter can be used, with a corner frequency somewhere between 18 and 26 GHz. One easy way to implement a coaxial high-pass filter at these frequencies is to connect two coaxial-to-waveguide adapters together, since waveguide transmission lines have an inherent high-pass response.

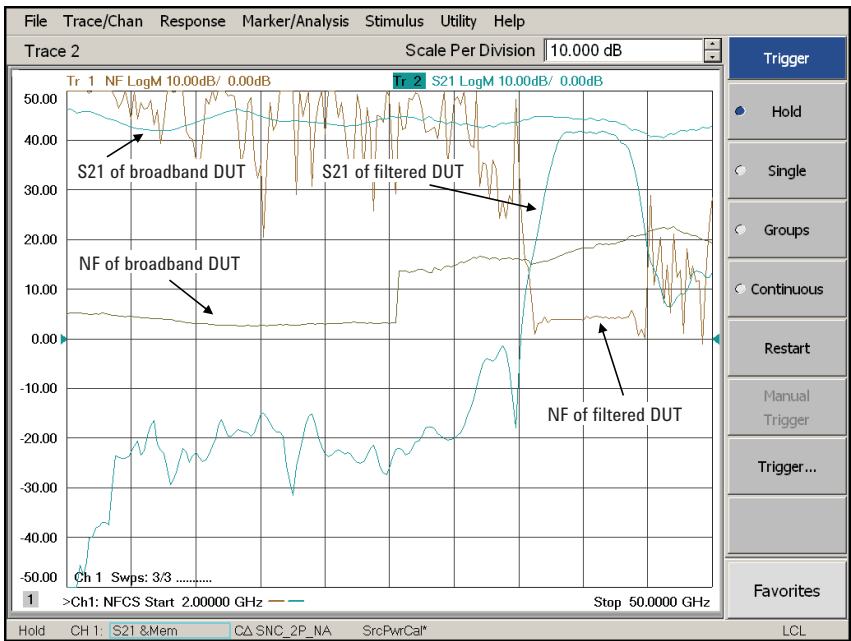

Figure 33. Noise figure comparison of filtered and unfiltered amplifier using 50 GHz PNA-X standard receiver

Noise-power parameters

In addition to measuring noise figure of a device, the PNA-X can also display the noise power coming out of the DUT. The noise power can be expressed in terms of available power (calculated into a conjugately matched load) or incident power (calculated into a 50-ohm load), and can be displayed in absolute terms (dBm, normalized to a 1 Hz bandwidth) or relative terms (dB, relative to -174 dBm). System noise-power parameters include the additional noise power of the noise receivers, whereas for DUT noise-power parameters, the receiver noise contribution is subtracted from the measured noise power. Direct measurements of ENR are also available. For ENR measurements, the PNA-X measures noise power versus frequency with the noise source turned on, and calculates ENR using the measured hot noise values along with the cold-noise values measured during the system calibration.

When noise-power parameters are measured, vector noise calibration is not available. Therefore, the measurements take two sweeps: S_{22} (to correct for the noise-parameters of the receivers when subtracting the receiver-contributed noise for DUT noise-power parameters, and to calculate available power) and a noise-power sweep.

Measuring frequency converters

One advantage of using the cold-source method for frequency converters is it correctly measures both single-sideband (SSB) and double-sideband (DSB) converters. DSB converters have more down-converted noise than the equivalent SSB converter, since there is no image filter in front of the mixer (Figure 34). This means that noise that is present at $(LO + IF)$ and $(LO - IF)$ is converted to the IF. The noise contributions of the two sidebands may not be equal, as they depend on the frequency response of the converter's front-end prior to the mixing stage. If the front-end is flat between the upper and lower IF offset, then the DSB-converter would have 3 dB more noise than the SSB equivalent. If the response is not flat, then the difference can be smaller if the image filter of the equivalent SSB converter is around the larger sideband, and larger differences can occur if the SSB converter image filter is around the smaller of two sidebands. When using the Y-factor method, the measured noise figure would be the same for two equivalent SSB and DSB converters, since a ratio of noise-power measurements is made, and the excess noise of the DSB converter (relative to the SSB converter) is ratioed out. For most DSB DUTs, the NFA or spectrum analyzer-based solution typically reads between 0 and 3 dB better (lower) than the actual noise figure value, although it is possible to see even larger errors. Since the cold-source method measures noise power only once, there is no ratio effect, and therefore the noise figure of DSB and SSB converters will be measured correctly.

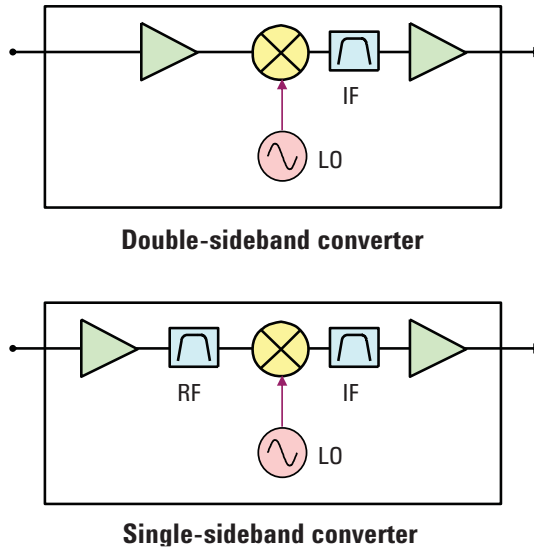

Figure 34. Single-sideband versus double-sideband frequency converters

Measurements on converters with embedded-LOs

Devices with embedded LOs, where there is no access to the LO or its time base, present an additional challenge for converter measurements. Embedded-LOs are common with many satellite transponders, because size and weight limitations and the potential for unwanted spurious signals eliminate easy access to the local oscillators aboard the satellite. Without access to the LO or its time base, a measurement problem can occur because the output frequency of the DUT is not exactly where it should be, since the actual internal LO frequency is never exactly the nominal value. If the offset is large compared to the IF bandwidth used for the conversion gain measurement, then significant gain error would be introduced. The solution is to adjust the tuning of the PNA-X's receivers so the output of the DUT falls in the middle of the IF filter used during the measurement of conversion gain. In order for this approach to be effective, the frequency stability of the internal LOs must be relatively good. This is usually the case for satellite transponders and receivers used in aerospace and defense applications, as their LOs are locked to crystal oscillators that are very stable and have low phase noise.

The tuning process used by the PNA-X is straightforward. First, the RF stimulus is set to the center frequency of the measurement. Next, the PNA-X performs a broadband receiver sweep centered at the nominal output frequency of the DUT (based on the nominal LO frequency). The difference between the peak of the actual signal and the expected signal gives a frequency offset value that can be used to adjust the tuning of the PNA-X's receivers. The frequency span of the internal receiver sweep can be set by the user, and it can be as wide as 10 MHz, although this is much greater than the typical offset of a real converter.

Measuring differential devices

Measuring the noise figure of differential (i.e. balanced) amplifiers is conceptually simple. In order to get a true differential-mode noise signal, it is necessary to use a balun (balanced-to-unbalanced transformer) or a $0^\circ/180^\circ$ hybrid at the input of the DUT. For fully balanced devices, a balun or hybrid is also needed at the output of the DUT, as shown in Figure 35. Hybrids are very useful components because they can be used to measure both differential- and common-mode noise figure, by taking advantage of both the sum or Σ (0°) port, and the difference or Δ (180°) port. When measuring on-wafer devices, test probes are used on the differential (or common) mode side of the balun or hybrid. Making differential (or common) mode measurements can be summarized into three steps:

1. Perform a single-ended noise-figure calibration, without the baluns, or hybrids, or probes, using either a scalar or vector noise calibration
2. Insert the characterized baluns or hybrids (with probes if needed) in between the single-ended test port and the differential ports of the DUT
3. Measure the DUT while deembedding the balun or hybrid at the input (and output if used) using the analyzer's "Fixture" feature

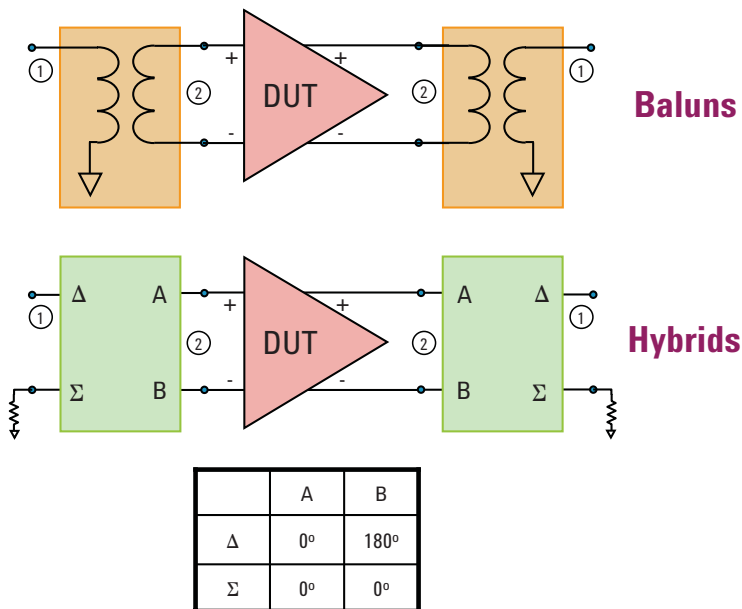

Figure 35. Measuring balanced amplifiers or converters requires baluns or hybrids

Characterizing the baluns or hybrids

Although a balun or hybrid is a three-port device with nine single-ended or mixed-mode parameters, for the purpose of de-embedding, it must be treated as a two-port device with four parameters. This is done by simply ignoring the parameters related to the unwanted mode. For example, for a balun, only the four single-ended-to-differential-mode parameters are important, and the five common- and mixed-mode parameters can be ignored. If measurements of common-mode noise figure using a hybrid are also desired, then in addition to the four single-ended-to-differential-mode parameters, the four single-ended-to-common-mode parameters are also needed.

The differential- or common-mode .s2p files that are used to de-embed the baluns or hybrids must be generated manually prior to the measurement of the DUT. The baluns or hybrids are measured as single-ended three-port devices, and the PNA-X calculates the differential- or common-mode performance from the single-ended data. The first step in this process is to perform a three-port calibration on the PNA-X. Next, add the interconnect cables (and probes if needed) to the baluns or hybrids that will be used during the measurement. Then, set up and measure the desired mixed-mode parameters (Figure 36), using four traces. The single-ended input of the balun or hybrid used on either the input or output of the DUT should be connected to port one of the PNA-X, because when de-embedding is used, the fixture feature expects that port two of the de-embedded component is connected to the input or output of the DUT. When using hybrids, a 50-ohm termination should be placed on the Σ port for differential-mode measurements, and the Δ port for common-mode measurements. If characterization of both modes is needed, the data must be saved in separate data files. Once the appropriate differential- or common-mode data has been measured, the data is saved to an .s2p file [File, Save Data As..., Trace (*.s2p)]. The PNA-X will ask which ports you want to include; so for differential-mode data, choose S1 and D2, and for common-mode data, choose S1 and C2.

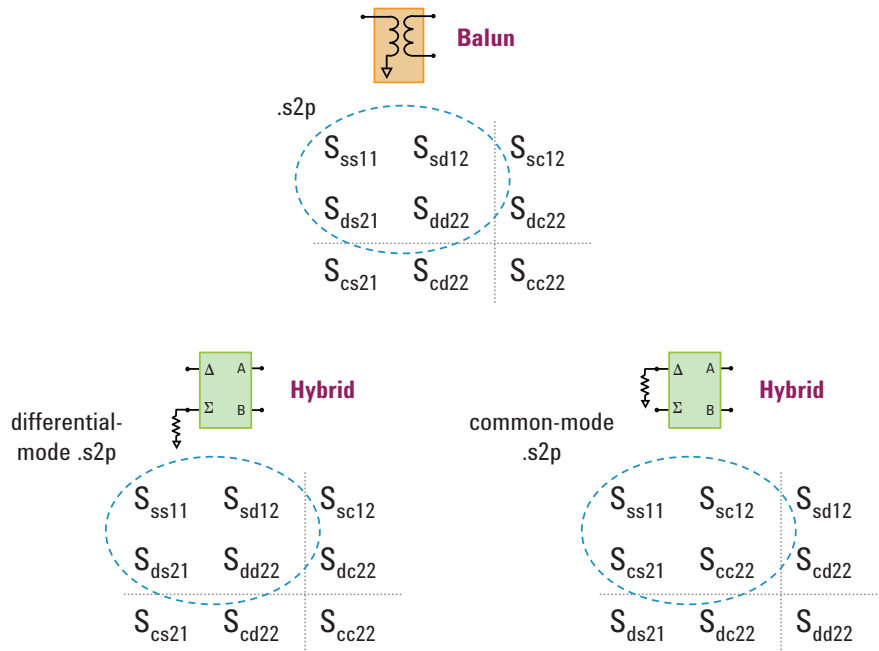

Figure 36. Choose appropriate four differential- or common-mode parameters

Measuring noise parameters

The PNA-X solution described so far is intended for 50-ohm noise figure measurements. Designers of LNAs often need to measure the noise figure versus source impedance of unmatched, highly reflective transistors in order to design optimized matching circuits. This type of characterization yields the noise parameters of the device. For full noise-parameter analysis, a tuner positioned near the input of the DUT is necessary to provide a broad range of source impedances. Maury Microwave has developed a new noise-parameter test system based on the PNA-X that is both faster and more accurate than legacy systems. The setup is much simpler than previous systems based on a separate VNA and noise figure analyzer. The system also uses more advanced measurement algorithms to improve measurement speed by more than 100 times, while providing higher accuracy. Figure 37 shows the improvement in accuracy due to smoother test results using the new method. Maury's PNA-X-based noise parameter test systems are available with frequency coverage up to 50 GHz.

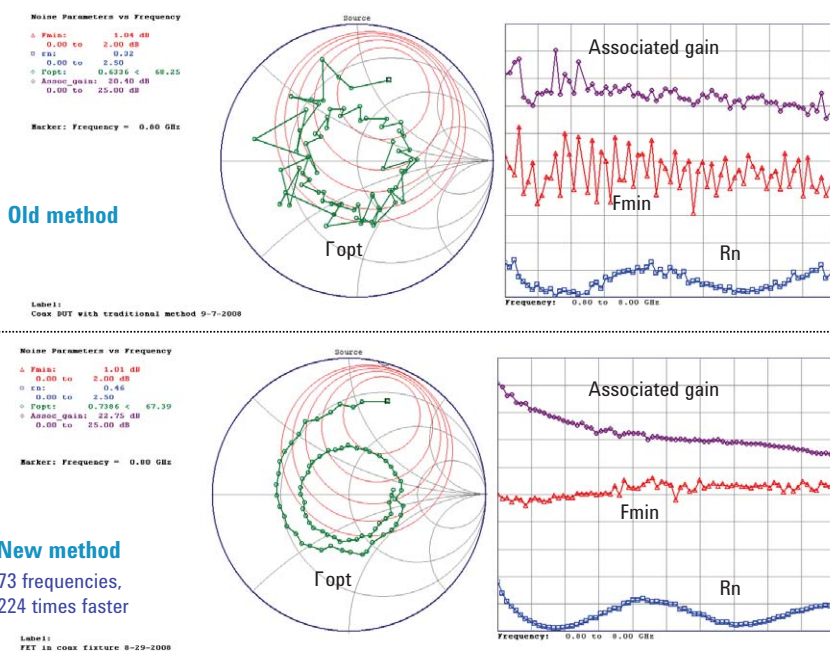

Figure 37. Maury Microwave's PNA-X-based noise parameter system shows improved accuracy and speed compared to legacy systems

Calibration Overview

Performing a noise calibration is relatively simple from a user's point of view. At its simplest, the calibration consists of just three steps when measuring amplifiers, or four steps when measuring converters. The calibration uses the internal sinusoidal source, a noise source and/or power meter, a through connection, and S-parameter calibration standards, provided with either an ECal module or a mechanical calibration kit. During these steps, many more measurements are made compared to a simple S-parameter calibration. Additional steps are needed when mechanical cal kits are used, or adapters need to be de-embedded, as is the case for on-wafer measurements.

Vector noise calibration

Figure 38 shows an overview of the calibration procedure used by the PNA-X for vector-calibrated amplifier noise figure measurements, when two ECal modules are used with the low-noise receivers. The calibration consists of three steps. In the first step, the noise source is connected to port two of the test system. Hot and cold noise power measurements are made, along with the corresponding matches of the noise source. The second step consists of connecting a through between test ports one and two. In this step, the gain differences between the three noise-receiver gain settings are measured, along with the corresponding load matches. Since all of the gain settings are measured during the calibration, the gain setting can be changed during the measurement if an overload indication occurs. Also during this step, the gamma values (i.e., the source match) of the ECal module used as an impedance tuner are also measured. In the third step, another ECal module or a suitable mechanical calibration kit is used to gather the normal S-parameter error terms. If the connectors on the ECal module exactly match those of the DUT, this is a single step. If not (e.g., the DUT is female-female and the ECal module is male-female), then two steps are required.

- Calibration uses sinusoidal and noise sources, plus cold terminations
- Some differences between high and low band calibrations
- Calibration sequence for simplest case (ECal connectors match DUT)
 - **Connect noise source to port 2**
 - Measure hot and cold noise power
 - Measure hot and cold match of noise source
 - **Connect through (ports 1 and 2)**
 - Measure gain differences between 0, 15, 30 dB settings
 - Measure load match of noise receivers
 - Measure Γ_s values of ECal used as impedance tuner
 - **Connect ECal (ports 1 and 2)**
 - Measure normal S-parameter terms
 - Measure receiver noise power with different Γ_s values using this ECal (tuner not used)
- Additional steps may be required
 - 1-port calibration to account for adapter if noise source is non-insertable
 - S-parameter calibration steps when ECal does not match DUT connectors
 - Source-power calibration using power meter when measuring frequency converters



Figure 38. Overview of vector-noise calibration using low-noise receivers and ECal module for S-parameter portion

The ECal module used for the S-parameter step is also used as an impedance tuner to measure receiver noise power with different source impedances, in order to determine the noise parameters of the receiver. This ECal module is used for the source-pulling of the noise receivers (rather than the ECal module used as the dedicated tuner) because there is less loss between it and the noise receivers, resulting in higher gamma values, which gives a better noise-parameter characterization.

Figure 39 shows the calibration procedure for vector-calibrated amplifier measurements when using the low-noise receivers and a mechanical calibration kit for the S-parameter portion of the calibration. The process is very similar to the one described in the previous figure. The main difference is that in this case, the measurements of receiver noise power versus source match are done in step two (using the ECal module configured as a tuner) and in step three (using a mechanical open, short, and load). Adding the measurements of receiver noise power with the mechanical standards gives more data for an over-determined solution, resulting in higher measurement accuracy.

- Calibration uses sinusoidal and noise sources, plus cold terminations
- Some differences between high and low band calibrations
- Calibration sequence for simplest case (insertable)
 - **Connect noise source to port 2**
 - Measure hot and cold noise power
 - Measure hot and cold match of noise source
 - **Connect through (ports 1 and 2)**
 - Measure gain differences between 0, 15, 30 dB settings
 - Measure load match of noise receivers
 - Measure Γ_s values of ECal used as impedance tuner
 - Measure receiver noise power with different tuner Γ_s values
 - **Connect calibration standards (ports 1 and 2)**
 - Measure normal S-parameter terms
 - Measure receiver noise power with open, short, load (more data for over-determined sol'n)
- Additional steps may be required
 - 1-port calibration to account for adapter if noise source is non-insertable
 - S-parameter calibration steps for non-insertable DUTs
 - Source-power calibration using power meter when measuring frequency converters

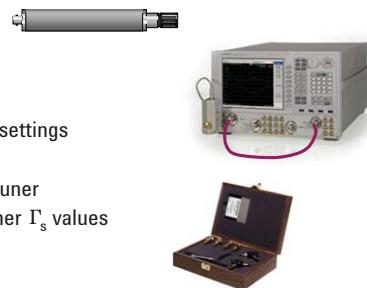

Figure 39. Overview of vector-noise calibration using low-noise receivers and mechanical kit for S-parameter portion

Standard receiver noise calibration

The calibration process has two changes when a standard receiver is used in place of a low-noise receiver. The first change is that a noise source is not used to characterize the noise contribution of the receiver. When characterizing low-noise receivers, a noise source provides the gain-bandwidth product of the receiver, which is required to calculate its noise-power contribution. However, this methodology does not work well when the noise figure of the receiver is much higher than the amount of excess noise produced by the noise source, which is the case when measuring a standard receiver. This problem can be overcome by measuring receiver gain and bandwidth separately, and mathematically computing the gain-bandwidth product. For the gain portion, a power meter is used as an absolute power reference in order to calibrate the receiver for correct sinusoidal power measurements. The noise bandwidth of the receiver is measured by performing a narrowband frequency sweep to determine the magnitude response of the IF filter, and then integrating the response to calculate the effective noise bandwidth. Since zero-IF mixing is used when measuring noise power, a double-peak response is seen on the screen during calibration, as shown in Figure 40.

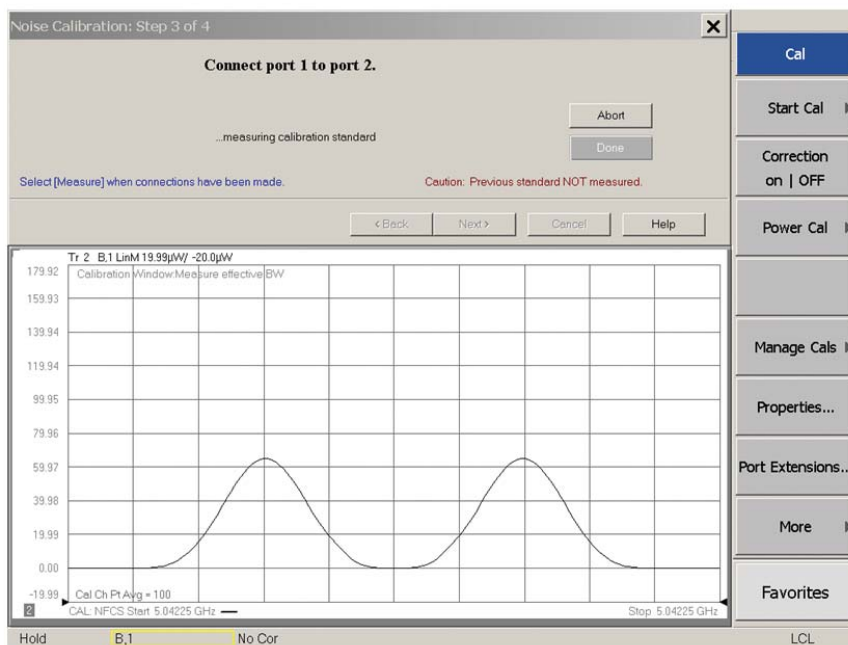

Figure 40. Measuring the effective noise bandwidth of a standard receiver during calibration

The second change to calibration when using a standard receiver is that only one gain measurement is needed, as the standard receivers do not have switchable amplifiers ahead of the mixer.

Scalar noise calibration

When performing a scalar noise calibration, measurements of the impedance states of the ECal used as an impedance tuner are omitted, since scalar-calibrated measurements assume a perfect 50-ohm source match. However, the source-pull measurements on the receiver used to measure noise power are still performed in order to do a more-accurate job of second-stage noise correction. When an ECal module is used for the S-parameter portion of the calibration, it is also used for the source pulling. When a mechanical calibration kit is used, the open, short, and load standards are used for the source pull. Since a minimum of four impedance standards are required to solve the noise parameters of the measurement receiver, an additional measurement is made during the through step where the raw source match of the test system is used as an additional impedance standard. The complex values of raw source match are determined as part of the S-parameter calibration.

Calibration for frequency converters

When measuring frequency converters, an extra step is added at the start of the calibration process, in which a power meter is connected to test port one. In this step, a source power calibration is performed which levels the source power versus frequency. The leveled power is later used to calibrate the standard receivers for absolute power measurements, which is necessary for measuring the conversion gain (or loss) of frequency converters. This methodology is the same as is used in the Scalar Mixer/Converter (SMC) measurement class.

On-wafer calibration

For vector-calibrated on-wafer measurements using the low-noise receiver, there are two ways in which to perform the calibration. In either case, the noise source cannot be at the same measurement plane as the DUT, since the coaxial connector of the noise source does not interface with the tip of the wafer probe. While the following two examples show how the noise source is connected during calibration, the approach of mixing coaxial and on-wafer calibration is also used when performing on-wafer measurements using a standard receiver and a coaxial power meter, or when measuring frequency converters, which also requires the connection of a power meter.

In the example shown in Figure 41, the noise source is connected directly to test port two of the PNA-X using a female-to-female (f-f) adapter. After the noise characterization is done, a one-port calibration is performed at the adapter plane, to establish the noise-calibration reference plane. For step three, the cable between port two of the PNA-X and the wafer probe is attached, leaving the f-f adapter in place. After the on-wafer two-port calibration is performed, the noise-calibration reference plane can be mathematically extended to the two-port calibration plane, using an embedding algorithm described in the following section. This example results in the best calibration of the PNA-X's internal low-noise receiver, since the loss between the noise source and test port two is minimized.

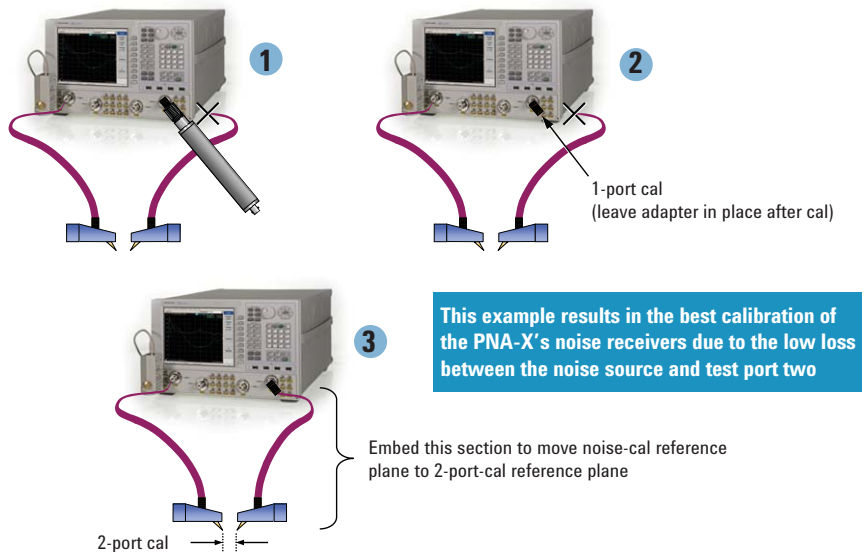

Figure 41. On-wafer noise calibration, example 1: connecting the noise source directly to the PNA-X front panel

In the example shown in Figure 42, the noise source is connected at the end of the cable used to connect the wafer probe to the analyzer, instead of directly at test port two of the analyzer. This may be more convenient due to the placement of the PNA-X, which, for on-wafer measurements, is often in an inaccessible location in a test rack behind the wafer-probe station. In this case, a f-f adapter is again needed to connect the noise source to the test system, and a one-port calibration with the adapter in place is done after the noise characterization to establish a noise-calibration reference plane. Unlike the previous example where the adapter stayed in place after the one-port calibration, here the adapter must be removed in order to connect the cable to the wafer probe. However, the embedding algorithm correctly extends the noise-calibration reference plane to the two-port calibration reference plane, even though the f-f adapter was removed.

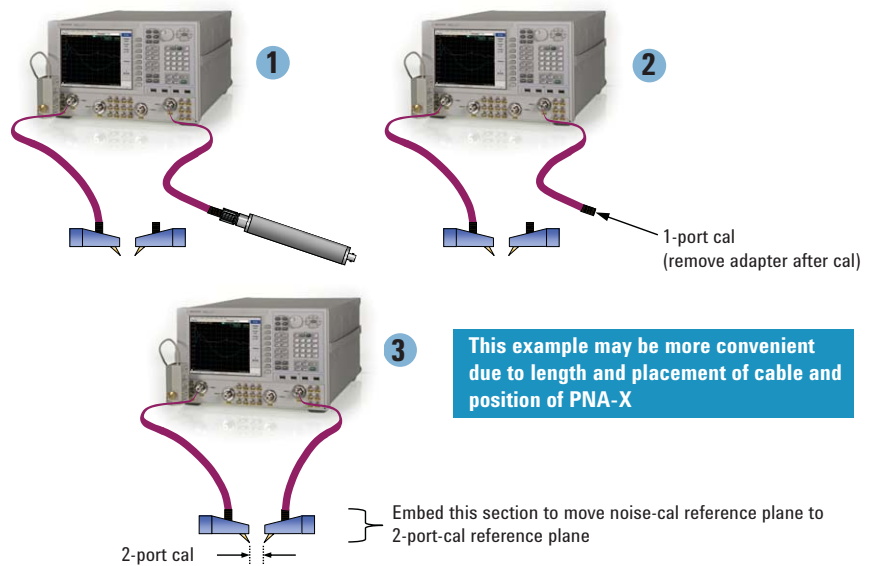

Figure 42. On-wafer noise calibration, example 2: connecting the noise source to the end of the coaxial test cable

Moving the noise calibration plane

In order to understand the previous calibration examples, where the noise calibration plane is moved to the tip of the wafer probe even though an adapter was removed, we need to explore how to move from one calibration plane to another. Consider the example shown in Figure 43, where Cal 1 is performed with a female-female barrel ([T_A]), and Cal 2 is done on-wafer [T_B]. For Cal 2, the wafer probe can be considered to be another adapter. Note that the characteristics of the test cable and VNA are the same in both cases, and are denoted as [T_{sys}], which are the combined T-parameters of the test port cable and the VNA. T-parameters, which are derived from S-parameters, are used because the associated math for dealing with cascaded networks is very simple. For example, two cascaded T-parameter networks can simply be multiplied together.

In order to move from calibration plane 1 (set by Cal 1) to calibration plane 2 (set by Cal 2), we need to calculate the T-parameters of a virtual adapter, which is denoted as [T_Δ]. This virtual adapter can be expressed as:

$$[T_{\Delta}] = [T_B] * [T_A]^{-1}, \text{ where } [T_A]^{-1} \text{ is the inverse of } [T_A].$$

However, since we don't directly have [T_B] or [T_A], we need to do some math to calculate [T_Δ] based on [T₁] and [T₂].

We know:

$$[T_1] = [T_A] * [T_{\text{sys}}] \text{ and } [T_2] = [T_B] * [T_{\text{sys}}].$$

Since [T_{sys}] is common, we can set up the following equation:

$$[T_{\text{sys}}] = [T_1] * [T_A]^{-1} = [T_2] * [T_B]^{-1}$$

Multiplying by [T_B], we get:

$$[T_B] * [T_1] * [T_A]^{-1} = [T_B] * [T_2] * [T_B]^{-1} = [T_2]$$

Multiplying by [T₁]⁻¹, we get:

$$[T_1]^{-1} * [T_B] * [T_1] * [T_A]^{-1} = [T_1]^{-1} * [T_2] \text{ or}$$

$$[T_B] * [T_A]^{-1} = [T_1]^{-1} * [T_2] = [T_{\Delta}]$$

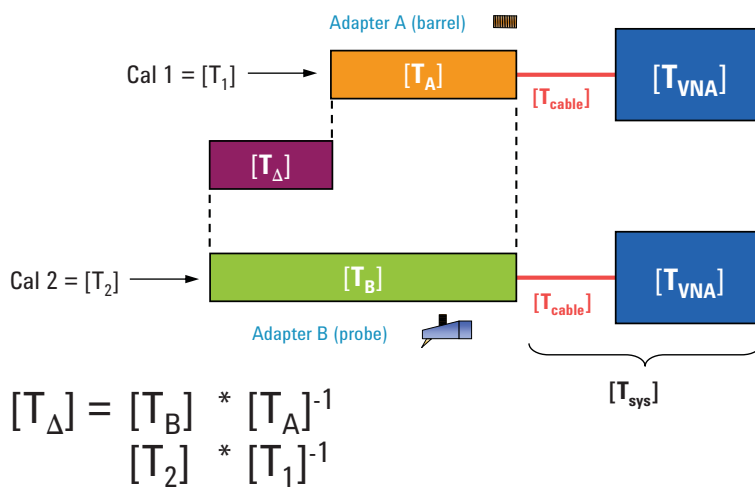

Figure 43. Moving the calibration plane between adapters

Practical Measurement Considerations

Ambient temperature setting

When setting up the noise figure measurement, the ambient temperature of the test system is needed to calculate the correct value of input noise power. This value, which is entered in the Noise Figure Setup dialog (Figure 26), should represent the average temperature of all of the components looking back from the calibration plane towards the PNA-X, including the components behind the instrument test port. A good starting value is the ambient temperature, which is typically 298 K, but can be accurately determined with a precision thermometer. Although the ECal is internally heated to 304 K, the loss between the ECal and the DUT generally negates its temperature rise above ambient. There might be a little heating from the instrument, so 299 K or 300 K might be a better estimate. Note that the difference between using 298 and 300 K is only about 0.7%, which equates to a change in noise figure of only .03 dB.

When using a noise source during calibration, there is an entry box in the calibration wizard where you can specify the actual temperature of the noise source. Since the noise source is kept on when connected to the PNA-X, it is typically a few degrees K warmer than the ambient temperature.

Noise averaging

Noise averaging is an important measurement condition to consider when making noise figure measurements with the PNA-X. When noise averaging is not used, (the same as using a value of one), there are still many underlying analog-to-digital-converter (ADC) samples taken for each noise power measurement, in order to estimate the average noise power hitting the noise receiver. The amount of ADC samples is arbitrary, and the PNA-X uses approximately 10,000 samples when using the low-noise receivers. When noise averaging is used, the averaging value multiplies the number of ADC values taken, which gives a better estimate of average noise power by lowering the jitter on the trace, but at the expense of increased measurement speed. During calibration, it is highly recommended to use noise averaging, with a value between 10 and 20 when using the low-noise receivers, and a value of 50 to 100 when using the standard receivers. This will result in a clean calibration. When measuring the DUT, the number of noise averages can be decreased to trade off measurement speed and accuracy. The more gain the DUT has, the less need for noise averaging during the measurement. If noise averaging is not used during calibration, then the noise present during the calibration cannot be removed from subsequent measurements, even if noise averaging is later turned on.

When using the standard receivers for noise figure measurements, only two noise bandwidths are available, 720 kHz, and 1.2 MHz, instead of the five settings available with the low-noise receiver, covering 0.8 to 24 MHz. Smaller noise bandwidths mean more jitter on the measurement, requiring more averaging.

Measuring noise figure of a through

Figure 44 shows four different PNA-X-based NF measurements of a through using the low-noise receivers, with different amounts of noise averaging (with the default 4 MHz noise bandwidth). This is a very difficult measurement for the cold-source method, because there is no excess noise going into the noise receivers since the DUT (a through in this case) has no gain and no excess noise. This means that the second-stage noise-correction algorithm is subtracting two noisy signals with the same average power. For the PNA-X with no noise averaging, the noise figure measurement is very fast and the average value is 0 dB as expected, but the jitter (trace noise) is quite high. Increasing the noise averaging to ten gives a very large decrease in jitter and a corresponding improvement in accuracy. Twenty averages gives even better results. The improvement using forty averages is not as dramatic. When using the low-noise receivers, ten to twenty averages is a good compromise between speed and accuracy, and this amount of averaging should always be used during a noise-figure calibration (when using the standard receivers, use between fifty and one hundred averages). It should be noted that these levels of jitter are much higher than those that occur with the same amount of averaging used for a device with gain.

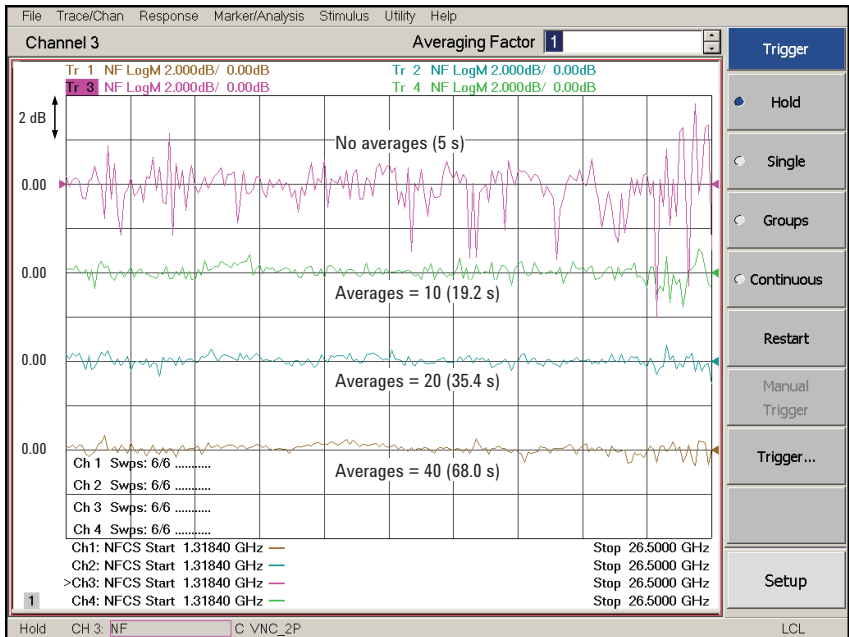

Notes: points = 201; avg used during cal and measurement; traces offset by two graticules for clarity

Figure 44. Measuring noise figure of a through, with different noise-average values

Figure 45 shows a noise figure comparison of a through using an NFA (using the Y-factor method) and a PNA-X (using the cold-source method with low-noise receivers) with similar measurement times. For the PNA-X, twenty noise averages was used to get approximately the same integration time as the NFA. As can be seen, the jitter for both measurements is about the same. The PNA-X's average value is closer to the expected value of 0 dB due to a better measurement of the gain of the DUT, which in this case is 0 dB.

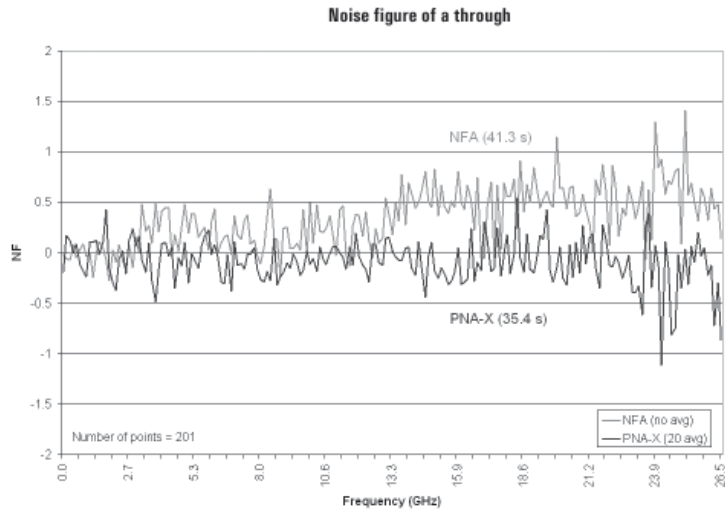
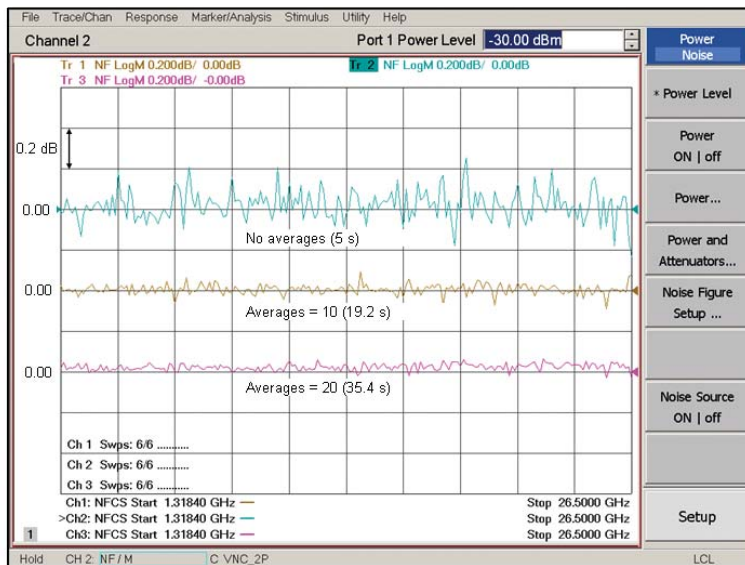

Figure 45. Measurements of a through, comparing a PNA-X with low-noise receiver and an NFA

Measuring noise figure of an amplifier

Figure 46 shows three different PNA-X noise figure measurements of an amplifier with 15 to 20 dB of gain, using the low-noise receivers with different amounts of noise averaging. Note that the scale in this example is 0.2 dB per division, whereas in the previous example of measuring a through, the scale was 2 dB per division. With ten to twenty averages, the jitter is quite low.



Notes: DUT = 83017A with 20 dB pad on output; number of points = 201; averaging used during calibration and measurement; data normalized (data/memory) to remove slope; traces offset by two graticules for clarity

Figure 46. Measuring noise figure of an amplifier using low-noise receiver with different noise-average values

Measuring low gain or lossy devices

The PNA-X is quite capable of measuring devices with low gain and low noise figure. To illustrate this, Figure 47 shows measurements on a device that has no gain and no excess noise – a 40 dB attenuator. This measurement is very difficult or impossible using the Y-factor method, since the difference in noise between the hot and cold states of the noise source is reduced to a very small amount by the attenuator. This example is only used to demonstrate the validity of the cold-source method, since in the real world, no one measures the noise figure of attenuators, since the noise figure of an attenuator is always equal to its loss. Note that the noise figure is the mirror image of S_{21} in log format, which is correct since noise figure is always positive and log-magnitude of S_{21} is always negative for an attenuator. The reference levels between the S_{21} and noise figure measurements are the negative of each other so that the two traces can be viewed together. Note that fifty noise averages was used to get the jitter to an acceptable value.

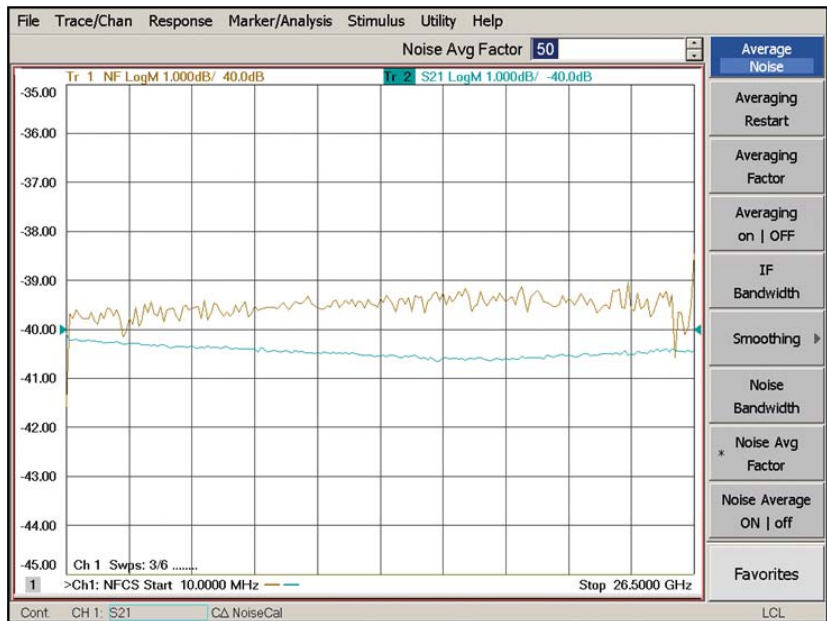

Figure 47. Measuring noise figure of a 40 dB attenuator

Optimizing S-parameter power level

Since noise figure measurements are often made on high-gain amplifiers and converters, the port power used during the S-parameter or conversion-gain portion of the noise figure measurement is often low. There are two things that can be done to improve measurement accuracy involving port power. The first is to uncouple the port powers, and use a higher port power for the port of the PNA-X that is connected to the output port of the DUT. Measuring S_{22} of the DUT is necessary for the second-stage noise correction, so this power level should be high enough to ensure a reflection measurement with good SNR. For most devices, even if the input power must be low, the reverse power can be considerably higher without causing damage. Typically, the reverse port power is set to a value about 5 dB below the power present at the DUT output when driven in the forward direction during the noise figure measurement.

The second thing to improve accuracy is to increase the power at port one during calibration, and then reduce it for the measurement of the DUT. This means that the source attenuator setting for port one should be as small as possible while still guaranteeing that the port power can be dropped to the necessary level for the measurement. Using a smaller value of attenuation means that the port power can be increased more during calibration, providing a better SNR and therefore decreased trace noise.

When making noise figure measurements using the standard receivers and an external preamplifier, the gain of the preamplifier must be taken into account when setting the measurement and calibration power levels to avoid compressing the measurement receiver. If the test port coupler is reversed, the power sent to the receiver is increased by at least 15 dB compared to the normal configuration, so care must also be taken in this case to avoid receiver compression. In general, to avoid compression of the standard receivers, the power delivered to the test port should be less than +10 dBm with the normal jumper configuration, and less than -5 dBm when the test port coupler is reversed.

Optimizing power sensor level during calibration

When measuring noise figure of a frequency converter or when using a standard receiver, a power sensor is used during the calibration process to calibrate the PNA-X receivers. Figure 48 shows that the power level used for this calibration step can be set independently from the channel power used for the S-parameter portion of the calibration and measurement. For the highest measurement accuracy, the power sensor should be used at the same power level used during its calibration, which is typically 0 dBm. This removes the power-sensor linearity error from the overall measurement uncertainty. The PNA-X receivers are quite linear (more linear than a power sensor), so they can be calibrated at the higher power level and still be very accurate when measuring lower power levels during the measurement. Depending on how much source attenuation is present and the frequency range of the measurement, it may not be possible to achieve 0 dBm during the calibration. In this case, set the power as high as possible without causing the source to go unlevelled.

When measuring very high gain devices that require large amounts of source attenuation (in order to set the measurement power low enough to avoid compressing the DUT), the maximum available power might be below the power sensor's measurement range, which would cause the power calibration to fail. In this case, the source attenuator can be set to a smaller value to allow more power during calibration, and an external attenuator can be placed at the input of the DUT to lower the power during the noise figure measurement. The effect of the attenuator on the noise figure results can be removed by de-embedding the attenuator's S-parameters, which must be measured separately ahead of time.



Figure 48. When using a power meter during calibration, the power level can be optimized independently from the channel power

Compression and damage levels

Just as is done for S-parameter measurements, it is important to make sure the receivers used for noise figure measurements are not compressed. This is especially important when using the PNA-X's low-noise receivers, as they have much more gain than the standard receivers. When considering compression for noise measurements, one must take into account both the gain and the bandwidth of the DUT. As DUT gain or bandwidth increases, so does the amount of output noise power. When using the low-noise receivers with wideband devices, compression is likely to occur in the front-end amplifiers first. For narrowband devices, the analog-to-digital converter (ADC) at the back end of the receiver is likely to over-range before the front end compresses. The low-noise receivers in the PNA-X have diode detectors at the front end to detect compression. The instrument's firmware will report warnings if the front-end overloads or if ADC over-range occurs. If the warning occurs briefly during the measurement, it might be the result of interference (see next section), but if the warning shows continuously, then the gain of either the noise receiver or the DUT must be reduced. Note that changing the receiver gain after a calibration does not invalidate the results, since all three gain settings are measured during the calibration process. If the receiver is already at the low-gain setting, then there are two choices: use an attenuator on the output of the DUT (which won't affect the DUT's measured noise figure) or use a standard receiver. If an attenuator is used, it can be de-embedded so that the measured S_{21} of the DUT is correct. Compression due to noise is not likely to be a problem when using the standard receivers, due to their lack of front-end amplifiers. However, when the test port coupler is reversed, the power sent to the receiver is increased by at least 15 dB compared to the standard configuration, so care must also be taken with the S-parameter power levels to avoid receiver compression.

When measuring mixers or frequency converters, extra filtering at the output of the DUT may be necessary to remove LO feed-through or other spurious signals that would otherwise cause receiver compression.

The noise figure uncertainty calculator is a useful tool to check for compression. It reads in the data from a noise figure measurement and shows how far the measured noise power was from the receiver's noise floor and compression level, as shown in Figure 49.

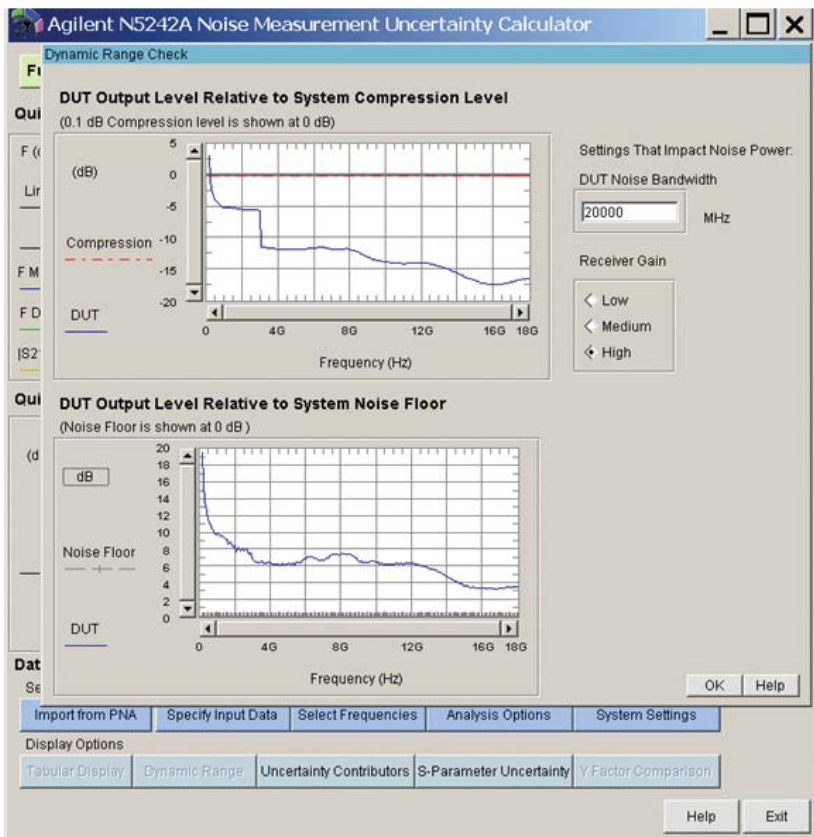

Figure 49. Agilent's PNA-X noise figure uncertainty calculator shows if the DUT's noise power is causing compression in the noise receiver.

When using the low-noise receivers, the damage level of port two of the PNA-X is reduced from +30 dBm to +25 dBm. This reduction is due to the LNA of the noise receiver, which is more sensitive than the mixers found in the standard receivers.

Interference

When measuring the noise figure of an unshielded device, like an amplifier on a printed-circuit board, it is very common to pick up electromagnetic interference from external signals such as cellular/mobile phones, wireless LAN routers or clients, or mobile radios. This interference shows up as non-repeatable spikes in the measurement, as shown in Figure 50. Usually the interference only adversely affects the noise figure measurement at the frequency where it occurs. However, if the interference is large enough and present all of the time, it can cause the noise receivers to compress, which results in inaccurate measurements. If this occurs, one way to address the problem is to lower the receiver gain of the PNA-X, if possible. The best way however, is to perform the noise figure measurements in a shielded environment, for example, in a screen room.

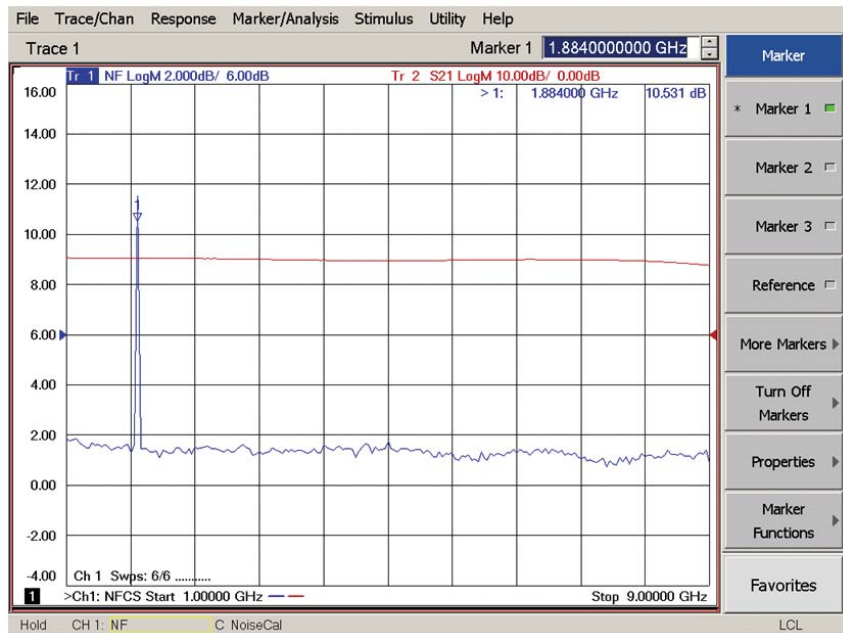

Figure 50. Electromagnetic interference usually shows up as large spikes in the noise figure measurement.

Additional Resources

Application notes

Fundamentals of RF and Microwave Noise Figure Measurements, Application Note 57-1 (Agilent literature number 5952-8255E)

Noise Figure Measurement Accuracy – The Y-Factor Method, Application Note 57-2 (Agilent literature number 5952-3706E)

10 Hints for Making Successful Noise Figure Measurements, Application Note 57-3 (Agilent literature number 5980-0288EN)

Practical Noise-Figure Measurement and Analysis for Low-Noise Amplifier Designs, Application Note 1354 (Agilent literature number 5980-1916EN)

Noise Figure Measurements of Frequency Converting Devices Using the Agilent NFA Series Noise Figure Analyzer, Application Note 1487 (Agilent literature number 5989-0400EN)

Magazine articles

Ballo, David. "Overcoming Noise Figure Measurement Challenges in Fixtured, On-Wafer and ATE Environments". *Microwave Product Digest*, May 2008

Gary Simpson and David Ballo. "Ultra-fast, Simpler and More Accurate Noise Parameter Measurements". *Microwave Journal*, March, 2010 (Vol. 53, No. 3): p. 82+

Papers

James Randa, Ken Wong, and Roger Pollard. "Simulations of Noise-Parameter Verification Using Cascade with Isolator or Mismatched Transmission Line". *70th ARFTG Microwave Measurements Conference Digest*, November 2007, pp. 77 – 83

Web

More information about the PNA-X, including a noise figure FAQ can be found at www.agilent.com/find/pnax

An overview of the user interface for the PNA-X noise figure options can be found in the Help file located at na.tm.agilent.com/pna/help/index.html

Agilent's PNA-X noise figure uncertainty calculator can be downloaded from www.agilent.com/find/nfu



Agilent Email Updates

www.agilent.com/find/emailupdates

Get the latest information on the products and applications you select.



www.lxistandard.org

LXI is the LAN-based successor to GPIB, providing faster, more efficient connectivity. Agilent is a founding member of the LXI consortium.

Agilent Channel Partners

www.agilent.com/find/channelpartners

Get the best of both worlds: Agilent's measurement expertise and product breadth, combined with channel partner convenience.

Application Note 1408-20



Agilent Advantage Services is committed to your success throughout your equipment's lifetime. We share measurement and service expertise to help you create the products that change our world. To keep you competitive, we continually invest in tools and processes that speed up calibration and repair, reduce your cost of ownership, and move us ahead of your development curve.

www.agilent.com/find/advantageservices



www.agilent.com/quality

www.agilent.com
www.agilent.com/find/pna

For more information on Agilent Technologies' products, applications or services, please contact your local Agilent office. The complete list is available at:

www.agilent.com/find/contactus

Americas

Canada	(877) 894 4414
Brazil	(11) 4197 3500
Latin America	305 269 7500
Mexico	01800 5064 800
United States	(800) 829 4444

Asia Pacific

Australia	1 800 629 485
China	800 810 0189
Hong Kong	800 938 693
India	1 800 112 929
Japan	0120 (421) 345
Korea	080 769 0800
Malaysia	1 800 888 848
Singapore	1 800 375 8100
Taiwan	0800 047 866
Thailand	1 800 226 008

Europe & Middle East

Austria	43 (0) 1 360 277 1571
Belgium	32 (0) 2 404 93 40
Denmark	45 70 13 15 15
Finland	358 (0) 10 855 2100
France	0825 010 700*
	*0.125 €/minute
Germany	49 (0) 7031 464 6333
Ireland	1890 924 204
Israel	972-3-9288-504/544
Italy	39 02 92 60 8484
Netherlands	31 (0) 20 547 2111
Spain	34 (91) 631 3300
Sweden	0200-88 22 55
Switzerland	0800 80 53 53
United Kingdom	44 (0) 118 9276201

Other European Countries:

www.agilent.com/find/contactus

Revised: July 8, 2010

Product specifications and descriptions in this document subject to change without notice.

© Agilent Technologies, Inc. 2010
Printed in USA, September 16, 2010
5990-5800EN



Agilent Technologies