

# TestJet/VTEP Hardware Description and Verification

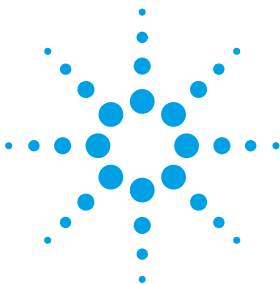

Application Note

# Contents

## 1. TestJet/VTEP Hardware Description ... 3

<b>TestJet Hardware Components</b> .....	<b>3</b>
TestJet MUX Card .....	3
TestJet AMP Board .....	3
TestJet Sensor Plate .....	4
<b>VTEP Hardware Components</b> .....	<b>4</b>
VTEP MUX Card .....	4
VTEP AMP Board .....	5
VTEP Sensor Plate .....	5
<b>VTEP Installation: Best Practices</b> .....	<b>6</b>
VTEP Clip Application .....	9
VTEP CLIP Parts Needed .....	9
VTEP Clip installation .....	10
VTEP Clip inside the fixture .....	7

## 2. TestJet/VTEP Fixture Verifier ..... 13

<b>What's New in Revision 5.2 TestJet/VTEP</b> .....	<b>13</b>
<b>Fixture Verifier Setup</b> .....	<b>14</b>
Software Installation .....	14
Hardware Installation .....	14
<b>Set Up for Testing</b> .....	<b>17</b>
<b>Test Procedure</b> .....	<b>19</b>

## 3. Installation Scenarios and Verifier Results.....20

<b>Verification of TestJet Hardware Installation</b> .....	<b>20</b>
<i>Scenario 1:</i> Correct Installation .....	21
<i>Scenario 2:</i> Incorrect hanger probe connections on port 2 .....	22
<i>Scenario 3:</i> Hanger probes on wrong side of AMP board .....	23
<i>Scenario 4:</i> Port 2 sensor plate is reverse .....	24
<i>Scenario 5:</i> VTEP AMP board and sensor plate installed on port 2 .....	25
<i>Scenario 6:</i> VTEP AMP board and sensor plate installed on port 2; hanger probes are reversed .....	26
<i>Scenario 7:</i> Port 2 has VTEP AMP board and sensor plate; hanger probes on wrong side of board .....	27
<i>Scenario 8:</i> VTEP AMP board and sensor plate installed on port 2; hanger probes on wrong side of board and reversed .....	28
<b>Verification of VTEP Hardware Installation</b> .....	<b>29</b>
<i>Scenario 1:</i> Correct Installation .....	30
<i>Scenario 2:</i> Incorrect hanger probe connections on port 2 .....	31
<i>Scenario 3:</i> Hanger probes on wrong side of AMP board .....	32
<i>Scenario 4:</i> Port 2 sensor plate is reversed .....	33
<i>Scenario 5:</i> Port 2 has TestJet AMP board and sensor plate .....	34
<i>Scenario 6:</i> Port 2 has VTEP AMP board and sensor plate; hanger probes are reversed .....	35
<i>Scenario 7:</i> TestJet AMP board and sensor plate installed on port 2; hanger probes on wrong side of board .....	36
<i>Scenario 8:</i> TestJet AMP board and sensor plate installed on port 2; hanger probes on wrong side of board and reversed .....	37

# 1. TestJet/VTEP Hardware Description

TestJet Hardware Components .....3  
 VTEP Hardware Components .....4  
 VTEP Installation: Best Practices .....6

This chapter describes the TestJet and VTEP hardware components and the required connections for assembly on test fixtures.

## TestJet Hardware Components

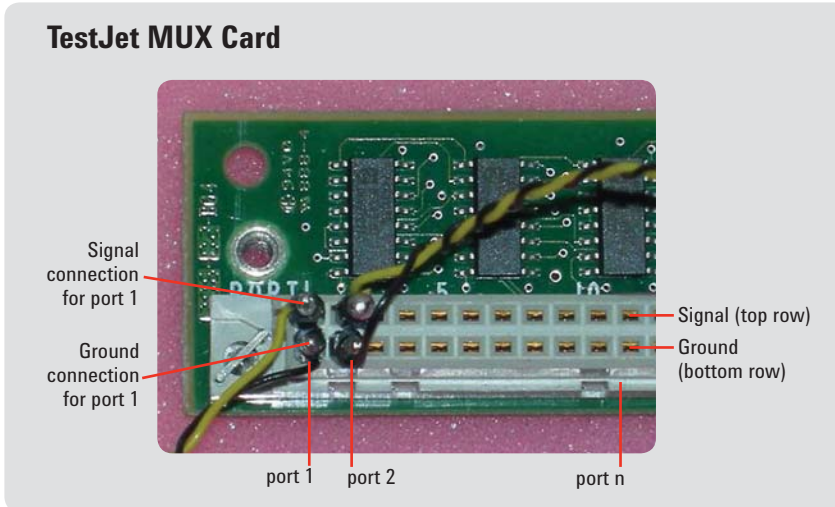

Figure 1. TestJet MUX card – signal and ground connections to AMP board

- There are 64 ports on two connectors, J2 and J3, on the MUX card (port 1 to 32 on J2 and port 33 to 64 on J3).
- The first row of the connectors are signals and the second row belongs to ground.
- The ports are configured in columns; each port consists of signal and ground connections to the AMP board.

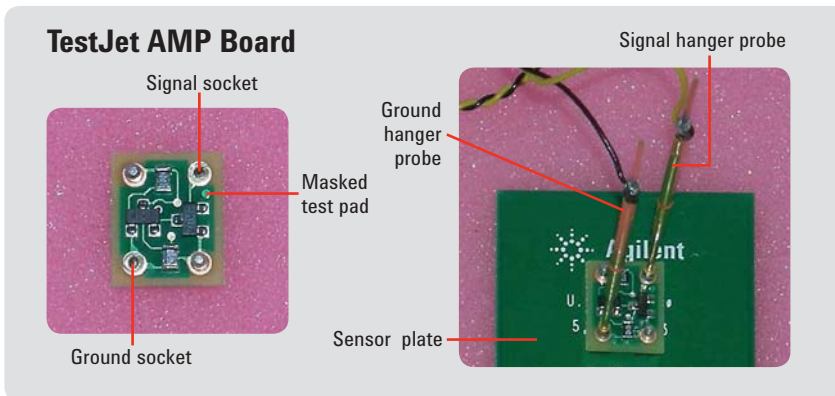

Figure 2. AMP board – connections to hanger probes

- Hanger probes must be installed correctly on the AMP board. The correct side for installation is identified by the masked test pad (Figure 2).
- The socket for the signal hanger probe is near the masked test pad.
- The socket for the ground hanger probe is at the opposite corner of the AMP board.

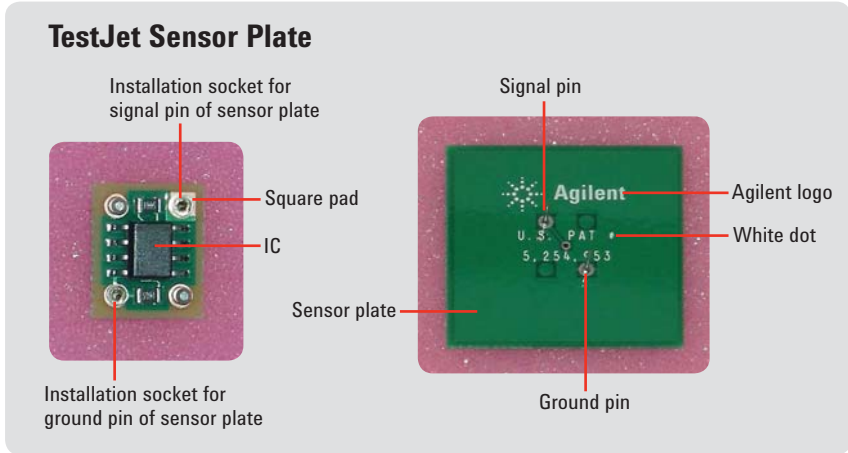

Figure 3. Sensor plate – connections to AMP board

- The AMP board must be installed correctly on the sensor plate. The correct side for installation is identified by the IC on the AMP board (Figure 3).
- Signal pin and socket
- On the sensor plate, the signal pin is near the Agilent logo.
- On the AMP board, the socket for the signal pin is located on a square pad.
- Ground pin and socket
- On the sensor plate, the ground pin on the sensor plate is diagonally opposite the sensor pin.
- On the AMP board, the socket for the signal pin is at the opposite corner from the ground socket.

## VTEP Hardware Components

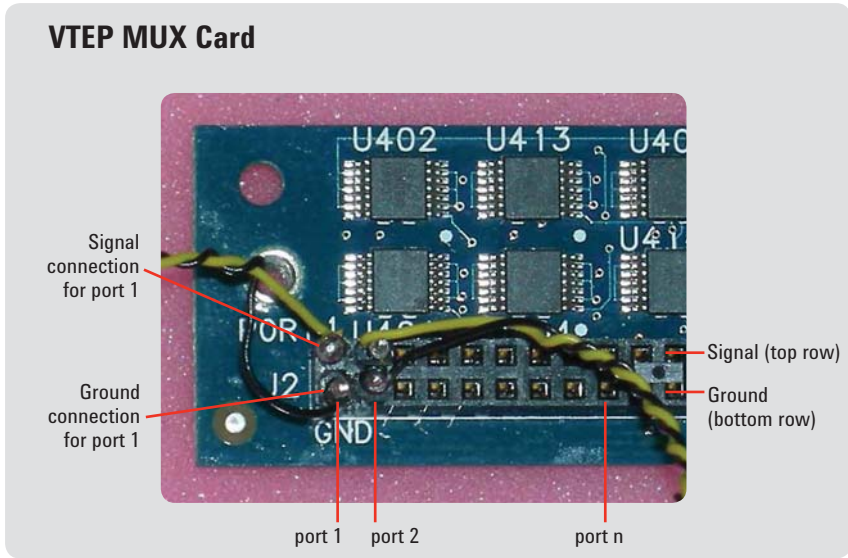

Figure 4. VTEP MUX card – signal and ground connections to AMP board

- There are 64 ports on two connectors, J2 and J3 on the MUX card (port 1 to 32 on J2 and port 33 to 64 on J3).
- The first row of the connectors are signals and the second row belongs to ground.
- The ports are configured in columns; each port consists of signal and ground connections to the AMP board.

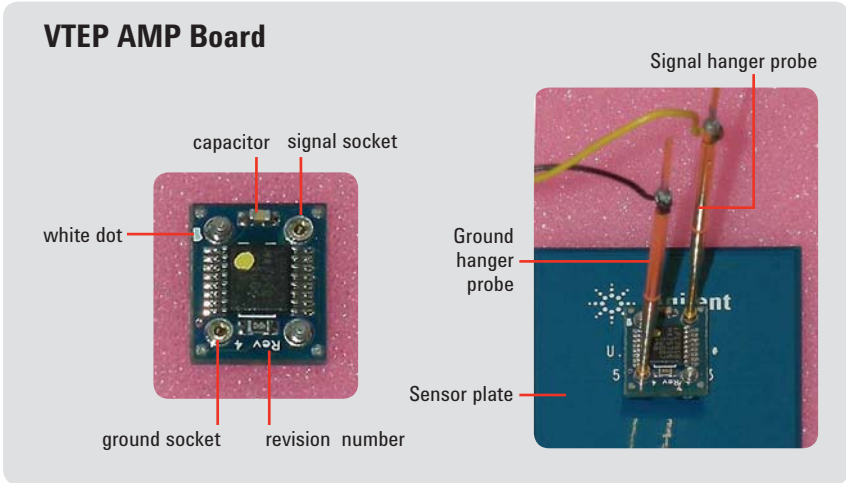

Figure 5. AMP board – connections to hanger probes

- Hanger probes must be installed correctly on the AMP board. The correct side for installation is identified by the IC (Figure 5).
- The socket for the signal hanger probe is near the capacitor.
- The socket for the ground hanger probe is at the opposite corner of the AMP board, near the revision number.

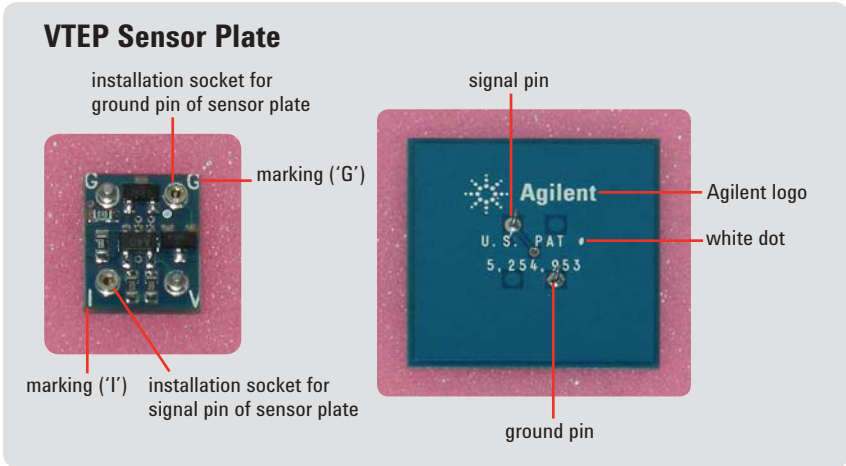

Figure 6. Sensor plate – connections to AMP board

- The AMP board must be installed correctly on the sensor plate. The correct side for installation can be identified by the letters at the corners of the AMP board (Figure 6).
- Signal pin and socket
  - On the sensor plate, the signal pin is near the Agilent logo.
  - On the AMP board, the socket for the signal pin is near the 'I' marking.
- Ground pin and socket
  - On the sensor plate, the ground pin is diagonally pposite the sensor pin.
  - On the AMP board, the socket for the signal pin is near the 'I' marking.

## VTEP Installation: Best Practices

1. Do not mix VTEP and TestJet components in a fixture.  
VTEP and TestJet part numbers are given in Table 1.

Table 1. VTEP and TestJet part numbers

Fixture components	TestJet part number	VTEP part number
Mux	E3849A	N4300A
Mux + Ref	E3969A	N4307A
Probes (amp boards)	E3850A/E3960A	N4301A/N4313A
Connector sensor plates	E3064A	N4306A
1.2" sq. sensor plates	E3853A	N4302A
2.5" sq. sensor plates	E3854A	N4303A
Small probes (small amp boards)	E3845A/E3847A	N4311A/N4312A
B-C polarity check sensor plates	E3891A	
D polarity check sensor plates	E3892A	

2. Use only Agilent parts.
3. The size of the sensor plate should be smaller than the BGA ICs, to reduce coupling to other components and PCB traces. It should be  $0.8 \times$  BGA width or smaller.  
Bigger sensor plates on BGA ICs can contribute to a capacitive coupling effect on measurement from nearby components and traces (Figure 7).

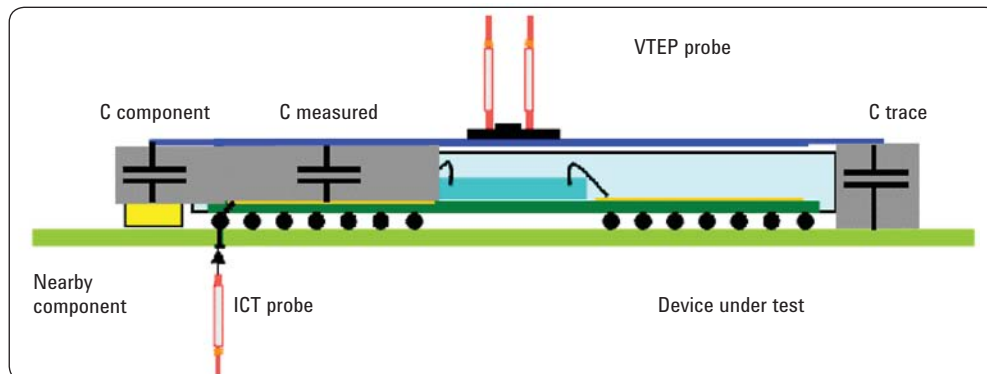

Figure 7. VTEP probes and sensor plates.

4. Sensor plates should be attached to VTEP AMP boards directly with correct polarity. Adding wire in between the connections can inject significant noise into the measurement, causing errors in the readings.

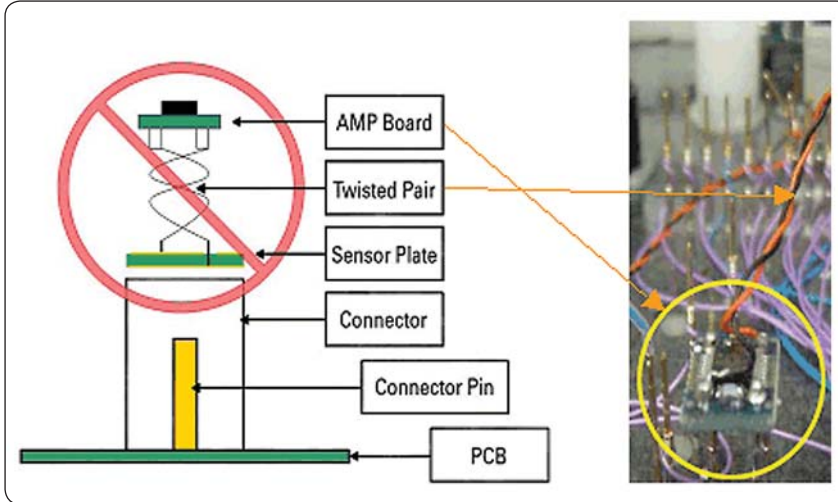

Figure 8. Sensor plate attachment to VTEP AMP boards.

5. VTEP AMP boards can be milled (Figure 9) to avoid contact with nearby probes in the bottom plate. It must be done carefully so that the trace is not cut accidentally.



Figure 9. VTEP AMP board

6. Use twisted pair wires to connect AMP boards to the VTEP MUX card. The wiring path between the MUX card and AMP board hanger probes must be as short as possible to ensure good quality signal measurement.

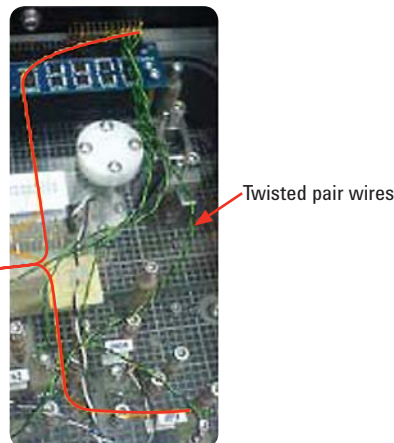

Figure 10. Wiring path between MUX header and hanger probe

7. If both sides of the DUT are to be tested with VTEP, use separate MUX cards for top and bottom to minimize the resistance between the MUX card and sensor plate.

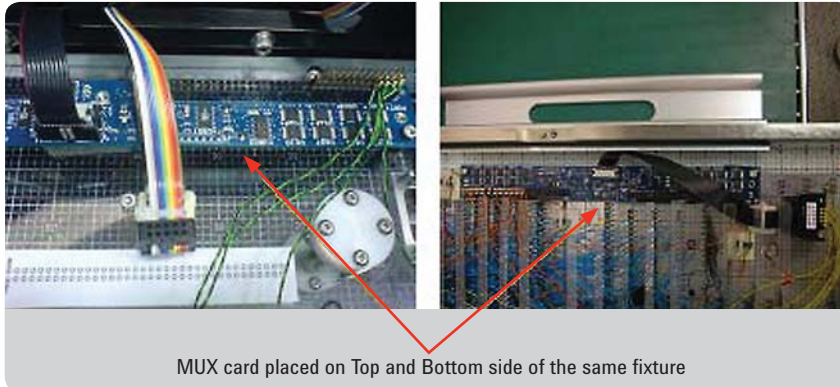

Figure 11. MUX card placement

8. Use a flex cable to connect the MUX card directly to the tester's BRC without using transfer pins (if MUX card is placed on the top side of the fixture).
9. Installation must be done in an ESD controlled environment. VTEP parts are merely PCBAs where the components (especially ICs) are susceptible to damage by electrostatic discharge, unlike those packaged in a box.  
  
Parts exposed to electrostatic discharge can often pass through tests initially, but fail to function after a few cycles.  
  
A stringent process control during storage (if stocked), parts movement, unpacking and installation is vital to eliminate the risk of damage.
10. Agilent ICT systems have the capability to verify TestJet/VTEP parts effectively. This will ensure that the TestJet/VTEP parts are good and installation is done properly. Issue the commands `verify all mux cards` and `verify mux [address] port [number]` in the BT- Basic command line to help detect faulty parts, wrong orientation and/or incorrect installation of VTEP components at an early stage.  
  
Ideally, fixture vendors should have at least a tester for fixture validation, program development and debug.
11. The TestJet/VTEP Fixture Verifier can be used as a tool for bench testing when an Agilent ICT tester is not available.
12. Ensure that VTEP parts are used within the warranty period to allow customers to get replacement parts if the parts are found to be faulty. Parts cannot be replaced after the warranty period. Any parts ordered must be utilized within a short period of time upon receipt.  
  
It is noted that fixture vendors with a record of no faulty VTEP parts are those who do not keep stock but order and install parts within a week of receipt.



## VTEP Clip Application

This section discusses the installation procedure for adding the VTEP clip to the VTEP amplifier board, sensor plate and hanger probes assembly for Agilent Medalist in-circuit test systems.

In order to hold the sensor plate to the amplifier, a VTEP clip is needed. The installation process is as described below:

## VTEP CLIP Parts Needed

### Parts needed

- VTEP amplifier board
- VTEP sensor plate
- Hanger probes (2 pieces)
- VTEP clip<sup>1</sup> AB (AB = amplifier board)
- VTEP clip<sup>1</sup> SP (SP = sensor plate)

<sup>1</sup> Physical part is in black color

### User-supplied items:

- 3M Scotch-Weld CA40 or equivalent cyanoacrylate instant adhesive
- Isopropyl alcohol

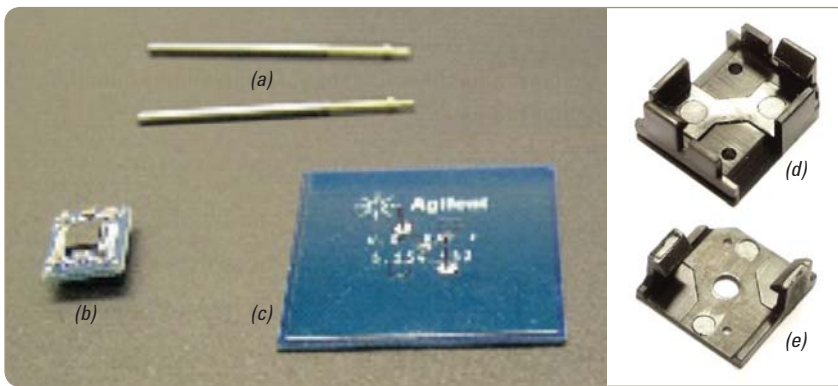

Figure 12. (a) Hanger probes (2x) 8710-2073 (b) VTEP Amp board N4301-66538 (c) Sensor plate (1.2x1.2, 2.5x2.5 or 6x0.5 inch) (d) VTEP clip AB (e) VTEP clip SP



Figure 13. User supplies needed, (f) adhesive, (g) isopropyl alcohol swipecard.

		Parts Included		
Product Number	Product Description	VTEP amplifier board	VTEP clip AB	VTEP clip SP
N4301A-FG	N4301A, VTEP probe set, new Pack of 50	Yes	Yes	Yes
N4313A-FG	N4313A, VTEP probe set, regular Pack of 250	Yes	Yes	Yes
N4319A-FG	N4319A, VTEP probe set Pack of 10	Yes	Yes	Yes
N4308A-001	FIX VTEP, Clip for probes Pack of 250	No	Yes	No
N4308A-002	FIX VTEP, Clip for probes Pack of 750	No	Yes	No
N4308A-003	FIX VTEP, Clip for sensor plates Pack of 250	No	No	Yes
N4308A-004	FIX VTEP, Clip for sensor plates Pack of 750	No	No	Yes

# VTEP Clip installation

## Step 1

Clean the surfaces of the VTEP clip SP and the VTEP sensor plate with isopropyl alcohol as indicated in the pictures.



Figure14. Wipe the surfaces

## Step 2

After the cleaned surfaces have dried, apply a very small amount of instant adhesive to the sensor plate on the two locations indicated by the red circles in the pictures below.



Figure 15. Apply adhesive (as denoted by the red circles)

## Step 3

Assemble the VTEP clip SP onto the sensor plate. Press down and hold the clip firmly for at least 30 seconds until the adhesive has cured. (Curing time depends on instant adhesive used.)

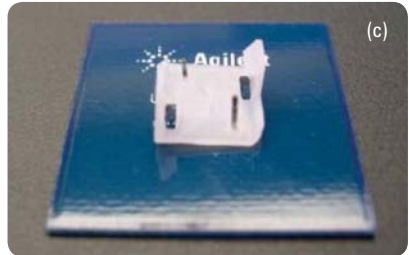

Figure16. Assembly process

## Important Note: Polarity of VTEP Clips

The VTEP clips have a chamfered corner. This corner is used to identify the signal side of the VTEP sensor plate and amp board.

When installing the VTEP clip, please make sure that the chamfer is always in the corner of the signal pin of both the VTEP sensor plate and also the VTEP amplifier board.

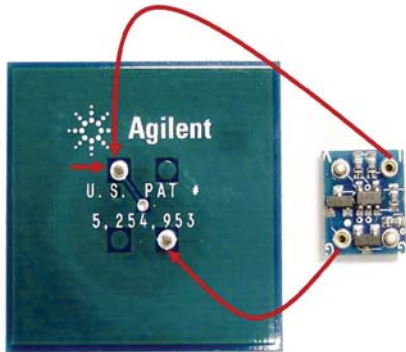

Figure 17(a). VTEP sensor plate and VTEP amp board

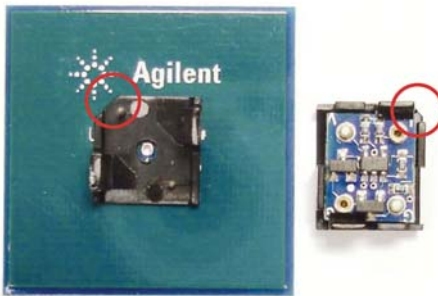

Figure 17(b). VTEP sensor plate and VTEP amp board with VTEP clips installed. Note position of chamfered corner.

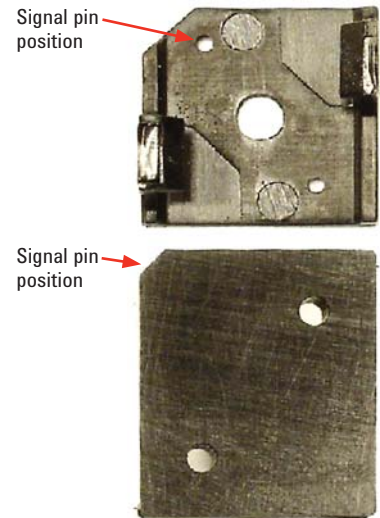
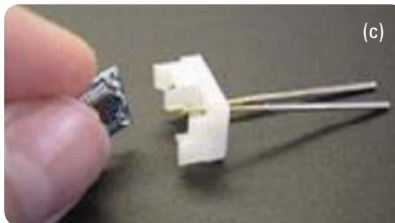

Figure 18. VTEP clip SP and VTEP clip AB

## Step 4

Assemble the VTEP clip AB and the two hanger probes. Align the VTEP amplifier board with the hanger probes and snap in the amplifier board, so that the amplifier board is secured by the two snap hooks of the VTEP clip AB.



*Note: Please exercise ESD precautionary measures when installing amplifier boards to snap hooks on VTEP clip AB.*

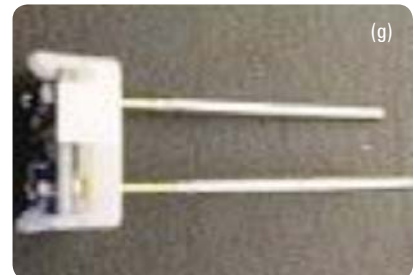
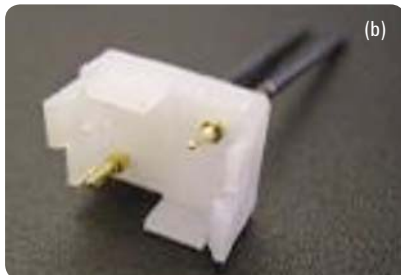
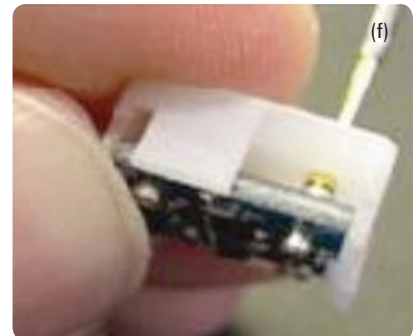
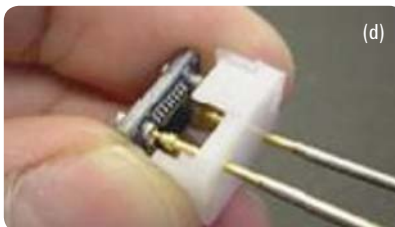
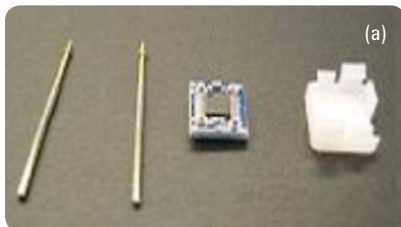

Figure 19. Final assembly

## Step 5

Align the probes of the sensor plate with the corresponding socket on the amplifier board. Press down the amplifier board assembly firmly on the sensor plate assembly until it snaps into place.

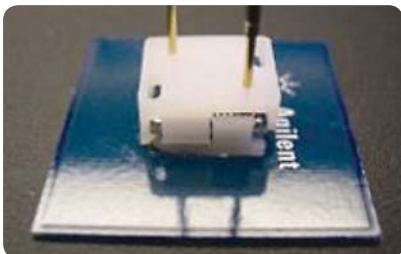
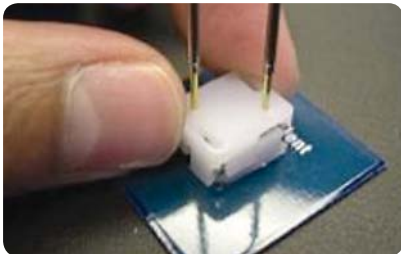
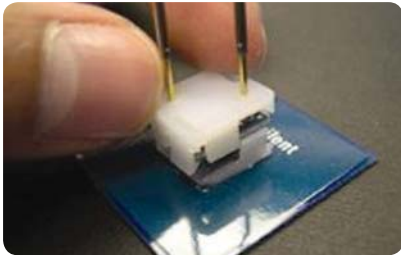
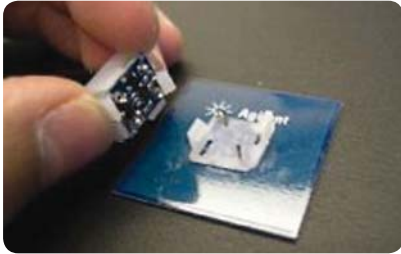

Figure 20. Final assembly

## Final assembly

The three pictures below show the final assembly of the VTEP amplifier board and sensor plate with the clips.

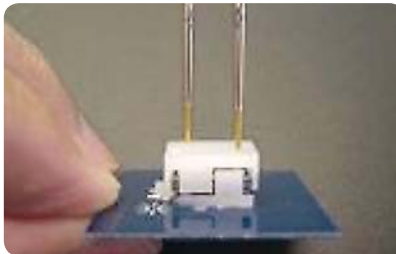
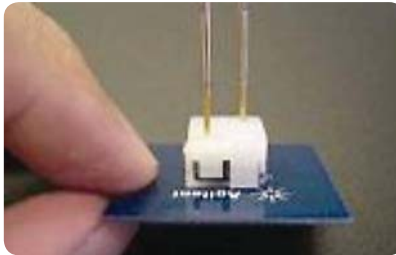
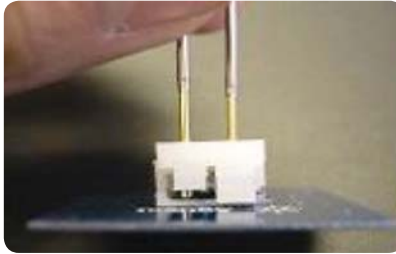

Figure 21. Final assembly

Table 2. Please reference the part numbers below should you need to order any of the parts quoted in this documentation.

Part Number	Description
N4302-48300	VTEP clip SP - for VTEP sensor plate
N4302-48301	VTEP clip AB - for VTEP amp board
N4302-90000	Part number of this shipped documentation

## Inside the Fixture

Below are some examples of how the VTEP clip is installed inside the VTEP demo board fixture.

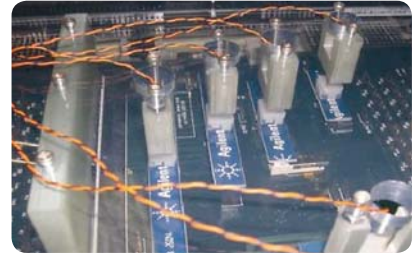

Figure 22. Example views inside the fixtures

# TestJet/VTEP Fixture Verifier

What's New in Revision 5.2 ..... 13  
 TestJet/VTEP Fixture Verifier Setup ..... 14  
 Set Up for Testing ..... 17  
 Test Procedure ..... 19

This section provides instructions for the setup and use of the TestJet/VTEP Fixture Verifier to validate TestJet and VTEP components after they are installed in Agilent ICT test fixtures.

## DISCLAIMER

Agilent Technologies, Inc does not bear any responsibility for the use of the TestJet/VTEP Fixture Verifier and its design. The performance of the Fixture Verifier and the interpretation of its reports and results are the responsibility of the user and not Agilent. The Fixture Verifier hardware components and design and the software are provided to the user as is and Agilent has no obligations to provide support for them.

## What's New in Revision 5.2

### Fixture Verifier Revision History

Fixture Verifier is primarily a tool to detect and verify the fixture connections between the AMP probes and the Mux card. The device has the capability of testing probe location and correct sensor plate position. Revision 5.1 had added two extra functions of Frequency and Voltage to verify the quality of the probes and the Mux card. Revision 5.1 had included some limited hardware additions and software upgrade. Revision 5.2 uses the same hardware and improves upon the reliability of the freq and voltage results.

The device is built from off-the shelf parts and controlled by software provided by Agilent. The software can be modified if needed for the user's specific needs.

### Fixture Verifier Revision 5.2

Fixture Verifier Revision 5.2 is a software upgrade to improve the reliability of the freq error and voltage error results. The hardware remains the same going from Revision 5.1 to 5.2. It is also highly recommended that for the best results with Revision 5.2, the cable connecting the Verifier to the mux card be of about four inches in length. As the length of the cable increases, the frequency results could become unstable and unreliable. However, it is important to note that one can still completely verify the probe type and sensor plate connections at longer cable lengths. The maximum cable length should not exceed 3.5 ft (about 1 m). If the fixture cannot be accessed with short cable length, it might be best to first test individual parts with a short cable setup and use the long cable to the fixture to ascertain if the wiring is correct.

The frequency and voltage error results are presented as shown in Figure 23

The frequency (freq) and voltage error results are in percentages off the ideal value. It is recommended that the Frequency and Voltage error does not go over 10%.

If the frequency error > 10% or NAD (Not able to Determine), then probe could be out of spec. Please ensure

that the cable length is of recommended length (4") and there is adequate grounding on the Verifier and the connections are secure.

A voltage result over 10% is a little bit more difficult to analyze. There are two possible causes for a bad voltage result; a bad probe or a bad mux card. If it is a bad mux card, most of the voltage measurements should be bad. Otherwise, chances are more likely that a bad probe caused the bad voltage measurement.

- **Probe out of spec:**
  - freq error > 10%
  - voltage error for most of the probes is < 10%
- **MUX out of spec:**
  - voltage error for most of the probes > 10%
  - can cause freq error > 10%
- **Both out of spec:**
  - almost all measurements are > 10%

Another feature that has changed in Revision 5.2 is that the timeout limit while checking for the sensor plates has been removed. During the manual hand-held sensor plate tests a timeout was used to test for the presence of the sensor plates. In Revision 5.2, the program will wait indefinitely for the correct plate to be identified with the provision of skipping the test by entering a character.

```

Mux cards found:
Address  Type
-----  -
  1      UTEP

Searching for probes and measuring frequency and
voltage (about 180 seconds each mux)...

mux : probe : probetype : freq error : voltage error
-----
  1 : 1 :          :           :
  1 : 2 :          :           :
  1 : 3 : UTEP     : 0.21%    : 1.02%
  1 : 4 :          :           :
  1 : 5 :          :           :
    
```

The Freq and Voltage error of revision 5.2

Figure 23 The Freq and voltage error results of revision 5.2

# TestJet/VTEP Fixture Verifier Setup

## Software Installation

1. Download the latest Fixture Verifier package Testjet\_VTEP\_FixtureVerifier\_Rev5.2.zip and unzip it.

The unzipped folder should contain the following files.

2. Copy the **vtepl.dll** utility library file from the Testjet\_VTEP\_FixtureVerifier\_Rev5.2 folder to **C:\Windows\system32**. This replaces the older utility library from Revision 5.1

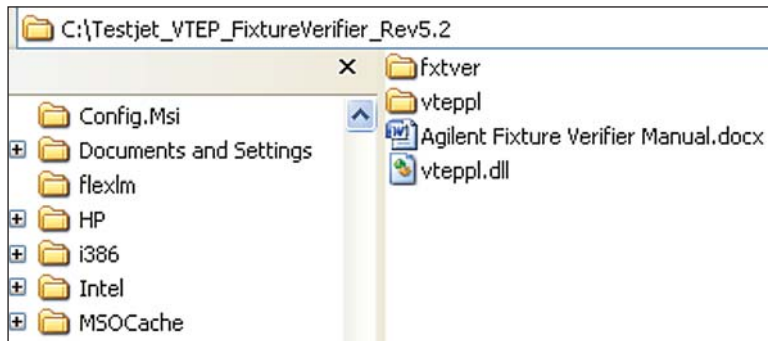

Figure 24. Verifier files

## Hardware Installation

### Build Fixture Verifier Circuit

The components required to build the Fixture Verifier are given in Table 3 and Table 4. Users upgrading to revision 5.1 or above will require the additional components in Table 4.

Table 3 Components required for verifier circuit revision 5.1

Verifier Circuit	Quantity	Manufacturer and Part #
7"x 5"x 3" Project Enclosure Box	1	RadioShack® #270-1807
Data Acquisition Module (Measurement Computing)	1	USB-1208LS
Test Probe Leads (for Hand-Held Probe)	1	RadioShack®
#278-704A Component PC Board	1	
20K ohm Resistor	1	
499 ohm Resistor	1	
N.O. Relay	2	Coto 9091-05-01 Alternative: Takamisawa RY5W-K
10 pin Ribbon Cable	1	MUX Card Cable
Various Sizes of 30 Gauge Wire Wrap	varies	

Table 4 Components required to upgrade verifier to revision 5.1

Frequency and Voltage Measurement Circuit (Rev 5.1)	Quantity	Manufacturer and Part Number
Quad 2-input AND gate	1	MC74ACT08N Quad
Differential Comparator	1	LM339N
0.01uF Capacitor	1	
5.11K Ohm Resistor	1	
51.1K Ohm Resistor	1	



Figure 25. Hardware components



Build the verifier circuit according to the schematic diagram in Figure 26. Users who are upgrading from revision 5.1 should refer to the additional assembly highlighted by the red box in Figure 26

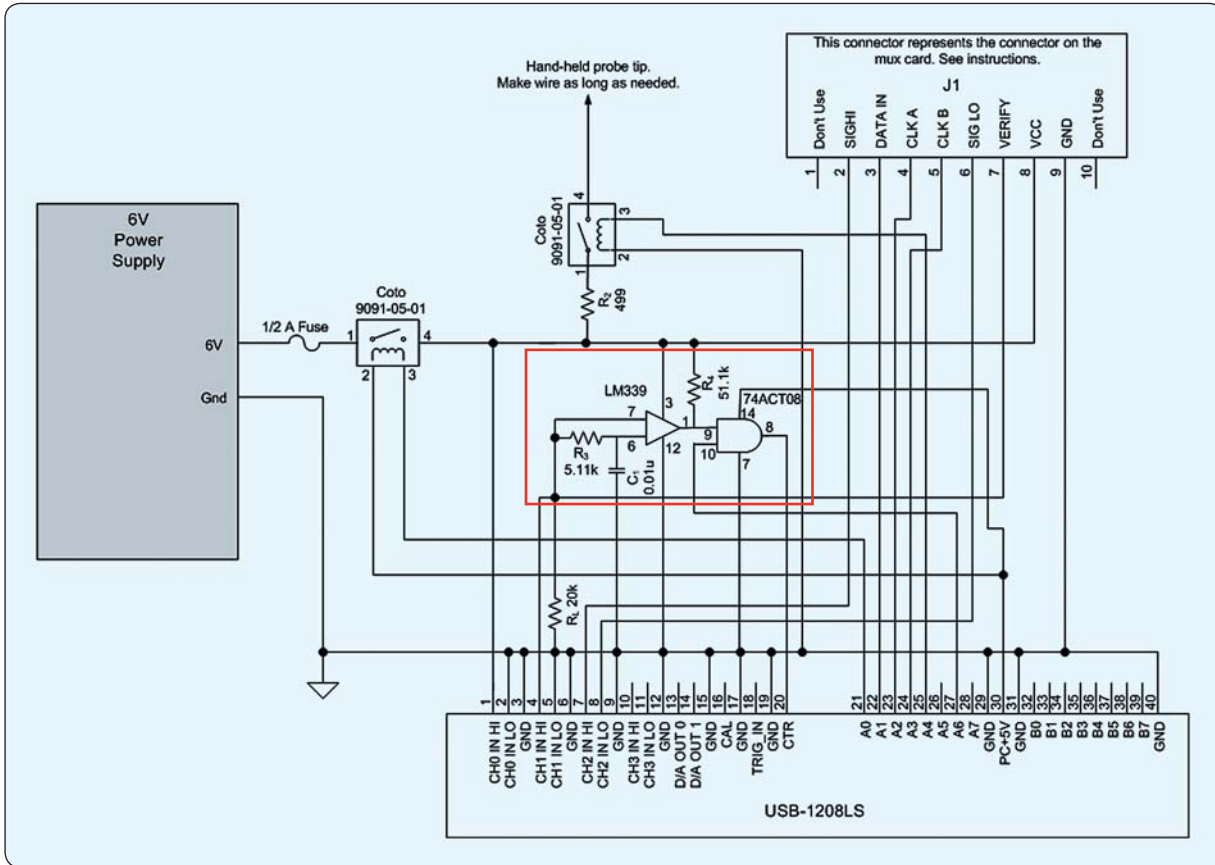

Figure 26. Fixture verifier circuitry (revision 5.2)

## Install Drivers

The Data Acquisition Module from Measurement Computing comes with a MCC DAQ CD. Install the InstaCal driver from this CD to your computer to enable communication between the computer and the USB module through the USB cable.

If InstaCal is installed in C:\ drive, an MCC folder will be created in the root directory. Open the MCC folder and copy the cbw32.dll utility library to C:\WINDOWS\system32.



Figure 27. Front and rear views of verifier after installation



# Set Up for Testing

**Set up the Fixture Verifier for testing as follows.**

- 1. Connect the cables.

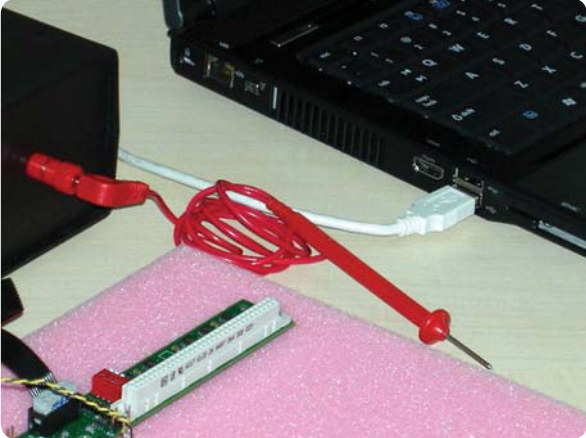

Figure 28. Connect power adaptor and USB cable to Fixture Verifier

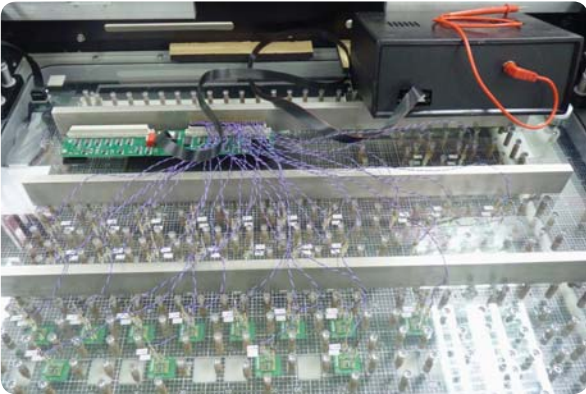

Figure 29. Shows the setup of the Verifier when testing the wiring of the VTEP Mux and VTEP probes on a fixture. Connect the USB cable to computer, and connect the test probe and flex cable.

2. Run InstaCal and select the USB board number. These steps must be done every time the USB cable is disconnected and reconnected to the computer.

a. Click Start > All Programs > Measurement Computing > InstaCal.

The software will detect the USB module connected to the computer. Click OK.

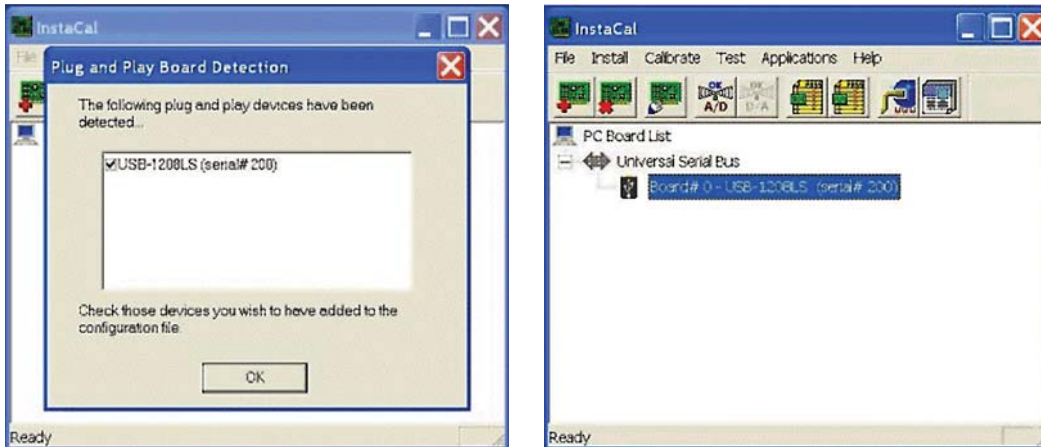

Figure 30. InstaCal windows

b. Right- click on Board# 0 and select Change Board#. From the pull-down menu, select 1 and click OK.

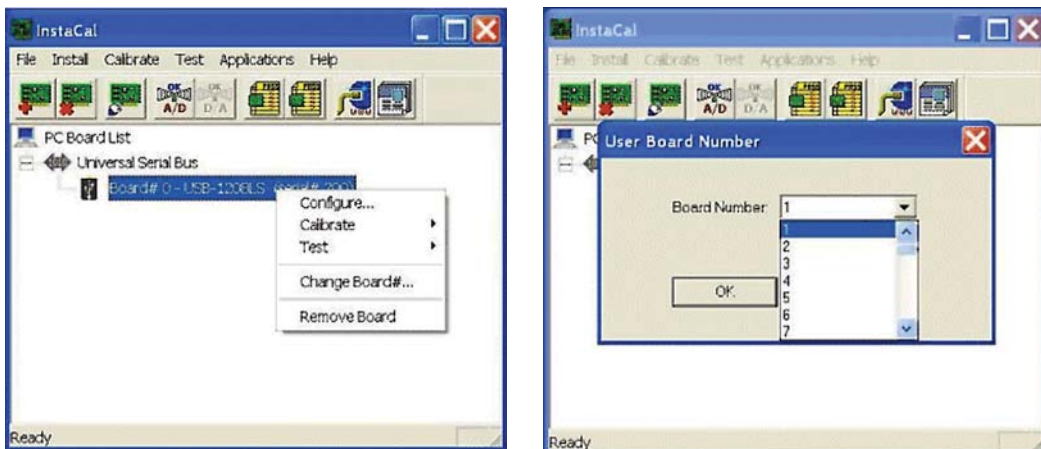

Figure 31. InstaCal windows

3. Turn on the power to the Fixture Verifier. The USB module is now configured to start the verifier test.

## Test Procedure

1. Insert the flex cable from the Fixture Verifier to the MUX card.

J1 connector on the Fixture Verifier must be configured 1-to-1 to the MUX card J1 connector. (Example: J1 pin 1 from the Fixture Verifier must be connected to J1 pin 1 on the MUX card through the flex cable and 10-pin female connector.)



Figure 32. Flex cable connection

2. Run fxtver.exe in the Testjet\_VTEP\_FixtureVerifier\_Rev5.1\fxtver\Debug folder.
3. Enter the fixture name and user name to proceed with the verification.

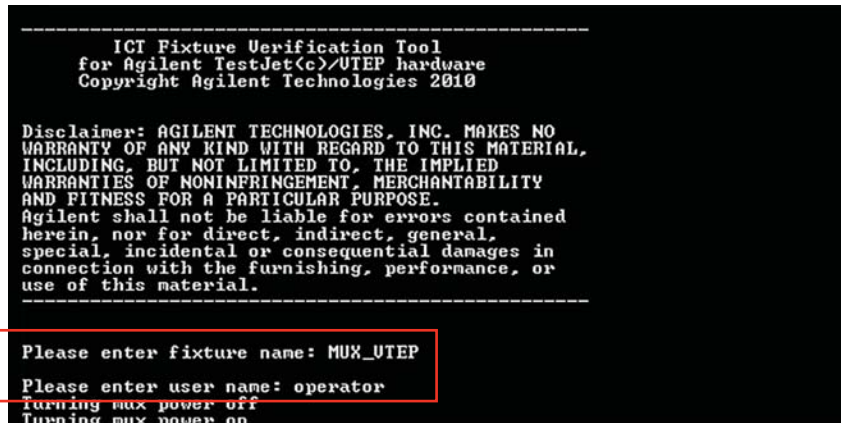

Figure 33. Enter fixture name and user name

The Fixture Verifier will do the following:

- Check the MUX card address and the MUX card type.
- Perform the AMP board verification for all 64 ports on the MUX card.

4. Follow the instructions on the screen to perform the sensor plate test for the ports that are present. Touch the test probe to the centre of each sensor plate (via).

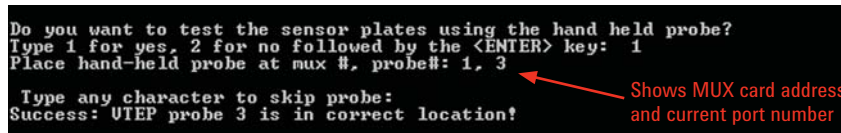
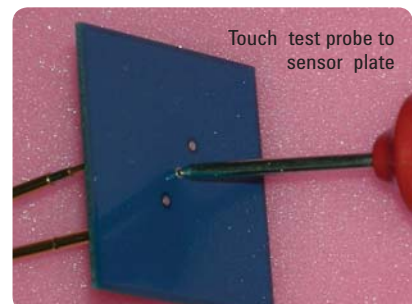

Figure 34. Sensor plate test



This completes the Fixture Verifier test.

# Installation Scenarios and Verifier Results

Verification of TestJet Hardware Installation ..... 20

Verification of VTEP Hardware Installation ..... 29

This chapter describes various incorrect installations of the TestJet and VTEP hardware, and shows how the TestJet/VTEP Fixture Verifier reports these errors.

## Verification of TestJet Hardware Installation

Table 5 lists several TestJet hardware installation scenarios and the results reported by the Fixture Verifier. Details are provided in the following pages.

Table 5. TestJet hardware installation scenarios and Fixture Verifier results

		Installation			Fixture Verifier Results	
MUX		AMP board		Sensor Plate	probetype	probe result
1	Correct	Port 1	Correct	Correct	PRESENT	SUCCESS
		Port 2	Correct	Correct	PRESENT	SUCCESS
2	Correct	Port 1	Correct	Correct	PRESENT	SUCCESS
		Port 2	Hanger probe on correct side but <b>reversed polarity</b> (signal hanger probe is in ground socket and vice versa)	Correct	BACKWARDS	Blank
3	Correct	Port 1	Hanger probes on <b>wrong side</b> Signal probe is in input socket for sensor plate	On wrong side of AMP board	Blank	Blank
		Port 2	Hanger probes on <b>wrong side</b> Signal probe is in ground socket for sensor plate	On wrong side of AMP board	BACKWARDS	Blank
4	Correct	Port 1	Correct	Correct	PRESENT	SUCCESS
		Port 2	Correct	<b>Reversed polarity</b>	PRESENT	NOT DETECTED
5	Correct	Port 1	Correct	Correct	PRESENT	SUCCESS
		Port 2	<b>VTEP AMP board</b> with correct hanger probe installation	On correct side and polarity of VTEP AMP board	PRESENT	NOT DETECTED
6	Correct	Port 1	Correct	Correct	PRESENT	SUCCESS
		Port 2	<b>VTEP AMP board</b> with hanger probes in reversed polarity	On correct side and polarity of VTEP AMP board	BACKWARDS	Blank
7	Correct	Port 1	Correct	Correct	PRESENT	SUCCESS
		Port 2	<b>VTEP AMP board</b> with hanger probes installed on <b>wrong side</b> . Signal hanger probe is in input socket for sensor plate; ground hanger probe is in ground socket for sensor plate.	On wrong side of VTEP AMP board Input pin is in signal socket	PRESENT	SUCCESS
8	Correct	Port 1	Correct	Correct	PRESENT	SUCCESS
		Port 2	<b>VTEP AMP board</b> with hanger probes installed on <b>wrong side</b> . Signal hanger probe is in ground socket for sensor plate; ground hanger probe is in signal socket for sensor plate.	On wrong side of VTEP AMP board Input pin is in ground socket	BACKWARDS	Blank

## Scenario 1: Correct Installation

### A. On Fixture Verifier console (Figure 35):

1. MUX card detected – displays MUX card address and type
2. Ports 1 to 64 on MUX card scanned for AMP board – results shown in probetype column
3. Sensor plate test performed only on ports with AMP probes detected – results show whether probes are correctly installed

```

Please enter user name: THANA
Turning mux power off
Turning mux power on
The power supply voltage is 6.10 volts.
Searching for mux cards (about 35 seconds)...

Mux cards found:
Address  Type
-----  -
  1      TestJet

Searching for probes and measuring frequency and
voltage(about 160 seconds each mux)...

: mux : probe : probetype : freq : voltage :
:     :       :          : error : error   :
-----:-----:-----:-----:-----:
:  1  :   1   : PRESENT  :       :         :
:  1  :   2   : PRESENT  :       :         :
:  1  :   3   :          :       :         :
:  1  :   4   :          :       :         :
:  1  :   5   :          :       :         :
  
```

1. MUX card detected (Address is 1, type is TestJet)

2. AMP probe test results (Probes present on ports 1 and 2)

```

Do you want to test the sensor plates using the hand held probe?
Type 1 for yes, 2 for no followed by the <ENTER> key: 1
Place hand-held probe at mux #, probe#: 1, 1

Type any character to skip probe:
Success: TestJet probe 1 is in correct location!

Place hand-held probe at mux #, probe#: 1, 2

Type any character to skip probe:
Success: TestJet probe 2 is in correct location!

Verification results can be seen in verify.txt file...
Turning mux power off

Type any character followed by the <ENTER> key to quit._
  
```

3. Sensor plate test

Test probe at MUX card address 1, port 1

Test result (correct installation)

Figure 35. Fixture verifier console

### B. In Verify.txt file (Figure 36):

```

Date : Mon May 26 18:28:13 2008
Fixture being verified : MUX_TESTJET_E3849-66501-3257-23-20C726-00005
User verifying fixture : THANA

: mux : probe : probetype : proba result :
:-----:-----:-----:-----:
:  1  :   1   : PRESENT  : SUCCESS      :
:  1  :   2   : PRESENT  : SUCCESS      :
:  1  :   3   :          :              :
:  1  :   4   :          :              :
:  1  :   5   :          :              :
  
```

Sensor plate test results

AMP board test results

Figure 36. Test report

## Scenario 2: Incorrect hanger probe connections on port 2

Installation			
MUX	AMP board		Sensor Plate
Correct	Port 1	Correct	Correct
	Port 2	Hanger probes on correct side but <b>reversed polarity</b> (Signal hanger probe is in Ground socket and vice versa)	Correct

### A. On Fixture Verifier console (Figure 37):

1. In the AMP probe test, the port 2 probes are detected as backwards.
2. The sensor plate test is performed on port 1 only.

```

Please enter user name: THANA
Turning mux power off
Turning mux power on
The power supply voltage is 6.10 volts.
Searching for mux cards (about 35 seconds)...

Mux cards found:
Address  Type
-----  -
      1  TestJet

Searching for probes and measuring frequency and
voltage(about 160 seconds each mux)...

: mux : probe : probetype : freq : voltage :
:     :       :           : error : error   :
-----:-----:-----:-----:-----:
:  1  :   1   : PRESENT  :      :         :
:  1  :   2   : BACKWARDS:      :         :
:  1  :   3   :          :      :         :
:  1  :   4   :          :      :         :
:  1  :   5   :          :      :         :
  
```

1. Port 1 probes on AMP board passed Port 2 probes detected as backwards

```

:  1  :   64  :          :      :         :
-----:-----:-----:-----:-----:

Do you want to test the sensor plates using the hand held probe?
Type 1 for yes, 2 for no followed by the <ENTER> key: 1
Place hand-held probe at mux #, probe#: 1, 1

Type any character to skip probe:
Success: TestJet probe 1 is in correct location!

Verification results can be seen in verify.txt file...
Turning mux power off
Type any character followed by the <ENTER> key to quit._
  
```

2. Sensor plate test done on port 1 only

Figure 37. Fixture verifier console

### B. In Verify .txt file (Figure 38):

```

Date : Mon May 26 19:03:27 2008
Fixture being verified : MUX_TESTJET_E3849-66501-325/-23-200/26-00005
User verifying fixture : THANA

: mux : probe : probetype : probe result :
-----:-----:-----:-----:
:  1  :   1   : PRESEN   : SUCCESS      :
:  1  :   2   : BACKWARDS:              :
:  1  :   3   :          :              :
:  1  :   4   :          :              :
:  1  :   5   :          :              :
  
```

**NOTE:** The Fixture Verifier shows similar results if the signal and ground connections are reversed on the MUX card.

Sensor plate test not done on port 2

Figure 38. Test report

## Scenario 3: Hanger probes on wrong side of AMP board

Installation			
MUX	AMP board		Sensor Plate
Correct	Port 1	Hanger probes on <b>wrong side</b> Signal probe is in Input socket for sensor plate	On wrong side of AMP board
	Port 2	Hanger probes on <b>wrong side</b> Signal probe is in Ground socket for sensor plate	On wrong side of AMP board

### A. On Fixture Verifier console (Figure 39):

1. Although the hanger probes installation on port 1 is incorrect, there is no failure message. You must know how many ports on the MUX card are in use, and verify all of them.
2. Sensor plate test is not performed due to failure on both ports.

```

Please enter user name: THANA
Turning mux power off
Turning mux power on
The power supply voltage is 6.13 volts.
Searching for mux cards (about 35 seconds)...

Mux cards found:
Address  Type
-----  -
1       TestJet

Searching for probes and measuring frequency and
voltage(about 160 seconds each mux)...
-----:
: mux : probe : probetype : freq : voltage :
:     :      :           : error : error   :
-----:
: 1 : 1 :           :      :         :
: 1 : 2 : BACKWARDS :      :         :
: 1 : 3 :           :      :         :
: 1 : 4 :           :      :         :
: 1 : 5 :           :      :         :

```

```

: 1 : 64 :
:-----:
Do you want to test the sensor plates using the hand held probe?
Type 1 for yes, 2 for no followed by the <ENTER> key: 1

Verification results can be seen in verify.txt file...
Turning mux power off

Type any character followed by the <ENTER> key to quit.

```

1. No results for port 1  
Port 2 connection detected as backwards
2. Sensor plate test not done

Figure 39. Fixture verifier console

### B. In Verify.txt file (Figure 40):

```

Date : Mon May 26 11:11:19 2008
Fixture being verified : MUX_TESTJET_E3849-66501-3257-23-200/26-00005
User verifying fixture : THANA

-----:
: mux : probe : probetype : probe result :
:     :      :           :              :
: 1 : 1 :           :              :
: 1 : 2 : BACKWARDS :              :
: 1 : 3 :           :              :
: 1 : 4 :           :              :
: 1 : 5 :           :              :

```

Figure 40. Test report

## Scenario 4: Port 2 sensor plate is reversed

Installation			
MUX	AMP board		Sensor Plate
Correct	Port 1	Correct	Correct
	Port 2	Correct	Reversed polarity

### A. On Fixture Verifier console (Figure 41):

1. Probe tests on AMP board passed
2. Sensor plate is not detected. After few unsuccessful attempts, you can choose to skip the test.

```

Please enter user name: THANA
Turning mux power off
Turning mux power on
The power supply voltage is 6.13 volts.
Searching for mux cards (about 35 seconds)...

Mux cards found:
Address  Type
-----  -
      1  TestJet

Searching for probes and measuring frequency and
voltage(about 160 seconds each mux)...
:-----:
: mux : probe : probetype : freq  : voltage :
:     :       :          : error : error   :
:-----:
:  1 :   1 : PRESENT  :       :         :
:  1 :   2 : PRESENT  :       :         :
:  1 :   3 :          :       :         :
:  1 :   4 :          :       :         :
:  1 :   5 :          :       :         :
:-----:
:  1 :   1 :          :       :         :
:  1 :   2 :          :       :         :
:  1 :   3 :          :       :         :
:  1 :   4 :          :       :         :
:  1 :   5 :          :       :         :
:-----:
:  1 :   1 :          :       :         :
:  1 :   2 :          :       :         :
:  1 :   3 :          :       :         :
:  1 :   4 :          :       :         :
:  1 :   5 :          :       :         :
:-----:
:  1 :   1 :          :       :         :
:  1 :   2 :          :       :         :
:  1 :   3 :          :       :         :
:  1 :   4 :          :       :         :
:  1 :   5 :          :       :         :
:-----:

Do you want to test the sensor plates using the hand held probe?
Type 1 for yes, 2 for no followed by the <ENTER> key: 1
Place hand-held probe at mux #, probe#: 1, 1

Type any character to skip probe:
Success: TestJet probe 1 is in correct location!

Place hand-held probe at mux #, probe#: 1, 2

Type any character to skip probe:

Verification results can be seen in verify.txt file...
Turning mux power off

Type any character followed by the <ENTER> key to quit.
  
```

Figure 41. Fixture verifier console

### B. In Verify.txt file (Figure 42):

```

Date : Mon Oct 25 14:04:59 2010
Fixture being verified : MUX_TESTJET
User verifying fixture : SS
:-----:
: mux : probe : probetype : probe result :
:-----:
:  1 :   1 : PRESENT  : SUCCESS      :
:  1 :   2 : PRESENT  : SKIPPED     :
:  1 :   3 :          :              :
:  1 :   4 :          :              :
:  1 :   5 :          :              :
:  1 :   6 :          :              :
:  1 :   7 :          :              :
:  1 :   8 :          :              :
:  1 :   9 :          :              :
:  1 :  10 :          :              :
:-----:
  
```

Figure 42. Test report



## Scenario 5: VTEP AMP board and sensor plate installed on port 2

Installation		
MUX	AMP board	Sensor Plate
Correct	Port 1 Correct	Correct
	Port 2 <b>VTEP AMP board</b> (incorrect type) with correct hanger probe installation	On correct side and polarity of VTEP AMP board

### A. On Fixture Verifier console (Figure 43):

1. Probe tests on AMP board passed
2. Sensor plate is not detected. After a few unsuccessful attempts, you can choose to skip the test.

```

Please enter user name: THANA
Turning mux power off
Turning mux power on
The power supply voltage is 6.12 volts.
Searching for mux cards (about 35 seconds)...

Mux cards found:
Address  Type
-----  -
1       TestJet

Searching for probes and measuring frequency and
voltage(about 160 seconds each mux)...
: mux : probe : probetype : freq : voltage
:     :     :          : error : error
-----
: 1 : 1 : PRESENT :      :
: 1 : 2 : PRESENT :      :
: 1 : 3 :          :      :
: 1 : 4 :          :      :
: 1 : 5 :          :      :
:   :   :          :      :

: 1 : 64 :          :      :
:   :   :          :      :

Do you want to test the sensor plates using the hand held probe?
Type 1 for yes, 2 for no followed by the <ENTER> key: 1
Place hand-held probe at mux #, probe#: 1, 1

Type any character to skip probe:
Success: TestJet probe 1 is in correct location!

Place hand-held probe at mux #, probe#: 1, 2

Type any character to skip probe:

Verification results can be seen in verify.txt file...
Turning mux power off

Type any character followed by the <ENTER> key to quit.
  
```

Figure 43 Fixture verifier console

### B. In Verify.txt file (Figure 44):

```

Date : Mon Oct 25 14:04:59 2010
Fixture being verified : MUX_TESTJET
User verifying fixture : SS

: mux : probe : probetype : probe result
-----
: 1 : 1 : PRESENT : SUCCESS
: 1 : 2 : PRESENT : SKIPPED
: 1 : 3 :          :
: 1 : 4 :          :
: 1 : 5 :          :
: 1 : 6 :          :
: 1 : 7 :          :
: 1 : 8 :          :
: 1 : 9 :          :
: 1 : 10 :          :
  
```

Figure 44. Test report

## Scenario 6: VTEP AMP board and sensor plate installed on port 2; hanger probes are reversed

Installation			
MUX	AMP board		Sensor Plate
Correct	Port 1	Correct	Correct
	Port 2	VTEP AMP board with hanger probes installed on correct side but in reversed polarity	On correct side and polarity of AMP board

### A. On Fixture Verifier console (Figure 45):

1. In the AMP probe test, the port 2 probes are detected as backwards.
2. The sensor plate test is performed on port 1 only.

```

Please enter user name: THANA
Turning mux power off
Turning mux power on
The power supply voltage is 6.04 volts.
Searching for mux cards (about 35 seconds)...

Mux cards found:
Address  Type
-----  -
1       TestJet

Searching for probes and measuring frequency and
voltage(about 160 seconds each mux)...

: mux : probe : probetype : freq : voltage :
:     :       :           : error : error   :
:-----:-----:-----:-----:-----:
: 1 : 1 : PRESENT  :      :        :
: 1 : 2 : BACKWARDS:      :        :
: 1 : 3 :          :      :        :
: 1 : 4 :          :      :        :
: 1 : 5 :          :      :        :

```

1. Port 2 probes detected as backwards

```

: 1 : 64 :
:-----:-----:
Do you want to test the sensor plates using the hand held probe?
Type 1 for yes, 2 for no followed by the <ENTER> key: 1
Place hand-held probe at mux #, probe#: 1, 1
Type any character to skip probe:
Success: TestJet probe 1 is in correct location!

Verification results can be seen in verify.txt file...
Turning mux power off
Type any character followed by the <ENTER> key to quit._

```

2. Sensor plate done on port 1 only

Figure 45. Fixture verifier console

### B. In Verify.txt file (Figure 46):

```

Date : Mon Jun 16 14:21:08 2008
Fixture being verified : MUX_TESTJET_E3849-66501-3257-23-200726-00005
User verifying fixture : THANA

: mux : probe : probetype : probe result :
:-----:-----:-----:-----:
: 1 : 1 : PRESENT  : SUCCESS      :
: 1 : 2 : BACKWARDS:               :
: 1 : 3 :          :               :
: 1 : 4 :          :               :
: 1 : > :          :               :

```

Sensor plate test not done on port 2

Figure 46. Test report

## Scenario 7: Port 2 has VTEP AMP board and sensor plate; hanger probes on wrong side of board

Note locations of hanger probes on port 2:

Installation			
MUX	AMP board		Sensor Plate
Correct	Port 1	Correct	Correct
	Port 2	VTEP AMP board with hanger probes installed on wrong side of the board Signal hanger probe is in Input socket for sensor plate; ground hanger probe is in Ground socket for sensor plate	On wrong side of AMP board Input pin is in Signal socket

### A. On Fixture Verifier console (Figure 47):

1. Probe tests on AMP board passed
2. Sensor plate test passed

The Fixture Verifier is unable to detect the incorrect installation in this case.

```

Please enter user name: THANA
Turning mux power off
Turning mux power on
The power supply voltage is 6.04 volts.
Searching for mux cards (about 35 seconds)...

Mux cards found:
Address  Type
-----  -
1       TestJet

Searching for probes and measuring frequency and
voltage(about 160 seconds each mux)...
-----
: mux : probe : probetype : freq : voltage :
:     :       :           : error : error   :
-----
: 1 : 1 : PRESENT :      :         :
: 1 : 2 : PRESENT :      :         :
: 1 : 3 :         :      :         :
: 1 : 4 :         :      :         :
: 1 : 5 :         :      :         :

```

```

Do you want to test the sensor plates using the hand held probe?
Type 1 for yes, 2 for no followed by the <ENTER> key: 1
Place hand-held probe at mux #, probe#: 1, 1

Type any character to skip probe:
Success: TestJet probe 1 is in correct location!

Place hand-held probe at mux #, probe#: 1, 2

Type any character to skip probe:
Success: TestJet probe 2 is in correct location!

Verification results can be seen in verify.txt file...
Turning mux power off

Type any character followed by the <ENTER> key to quit...

```

2. Sensor plate test pass

1. AMP probe tests passed

Figure 47. Fixture verifier console

### B. In Verify.txt file (Figure 48):

```

Date : Mon Jun 16 14:55:58 2008
Fixture being verified : MUX_TESTJET_E3849-66501-3257-23-200726-00005
User verifying fixture : THANA
-----
: mux : probe : probetype : probe result :
-----
: 1 : 1 : PRESENT : SUCCESS :
: 1 : 2 : PRESENT : SUCCESS :
: 1 : 3 :         :         :
: 1 : 4 :         :         :
: 1 : 5 :         :         :

```

No errors reported

Figure 48. Test report

## Scenario 8: VTEP AMP board and sensor plate installed on port 2; hanger probes on wrong side of board and reversed

Note locations of hanger probes on port 2:

Installation			
MUX	AMP board		Sensor Plate
Correct	Port 1	Correct	Correct
	Port 2	VTEP AMP board with hanger probes installed on <b>wrong side</b> of the board Signal hanger probe is in Ground socket for sensor plate; ground hanger probe is in Signal socket for sensor plate	On wrong side of the AMP board Input pin is in Ground socket

### A. On Fixture Verifier console (Figure 49):

1. In the AMP probe test, the port 2 probes are detected as backwards.
2. Sensor plate test is not performed on port 2.

```

Please enter user name: THANA
Turning mux power off
Turning mux power on
The power supply voltage is 6.12 volts.
Searching for mux cards (about 35 seconds)...

Mux cards found:
Address  Type
-----  -
1       TestJet

Searching for probes and measuring frequency and
voltage(about 160 seconds each mux)...

: mux : probe : probetype : freq : voltage :
:     :       :           : error : error   :
-----:-----:-----:-----:-----:
: 1 : 1 : PRESENT :      :        :
: 1 : 2 : BACKWARDS :      :        :
: 1 : 3 :          :      :        :
: 1 : 4 :          :      :        :
: 1 : 5 :          :      :        :
  
```

```

: 1 : 64 :          :      :        :
:-----:-----:-----:-----:-----:

Do you want to test the sensor plates using the hand held probe?
Type 1 for yes, 2 for no followed by the <ENTER> key: 1
Place hand-held probe at mux #, probe#: 1, 1

Type any character to skip probe:
Success: TestJet probe 1 is in correct location!

Verification results can be seen in verify.txt file...
Turning mux power off

Type any character followed by the <ENTER> key to quit._
  
```

1. Port 2 probes are detected as backwards

2. Sensor plate test done on port 1 only

Figure 49. Fixture verifier console

### B. In Verify.txt file (Figure 50):

```

Date : MON JUN 16 14:59:58 2008
Fixture being verified : MUX_TESTJET_E3849-66501-3257-23-200726-00005
User verifying fixture : THANA

: mux : probe : probetype : probe result :
:-----:-----:-----:-----:
: 1 : 1 : PRESENT : SUCCESS :
: 1 : 2 : BACKWARDS :          :
: 1 : 3 :          :          :
: 1 : 4 :          :          :
: 1 : 5 :          :          :
  
```

Sensor plate test not done on port 2

Figure 50. Test report

## Verification of VTEP Hardware Installation

Table 6 lists several VTEP hardware installation scenarios and the results reported by the Fixture Verifier. Details are provided in the following pages.

Table 6. VTEP hardware installation scenarios and Fixture Verifier results

		Installation			Fixture Verifier Results		
MUX		AMP Board	Sensor Plate	probetype	probe result	freq error	voltage error
1	Correct	Port 1 Correct	Correct	VTEP	SUCCESS	less than 10	less than 10
		Port 2 Correct	Correct	VTEP	SUCCESS	less than 10	less than 10
2	Correct	Port 1 Correct	Correct	VTEP	SUCCESS	less than 10	less than 10
		Port 2 Hanger probe on correct side but <b>reversed polarity</b> . (Signal hanger probe is in ground socket and vice versa)	Correct	BACKWARDS	blank	blank	blank
3	Correct	Port 1 Hanger probe on <b>wrong side</b> of AMP board, Signal probe is in input socket for sensor plate.	On <b>wrong side</b> of AMP board	TESTJET	less than 10	blank	more than 10
		Port 2 Hanger probe on <b>wrong side</b> of AMP board, Signal probe is in ground socket for sensor plate.	On <b>wrong side</b> of AMP board	BACKWARDS	blank	blank	blank
4	Correct	Port 1 Correct	Correct	VTEP	SUCCESS	less than 10	less than 10
		Port 2 Correct	<b>Reversed polarity</b>	VTEP	NOT DETECTED	less than 10	less than 10
5	Correct	Port 1 Correct	Correct	VTEP	SUCCESS	less than 10	less than 10
		Port 2 <b>TestJet AMP board</b> (incorrect type) with correct hanger probe installation for TestJet	On correct side and polarity of <b>TestJet AMP board</b>	TESTJET	blank	more than 10	less than 10
6	Correct	Port 1 Correct	Correct	VTEP	SUCCESS	less than 10	less than 10
		Port 2 <b>TestJet AMP board</b> with hanger probes on correct side but reversed polarity	On correct side and polarity of AMP board	BACKWARDS	blank	blank	blank
7	Correct	Port 1 Correct	Correct	VTEP	SUCCESS	less than 10	less than 10
		Port 2 <b>TestJet AMP board</b> with hanger probe on <b>wrong side</b> . Signal hanger probe is in signal socket for sensor plate; ground probe is in ground socket.	On wrong side of AMP board. input pin is in Signal socket	TESTJET	blank	more than 10	less than 10
8	Correct	Port 1 Correct	Correct	VTEP	SUCCESS	less than 10	less than 10
		Port 2 <b>TestJet AMP board</b> with hanger probes on <b>wrong side</b> . Signal hanger probe is in ground socket for sensor plate; ground robe is in signal socket.	On wrong side of AMP board. Input pin is in Ground socket.	BACKWARDS	blank	blank	blank

## Scenario 1: Correct Installation

### A. On Fixture Verifier console (Figure 51):

1. MUX card detected – displays MUX card address and type
2. Ports 1 to 64 on MUX card scanned for AMP board – results shown in probetype column  
For VTEP, the values for freq error and voltage error must be less than 10.
3. Sensor plate test performed only on ports with AMP probes detected – results show whether probes are correctly installed

Turning mux power off  
Turning mux power on  
The power supply voltage is 6.14 volts.  
Searching for mux cards (about 35 seconds each mux card)...

Mux cards found:  
Address Type  
-----  
1 VTEP

Searching for probes and measuring frequency and voltage (about 180 seconds each mux)...

mux	probe	probetype	freq error	voltage error
1	1	VTEP	0.27%	0.69%
1	2	VTEP	0.38%	0.83%
1	3			
1	4			
1	5			
1	6			

Do you want to test the sensor plates using the hand held probe?  
Type 1 for yes, 2 for no followed by the <ENTER> key: 1  
Place hand-held probe at mux #, probe#: 1, 1  
Type any character to skip probe:  
Success: UTEP probe 1 is in correct location!  
Place hand-held probe at mux #, probe#: 1, 2  
Type any character to skip probe:  
Success: UTEP probe 2 is in correct location!

Verification results can be seen in verify.txt file...  
Turning mux power off  
Type any character followed by the <ENTER> key to quit.

1. MUX card detected (Address is 1, type is VTEP)

2. VTEP AMP board/probes detected

(Probes present on ports 1 and 2)

Values must be < 10

3. Sensor plate test

Test probe at MUX card address 1, port 1

Test result (correct installation)

Figure 51. Fixture verifier console

### B. In Verify.txt file (Figure 52):

Date : Tue May 27 16:02:46 2008  
Fixture being verified : MLX\_VTEP\_N4300-66533-4331-23-200718-00040  
User verifying fixture : THANA

mux	probe	probetype	probe result
1	1	VTEP	SUCCESS
1	2	VTEP	SUCCESS
1	3		
1	4		
1	5		

Sensor plate test results

AMP board test results

Figure 52. Test report

## Scenario 2: Incorrect hanger probe connections on port 2

Installation			
MUX	AMP board		Sensor Plate
Correct	Port 1	Correct	Correct
	Port 2	Hanger probes on correct side but <b>reversed polarity</b> (Signal hanger probe is in Ground socket and vice versa)	Correct

### A. On Fixture Verifier console (Figure 53):

1. In the AMP probe test, the port 2 probes are detected as backwards.
2. The sensor plate test is performed on port 1 only.

```

Turning mux power off
Turning mux power on
The power supply voltage is 6.14 volts.
Searching for mux cards (about 35 seconds each mux card)...

Mux cards found:
Address      Type
-----
1           UTEP

Searching for probes and measuring frequency and
voltage(about 180 seconds each mux)...
: mux : probe : probetype : freq : voltage :
:      :       :           : error : error   :
:-----:-----:-----:-----:-----:
: 1 : 1 : UTEP : 0.25% : 2.03% :
: 1 : 2 : BACKWARDS : : :
: 1 : 3 : : : :
: 1 : 4 : : : :
: 1 : 5 : : : :
: 1 : 6 : : : :
  
```

1. Port 1 probes on AMP board passed  
Port 2 probes detected as backwards

```

: 1 : 64 : : : :
:-----:-----:-----:-----:-----:

Do you want to test the sensor plates using the hand held probe?
Type 1 for yes, 2 for no followed by the <ENTER> key: 1
Place hand-held probe at mux #, probe#: 1, 1

Type any character to skip probe:
Success: UTEP probe 1 is in correct location!

Verification results can be seen in verify.txt file...
Turning mux power off

Type any character followed by the <ENTER> key to quit.
  
```

2. Sensor plate test done on port 1 only

Figure 53. Fixture verifier console

### B. In Verify.txt file (Figure 54):

```

Date : Tue May 27 16:27:52 2008
Fixture being verified : MUX_VTEP_N4300-66533-4331-23-200718-00040
User verifying fixture : THANA

: mux : probe : probetype : probe result :
:-----:-----:-----:-----:
: 1 : 1 : VTEP : SUCCESS :
: 1 : 2 : BACKWARDS : :
: 1 : 3 : : :
: 1 : 4 : : :
: 1 : 5 : : :
  
```

**NOTE:** The Fixture Verifier shows similar results if the signal and ground connections are reversed on the MUX card.

Sensor plate test not done on port 2

Figure 54. Test report

## Scenario 3: Hanger probes on wrong side of AMP board

Installation			
MUX		AMP board	Sensor Plate
Correct	Port 1	Hanger probes on <b>wrong side</b> of AMP board, Signal probe is in Input socket for sensor plate.	On wrong side of AMP board
	Port 2	Hanger probes on <b>wrong side</b> of AMP board. Signal probe is in Ground socket for sensor plate.	On wrong side of AMP board

### A. On Fixture Verifier console (Figure 55):

1. The installations on ports 1 and 2 give different results. Note the high freq error for port 1. At times you might also see >10% or even NAD (Not Able to Determine).
2. Sensor plate test is not performed due to failure on both ports.

```

Turning mux power on
The power supply voltage is 6.14 volts.
Searching for mux cards (about 35 seconds each mux)...

Mux cards found:
Address  Type
-----  -
1       UTEP

Searching for probes and measuring frequency and
voltage(about 180 seconds each mux)...
: mux : probe : probetype : freq : voltage :
: : : : error : error :
: 1 : 1 : TESTJET : 9.50% : 0.15% :
: 1 : 2 : BACKWARDS : : :
: 1 : 3 : : : :
: 1 : 4 : : : :
: 1 : 5 : : : :
: 1 : 6 : : : :
: 1 : 7 : : : :
: 1 : 8 : : : :
: 1 : 9 : : : :
: 1 : 10 : : : :

: 1 : 64 : : : :
-----

Do you want to test the sensor plates using the hand held probe?
Type 1 for yea, 2 for no followed by the <ENTER> key: 1

Verification results can be seen in verify.txt file...
Turning mux power off

Type any character followed by the <ENTER> key to quit.
  
```

Figure 55. Fixture verifier console

### B. In Verify.txt file (Figure 56):

```

Date : Tue May 27 16:41:03 2008
Fixure being verified : MUX_VTEP_N4300-66533-4331-23-200718-00040
User verifying fixture : THANA

: mux : probe : prcbetype : probe result :
: 1 : 1 : TESTJET : :
: 1 : 2 : BACKWARDS : :
: 1 : 3 : : :
: 1 : 4 : : :
: 1 : 5 : : :
  
```

Figure 56. Test report



## Scenario 4: Port 2 sensor plate is reversed

Installation			
MUX	AMP board		Sensor Plate
Correct	Port 1	Correct	Correct
	Port 2	Correct	Reversed polarity

### A. On Fixture Verifier console (Figure 57):

- Probe tests on AMP board passed
- Sensor plate is not detected. After a few unsuccessful attempts, you can choose to skip the test.

```
Turning mux power off
Turning mux power on
The power supply voltage is 6.14 volts.
Searching for mux cards (about 35 seconds each mux card)...

Mux cards found:
Address  Type
-----  -
1       UTEP

Searching for probes and measuring frequency and
voltage(about 180 seconds each mux)...
: mux : probe : probetype : freq : voltage :
: error : error :
:-----:-----:-----:-----:-----:
: 1 : 1 : UTEP : 0.61% : 0.35% :
: 1 : 2 : UTEP : 1.38% : 0.99% :
: 1 : 3 :      :      :      :
: 1 : 4 :      :      :      :
: 1 : 5 :      :      :      :
: 1 : 6 :      :      :      :
```

1. AMP probe tests passed

```
: 1 : 64 :
:-----:-----:-----:-----:
Do you want to test the sensor plates using the hand held probe?
Type 1 for yes, 2 for no followed by the <ENTER> key: 1
Place hand-held probe at mux #, probe#: 1, 1

Type any character to skip probe:
Success: UTEP probe 1 is in correct location!

Place hand-held probe at mux #, probe#: 1, 2

Type any character to skip probe:

Verification results can be seen in verify.txt file...
Turning mux power off

Type any character followed by the <ENTER> key to quit.
```

Figure 57. Fixture verifier console

### B. In Verify.txt file (Figure 58):

```
Date : Mon Oct 25 17:13:05 2010
Fixture being verified : MUX_VTEP
user verifying fixture : ss

:-----:-----:-----:-----:
: mux : probe : probetype : probe result :
:-----:-----:-----:-----:
: 1 : 1 : VTEP : SUCCESS :
: 1 : 2 : VTEP : SKIPPED :
: 1 : 3 :      :          :
: 1 : 4 :      :          :
: 1 : 5 :      :          :
: 1 : 6 :      :          :
: 1 : 7 :      :          :
: 1 : 8 :      :          :
```

Sensor plate 2 not detected

Figure 58. Test report

## Scenario 5: Port 2 has TestJet AMP board and sensor plate

Installation			
MUX	AMP board		Sensor Plate
Correct	Port 1	Correct	Correct
	Port 2	TestJet AMP board (incorrect type) with correct hanger probe installation for TestJet	On correct side and polarity of TestJet AMP board

### A. On Fixture Verifier console (Figure 59):

1. Probe tests on port 2 failed. TestJet AMP board is detected with high frequency error.
2. Sensor plate is performed only for port 1.

```

Turning mux power off
Turning mux power on
The power supply voltage is 6.14 volts.
Searching for mux cards (about 35 seconds each mux card)...

Mux cards found:
Address  Type
-----  -
1        UTEP

Searching for probes and measuring frequency and
voltage (about 180 seconds each mux)...

: mux : probe : probetype : freq : voltage :
:     :       :           : error: error   :
: 1   : 1     : UTEP     : 0.17% : 0.49%   :
: 1   : 2     : TESTJET  : >10%  : 0.15%   :
: 1   : 3     :           :       :         :
: 1   : 4     :           :       :         :
: 1   : 5     :           :       :         :
: 1   : 6     :           :       :         :

: 1 : b4 : : : :
: : : : : : :

Do you want to test the sensor plates using the hand held probe?
Type 1 for yes, 2 for no followed by the <ENTER> key: 1
Place hand-held probe at mux #, probe#: 1, 1
Type any character to skip probe:
Success: UTEP probe 1 is in correct location!

Verification results can be seen in verify.txt file...
Turning mux power off
Type any character followed by the <ENTER> key to quit.

```

Figure 59. Fixture verifier console

### B. In Verify.txt file (Figure 60):

```

Date : Thu Jun 19 17:22:06 2008
Fixture being verified : MUX_VTEP_N4300-66533-4331-23-200718-00040
User verifying fixture : THANA

: mux : probe : probetype : probe result :
: 1   : 1     : UTEP     : SUCCESS      :
: 1   : 2     : TESTJET  :              :
: 1   : 3     :           :              :
: 1   : 4     :           :              :
: 1   : 5     :           :              :

```

Figure 60. Test report

## Scenario 6: Port 2 has VTEP AMP board and sensor plate; hanger probes are reversed

Installation			
MUX		AMP board	Sensor Plate
Correct	Port 1	Correct	Correct
	Port 2	TestJet AMP board with hanger probes on correct side but reversed polarity	On correct side and polarity of AMP board

### A. On Fixture Verifier console (Figure 61):

1. In the AMP probe test, the port 2 probes are detected as backwards.
2. The sensor plate test is performed on port 1 only.

```

Turning mux power off
Turning mux power on
The power supply voltage is 6.14 volts.
Searching for mux cards (about 35 seconds each mux card)...
Mux cards found:
Address      Type
-----
1           UTEP

Searching for probes and measuring frequency and
voltage (about 180 seconds each mux)...
: mux : probe : probetype : freq : voltage :
:      :       :           : error: error  :
: 1 : 1 : UTEP : 0.25% : 2.03% :
: 1 : 2 : BACKWARDS :
: 1 : 3 :
: 1 : 4 :
: 1 : 5 :
: 1 : 6 :

: 1 : 64 :
:-----:

Do you want to test the sensor plates using the hand held probe?
Type 1 for yes, 2 for no followed by the <ENTER> key: 1
Place hand-held probe at mux #, probe#: 1, 1
Type any character to skip probe:
Success: UTEP probe 1 is in correct location!

Verification results can be seen in verify.txt file...
Turning mux power off
Type any character followed by the <ENTER> key to quit.
  
```

1. Port 2 probes detected as backwards

2. Sensor plate done on port 1 only

Figure 61. Fixture verifier console

### B. In Verify.txt file (Figure 62):

```

date : Thu Jun 19 17:27:52 2008
Fixture being verified : MLX_VTEP_N4300-66533-4331-23-200718-00040
User verifying fixture : THANA

: mux : probe : probetype : probe result :
:-----:-----:
: 1 : 1 : UTEP : SUCCESS :
: 1 : 2 : BACKWARDS :
: 1 : 3 :
: 1 : 4 :
: 1 : 5 :
  
```

Sensor plate test not done on port 2

Figure 62. Test report

## Scenario 7: TestJet AMP board and sensor plate installed on port 2; hanger probes on wrong side of board

Note locations of hanger probes on port 2 in this scenario:

Installation			
MUX	AMP board		Sensor Plate
Correct	Port 1	Correct	Correct
	Port 2	TestJet AMP board with hanger probes on <b>wrong side</b> of the board. Signal hanger probe is in Signal socket for sensor plate; ground hanger probe is in Ground socket for sensor plate.	On wrong side of AMP board Input pin is in Signal socket

### A. On Fixture Verifier console (Figure 63):

1. Probe tests on port 2 failed. TestJet AMP board is detected with high frequency error.
2. The sensor plate test is performed on port 1 only.

```

Turning mux power off
Turning mux power on
The power supply voltage is 6.14 volts.
Searching for mux cards (about 35 seconds each mux)...

Mux cards found:
address  type
-----  -
1       UTEP

Searching for probes and measuring frequency and
voltage(about 180 seconds each mux)...
: mux : probe : probetype : freq : voltage :
:     :       :           : error : error   :
: 1 : 1 : UTEP : 0.17% : 0.49% :
: 1 : 2 : TESTJET : >10% : 0.15% :
: 1 : 3 :       :       :       :
: 1 : 4 :       :       :       :
: 1 : 5 :       :       :       :
: 1 : 6 :       :       :       :

```

1. TestJet detected on port 2 freq error is high

```

: 1 : 64 :
:-----:
Do you want to test the sensor plates using the hand held probe?
Type 1 for yes, 2 for no followed by the <ENTER> key: 1
Place hand-held probe at mux #, probe#: 1, 1

Type any character to skip probe:
Success: UTEP probe 1 is in correct location!

Verification results can be seen in verify.txt file...
Turning mux power off
Type any character followed by the <ENTER> key to quit.

```

2. Sensor plate test done on port 1 only

Figure 63. Fixture verifier console

### B. In Verify.txt file (Figure 64):

```

Date : Thu Jun 19 17:33:56 2008
Fixture being verified : MUX_VTEP_N4300-66533-4331-23-200718-00040
User verifying fixture : THANA

: mux : probe : prcbetype : probe result
:-----:
: 1 : 1 : VTEP : SUCCESS
: 1 : 2 : TESTJET :
: 1 : 3 :
: 1 : 4 :
: 1 : 5 :

```

No errors reported

Figure 64. Test report

## Scenario 8: TestJet AMP board and sensor plate installed on port 2; hanger probes on wrong side of board and reversed

Note locations of hanger probes on port 2 in this scenario:

Installation			
MUX	AMP board		Sensor Plate
Correct	Port 1	Correct	Correct
	Port 2	TestJet AMP board with hanger probes on <b>wrong side</b> of the board. Signal hanger probe is in Ground socket for sensor plate; ground hanger robe is in Signal socket for sensor plate	On wrong side of AMP board. Input pin is in Ground socket.

### A. On Fixture Verifier console (Figure 65):

1. In the AMP probe test, the port 2 probes are detected as backwards.
2. Sensor plate test is not performed on port 2.

```

Turning mux power off
Turning mux power on
The power supply voltage is 6.14 volts.
Searching for mux cards (about 35 seconds each mux card)...

Mux cards found:
Address      Type
-----
1           UTEP

Searching for probes and measuring frequency and
voltage (about 180 seconds each mux)...
: mux : probe : probetype : freq : voltage :
: : : : : error : error :
: 1 : 1 : UTEP : 0.25% : 2.03% :
: 1 : 2 : BACKWARDS : : :
: 1 : 3 : : : :
: 1 : 4 : : : :
: 1 : 5 : : : :
: 1 : 6 : : : :

: 1 : 64 : : : :
: : : : : :

Do you want to test the sensor plates using the hand held probe?
Type 1 for yes, 2 for no followed by the <ENTER> key: 1
Place hand-held probe at mux #, probe#: 1, 1

Type any character to skip probe:
Success: UTEP probe 1 is in correct location!

Verification results can be seen in verify.txt file...
Turning mux power off

Type any character followed by the <ENTER> key to quit.
  
```

1. Port 2 probes are detected as backwards

on port 1 only

Figure 65. Fixture verifier console

### B. In Verify.txt file (Figure 66):

```

Date : Thu Jun 19 17:38:46 2008
Fixture being verified : MUX_VTEP_N4300-66533-4331-23-200718-00040
User verifying fixture : THANA

: mux : probe : probetype : probe result :
: 1 : 1 : UTEP : SUCCESS :
: 1 : 2 : BACKWARDS : :
: 1 : 3 : : :
: 1 : 4 : : :
: 1 : 5 : : :
  
```

Sensor plate test not done on port 2

Figure 66. Test report



### Agilent Email Updates

[www.agilent.com/find/emailupdates](http://www.agilent.com/find/emailupdates)

Get the latest information on the products and applications you select.



[www.axistandard.org](http://www.axistandard.org)

AdvancedTCA® Extensions for Instrumentation and Test (AXIe) is an open standard that extends the AdvancedTCA® for general purpose and semiconductor test. Agilent is a founding member of the AXIe consortium.



[www.lxistandard.org](http://www.lxistandard.org)

LAN eXtensions for Instruments puts the power of Ethernet and the Web inside your test systems. Agilent is a founding member of the LXI consortium.



<http://www.pxisa.org>

PCI eXtensions for Instrumentation (PXI) modular instrumentation delivers a rugged, PC-based high-performance measurement and automation system.

### Agilent Channel Partners

[www.agilent.com/find/channelpartners](http://www.agilent.com/find/channelpartners)

Get the best of both worlds: Agilent's measurement expertise and product breadth, combined with channel partner convenience.



Agilent Advantage Services is committed to your success throughout your equipment's lifetime. We share measurement and service expertise to help you create the products that change our world. To keep you competitive, we continually invest in tools and processes that speed up calibration and repair, reduce your cost of ownership, and move us ahead of your development curve.

[www.agilent.com/find/advantageservices](http://www.agilent.com/find/advantageservices)



[www.agilent.com/quality](http://www.agilent.com/quality)

[www.agilent.com](http://www.agilent.com)

[www.agilent.com/find/limitedaccess](http://www.agilent.com/find/limitedaccess)

For more information on Agilent Technologies' products, applications or services, please contact your local Agilent office. The complete list is available at:

[www.agilent.com/find/contactus](http://www.agilent.com/find/contactus)

#### Americas

Canada	(877) 894 4414
Brazil	(11) 4197 3500
Mexico	01800 5064 800
United States	(800) 829 4444

#### Asia Pacific

Australia	1 800 629 485
China	800 810 0189
Hong Kong	800 938 693
India	1 800 112 929
Japan	0120 (421) 345
Korea	080 769 0800
Malaysia	1 800 888 848
Singapore	1 800 375 8100
Taiwan	0800 047 866
Other AP Countries	(65) 375 8100

#### Europe & Middle East

Belgium	32 (0) 2 404 93 40
Denmark	45 70 13 15 15
Finland	358 (0) 10 855 2100
France	0825 010 700*
	*0.125 €/minute
Germany	49 (0) 7031 464 6333
Ireland	1890 924 204
Israel	972-3-9288-504/544
Italy	39 02 92 60 8484
Netherlands	31 (0) 20 547 2111
Spain	34 (91) 631 3300
Sweden	0200-88 22 55
United Kingdom	44 (0) 118 9276201

For other unlisted Countries:

[www.agilent.com/find/contactus](http://www.agilent.com/find/contactus)

Revised: October 14, 2010

Product specifications and descriptions in this document subject to change without notice.

© Agilent Technologies, Inc. 2010  
Printed in USA, December 22, 2010  
5989-9375EN



**Agilent Technologies**