

Mobile WiMAX™ PHY Layer (RF) Operation and Measurement

Application Note

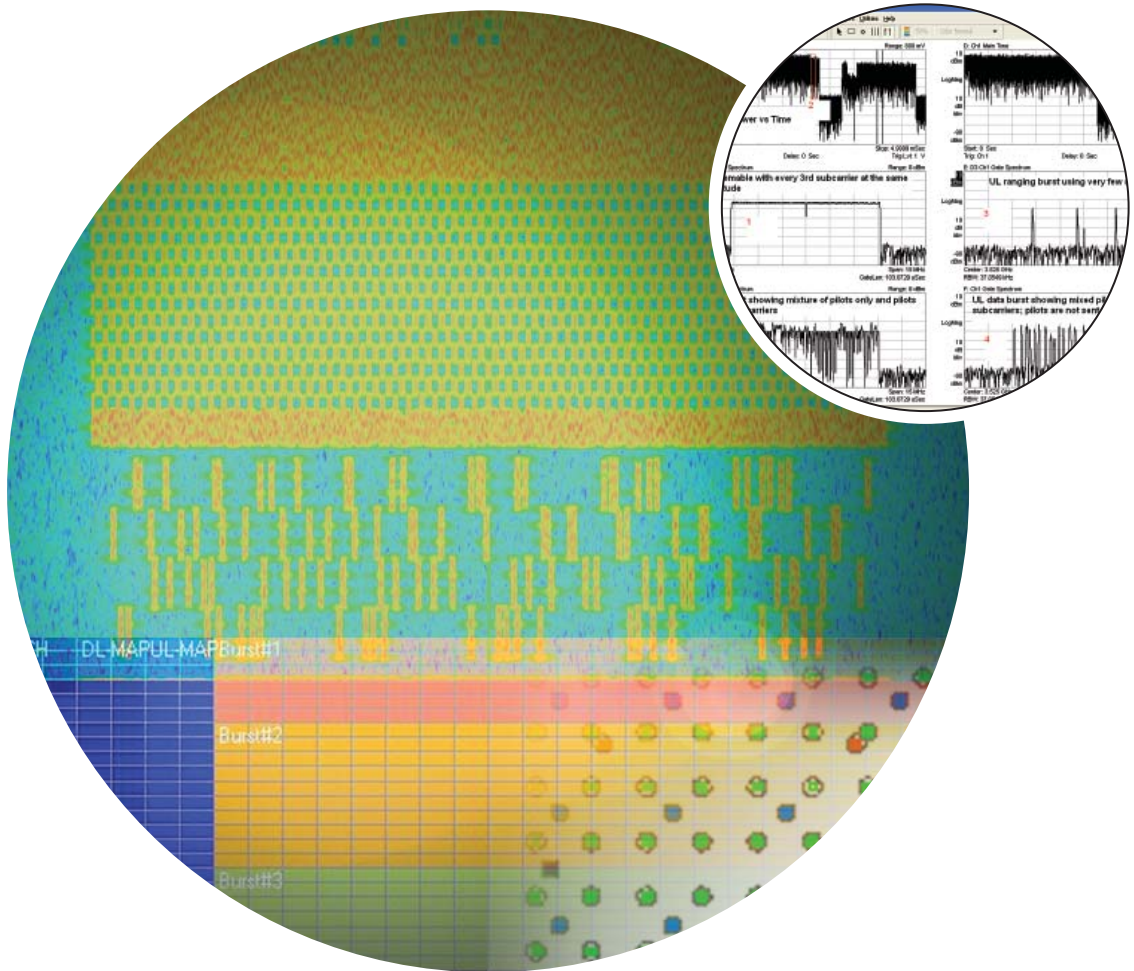
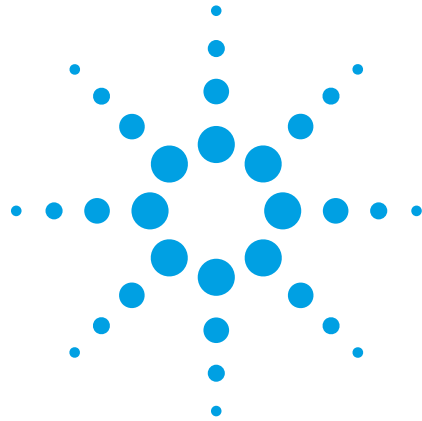

Introduction

This application note is intended for engineers developing and testing mobile or subscriber stations (MS or SS) and their components, based on the IEEE 802.16e orthogonal frequency division multiple access (OFDMA) amendment to the 802.16-2004 standard. These devices are intended for the Mobile WiMAX market.

Adding user mobility features to the conventional orthogonal frequency division multiplexing (OFDM) signal used in 802.16d for Fixed WiMAX™, introduces substantially more flexibility in the way that the radio signals are constructed. Mobility features give the network operator the freedom to adapt the operation of the base station (BS) to specific requirements of the physical location. It also introduces many variables that need to be understood and tested at several levels—from basic parametric tests, to end-to-end performance evaluation.

The first section of this application note describes OFDMA signals and the mechanisms used to make a connection between the BS and mobile station (MS). It also includes a description of the BS and MS, as well as information to understand transmitter and receiver tests. Finally, the section includes the basic information needed to understand initial WiMAX™ profiles.

The second section of this application note describes the layout and operation of the MS/SS. These will take a number of physical formats, starting as modules and then becoming embedded within the host device as vendor interoperability improves and areas of uncertainty in the specifications are removed. This section also highlights the software and hardware needed for testing.

Physical layer (PHY) test descriptions are focused around the RF connection and start with the transmitter tests in section four. This is the logical point to start in most test regimes. The tests are described in some detail to allow the reader to appreciate both how the signal is constructed, as well as what methods should be adopted for repeatable testing. The test descriptions continue with the main receiver test parameters, including a discussion of the use of arbitrary waveform fading and multiple input multiple output (MIMO) signal analysis. Some of the WIMAX Forum® receiver conformance tests are highly complex. The descriptions provided here are intended to act as an introduction.

Current consumption in any mobile device is a major concern. The final section of the application note explains the tools available to make current consumptions analysis simple and informative. These tools, for example, can help ensure that current drain drops as required in sleep and idle modes.

The market for this new OFDMA technology is still evolving. The specification itself is being enhanced in IEEE 802.16 Rev 2. It provides many options for the network operator when designing their systems. This application note is intended to help you understand all the major features of the physical layer relating to the MS and SS, and how to test them.

Table of Contents

| | |
|---|----|
| 1. Basic Concepts and Applications..... | 4 |
| 1.1 WiMAX and the IEEE 802.16 standard..... | 4 |
| 1.2 WiMAX Forum waves and profiles | 5 |
| 1.3 Mobile WiMAX and WiBRO..... | 5 |
| 1.4 Mobile WiMAX PHY..... | 5 |
| 1.5 Control mechanisms..... | 12 |
| 1.6 Media access control (MAC) layer..... | 12 |
| 2. Description of the Mobile Station (MS)..... | 15 |
| 3. PHY Layer (RF) Test Suite..... | 17 |
| 4. Transmitter Measurements..... | 18 |
| 4.1 Test conditions and measurement setup..... | 18 |
| 4.2 Transmitter power | 22 |
| 4.3 Transmit output spectrum..... | 29 |
| 4.4 Modulation tests..... | 34 |
| 4.5 Frequency and timing tests | 38 |
| 5. Receiver Measurements | 42 |
| 5.1 Test conditions and setup..... | 43 |
| 5.2 Maximum input and maximum tolerable level | 49 |
| 5.3 Receiver sensitivity..... | 50 |
| 5.4 Channel reports, RSSI, and CINR..... | 53 |
| 5.5 Interference and channel immunity (adjacent and non-adjacent channel rejection)..... | 55 |
| 5.6 Receiver preambles (and cyclic prefix)..... | 56 |
| 5.7 Hybrid ARQ..... | 56 |
| 6. Power Supply Measurements..... | 57 |
| Conclusion | 60 |
| Appendix A | 61 |
| Appendix B..... | 64 |
| Glossary..... | 65 |
| References..... | 67 |

1.0 Basic Concepts and Applications

1.1 WiMAX and the IEEE 802.16 standard

WiMAX is a broadband wireless access (BWA) technology based on the IEEE 802.16 standard. The WiMAX Forum uses the 802.16-2004 specification and subsequent corrigenda (corr 2) as a base for it to build the Mobile WiMAX standard. Where the original Fixed WiMAX profiles defined a set of parameters to meet the needs for fixed and nomadic access, the Mobile WiMAX profiles support high mobility broadband services at speeds greater than 120 km/h. Among the important features in Mobile WiMAX are OFDMA and sub-channelization. With sub-channelization, users can be allocated spectrum components across the bandwidth available to everyone. This brings the benefit of frequency diversity without having to frequency hop.

The IEEE 802.16 Working Group originally developed the broadband point-to-multipoint (PMP) standard as a wireless extension from a wired network infrastructure. The first approved air interface was based on a time division multiple access (TDMA) protocol. The interface supported time division duplex (TDD) and frequency division duplex (FDD). The architecture was originally configured for fixed antenna terminals with line of sight (LOS) propagation across the 10 to 66 GHz frequency range. The standard was later expanded to include operation in the 2 to 11 GHz range with non line of sight (NLOS) capability using a robust OFDM technique.

Mobile WiMAX is based on 802.16-2004 [1] and 802.16e-2005 [2], which is now being combined into a single document. The updated standard combines fixed and mobile services into a network architecture similar to a cellular system where a single BS can support fixed, portable, and mobile terminals. Unlike existing cellular systems, Mobile WiMAX uses an all internet protocol (IP) backbone. The standard includes an OFDMA PHY layer with sub-channelization that allows the time and frequency resources to be dynamically allocated among multiple users across the downlink (DL) and uplink (UL) sub-frames.

The dynamic allocation of the time and frequency resources can be examined using a spectrogram. A spectrogram shows how the use of the spectrum changes with time. Figure 1 shows a spectrogram of an OFDMA frame including DL and UL sub-frames. In this simplified example, two users are assigned groups of frequency subcarriers during the first three symbols in the UL sub-frame. As shown in the figure, the subcarrier or sub-channel assignments may change dynamically over the time duration of the sub-frame in response to changes in the radio channel due to fading, interference, and performance quality requirements. The physical subcarrier to sub-channel assignment or mapping is specified in the 802.16 documents. Also of note, and clearly visible in the DL signal, are the pilot subcarriers. These provide the receivers with the information needed to remove the frequency and time response of the radio channel.

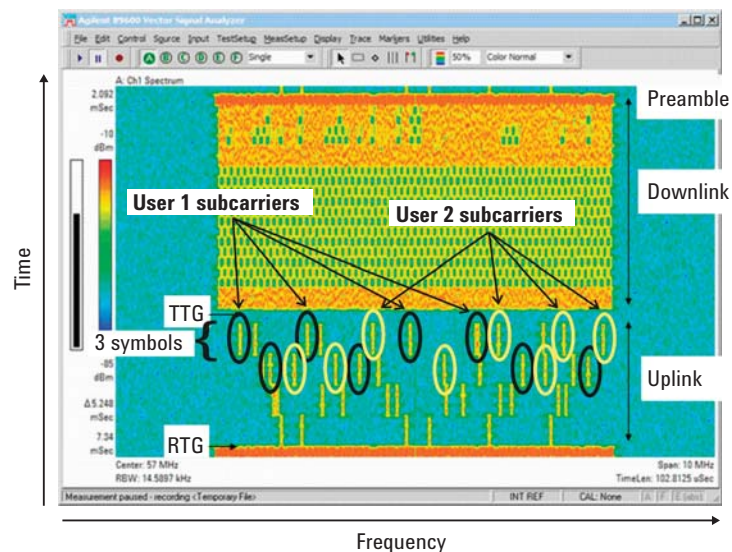

Figure 1. Spectrogram waveform showing time frequency allocations in the downlink and uplink sub-frames

1.2 WiMAX Forum waves and profiles

The WiMAX Forum is comprised of industry experts whose charter is to bring the IEEE 802.16 standard to the marketplace and to create the process for certification and inter-operability between equipment vendors. The WiMAX Forum tests operational performance based on the standard through the use of radio and protocol conformance test documentation. Subsets of system features are known as profiles, which specify the mandatory and optional features from the 802.16 standard required for baseline functionality and interoperability. The choice of profiles has been driven by spectrum availability, regulatory constraints, and market demand. To reduce the complexity involved when releasing a new radio system, the certification process has been broken down into waves where basic system functionality is introduced during Wave 1 and more advanced features, such as MIMO, are added during Wave 2. Table 1 shows some of the basic requirements for Wave 1. Over time, it is expected still further enhancements will be introduced, for example operation in a hybrid FDD mode.

Table 1. Mobile WiMAX Wave 1 profile outline

| Channel bandwidth | FFT size | 2.3 to 2.4 GHz | 2.305 to 2.32, 2.345 to 2.36 GHz | 2.496 to 2.69 GHz | 3.3 to 3.4 GHz | 3.4 to 3.8 GHz |
|-------------------|----------|----------------|----------------------------------|-------------------|----------------|----------------|
| 5 MHz | 512 | TDD | TDD | TDD | TDD | TDD |
| 7 MHz | 1024 | | | | TDD | TDD |
| 8.75 MHz | 1024 | | TDD | | | |
| 10 MHz | 1024 | TDD | TDD | TDD | TDD | TDD |

The WiMAX Forum specifies a series of protocol and radio conformance tests (RCT) for compliance and interoperability between various equipment manufacturers. Certification test houses, such as AT4 Wireless in Spain and Telecommunications Technology Association (TTA) in Korea, were among the first to be approved by the WiMAX Forum to provide conformance testing to the WiMAX profile specifications. Visit the WiMAX Forum Web site at www.wimaxforum.org for more information.

1.3 Mobile WiMAX and WiBRO

WiBRO, short for wireless broadband, is a portable internet service based on the 802.16e standard that is currently being rolled out in South Korea. WiBRO operates in the 2.3 GHz spectrum and uses the same PHY and media access control (MAC) as defined in one of the Mobile WiMAX profiles. Several of the PHY layer differences between Mobile WiMAX profiles will be summarized later in this application note.

1.4 Mobile WiMAX PHY

The Mobile WiMAX PHY uses a combination of TDD and OFDMA for downlink and uplink signaling and multiple user access. The unique features within the TDD/OFDMA frame provide frequency diversity, frequency reuse, and cell segmentation which improve the performance against fading and inter-cell interference.

1.4.1 TDD

The WiMAX OFDMA frame is configured to support a point-to-multipoint network. The 802.16e PHY supports TDD, FDD, and half-duplex FDD operation. The initial release of the Mobile WiMAX profile will only include TDD as shown in Table 1. Future releases may include FDD variants to match spectrum regulatory requirements in specific countries. For interference mitigation, system-wide synchronization is required when using TDD. Synchronization is typically achieved using a global positioning system (GPS) reference at the BS. In the event that network synchronization is lost, the BS will continue to operate until synchronization is recovered, using a local frequency reference. TDD, as specified in the WiMAX profile, enables asymmetric DL and UL traffic. Asymmetric traffic using TDD may improve the spectrum utilization and system efficiency as compared to FDD operation which typically requires equal UL and DL bandwidths. TDD uses a common channel for both UL and DL transmission allowing for a lower cost and less complex transceiver design. TDD also assures channel reciprocity which may benefit applications such as MIMO and other advanced antenna technologies.

1.4.2 OFDM and OFDMA

An OFDM system is implemented by multiplexing a single high data rate input stream into a parallel combination of low data rate streams. The parallel streams are modulated onto separate subcarriers in the frequency domain through the use of an inverse fast Fourier transform (IFFT) [4]. In a typical OFDM system, one user data occupies all the subcarriers in the channel with the exception of pilot, guard, and null subcarriers. An example of a DL sub-frame where three users are multiplexed into the same OFDM channel is shown in Figure 2. At any one instant, only one user's data is modulated onto all the available subcarriers or sub-channels across the frequency domain. In the time domain, a single user will occupy one or more OFDM symbols within the sub-frame. Multiple access is achieved by time slotting the sub-frame using TDMA. As shown in Figure 2, multiple users can sequentially share a portion of the sub-frame in time.

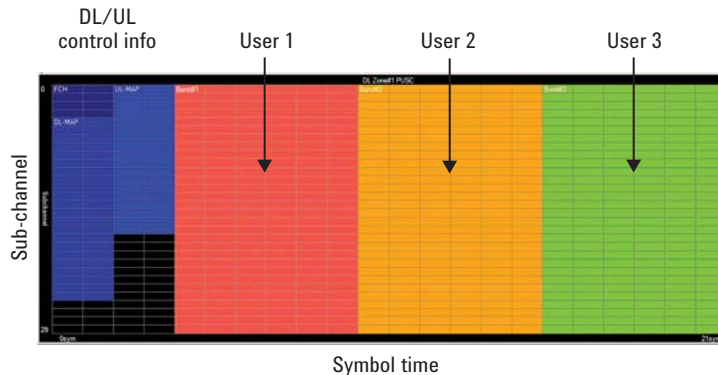

Figure 2. Time-frequency mapping for an OFDM sub-frame with three users

With the addition of subscriber mobility to the IEEE802.16 standard, a frequency domain multiple access scheme, referred to as OFDMA, was added to the WiMAX PHY. For the OFDMA system, several users may now be assigned different sets of frequency subcarriers, which effectively allow them to transmit simultaneously in time. Users may be dynamically added or dropped over the duration of the sub-frame. Figure 3 shows an example where three users share the available frequency sub-channels and can simultaneously transmit data in time. As shown in Figure 3, sub-channels may be re-allocated to other users over the duration of the sub-frame. This dynamic allocation in both time and frequency greatly improves the efficiency of the available resources but at the cost of considerable complexity to the air interface and the BS scheduler.

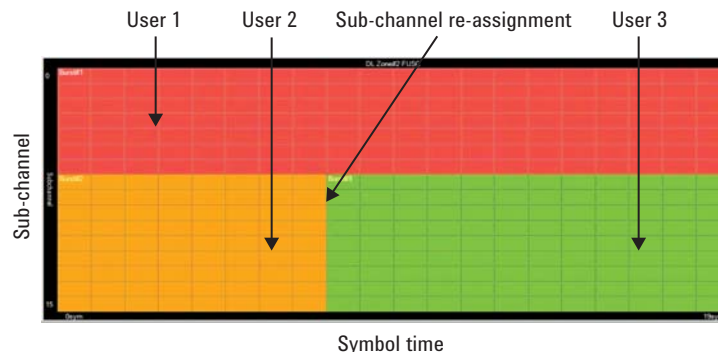

Figure 3. Time-frequency mapping for an OFDMA sub-frame with three users

1.4.3 Time and frequency parameters

The IEEE 802.16e air interface as adopted by the WiMAX Forum specifies channel bandwidths ranging from 1.25 to 20 MHz. The first release of the Mobile WiMAX system profile incorporated 5, 7, 8.75, and 10 MHz bandwidths as shown in Table 1. The bandwidth scalability in Mobile WiMAX OFDMA is achieved by adjusting the FFT size and the subcarrier spacing. For a given channel bandwidth, the subcarrier spacing is inversely proportional to the number of subcarriers and, therefore, the FFT size. The time duration of the OFDMA symbol is set by the inverse of the subcarrier spacing. Therefore by fixing the subcarrier spacing, the symbol time is automatically specified. The inverse relationship between subcarrier spacing and symbol duration is a necessary and sufficient condition to ensure that the subcarriers are orthogonal. Table 2 shows the subcarrier spacing and symbol time for the Mobile WiMAX 10 and 8.75 MHz (WiBRO) profiles using nominal bandwidths of 10 and 8.75 MHz respectively.

Table 2. WiMAX and WiBRO time and frequency parameters using a 1024-point FFT

| Parameter | Mobile WiMAX | | WiBRO |
|---|---------------------|-------------------|---------------------|
| Nominal bandwidth | 10 MHz* | 7 MHz | 8.75 MHz |
| Subcarrier spacing | 10.9375 kHz* | 7.8125 kHz | 9.7656 kHz |
| Useful symbol time ($T_s = 1/\text{subcarrier spacing}$) | 91.4 μs | 128 μs | 102.4 μs |
| Guard Time ($T_g = T_s/8$) | 11.4 μs | 16 μs | 12.8 μs |
| OFDMA symbol duration ($T_s + T_g$) | 102.9 μs | 144 μs | 115.2 μs |
| Number of symbols in frame | 47 | 33 | 42 |
| TTG+RTG | 464 PS* | 496 PS | 404 PS |
| Frame length | 5 ms | 5 ms | 5 ms |
| Sampling frequency ($F_s = \text{FFT points} \times \text{subcarrier spacing}$) | 11.2 MHz* | 8 MHz | 10 MHz |
| Physical slot (PS) ($4/F_s$) | 357.14 ns | 500 ns | 400 ns |

* Divided by 2 to change to 5 MHz signal

The Mobile WiMAX frame contains 48 symbols. The symbol time contains the actual user data and a small extension called the guard time. The guard time is a small copy from the end of the symbol that is inserted before the start of the symbol. This guard time is also called the cyclic prefix (CP) and its length is chosen based on certain assumptions about the wireless channel. As long as the CP interval is longer than the channel delay spread, inter-symbol interference (ISI) introduced by the multi-path components can be eliminated. The 802.16 standard specifies a set of CP values but the initial profile specifies a CP value of $1/8$, meaning that the guard time is $1/8$ the length of the symbol time. Table 2 shows the guard time and symbol duration for the Mobile WiMAX and WiBRO using the nominal bandwidth of 10 and 8.75 MHz respectively.

1.4.4 Frame structure

The OFDMA frame consists of a DL sub-frame and an UL sub-frame. The flexible frame structure of the TDD signal consists of a movable boundary between the DL and UL sub-frames. A short transition gap is placed between the DL and UL sub-frames and is called the transmit-receive transition gap (TTG). After the completion of the UL sub-frame, another short gap is added between this sub-frame and the next DL sub-frame. This gap is called the receiver-transmit transition gap (RTG). The minimum time durations for these transition gaps are called out in the 802.16 standard and are a function of the channel bandwidth and the OFDM symbol time. It is typical to define these transition gaps in terms of physical slot (PS) units. A PS is a unit of time defined as $4/(\text{sampling frequency})$. The sampling frequency is equal to the FFT size multiplied by the channel spacing. Table 2 shows the PS for the 10 and 8.75 MHz cases using a 1024-point FFT.

An example of a Mobile WiMAX frame is shown in Figure 4. This figure shows the time-frequency relationship where the symbol time is shown along the x-axis and the logical sub-channels along the y-axis. Logical sub-channels are groupings of frequency subcarriers assigned to individual users. The concept of sub-channels and zones will be covered later in this application note. Figure 4 shows the DL and UL sub-frames separated by the TTG and ending with the RTG. The figure also shows the relative position of the preamble, frame control header (FCH), downlink media access protocol (DL-MAP), and uplink media access protocol (UL-MAP) whose functions will be discussed in the next section.

There are a number of significant differences in the UL signal compared to the DL. They reflect the different tasks performed by the BS and MS, along with the power consumption constraints at the MS. Differences include:

- No preamble, but there are an increased number of pilots. Pilots in the UL are never transmitted without data subcarriers
- The use of special CDMA ranging bursts during the network entry process
- Data is transmitted in bursts that are as long as the uplink sub-frame zone allows, and wrapped to further sub-channels as required

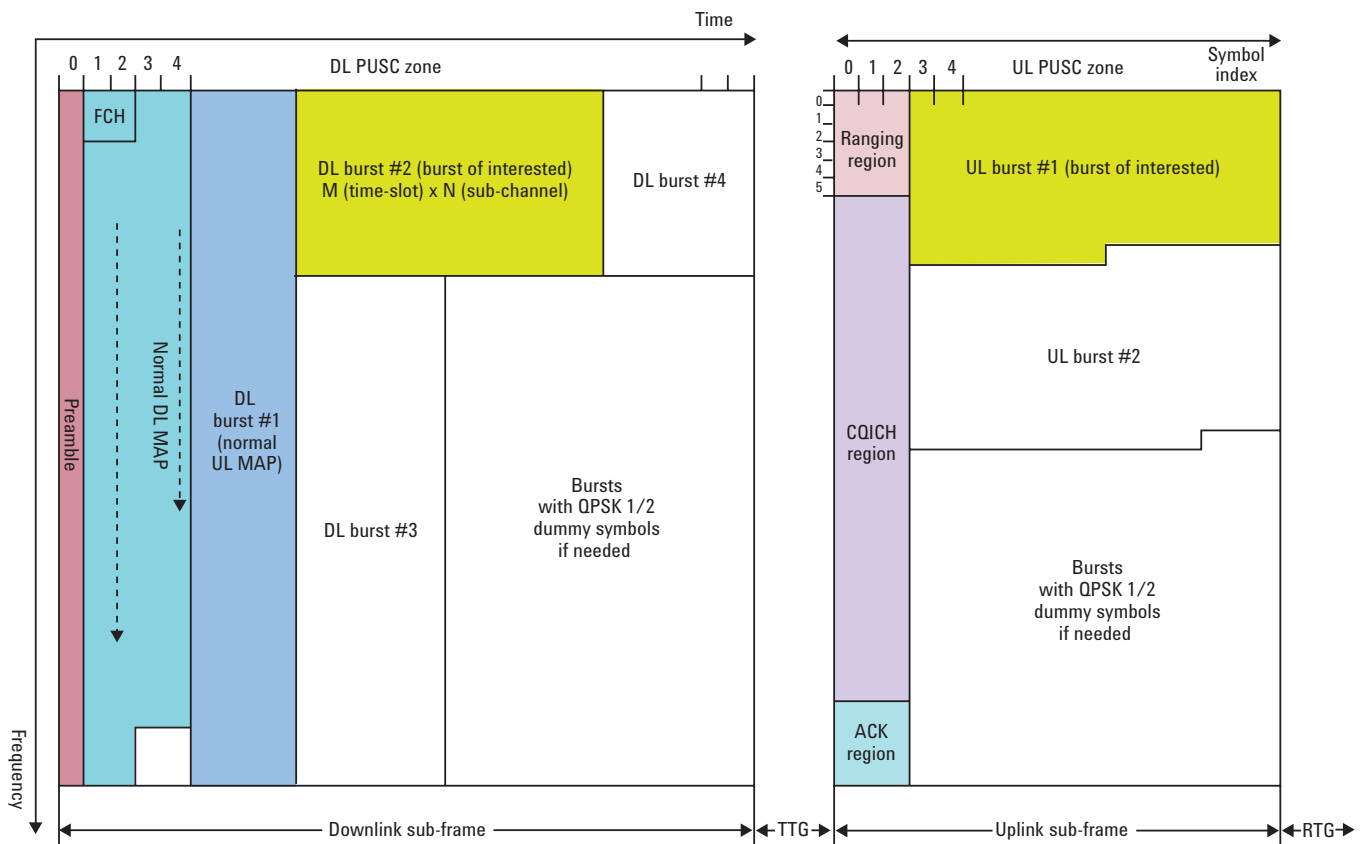

Figure 4. OFDMA frame structure for TDD

1.4.5 Preamble

The DL sub-frame always begins with one symbol used for BS identification, timing synchronization, and channel estimation at the MS. This symbol is generated using a set of 114 binary pseudo random number (PN) sequences, called the preamble ID, of 568 length. The data in the preamble is mapped to every third subcarrier, using BPSK, giving a modest peak-to-average power ratio (compared to the data sub-channels). The preamble subcarriers are boosted by a factor of eight over the nominal data subcarrier level. There are no preambles in the UL except for systems using adaptive antenna systems (AAS). For the case when there is no UL preamble, the BS will derive the required channel information based on numerous pilot subcarriers embedded in the UL sub-channels.

1.4.6 FCH

The FCH follows the DL preamble with a fixed location and duration. The FCH contains the downlink frame prefix (DLFP). The DLFP specifies the sub-channelization, and the length and coding of the DL-MAP. The DLFP also holds updates to the ranging allocations that may occur in subsequent UL sub-frames. In order that the MS can accurately demodulate the FCH under various channel conditions, a robust QPSK rate 1/2 modulation with four data repetitions is used.

1.4.7 DL-MAP and UL-MAP

The DL-MAP and UL-MAP provide sub-channel allocations and control information for the DL and UL sub-frames. The MAP will contain the frame number, number of zones, and the location and content of all bursts. Each burst is allocated by its symbol offset, sub-channel offset, number of sub-channels, number of symbols, power level, and repetition coding.

1.4.8 Channel coding

There are various combinations of modulations and code rates available in the OFDMA burst. Channel coding includes the randomization of data, forward error correction (FEC) encoding, interleaving, and modulation. In some cases, transmitted data may also be repeated on an adjacent subcarrier.

1.4.9 Randomization

Randomization of the data sequence is typically implemented to avoid the peak-to-average power ratio (PAPR) increasing beyond that of Gaussian noise, thus putting a boundary on the nonlinear distortion created in the transmitter's power amplifiers. It can also help minimize peaks in the spectral response.

1.4.10 FEC

The Mobile WiMAX OFDMA PHY specifies convolutional coding (CC), convolutional turbo coding (CTC), and repetition coding schemes. When repetition coding is used, additional blocks of data are transmitted on an adjacent sub-channel. CTC can give about a 1 dB improvement in the link performance over CC.

1.4.11 Interleaving

Interleaving is a well known technique for increasing the reliability of a channel that exhibits burst error characteristics. Interleaving involves reordering the coded data, which spreads any errors from burst of interference over time, increasing the probability of successful data recovery.

1.4.12 Modulation

There are three modulation types available for modulating the data onto the subcarriers: QPSK, 16QAM, and 64QAM. In the UL, the transmit power is automatically adjusted when the modulation coding sequence (MCS) changes to maintain the required nominal carrier-to-noise ratio at the BS receiver. 64QAM is not mandatory for the UL. Binary phase shift keying (BPSK) modulation is used during the preamble, on the pilots, and when modulating subcarriers in the ranging channel.

The BS scheduler determines the appropriate data rates and channel coding for each burst based on the channel conditions and required carrier-to-interference plus noise ratio (CINR) at the receiver. Table 3 shows the achievable data rates using a 5 and 10 MHz channel for both DL and UL transmissions.

Table 3. Mobile WiMAX PHY data rates

| Modulation | Code rate | 5 MHz channel | | 10 MHz channel | |
|------------|-------------|---------------------|---------------------|-------------------|-------------------|
| | | Downlink rate, Mbps | Downlink rate, Mbps | Uplink rate, Mbps | Uplink rate, Mbps |
| QPSK | 1/2 CTC, 6x | 0.53 | 0.38 | 1.06 | 0.78 |
| | 1/2 CTC, 4x | 0.79 | 0.57 | 1.58 | 1.18 |
| | 1/2 CTC, 2x | 1.58 | 1.14 | 3.17 | 2.35 |
| | 1/2 CTC, 1x | 3.17 | 2.28 | 6.34 | 4.70 |
| | 3/4 CTC | 4.75 | 3.43 | 9.50 | 7.06 |
| 16QAM | 1/2 CTC | 6.34 | 4.57 | 12.07 | 9.41 |
| | 3/4 CTC | 9.50 | 6.85 | 19.01 | 14.11 |
| 64QAM | 1/2 CTC | 9.50 | 6.85 | 19.01 | 14.11 |
| | 2/3 CTC | 12.67 | 9.14 | 26.34 | 18.82 |
| | 3/4 CTC | 14.26 | 10.28 | 28.51 | 21.17 |
| | 5/6 CTC | 15.84 | 11.42 | 31.68 | 23.52 |

1.4.13 Time-frequency mapping

Data is mapped to physical subcarriers in two steps. For the first step, which is controlled by the scheduler, data is mapped to one or more logical sub-channels called slots. A slot is a basic unit of allocation in the frequency-time grid, being one sub-channel in frequency by one, two, or three symbols in time. Depending on the application, slots may be further grouped and assigned to segments, which can be used by the BS for different sectors in a cellular network.

For the second step, the logical sub-channels are mapped to physical subcarriers. Pilot subcarriers are also assigned during this mapping process. The physical data and pilot subcarriers are uniquely assigned based on the type of sub-channelization which will be discussed in the next section.

1.4.14 Sub-channelization and zones

Sub-channelization is a sophisticated form of frequency division multiple access (FDMA) where multiple subcarriers are grouped into sub-channels to improve system performance. There are two types of subcarrier allocations that form a sub-channel. The first type, called distributed allocations, pseudo-randomly distributes the subcarriers over the available bandwidth. This type of allocation provides frequency diversity in frequency-selective fading channels and inter-cell interference averaging. Distributed allocation of subcarriers is well suited for mobile applications. The second type of subcarrier allocation, called adjacent allocation, groups subcarriers adjacent to each other in the frequency domain. Adjacent allocation is useful for frequency non-selective and slowly fading channels, and for implementing adaptive modulation and coding (AMC). Adjacent allocation is typically used in fixed and low mobility applications in which the sub-channel with the best frequency response can be assigned to the subscriber.

Permutation zones, or zones, are groupings of contiguous symbols that use a specific type of sub-channel assignment. The OFDMA PHY specifies seven zone types: FUSC, OFUSC, PUSC, OPUSC, AMC, TUSC1, and TUSC2 [5]. PUSC, FUSC, and AMC are more likely to be encountered in practical systems. All zones except for AMC use the distributed allocation of subcarriers for sub-channelization. A brief description of each zone is included in the next section. A single frame may contain one or more zones. The DL sub-frame requires at least one zone, always starting with PUSC. It is reasonable to expect several types of zones in a frame. The exact number depends on network conditions.

1.4.15 Matrix A space time coding, Matrix B spatial division multiplexing (also known as multi input multi output (MIMO))

Zones can be configured to make use of multi-antenna technology, including phased array beamforming, STC, and MIMO techniques. Matrix A is an Alamouti-based transmit diversity technique, which involves taking pairs of symbols and time-reversing each pair for transmission on a second antenna. Matrix B uses MIMO spatial division multiplexing to increase the channel capacity. For downlink MIMO, user data entering the BS is split into parallel streams before being modulated onto the OFDMA subcarriers. As with the single channel case, channel estimation pilots are interleaved with the data subcarriers. For MIMO operation, the pilots are made unique to each transmit antenna to allow a dual receiver to recover four sets of channel coefficients. This is what is needed to remove the effect of the signal coupling that inevitably occurs between transmission and reception.

The MS is initially only required to have one transmit antenna and support open loop MIMO. More advanced, closed loop MIMO operates by the MS transmitting regular encoded messages back to the BS, which provide the closest approximation to the channel seen by the MS. The BS then pre-codes the MIMO signal before transmission, according to the channel state information (CSI) provided by the MS. The BS may also have the facility to control the single transmitters from two MSs to act together to create a collaborative MIMO signal in the UL.

Matrix A and Matrix B techniques can be applied to PUSC and AMC zones, to be described next.

1.4.16 Downlink partial usage of sub-channels (DL PUSC)

This is the default zone required at the start of all DL sub-frames following the preamble. In this zone, pairs of pilots swap positions on alternate symbols, averaging one in seven of the subcarriers. If pilots are dedicated, it means they are only transmitted when there is corresponding data.

Subcarriers are grouped into clusters of 14 contiguous subcarriers per symbol. A sub-channel is a group of two clusters. A slot is one sub-channel over two OFDM symbols. The sub-channels in a DL PUSC zone can also be mapped into larger groups called segments. There can be up to three segments created from these larger sub-channel groupings.

The first PUSC zone is always single in single out (SISO). Further PUSC zones can be specified for multi-antenna MIMO use.

1.4.17 Uplink partial usage of sub-channels (UL PUSC)

For this zone type, four contiguous subcarriers are grouped over three symbols. This grouping is called a tile. Six tiles make a sub-channel. For the UL PUSC, the slot is defined as one sub-channel that occurs over the three symbols. Pilots are incorporated within the slot, their position changing with each symbol. Over the course of one tile, one in three subcarriers is a pilot.

1.4.18 Adaptive modulation and coding (AMC)

In this zone, which has a slightly wider occupied bandwidth than the PUSC and FUSC, a contiguous block of subcarriers form a sub-channel. The structure of this zone is the same for the DL and the UL. The slot is defined as a collection of bins that follow the $N \times M$ formula. N is the number of bins and M is the number of OFDM symbols. A bin (symbol) consists of nine contiguous subcarriers. A 2×3 AMC structure is used in Wave 2 of Mobile WiMAX. A slot is one sub-channel wide in logical frequency allocation. The length changes according to the zone. AMC is also used with AAS, which provides interference mitigation by using antenna directionality. The pilots in the DL change position in a rotating pattern that repeats every fourth symbol.

1.4.19 Downlink full usage of sub-channels (DL FUSC)

This type of zone uses all subcarriers and provides a high degree of frequency diversity. Subcarriers are divided into 48 groups of 16 subcarriers. A sub-channel is formed by taking one subcarrier from each group. A slot is defined as one sub-channel over one OFDMA symbol. The pseudo-random distribution of data changes with each OFDMA symbol over the length of the zone, which can be useful when attempting to mitigate interference through the use of what is effectively a type of frequency hopping. The pilots are regularly distributed. Their position alternates with each symbol.

1.4.20 Downlink optional FUSC (DL OFUSC)

The optional FUSC is a slight variation to the FUSC where pilot subcarriers are evenly spaced by eight data subcarriers.

1.4.21 Uplink optional PUSC (UL OPUSC)

This zone is the same as the UL PUSC except that it uses a tile size that is three subcarriers wide by three symbols long.

1.4.22 Tile usage of sub-channels (TUSC1 and TUSC2)

These zones are only available in the DL using AAS. They are both optional and similar to DL PUSC and OPUSC but use a different equation for assigning the subcarriers within the sub-channel.

With the exception of the DL PUSC, which is assigned after the DL preamble, all of the zones described below can be assigned in any order within the frame. The switching points between zone types are listed in the DL MAP. Figure 5 shows an example of an OFDMA frame with the several different types of zones. As shown in the figure, the DL PUSC zone follows the preamble and is the only mandatory zone in the frame. The DL sub-frame also shows a second PUSC zone, a FUSC zone, and an AMC zone. The UL sub-frame follows the TTG and, in this example, contains a PUSC, OPUSC, and AMC.

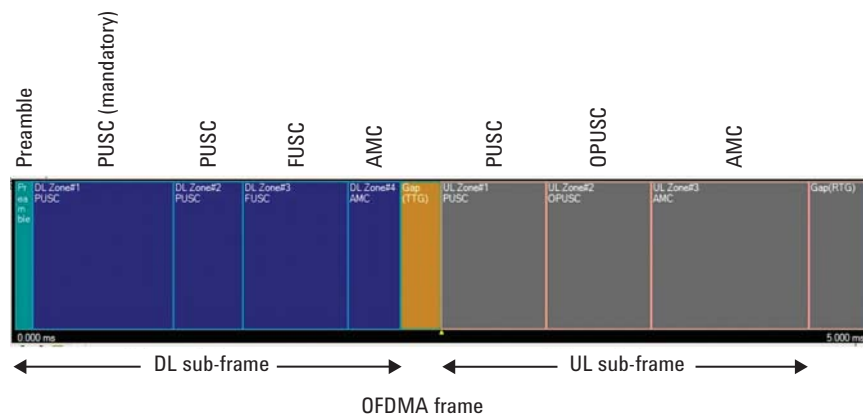

Figure 5. Example of an OFDMA frame with multiple zones

1.5 Control mechanisms

1.5.1 Ranging

Ranging is used for several functions such as bandwidth requests, timing and power control, periodic maintenance, and handover. Initial ranging, using the special CDMA ranging burst, is used by any MS that wishes to synchronize to the system for the first time. Default time and power parameters are used to initiate communication and then adjusted until they meet acceptance criteria. Periodically these parameters are updated during a maintenance interval. A ranging channel is defined in the UL and composed of one to eight adjacent sub-channels. A PN code sequence is chosen by the MS and this sequence is modulated onto the subcarriers. The PN sequence provides a spreading gain that allows multiple ranging transmissions to be simultaneously received by the BS thus defining this technique as CDMA ranging [5].

1.5.2 Fast feedback

Fast feedback slots are assigned to individual MSs when the BS requires information from the MSs in a very timely manner. Information concerning CINR, MIMO, antenna, and spatial multiplexing are all examples of time critical parameters that can make use of the fast feedback channel. A portion of the beginning of the UL sub-frame is allocated for this function. Orthogonal encoding is used to allow for multiple MSs to transmit simultaneously within the same slot.

1.5.3 Hybrid automatic repeat request (HARQ)

A MAC level automatic repeat request (ARQ) is used by the receiver to provide feedback on successfully received and missing blocks of data. An ARQ mechanism greatly reduces the error rate at the expense of adding a time delay. The major differences between ARQ and HARQ are that ARQ discards previously transmitted data while HARQ combines the previous and retransmitted data to gain time diversity. HARQ also makes use of faster responding physical layer ACK and NACK packets, transmitted from the receiving device. In operation, HARQ operation is typically planned to operate with approximately a ten percent packet error rate, minimizing delays in repeat packet transmission, which has a dramatic effect on data throughput. HARQ is one element in the Mobile WiMAX profile that can deliver high performance with mobility at speeds in excess of 120 km/h.

1.6 Media access control (MAC) layer

Mobile WiMAX is based on IP or packet-switched services, which provides for a common network core. Data transfer involves the creation of a service flow, a unidirectional transport mechanism from the MAC through the PHY.

The MAC layer of the 802.16 standard was developed to support voice, data, and video under bursty conditions and high peak demands. The MAC is connection-oriented with each connection assigned a service class based on the type of quality of service (QoS) that is required by the MS. The MAC layer manages the radio resources to efficiently support the QoS for each connection established by the BS. There are five types of data delivery services available in the Mobile WiMAX profile. Table 4 shows a summary of the available service classes based on the typical application.

Table 4. Mobile WiMAX data delivery services and application

| Service class | Real time | Data rate | Application |
|---------------------------------|-----------|-----------|-----------------|
| UGS (unsolicited grant service) | Yes | Fixed | VoIP |
| RT (real time) | Yes | Variable | Streaming video |
| NRT (non-real time) | No | Variable | FTP |
| BE (best effort) | No | Variable | Web surfing |
| ERT (extended real time) | Yes | Variable | VoIP |

1.6.1 The network entry process

Each air interface in the MS will have a 48-bit universal MAC address that is used during the initial ranging and authentication process. The MS begins network entry and initialization by searching over a predetermined list of channel frequencies for the preamble of an OFDMA frame. When a preamble is found, the MS begins to determine the DL and UL parameters using the FCH and management data bursts, the DL channel descriptor (DCD), and the UL channel descriptor (UCD.) At this point, the MS has the necessary information to transmit on an UL ranging slot. The MS randomly selects an available slot from the list contained in the UL-MAP and sends a ranging request (RNG-REQ) message. The BS replies with a message with the power, timing, and frequency adjustments required by the requesting MS.

Once the MS's timing and transmit power have been properly adjusted, the BS and MS negotiate which PHY and MAC capabilities will be used for subsequent communication. Signals from the MS are distinguished at the PHY using different codes called the permutation base (like the separation of the BS signals using the preamble ID.) Unlike WLAN, which uses a MAC address, each data burst is logically marked for a specific receiver using a connection identifier (CID.) Next, the MS is authenticated and receives an IP address using DHCP. At this point the MS is managed by the BS and additional timing and power adjustments are performed during a maintenance cycle called periodic ranging.

1.6.2 MAC scheduler

The MAC scheduler is located at each BS and is responsible for efficiently allocating the time and frequency resources in response to bursty traffic and time-varying channel conditions. The resource allocations are delivered to the MSs using the DL-MAP and UL-MAP located at the beginning of each frame. The scheduler determines the ordering of the data packets and the type of zone(s) on a frame by frame basis.

1.6.3 Handover

The handover (HO) process allows a MS to switch to another BS in order to improve its QoS, which may have degraded due to movement across cell boundaries or changing channels conditions. The Mobile WiMAX profile specifies three techniques for hard HO and soft HO. Hard HOs use a break-before-make approach and are typically sufficient for data services. Soft HOs, while complex to implement and administer, are beneficial for applications that require low-latency such as VoIP.

2.0 The Mobile Station

This section describes the architecture of the MS. In many ways it is very similar to that of a WLAN module. Like a WLAN device, or other network card, the WiMAX card is an adapter. It takes data packets designed for wired transmission and converts them to a different packet structure suitable for radio use.

The MS, sometimes referred to as the SS or customer premises equipment (CPE), consists of four major parts:

- Driver software
- Digital interface
- Baseband processor
- Radio transceiver

The driver software is loaded onto the host processor, where a suitable application can then call the resources of the card. For a Microsoft® application, the driver will typically take the form of a dynamic link library (DLL).

The host application plays an important role in testing. The type of application can be split into two main groups: those for calibration and testing, and those for use by the subscriber to the network.

The driver makes use of a specific digital interface, for example a PC card (PCMCIA), mini PC, or USB. The WiMAX device has to contain this hardware interface adapter.

The process of data packet adaptation may take place either as a shared role with the host and the device, or may be completely integrated into the WiMAX device. The baseband processor provides conversion of the modified packets into the OFDM format needed for RF transmission. The baseband processor also controls functions such as frequency and amplitude setting, using calibration constants where appropriate to ensure the power transmitted from the device, and the reports it gives to the BS are correct.

The radio transceiver is frequently going to be designed for TDD operation, although over time this will change to allow for (hybrid (H)) FDD too. The dominant format is for two receivers and one transmitter, which allows for MIMO operation in the downlink, as well as providing the more general performance gains from the use of receive diversity. In the future, a second transmitter may be added for dual stream uplink MIMO operation.

As shown in Figure 6, the RF transceiver has the following major sub-components:

- Dual antenna: May be separate from main card
- Front end module: Consists of low noise and power amplifiers, filters, and switches
- Up/Down frequency conversion: Contains a phase-locked loop local oscillator, switchable amplification, and signal filtering
- Digital-to-analog conversion: The converters may be part of the baseband device

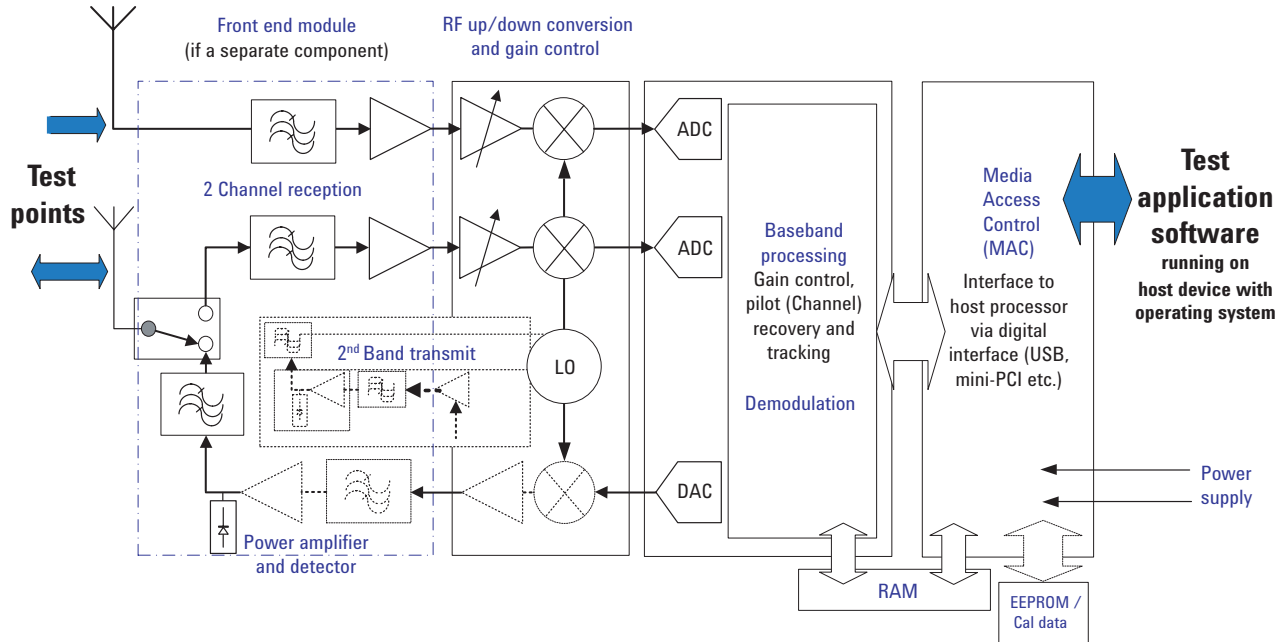

Figure 6. MS block diagram

The digitized signal is fed to baseband processing, which first synchronizes in time and frequency to the BS signal. The signal then goes through the process of training the demodulator using the preamble and either SISO or MIMO pilots embedded in the signal.

The software and physical hardware interfaces available for testing determine which tests can be done. The RF is typically available using a micro-connector that disconnects the antenna feed, so that the transmission path impedance match is maintained. If the device under test (DUT) is an RF or baseband only, differential impedance IQ interfaces need to be supported. IQ probing, as well as direct connection, is possible using both the oscilloscope and the Agilent MXA signal analyzer.

The power source for the module can take a number of forms, e.g. a Li-Ion battery or the power supply of the host device. The smaller the battery, the more critical power management techniques become, from switching off the transmitter to effective implementation of idle and sleep modes.

3.0 PHY Layer (RF) Test Suite

The prior sections in this application note described the TDD PHY layer for Mobile WiMAX. It is useful to have an understanding of concepts such as FFT, OFDMA, uplink, downlink, zones, slot, and symbol as we prepare to discuss measurements on the PHY layer.

There are two main sources of measurement definitions on Mobile WiMAX: those from the IEEE standard (802.16e), and others created by the WiMAX Forum. IEEE 802.16-2004 and 2005 merged Sections 8.4.10/11/12/13 detail the measurements that concern the performance of the PHY layer and the conditions under which they are performed. The Mobile Radio Conformance Test (MRCT) document from the WiMAX Forum specifies the test requirements for radio conformance.

Sections 4, and 5 discuss MS transmit and receive measurements, and key measurement considerations. Familiarity with measurement concepts involving RF signals and use of tools such as the Agilent 89600S Series vector signal analyzer (VSA) and N5182A MXG vector signal generator (VSG) are helpful to doing these measurements.

Both the signals from the BS, which affect MS receiver results, and the mobile transmitter can vary symbol by symbol. Defining the test signal and the measurement gating interval being used (intentionally or not) is vital to achieving traceable and repeatable measurements.

Note: To understand transmitter performance in a BS, refer to Agilent's *IEEE 802.16e WiMAX OFDMA Signal Measurements and Troubleshooting*, application note 1578, literature number 5989-2382EN.

4.0 Transmitter Measurements

The transmitter path in the MS consists of baseband processing, IQ modulation, filtering, frequency up conversion to RF, and power amplification. To confirm all these stages are function properly, it is recommended to start with the basics of getting frequency, power, and timing correct, before moving on to modulation measurements frequency (bandwidth). This approach means important signal problems will be identified fast.

The danger of missing fundamental problems is particularly acute in applications such as IEEE 802.16's OFDMA due to the signal's complexity and the possibility that demodulation will fail due to configuration discrepancies such as preamble ID, PRBS setting, or incorrect definition of data bursts. This is why it is important to isolate problems as early as possible in the measurement and troubleshooting process and eliminate the maximum number of simple signal problems before attempting digital demodulation. This is especially true when working on baseband digital signal processor (DSP) operations for creating such things as signals with correct modulation and pilot configuration. Experience has shown there are numerous possibilities for demodulation measurement problems in the initial turn on.

Given the burst nature of the transmitted signal and the different signal formats, this section discusses the conditions under which a test is performed, the measurements set up, aspects of device control, and specifics of the tests.

4.1 Test conditions and measurement setup

Measurements on the transmitted signal from the MS require set up information for the burst, including bandwidth, frequency, UL/DL ratio or sub-frame duration, FFT size, zone type, and MAP (sub-channel and slot allocation). This information allows the test equipment to perform the appropriate frequency, power, time, and modulation measurements.

As discussed later, using a vector signal analyzer with an auto zone detect feature, such as the Agilent 89600S Series VSA, simplifies demodulation measurements because the VSA detects the bursts without having to know the MAP. Basic frequency and time measurements do not require burst information, as these measurements are done prior to doing demodulation. Time gated measurements are often essential, and generally offer greater measurement clarity.

4.1.1 Differences between a DL and UL

The UL signal has no preamble, but it has more sub-channels than the DL (35 instead of 30 for a 10 MHz PUSC), different zone specifications, and data bursts that are "wrapped" back to the initial symbol they are using if more slots are required. Currently, there is only one transmitter in the MS, whereas the BS can have two or more transmitters. Live UL signals will also contain ranging bursts, sounding bursts, and channel quality indicator (CQI) bursts.

Figures 7 to 9 show a WiMAX TDD frame and the various parts of the frame for a 10 MHz signal created in the Agilent N7615B Signal Studio software for Mobile WiMAX. Burst 1 in Figure 9 shows the burst wrapping in the UL signal.



Figure 7. WiMAX TDD frame showing the DL with the preamble and PUSC zone, and the UL with a PUSC zone. The yellow trace shows power envelope

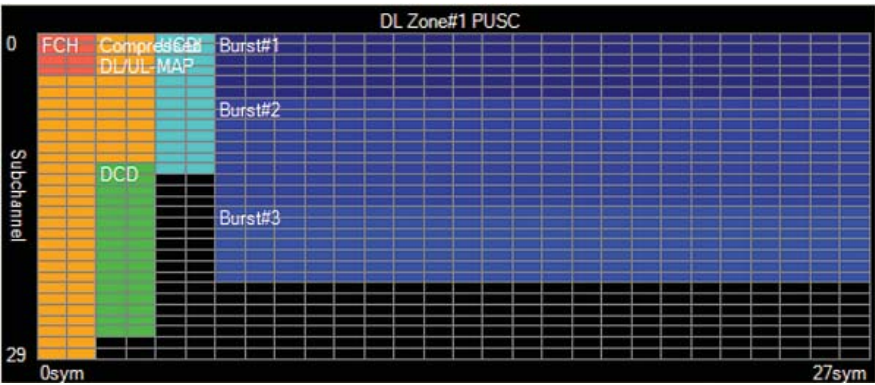

Figure 8. DL zone showing the FCH, DCD, DL/UL maps, and three data bursts occupying 28 symbols

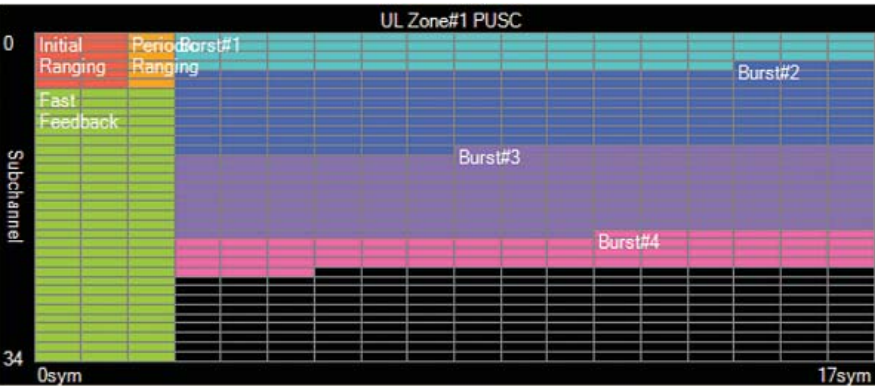

Figure 9. The UL zone showing ranging, fast feedback bursts, and four data bursts, occupying 18 symbols

Figure 10 shows measurements made on this signal using the Agilent VSA 89601A software for Mobile WiMAX, highlighting differences in the DL and UL. The upper left trace shows the power versus time waveform of the burst. The upper right trace illustrates the time waveform showing the nine symbols in UL. The center left graph shows the frequency domain representation of the DL preamble, and the lower left shows a data burst in a PUSC zone. The center right trace shows the sparse use of subcarriers in a ranging burst, while the lower right graph shows the spectrum of a data burst symbol in the UL.

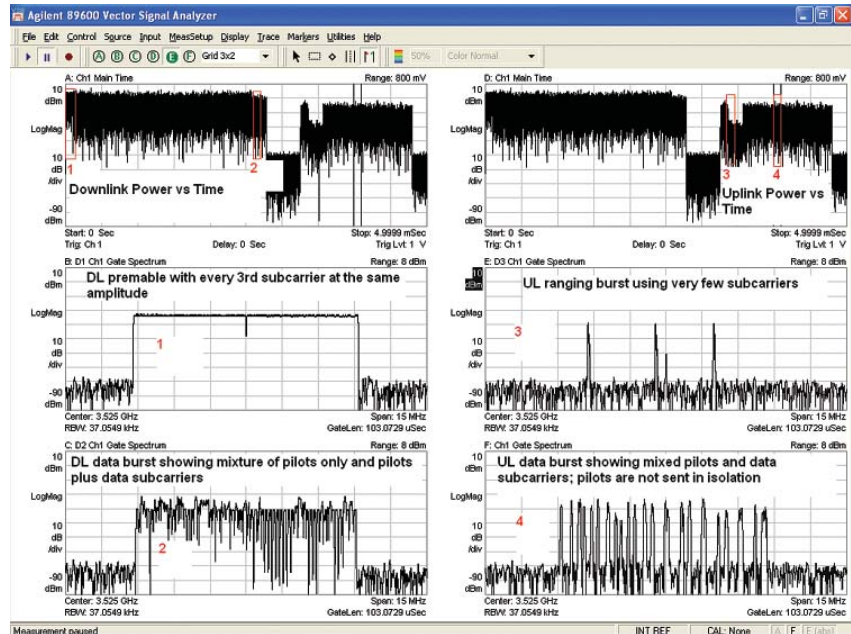

Figure 10. Measurement of a Mobile WiMAX frame with VSA

The transmission from a BS transmitter starts with a preamble. For a PUSC zone, the UL burst uses multiples of three symbols and the DL burst has multiples of two symbols plus the preamble which occupies one symbol.

4.1.1.1 Test modes MS test modes and device control

The IEEE and WiMAX Forum documents specify test conditions and performance requirements. There is no single test mode, but the frame design and burst shapes are defined in Appendix 2 of the MRCT.

Transmitter tests may use a combination of local control from test application software and the uplink MAP sent as an RF signal. Alternatively, a technique called uplink padding can force the transmitter to send signals with a fixed burst shape. Receiver testing using the IP ping command can serve a dual purpose for transmitter test, since the data will be returned. The physical layer HARQ test mode allows receiver testing using HARQ acknowledgements, and also ensures a fixed relationship between the subcarrier power and that measured with a general purpose time-gated power measurement.

Test configurations need to be set using local, direct, device control or using BS emulation over the RF connection with control of the scheduler. The scheduler determines the transmit timing and the format of DL and UL signals. There are three configurations for device testing, with progressively less control of the exact results.

The wide range of choices in the OFDMA transmission parameters creates the potential for considerable uncertainty when testing. As explored in the transmitter and receiver test sections of this application note, this uncertainty can result in either the wrong result or variation between results. To mitigate the uncertainty and variation in testing, the pros and cons of each test method are described in Table 5.

Table 5. Summary of factors affecting choice of test configuration

| Configuration | Features | Precise signal definition | Speed of operation | Network entry required | Complexity |
|-------------------------|--|--|--|---|---|
| Vendor test mode | <ul style="list-style-type: none"> • Lowest cost • Greatest control • Most likely to give fastest test methods • Straightforward to ensure only single data bursts are sent | Best | Fastest Unidirectional receiver test | No. DUT may still be configured to synchronize to test source | Simplest hardware. Need access to vendor software |
| BS emulation | <ul style="list-style-type: none"> • Involves the additional cost for the link • The device is required to go through network entry process before testing • Gives control over the RF, but frequency and other basic settings still need to be made using application software specific to the DUT | Good. DUT may transmit asynchronous control bursts | Depends on dynamic response of DUT to RF signaling | Yes | Can be fully integrated, e.g. to give receiver and transmitter test results |
| BS | <ul style="list-style-type: none"> • Unless scheduler control is available, data transfer will involve significant variations in the format of both downlink and uplink transmissions | Need scheduler control | | Yes | Requires system customization |

Software to control device operation is always required during chipset development. It can be obtained through negotiation with the silicon vendor or, in a number of cases, with N7300A Series chipset automation software from Agilent. For transmitter testing, the analyzer configuration should be set to match that of the DUT. For an un-distorted signal this may be automatic. For receiver testing, the signal generated has to match what is expected by the receiver. Typically, the frame number may, but does not need to, increment.

If no such test software is available, tests can be run using the Agilent E6651A Mobile WiMAX test set, which provides a BS emulator and can use a more general user application for the DUT. In this case, the BS emulator determines the signal parameters used during testing and provides receiver test results such as PER and provides data reports such as the received signal strength indication (RSSI) and carrier-to-interference plus noise ratio (CINR). The E6651A can be used for advanced testing involving signaling, such as power control and HARQ receiver tests, and emulating a BS in testing.

Some of the features of normal system operation can be used to test basic operation of a device. For example, the MS will synchronize to the BS signal before transmission and take burst allocation information from the uplink MAP. This control loop can be tested as part of the receiver verification by measuring the frequency and timing accuracy of transmissions from the DUT.

4.1.2 Measurement triggering

Where available, the most straightforward trigger to use is one synchronized to the Mobile WiMAX 5 ms frame. This signal may come from the BS or BSE. However, the RF signal may be the only one provided; in this case a wideband envelope detector provides the necessary triggering. The envelope of the RF signal varies continuously depending on frame and burst design. A trigger holdoff function is needed to remove jitter from the trigger timing. For many measurements, including spectrum, power, and CCDF, it is important to measure a specific portion of the RF burst, or sub-frame. Testing is performed using time gating. Given below is an example based on the Agilent N9020A MXA and steps that need to be taken to obtain a stable result.

MXA RF burst triggering on an UL signal

- Make the MS signal larger than the BS by > 10 dB
- Set the Trigger Holdoff to be longer than the signal being measured
<Trigger><More><Trigger Holdoff> 2.2 ms
- Adjust the trigger level in the measurement of interest
<Mode><OFDMA>
<Meas><More><Modulation Analysis> (or other measurement function)
<View><More><Power vs Time>
Adjust <AMPTD><Ref Value> until MS signal is within the top 10 dB of the PvT scale
<Trigger><RF Burst><RF Burst><Trigger Level> approximately the same level as the top of the MS transmit power level

The position of the RF envelope trigger detector in the measurement path is important. If it is placed before any signal filtering it can be used for all measurements, but in general use it does not allow the rejection of other signals that could be present. In the MXA, the RF burst trigger is placed after preliminary filtering. For spectrum emission mask this means the RF level may drop below a detectable level, in which case the periodic timer can be used. The interval is set to 5 ms to match the frame and the timer is synchronized to the RF burst when it is present at the center frequency.

For digital demodulation measurements using the 89600 VSA, the trigger is not needed if the pulse search function is enabled and only the UL signal is present. The 89600 will automatically recover both DL and undistorted single burst UL signals.

The 89600 VSA signal recording functioning is an extremely powerful troubleshooting tool. Multiple frames of a signal may be captured to a file for later examination. Triggering issues may be avoided by using the following configuration:

```
<RBW> Frequency Points <Auto> (version 8 and above allow automatic coupling of  
FFT points and time interval)  
<Time>< Max Overlap(Avg Off)> 0%  
<Main Time Interval> 5 ms
```

With the measurement paused, using the <Control><Player> function, drag the start point of the display to just before the wanted signal. Crop the time record to this point.

The playback will now step forward in exactly 5 ms increments, allowing the measurement on each frame without needing to set any trigger levels. This is particularly useful if the signal contains a mixture of DL and UL signals at similar power levels.

The time gating feature available in Agilent wideband power meters helps to make burst power measurements and requires knowledge of burst timing.

Note: Additional information on power meters and measurements is available in *Agilent N1911A/N1912A P-Series Power Meters for WiMAX Signal Measurements*, Demonstration Guide, literature number 5989-6423EN.

4.2 Transmitter power

4.2.1 Transmit power on UL — how pilot and data subcarrier signals combine

In this section, we discuss how the pilots and data subcarriers contribute to transmitted UL power. We also discuss how to measure the power on pilots and data subcarriers with the VSA.

OFDM is the sum of many narrow-band signals in frequency, measured over a certain number of symbols in time. The signal power is that of pilots (un-boosted in the UL) and data subcarriers. In turn, this is dependent upon the burst type and any power boosting being applied.

$$\begin{aligned} & \text{Total data power (dBm)} \\ & = DPwr \text{ (dBm)} + 10\log\{10 \text{ (number of active data subcarriers)}\} \end{aligned}$$

Where

$DPwr$ = The power per data subcarrier

$$\begin{aligned} & \text{Total pilot power (dBm)} \\ & = PPwr \text{ (dBm)} + 10\log\{10 \text{ (number of active pilot subcarriers)}\} \end{aligned}$$

$PPwr$ = The power per pilot subcarrier

$$\text{Symbol Power}_{(Data + Pilot)} = 10\log \{10^{(Data \text{ power}/10)} + 10^{(Pilot \text{ power}/10)}\}$$

The ability of the receiver to demodulate the signal will depend predominantly on the part of the power of the received data subcarriers, and consequently the energy per bit. However, the data subcarrier power itself cannot be measured by a broadband power measurement because data subcarriers are always combined with pilots. The most powerful and convenient measurements are made using the OFDMA demodulator, because it is capable of isolating the data subcarriers from the pilot subcarriers and measuring their respective power. *Subcarrier power_{Data}* is shown as part of the demodulation result as $DPwr$ in Agilent's VSA and MXA. Typically it will read tens of dB less than the total signal power.

The power on the data burst measured using a power meter or MXA is the sum of the pilots and data subcarriers. In the downlink signal only, this power is related to the preamble, depending on the boosting used for different functions, described later.

Measuring broadband average power provides a traceable route for checking the correct calibration and operation of the transmitter and the performance of the receiver.

4.2.2 Power control

Power control is a mandatory part of ranging on the UL as specified in the *WiMAX Forum Mobile System Profile Release 1.0 Approved Specification* document. There are two modes, closed loop and open loop. In closed loop, the BS emulation instructs the MS to adjust the transmit power via MAC layer commands. The power control is over a 45 db dynamic range and minimum power steps of 1 db, with relative accuracy of ± 0.5 db plus the associated measurement uncertainty on power measurement. The power measurement measures the burst power with appropriate triggering, or uses time gates with the help of tools such as a VSA or wideband power meter as discussed in Section 4.2.3. In open loop, the MS is responsible for setting its own transmit power level, based on calculated link loss and the SNR required at the BS receiver for a specific modulation and coding scheme. The MS changes transmit power immediately with changes in modulation. The MS is required to report to the BS the transmit power it is using. When the burst allocation is defined, this reading should be equivalent of the gated broadband measurement on the UL signal, which is the same as a gated channel power measurement.

4.2.3 Measurement of power

As shown in Section 4.1.1, a WiMAX frame will exhibit different average power levels for different symbols throughout the frame. There are three ways to measure this power: using a power meter, spectrum analyzer, or a VSA. Triggering and measurement gating are required for the power meter and spectrum analyzer.

Mobile WiMAX has channel bandwidths from 3.5 to 10 MHz (potentially 20 MHz in the future). The measurement tool needs to have the required bandwidth, frequency, and dynamic power range to make these measurements. Power meters provide the best absolute accuracy for measuring total power. As seen in the previous section, the burst design needs to be known to relate broadband power to subcarrier power. The second power measurement uses the MXA, with a one button function for channel power in dBm/10 MHz and power spectral density expressed in dBm/Hz.

The measurement capture in demodulation mode with the VSA, as illustrated in Figure 11, shows the time waveform, and time-gated band power in the top trace. The lower trace uses signal demodulation to show the power of pilots, data subcarriers, and in this example, a CDMA burst.

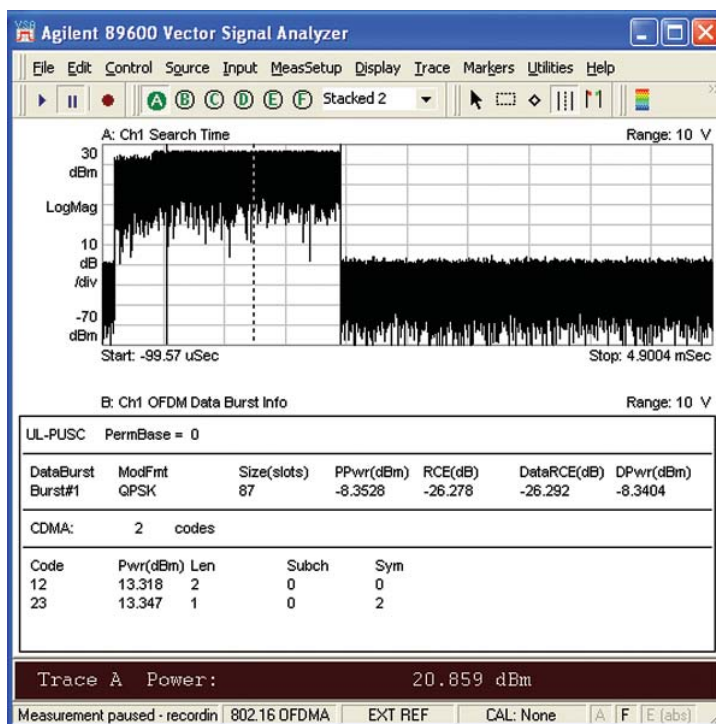

Figure 11. OFDMA burst (UL) with information on pilot power, data subcarrier power, and total power

In the measurement shown in Figure 11 on an UL signal, is a PUSC zone with a QPSK burst. The total power is +20.9 dBm. The power of each pilot subcarrier (PPwr) is -8.3 dBm, as is the power of data subcarriers (DPwr). This is expected, because the pilots are not boosted in the UL. As discussed earlier in Section 4.2.1, the VSA can also provide a total power reading by scaling power of data and pilot subcarriers by the number of data and pilot subcarriers.

We mentioned the differences between UL and DL in Section 4.1.1. Let us now describe power measurement on a DL that has a PUSC zone. This is necessary because we will be discussing receiver measurements on the mobile later in this application note. DL power measurements are a pre-cursor to making receiver measurements.

A DL signal has subcarriers associated with the preamble that occupy one symbol and pilot/data subcarriers associated with data bursts. To make DL power measurements, one can gate over the preamble or other parts of the DL signal and obtain the power. Alternatively, the power can be computed using the power measured from RSSI, pilot subcarrier, and data subcarrier provided by the VSA demodulation measurement. One ratio that is important is that between the preamble power (measured as RSSI) and the combined pilot and data power for a fully allocated burst. This preamble is 3.86 dB higher.

Converting from a gated broadband power measurement of a 10 MHz preamble DL signal to a PUSC zone is simple when using linear power measurements measured in watts. The expression gets a little more complicated if working in dBm. To illustrate this, consider a measurement on a DL PUSC signal using the subcarrier parameters for a 10 MHz wide signal, as shown in Table 6.

Table 6. Downlink and uplink subcarrier parameters for different zone types and FFT sizes. Values in bold are used in the example

| Zone type | PUSC partial usage | |
|--|------------------------------|-----------------------|
| Slot size (symbol groups) | DL: 2 symbol UL: 3 symbol | |
| Bandwidth (MHz) FFT | 5.0, 3.5 512 | 10, 8.75, 7.0 1024 |
| DL preamble subcarriers | 142 | 284 (852/3) |
| DL zone | | |
| Data subcarriers | 360 | 720 |
| Pilot subcarriers | 60 | 120 |
| Sub-channels | 15 | 30 |
| Preamble – full data burst allocation (dB) | 3.86 | 3.86 |
| Total pilot/preamble (dB) | -10.27 | -10.27 |
| Uplink zone | | |
| Data subcarriers | 272 | 560 |
| Pilot subcarriers | 136 | 280 |
| Sub-channels | 17 | 35 |

As described above:

$$\text{Symbol Power}_{(Data + Pilot)} = 10\log \{10^{(Data\ power/10)} + 10^{(Pilot\ power/10)}\}$$

In the DL, subcarrier power is related to the preamble

$$\text{Data Power} = \text{Preamble power (RSSI)} - 19.76^* + 10\log(\text{number of active sub-channels})$$

$$\text{(Boosted) Pilot power} = \text{Preamble power} - 10.27^{**}$$

$$* -19.76 = -10\log(8) - 10\log(852/3) + 10\log[(720+120)/30 \times 720/(720+120)]$$

$$** -10.27 = -10\log(8) - 10\log(852/3) + 10\log(16/9) + 10\log(120)$$

The terms $[10\log(16/9)]$, $[10\log(8)]$ in the calculations above account for the boosting on data and pilot subcarriers. (The values 16/9 and 8 are derived from the IEEE system design document.)

- Data – 0 dB $[10\log(1)]$ (when not boosted)
- Pilot – Boosted by 2.5 dB $[10\log(16/9)]$
- Preamble – Boosted by 9 dB $[10\log(8)]$

Figure 12 illustrates how the subcarriers are used and shows relative amplitudes.

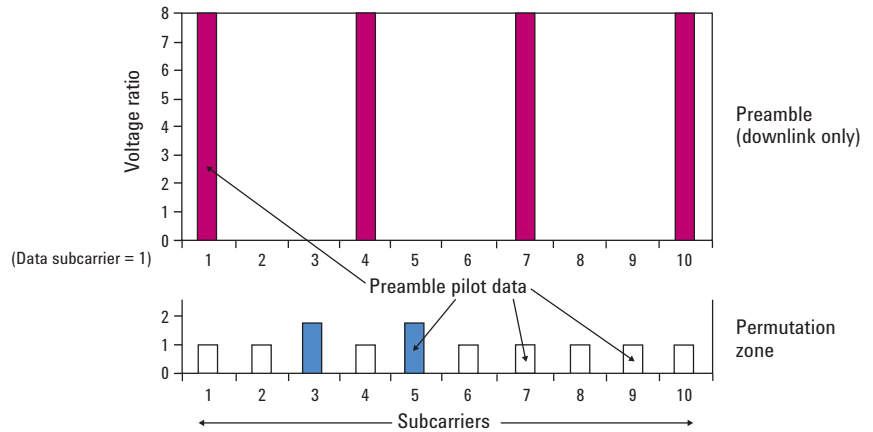

Figure 12. Relative amplitudes of DL subcarriers used for the preamble, data, and pilot

Boosting on data sub-carriers is also allowed in the specification to adjust the power for users that are to close to or far from the BS.

The equations above show how we can verify the correct boosting levels on preamble, data and pilot subcarriers, and how to relate preamble power to data power. This is important because for some tests RSSI (preamble power) is used as the controlled variable and in others it is the power of the user data burst.

For a fixed preamble power, i.e. RSSI reading, Figure 13 shows how the power readings for data with and without pilots increase with the number of sub-channels. As an example, for ten used sub-channels, the total power measured across a symbol will be 7 dB below the preamble power. The ratio of 3.86 dB mentioned earlier can be seen where the bold blue line intersects the right hand axis.

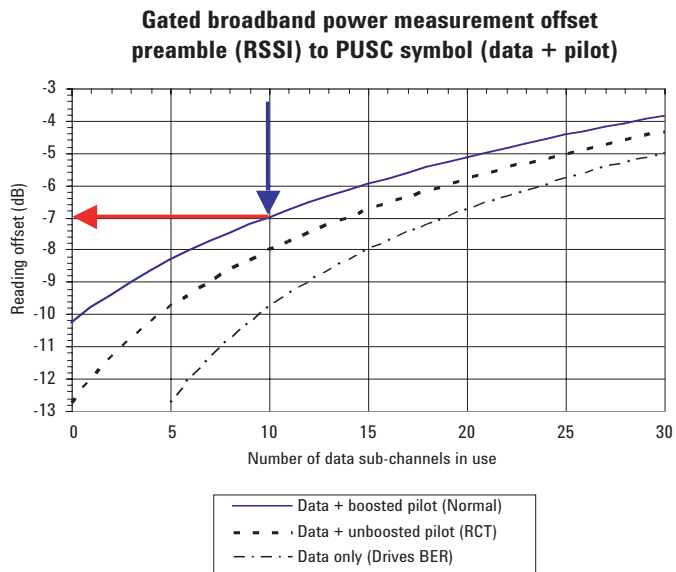

Figure 13. The relationship between the powers measured with a broadband power meter, gated over the DL preamble or a PUSC symbol containing data

CCDF is an important diagnostic measurement for designing WiMAX power amplifiers. The amplifiers must be capable of handling the high PAPR of the OFDMA signal, while maintaining good adjacent channel leakage performance and low EVM.

CCDF shows the distribution of peak-to-average power ratio (PAPR) versus the probability of a particular peak level occurring. Time gating is essential when making CCDF measurements on the OFDMA signal.

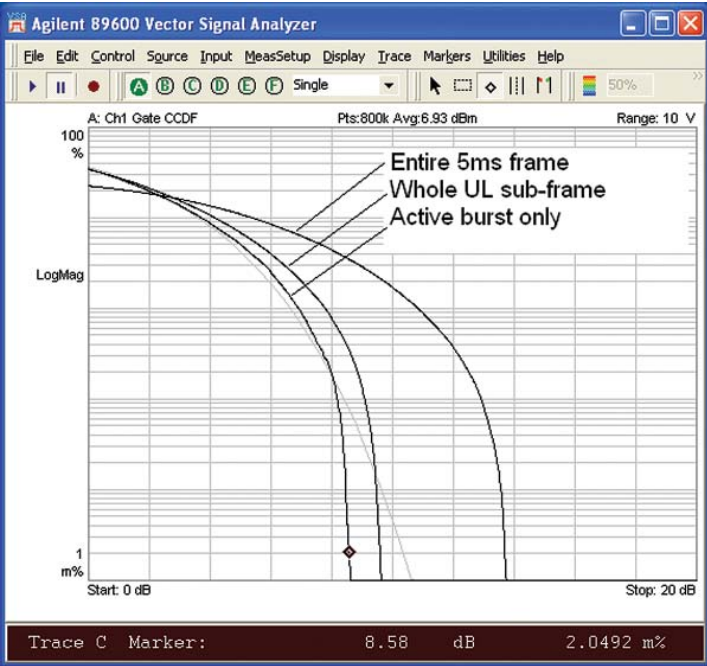

Figure 14. Without the correct gating, the CCDF measurement shows significant variation

The left-hand power reference is automatically set to the average of the measured signal — in this case, 15.6 dBm. By placing a marker on the CCDF plot, the probability that the signal power, indicated by the marker, to be above average power is seen. Figure 14 shows the marker reading on the trace and that the probability the signal power exceeds 7.8 dB above average power is 2.3 percent.

The CCDF plot shows the power distribution of an additive white Gaussian noise (AWGN) in gray as a reference. In OFDM it is representative of the case of multiple uncorrelated carriers with random phase offsets.

With time gate enabled on, CCDF measurements can be obtained for different parts of the frame. Figure 15 shows a gated CCDF measurement on an active part of the UL data burst. For a signal with no distortion, the burst power is expected to stay close to the AWGN curve.

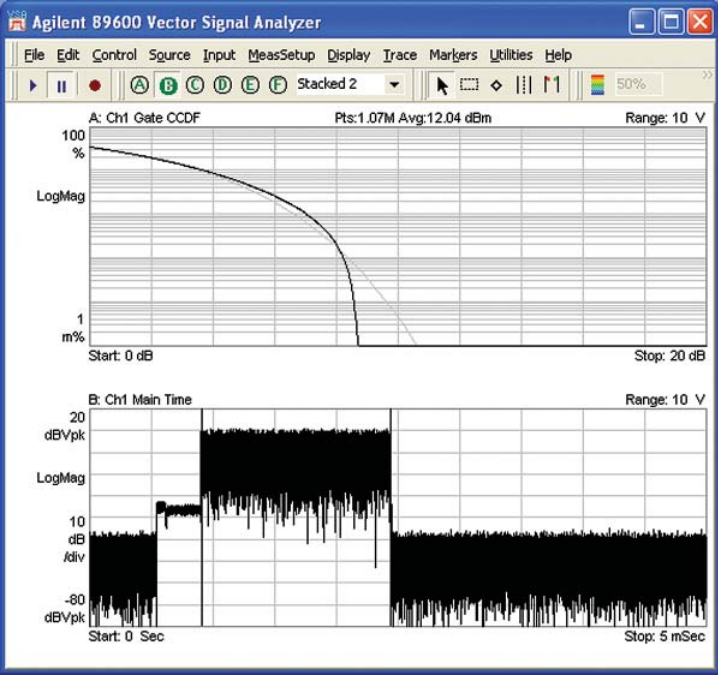

Figure 15. Example of an UL signal with the correct gating, around the active burst

Compression manifests itself as non-linear distortion in the transmitted signal, which cannot be removed by the receiver equalizer. It causes increased EVM (RCE) readings which reflect potential bit errors in the received signal and a reduction of system error margin. It also creates unwanted spectral energy in adjacent bands, which implies interference for other users on different center frequencies. Uniquely in OFDMA, compression also creates in-band spectral energy that results in interference to other users on the same center frequency. This is the motivation for the unmodulated RCE measurement, noted in Section 4.4.3.

Gated CCDF measurements can be performed over the preamble and data parts of a DL signal to gain insights on peak-average ratio.

Note: For more information on WiMAX signal measurements, refer to *Agilent IEEE 802.16e WiMAX OFDMA Signal Measurements and Troubleshooting* application note 1578, literature number 5989-2382EN.

The transmit spectrum is a bursted signal. Like the power measurements described earlier, it needs a trigger to make an accurate measurement. However, it is also possible to make non-triggered measurements, using a sweep time that allows several bursts for each display point, as long as the burst is of a constant shape. When using an average detector on the spectrum analyzer, you should then allow for the on/off ratio using $10 \log [\text{ton}/(\text{ton}+\text{toff})]$ scaling on the power reading. Measurement gating gives more control of the measurement, by performing the analysis only the “on” part of the burst.

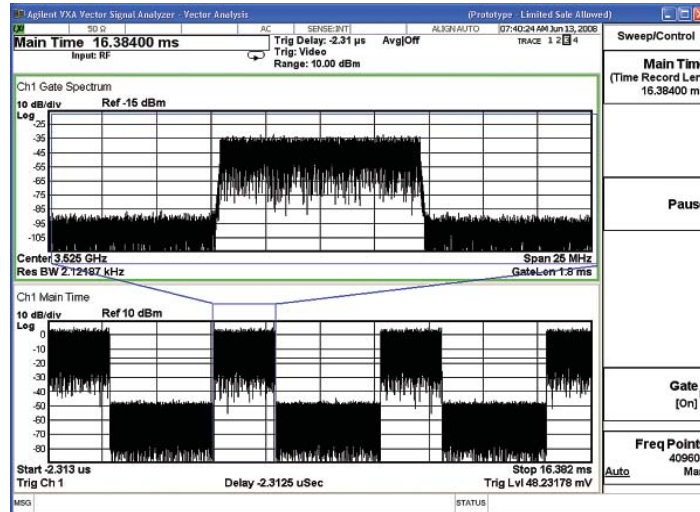

Figure 17. Time gating on an RF burst

For a non-gated measurement, increasing the sweep time will remove the drop out effect of the on/off power levels in the frame. An external trigger gives the most robust triggering. The MXA has a periodic timer to analyze the “on” part of the RF burst, providing accurate measurements with wider spectrum spans (refer to Section 4.1.2.)

4.3.2 SEM

The transmit output spectrum is a place to look for problems exhibited by the radio amplifier approaching saturation or errors in the transmit filter implementation. In Figure 18, the amplifier output power has been increased to the maximum allowable and is recorded as +21 dBm.

IEEE 802.16e defines a spectrum emission mask with the objective of ensuring one user’s signal does not unduly interfere with the operation of other 802.16e wireless devices operating in adjacent frequencies.

Separately, regulatory authorities define different masks, designed in particular to protect the operation of radio users outside the bands being used by the WiMAX signal. For some common frequency bands, the WiMAX Forum has designed limit masks intended to verify that a device will satisfy the performance required of a wide geographical range of regulations.

The measurement is carried out by programming the MS radio to transmit a burst using all available sub-channels for the entire duration. It is a conducted measurement, i.e. an RF cable from the transmitter output is connected to the spectrum analyzer. A conformance measurement should use 100 different bursts.

Figure 18 shows the WiMAX SEM test limits for a 10 MHz signal in the 2.5 to 2.6 GHz band. The signal is at the edge of the test limit at -11.5 MHz. A state file was used to set: the time gating to match the burst duration, offset limits to suit the chosen mask, detector type to average, and sweep times for acceptably small measurement variation. Shorter sweep times increase the measurement update rate, but also increase the variance in the result. In this example, the sweep time for the 11.5 to 15.5 MHz limit was specifically increased.

The gaps in the mask do not mean there are gaps in the signal frequency being tested. They occur because the 1 MHz measurement integration bandwidth is a significant portion of the individual limit bands. The measurement bandwidth extends 500 kHz either side of the mask end point, ensuring complete coverage of signal content.

The signal in the first offset band is approximately 10 dB lower than the one further out because the measurement bandwidth is 100 kHz, not 1 MHz. The single data point at ± 10.5 MHz is caused by the limit band being the same as the 1 MHz measurement integration bandwidth.

In the SEM measurement on the MXA shown in Figure 18, take note of ADC overload or other error messages in the event of insufficient attenuation settings.

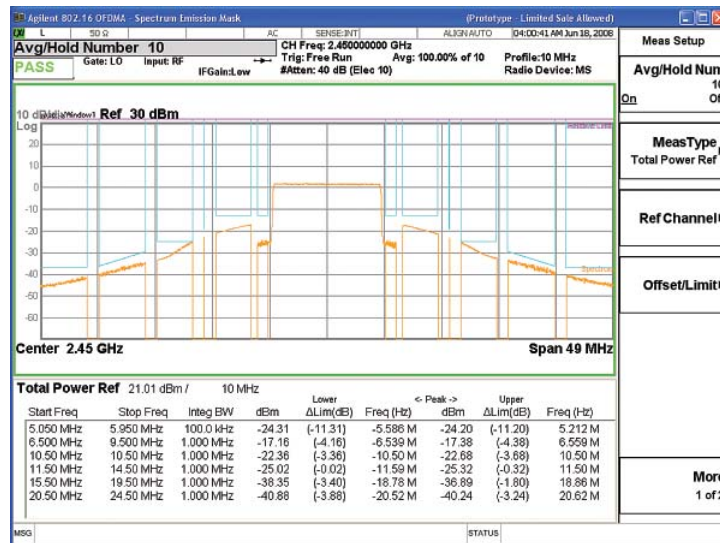

Figure 18. SEM on the MXA using WiMAX Forum 10 MHz mask

4.3.3 Adjacent channel power (ACP)

ACP refers to the power in adjacent transmit channels. As shown in Figure 19 the measurement can be done with the Agilent MXA signal analyzer. The span is set according to the signal bandwidth. Once again, time gating is used to capture the wanted test burst.

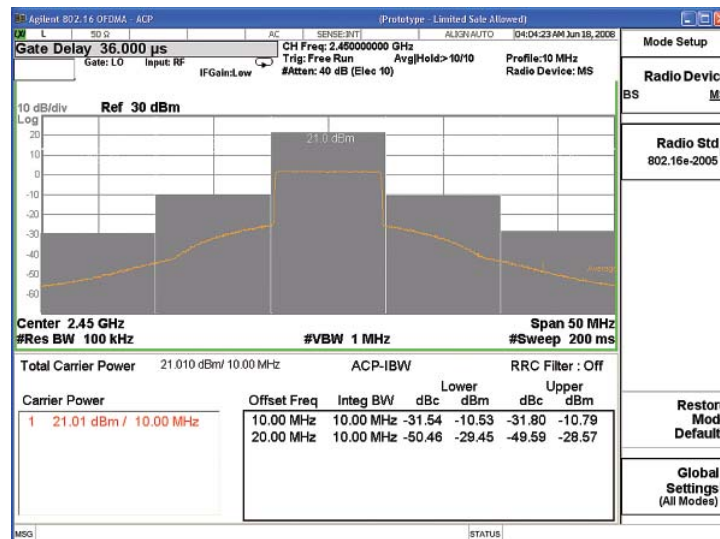

Figure 19. ACP measurement for an 802.16 OFDMA format signal on the MXA

Amplitude distortion is the main cause of high ACP readings. It will also cause an increase in EVM. It has, however, been noted that the two parameters are not totally correlated. Figure 20 shows a typical result when the ACP is plotted against EVM for multiple frames, each with different payload data. Rather than a straight line, for the same ACP (on the vertical axis), some payloads give better EVM than others. This is due to the spectral distribution of distortion components either being in-band or out-of-band.

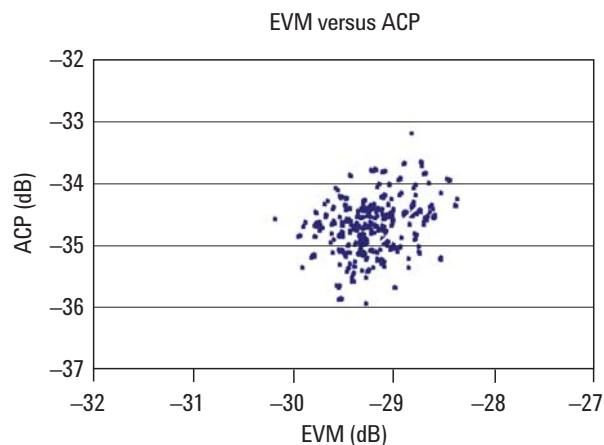

Figure 20. EVM plotted against ACP for a distorted signal with varying payload

4.3.4 Spurious emissions

Spurious emissions outside the transmit band cause interference to wireless devices operating at those frequencies. Regional regulatory authorities dictate the maximum levels allowed, with the spectrum analyzer acting as a “proxy” victim receiver. The WiMAX Forum may also produce a test mask.

The MXA signal analyzer has a feature to conveniently measure and tabulate any spurious responses. In Figure 21, the trace at the top shows the level of spurious with marker readout at 1.94 GHz. The table below lists amplitude of the spur detected at various frequencies and the limits set by the user. Peak detection is generally used as a widely available way to capture the highest level of the spur occurring at specific frequencies. Alternative methods may produce similar results, but are not explored here.

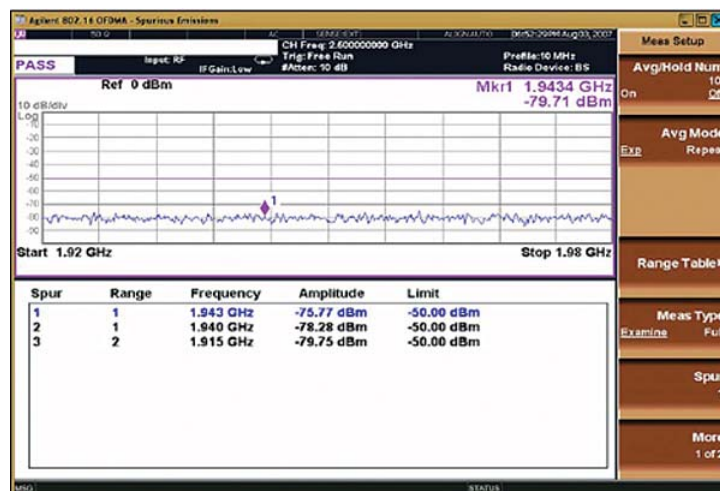

Figure 21. Spurious measurement with the MXA

4.3.5 Spectral flatness

Baseband and RF filtering in the MS hardware mean the frequency response across the signal bandwidth (3.5 to 10 MHz) bandwidth are unlikely to be perfectly flat. IQ imbalance will also affect flatness. If the UL uses a sparse subcarrier allocation with few symbols, distinct jumps can be seen in the display traces.

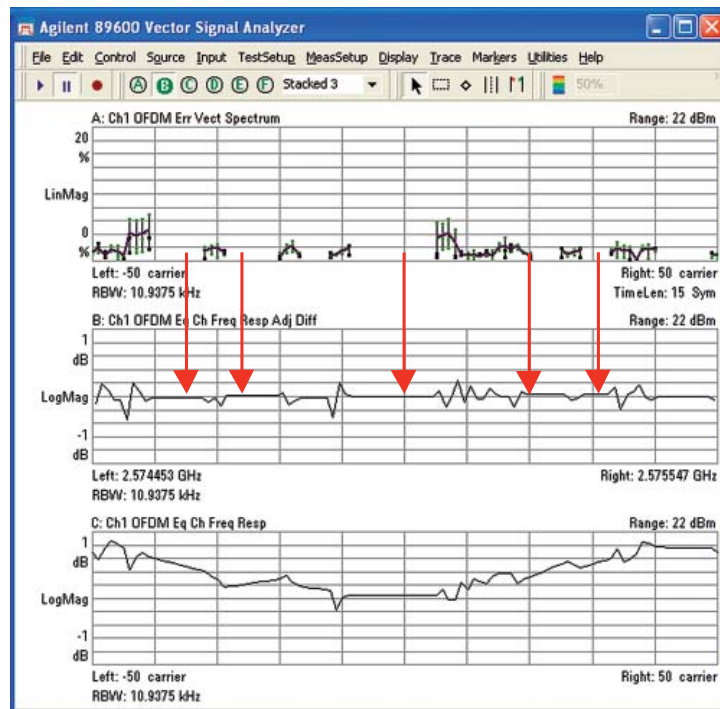

Figure 22. Frequency response of a MS transmitting a PUSC zone with partial sub-channel usage

Figure 22 shows the frequency response (Plot C: Ch1 OFDM Eq Ch Freq Resp) of a MS transmitting a PUSC zone with just 4 sub-channels, 15 symbols long (60 slots), and 10 MHz in bandwidth. Plots A and B show the gaps in subcarrier usage due to the sparse sub-channel occupation. These regions are indicated by arrows.

There are three parts to the flatness measurement. The DC subcarrier 0 needs to be suppressed by 15 dB relative to the total average power of all data and pilot subcarriers. The measurement does not include carriers intentionally power boosted or suppressed. Next, the outer subcarriers need to be within $\pm 2/-4$ dB limits from the average power transmitted by all active subcarriers, and the inner subcarriers need to be within ± 2 dB. Finally, adjacent subcarriers need to be with ± 0.4 dB.

This measurement is carried out on the uplink with the MS transmitting repeatedly across multiple frames. The standard specifies the test conditions under which the power variations are computed. The conditions include minimum and maximum power, different modulation, and zone types. The measurement is averaged over 40 to 60 OFDM symbols to minimize spectral fluctuation due to different modulation patterns.

The flatness measurement is a demodulation measurement. The MXA has this test automated as a one button measurement along with the mask test.

4.4 Modulation tests

If abnormalities are seen in the transmit spectrum, it makes sense to check if the modulator is working as reflected by the EVM measurements. To verify the modulation performance of the mobile, use a BS emulator and establish connection with the MS, or command the MS to transmit a specific burst. A VSA is needed to perform modulation measurements.

4.4.1 Configuring the demodulator for UL measurement

In normal operation, the BS sends the preamble, FCH, DL-MAP, and UL-MAP to instruct the MS how to receive and transmit bursts. The demodulation measurement also needs to be told, or find out, what the UL transmission looks like before it can make the demodulation measurements. Burst information can come from several sources, including a Signal Studio .scp setup file, the MAP file obtained from the DL signal, or using a manually-entered configuration. The Agilent VSA is able to auto detect the UL signal if it is a single burst. When measuring noisy signals, the auto-detection algorithm may not be able to determine the correct data burst modulation type. In such situations, configuring the analyzer to use manually-specified data tone modulation formats, which can be done using the burst profiles in the VSA's demodulation properties, extends the measurement dynamic range.

4.4.2 Burst allocation effects

A new feature associated with the flexibility of OFDMA is that frequently not all the subcarriers are used during the UL transmission from an individual MS. This has a novel impact on the way distortion affects in-band performance. In-band distortion products cause the expected EVM degradation on subcarriers that form part of the wanted signal. Elsewhere, instead of there being no signal power, the distortion acts as interference to other MSs expecting to occupy the first MS's unused subcarrier.

To understand distortion of an OFDMA signal, a comparison can be drawn with a multi-tone signal of uncorrelated tones. If there are no vacant tones, distortion creates inter-modulation products, which are most noticeable as spectral re-growth— affecting the SEM measurement. If some tones are not used, intermodulation distortion will also put spectral energy at the frequency of the unused tones. With the OFDMA signal, variations in the payload data make this interference look like noise.

At a constant transmit power, the level of distortion associated with used and unused subcarriers varies markedly, as shown in Figure 23. The EVM of used subcarriers increases with the sub-channel allocation because progressively more of the distortion components lie on wanted subcarriers. For the unused subcarriers, the reverse is true. When nearly all subcarriers are allocated to the wanted signal, only a small proportion of distortion spectral components fall in unused subcarriers, so the total power drops. When only a few sub-channels are used for the wanted signal, most of the distortion now occupies the unused subcarrier spectrum, resulting in an increase in unused subcarrier EVM (RCE).

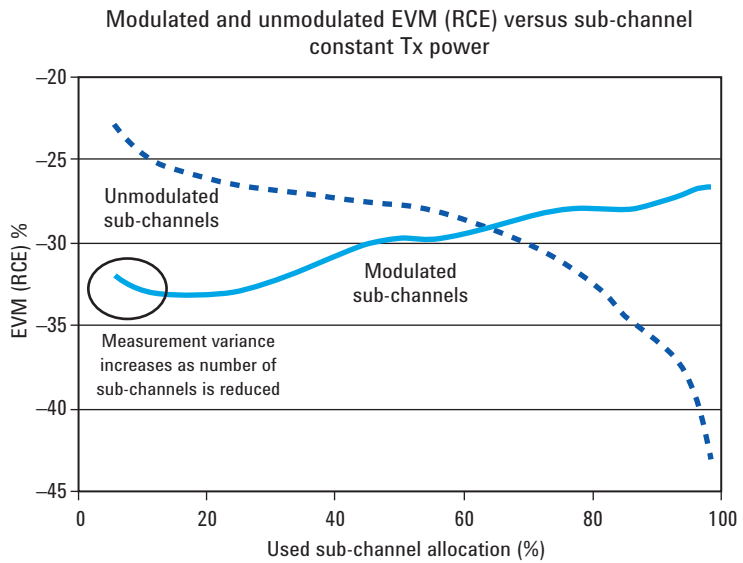

Figure 23. An example of the variation in modulated (solid blue line) and unmodulated (dotted blue line) RCE (EVM) as the sub-channel allocation changes given constant total transmitter power

Figure 23 shows the variation in results for the same transmit power and demonstrates how important it is to know the design of the burst (sub-channels allocation) to achieve repeatable measurements. This explains why the WiMAX Forum is specific about the burst type for performing most tests.

4.4.3 Modulation accuracy RCE (EVM)

The modulation accuracy is the deviation of error vector from a recovered target value; hence it is a relative measurement. As noted above, the measurement is carried out on both modulated and un-modulated carriers to ensure that the MS does not degrade the link for itself or other users. The performance limit is the same for a given output power and modulation. The MRCT document specifies the value for RCE for different burst profiles. The measurement is done with tracking enabled for amplitude, frequency, and timing errors. The equalizer is set to operate on both pilots and data, and remove amplitude, phase, and timing errors, thereby matching the expected capability of a BS receiver.

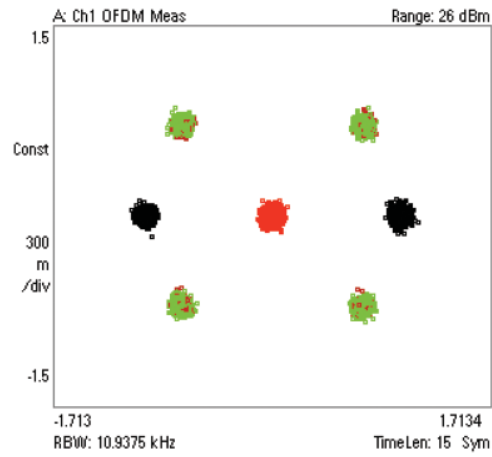

Figure 24. Constellation of an UL signal. The red dot in the center refers to the RCE on the un-modulated carriers. The BPSK pilots are shown in black and the QAM data bursts in green and red

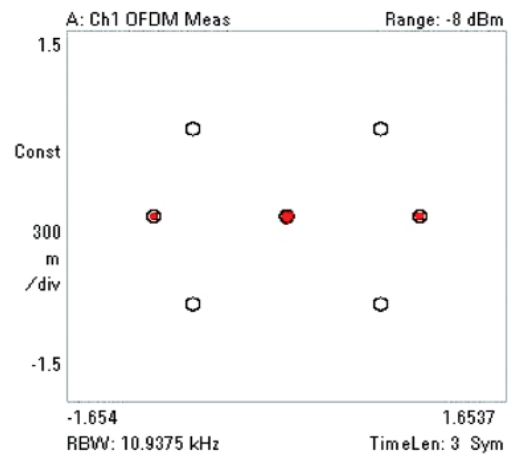

Figure 25. The constellation of the CDMA ranging burst is indicated by the row of red dots in the center. The circles indicate the target EVM. The diameter is user-definable

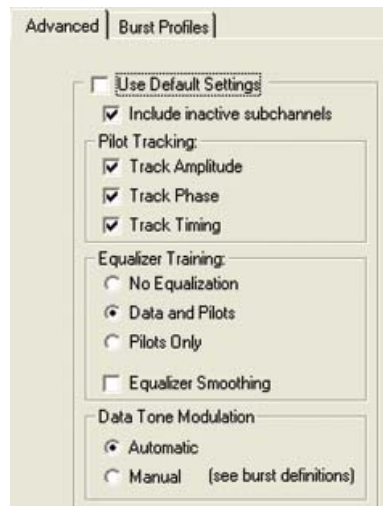

Figure 26. VSA modulation properties dialog box showing settings for pilot tracking and equalizer training

4.4.4 Modulation coding (CTC, CC)

Convolution coding and convolutional turbo code are FEC codes mandated by the WiMAX Forum for use in Mobile WiMAX to ensure robust data transmission. CTC improves data throughput under suitable channel conditions. The downlink interval usage code (DIUC) is the indicator of a burst modulation profile, which can be set in the VSA software under the 802.16 Demodulation Properties tab. Selecting the incorrect profile will prevent the recovery of the UL MAP information from the DL signal.

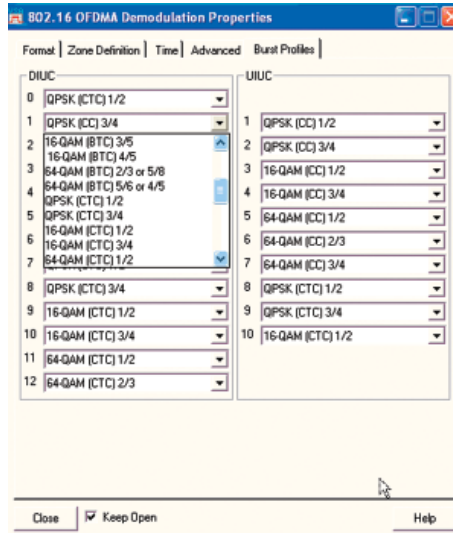

Figure 27. DIUC settings for bursts

4.4.5 Special functions. Testing initial and periodic ranging, HARQ

The standard requires the MS to be able to adjust its transmission according to ranging information sent by the BS. The ranging information includes power adjustment, frequency adjustment, and timing adjustment. This initial ranging procedure enables the MS to obtain frequency synchronization within a specified tolerance with the BS. The MS will not attempt uplink transmission until it obtains synchronization. During normal operation, the MS keeps track of frequency changes in the BS through periodic ranging and it will defer transmission when synchronization is lost. The E6651A provides the mechanisms for testing ranging operation, with logging of associated messages such as RNG-REQ and RNG-RSP.

HARQ functionality, in which the receiver asks the transmitter for retransmission of the lost or incorrectly received packet of the mobile, can also be tested with the E6651A. Figure 28 shows an example of how the E6651A test set provides this emulation.



Figure 28. HARQ measurement as emulated using the E6651A test set

4.5 Frequency and timing tests

4.5.1 Power versus time (PvT)

This measurement requires the instrument to have an instantaneous (not swept) bandwidth at least as wide as the signal, and examines the time domain burst shape of the signal and rise and fall edges of the power envelope.

Although the 802.16e-2005 standard does not define any conformance test for the power versus time mask, a pass/fail limit mask test is commonly used to make sure DSP and RF switching occur at the right time. With wideband signals, the impact of amplitude switching transients on the spectrum may be less noticeable than on narrow band signals such as GSM. This is because the signal bandwidths are comparable to the inverse of the rise and fall times. However, it is still important to make sure PvT is within reasonable limits to avoid unexpected interoperability problems with receivers from different suppliers.

The RTG/TTG measurement (refer to Section 4.5.5) indirectly tests the signal, but the PvT measurement helps identify other issues. As the arrows in Figure 29 indicate, the PvT measurement shows the multiple stages during the start of a burst and a short period after turn-on, when there is no data transmission. In this example, there are two steps in the turn on process, with a clear amplitude overshoot at the start of the unmodulated second step. When superimposed on the first transmitted symbol, it will give an amplitude tracking problem to the BS receiver.

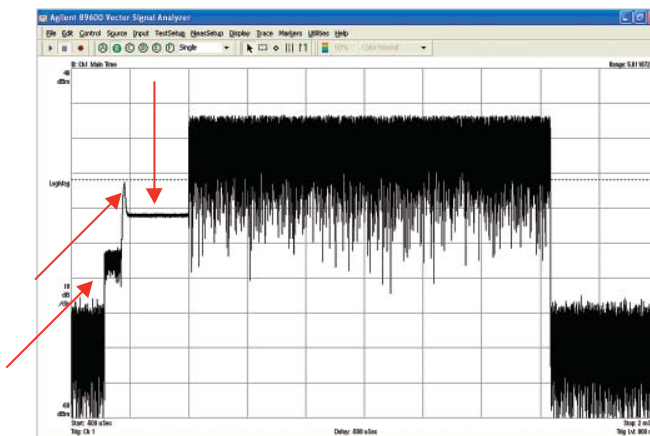

Figure 29. Burst from a mobile showing several stages during turn on (start of the burst) measured on the VSA

The MXA has useful features in the PvT measurement. The burst detection parameters will help automatically search for the bursted signal. If the signal needs to be verified against an external timing source, the burst auto detection function can be disabled in the MXA. In addition, the burst detection algorithm searches a burst from the beginning of the captured data and picks up the first one that satisfies the algorithm. For example, if there are two valid bursts in the captured data, the second burst will be disregarded. As for WiMAX OFDMA, the captured TDD signal could contain both downlink and uplink bursts. In this case, use an external trigger with an appropriate trigger delay so that the downlink or uplink burst comes to the beginning of the captured data selectively.

4.5.2 Spectrogram testing

A spectrogram shows the way spectrum is used throughout the WiMAX frame. WiMAX signals have distinct spectral patterns dependant on the zone type and burst allocations. Spectrograms allow pattern matching for rapid recognition or assessment of incorrectly configured signals.

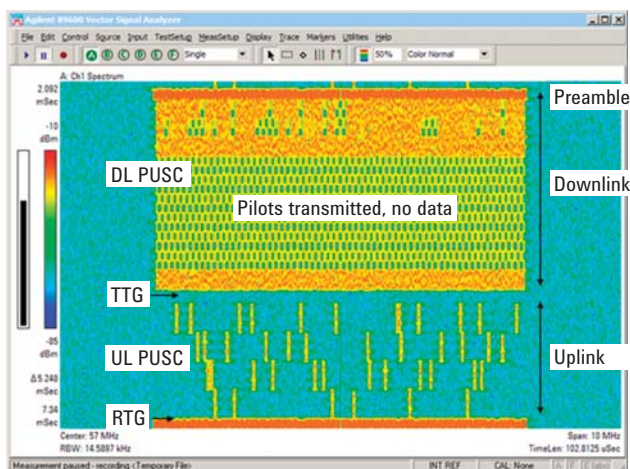

Figure 30. Spectrogram annotated to show UL and DL, TTG/RTG, and zones

A spectrogram displays spectral energy (horizontal) versus time (vertical). Using a signal that has been captured (recorded) it shows spectrum use and the presence of any outside interference in the band with red being the highest power and blue being the lowest. The FFT Overlap ratio, set in percentages in <Max Overlap (Avg Off)>, determines the total time for the vertical scale. Increasing the overlap “slows down” the speed the signal is replayed.

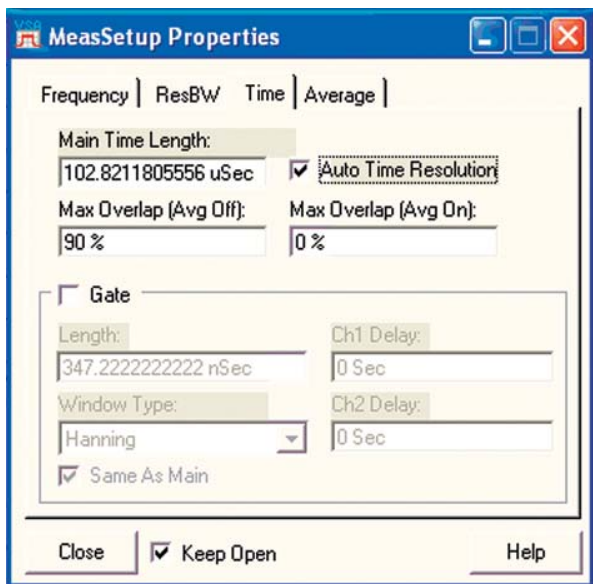

Figure 31. Setting the spectrogram measurement properties. The main time length should be set to match the OFDMA symbol period. Using a Hanning ResBW filter give good resolution of individual frequency components

4.5.3 Frequency errors

As mentioned earlier, the MS needs to adjust its transmission as per the ranging code from the BS. The transmit center frequency should be within ± 2 percent of the subcarrier spacing compared to the BS center frequency. With a subcarrier spacing of the order of 10 kHz, this means transmit frequency errors of less than 200 Hz.

Figure 32 shows an occupied bandwidth measurement on the MXA for a 10 MHz signal that includes a transmit frequency error reading. The measurement in this mode is not demodulating the signal. It is intended as a simple way to indicate if there is any mistuning, or if the signal bandwidth is not what was expected. The measurement requires the burst to occupy all sub-channels over a 12-symbol period or longer. The sweep time should be made long enough to reduce the result variation to an acceptable level.

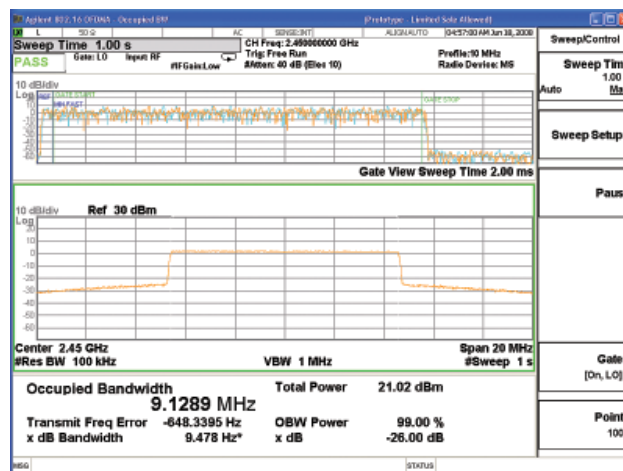

Figure 32. Frequency error reported along with occupied bandwidth measurement on MXA

A more precise frequency error measurement is available using the OFDMA demodulator. It is available in both the MXA OFDMA and 89600 VSA applications. As shown in Figure 33, in the latter, it is reported along with the modulation measurements.

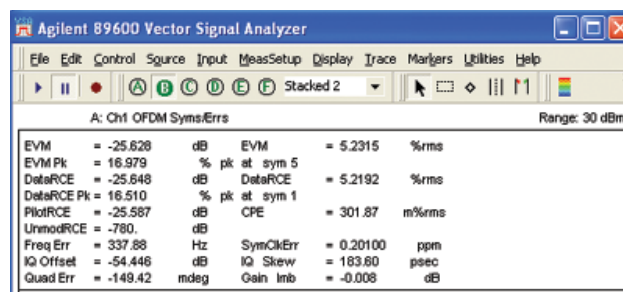

Figure 33. Frequency error reported along with modulation measurements

4.5.4 Transmitter reference timing

The MS and serving BS need to be synchronized in time and frequency so that the signals from all the MSs in the network arrive at the same time at the BS antenna port to avoid intersymbol interference. The transmitter needs to adjust its timing as well, as commanded by the BS, which provides target timing uncertainty as stated in the MRCT document. To verify this synchronization performance, a timing test can be performed using the Agilent E6651A test set.

4.5.5 MS receive to transmit transition gap (MSRTG) and MS transmit to receive transition gap (MSTTG)

In TDD operation, the downlink and uplink transmissions share the same frequency, but are separated by a gap that is an integral multiple of physical slots, as noted in Table 2. These gaps allow both the BS and MS to switch from receive/transmit mode to transmit/receive mode. The transitions are important to check for problem areas that affect normal operation such as amplitude and phase transients in RF control circuits and RF/BB timing alignment. The MS certification test is designed to ensure the last symbol of the DL is received by the MS and the first symbol and last transmitted signals from the MS have an acceptable modulation error. Symbol-by-symbol results are measured in both MXA and 89600 VSA.

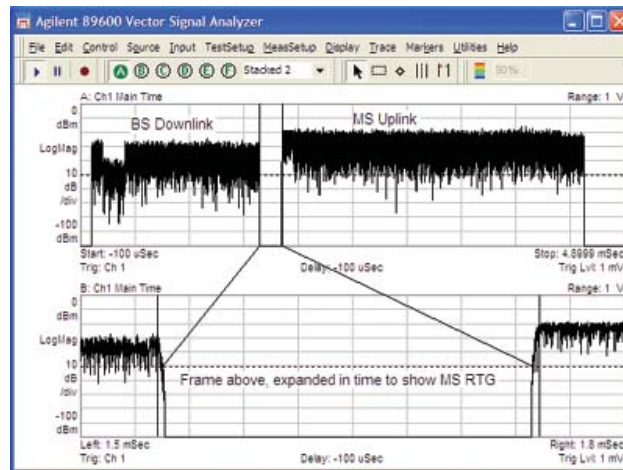

Figure 34. WiMAX TDD burst showing the last symbol of the DL and the first symbol of the UL

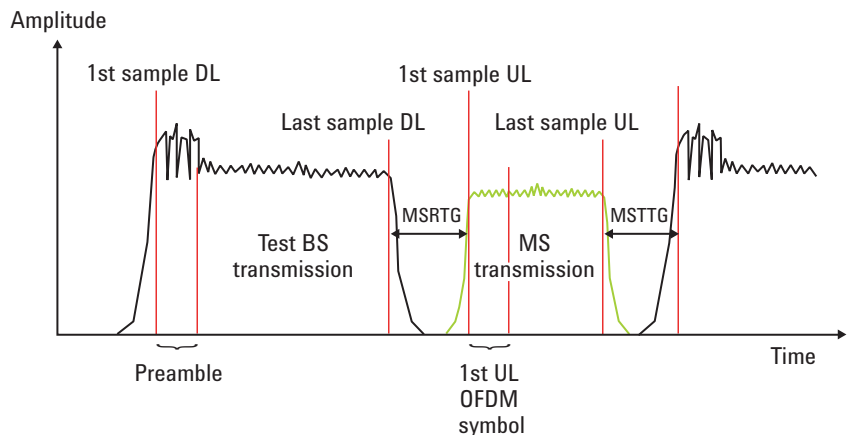

Figure 35. RTG/TTG as defined by the WiMAX Forum

The MSRTG and MSTTG measurements test both the receiver and transmitter in the MS. The test is carried out using a BS emulator to instruct the MS to send and receive data at fixed positions in the frame, over a duration of 100 bursts. RCE measurements are made on the first and last symbols of the UL transmission. It is recommended that a normal data burst is used to test the first symbol using eight or more sub-channels to reduce measurement uncertainty. A PER measurement is made using the MS's receiver to ensure it successfully recovers both the earliest and latest symbol data in the DL signal.

5. Receiver Measurements

Testing the WiMAX receiver is a series of complex steps spanning simulation, hardware evaluation, and functional tests of the higher-level feedback mechanisms needed for successful operation in a high mobility network.

The receiver in the MS includes the down conversion from RF to baseband, filtering, and demodulation to recover the transmitted data and pilot tones, and provide the management messages to the transmit section for communication with the BS receiver. The receiver needs to work in a harsh environment where the channel is changing continuously and be able to reject interfering signals in adjacent and non-adjacent bands.

WiMAX designs typically use two receivers for diversity, increased throughput, or a combination of the two. This section discusses the configuration of the DL test signals and the measurement setups needed for testing various aspects of receiver performance. The section is written with an emphasis on the use of Signal Studio, but many of the comments apply to testing when using the E6651A Mobile WiMAX test set.

The tests described in this section are based on the requirements specified in IEEE802.16 section 8.4.13, although these lack clarity. Additional implementation details for conformance tests are available in the WiMAX Forum MRCT document.

Both the N7615B Signal Studio and the E6651A Mobile WiMAX test set can be used for receiver testing. The E6651A is intended for testing complete radios, whereas Signal Studio is intended for software and hardware component development and test. Signal Studio can also be used for manufacturing test.

Table 7. Summary of signal generator and BS emulator receiver test capability

| | PER, RSSI, CINR | Function test | Impairments | MIMO | Channel fading |
|-------------------------------------|--|---------------|--|------|--------------------|
| Signal Studio N7615B | Yes, reported using external test software | | IQ errors AWGN Phase noise (MXG) | Yes | Yes, ARB based |
| E6651A Mobile WiMAX test set | Yes, reported by instrument | HARQ | | Yes | External, IQ or RF |

5.1 Test conditions and setup

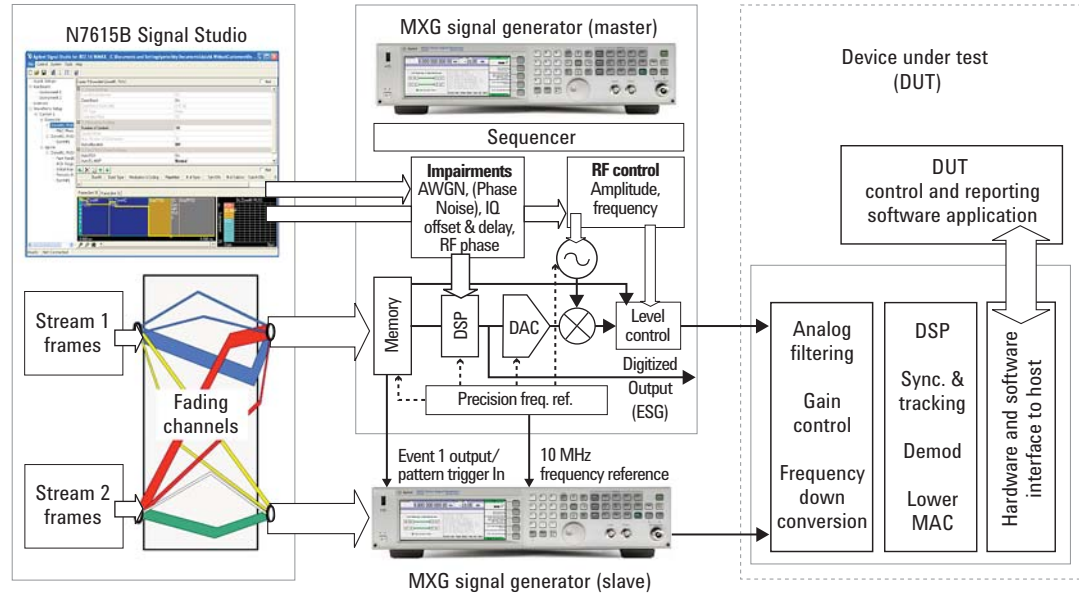

Figure 36. System test configuration using signal generators

Figure 36 shows the general configuration for testing a WiMAX dual receiver using signal generators. The simplified schematic of the signal generator shows the main blocks of signal generation, including the addition of impairments. If a signal generator is used, the output can be fed via a power splitter to both receiver inputs. The WiMAX MRCT document in Appendix 2 describes how to adjust test methods for a maximum ratio combining receivers.

The Signal Studio application creates and downloads the IQ (ARB) waveforms to the signal generation hardware, which it also configures. Once downloaded, waveforms can be stored within signal generator memory, and built into more complex test sequences.

Configuration of the downlink signal needed for testing the MS receivers encompasses the following major parameters.

5.1.1 Power

The fundamental parameter that determines receiver performance is the power per data subcarrier in the OFDMA signal. However, the signal has to be demodulated to measure this value. Most practical tests refer either to the power of the downlink preamble or the broadband power during the data bursts.

$$\text{Power per unboosted subcarrier} = \text{RSSI} - 10\log(8) - 10\log(\text{number of preamble subcarriers})$$

The default power setting for the E6651A test set is based on the total preamble power. It corresponds to the RSSI report from the MS. Using the preamble for power setting gives a defined relationship (shown in the power per unboosted subcarrier equation), between the front panel setting and the power for each data bearing subcarrier. (For further details see the transmitter power measurement in Section 4.2. and receiver sensitivity in Section 5.3.) Signal Studio uses the highest signal power for level control. Unless zone boosting is applied, this means it too will use the preamble, although the setting can be manually over-written.

It is possible to change the power setting to use the data part of the sub-frame, as represented by the colored regions shown in Figure 37. The RF level will then be set according to the type of zone and amount of data subcarriers being used.

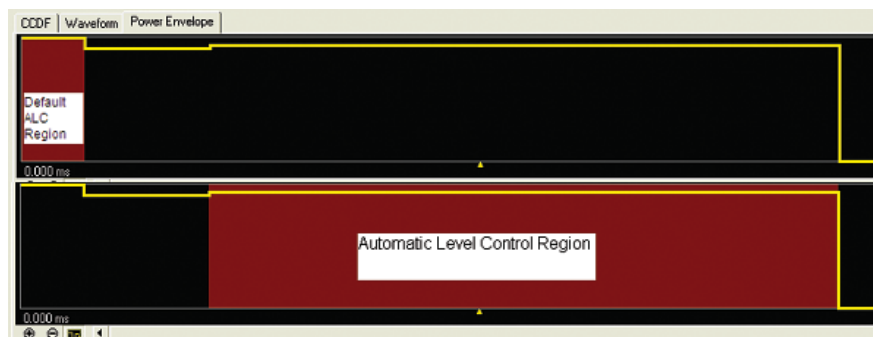

Figure 37. Selection of alternative automatic level control regions in Signal Studio

When using the E4438C, the response time to level changes will be improved if the ALC bandwidth is increased, or the ALC is turned off and RMS Power search used.

When testing MIMO devices using a pair of signal generators, the slave generator power setting is usually lower than the master. This is because the average power for the MIMO zone is calculated and used for automatic level control in the slave generator. The power level is shown on the display readout available in the front panel of the signal generator.

5.1.2 Power boosting

It is possible for the BS to boost the power of individual data bursts or the entire zone. For most testing, the power boost is set to 0 dB, although reducing the power for an individual data burst allows PER tests that focus on the ability of the receiver to recover the burst rather than the MAPs or FCH.

5.1.3 Carrier

More than one carrier can be created when a single generator is used, allowing PER, RSSI, and CINR tests to be run in the presence of an interferer. Typically, the additional carrier(s) will be set to use different preamble indices. A 40 dB difference in carrier level can be achieved by offsetting the wanted carrier by +20 dB, and the interferer by -20 dB.

5.1.4 Number of frames

Conformance testing generally uses continuously changing data and incrementing frame numbers. The E6651A provides this type of signal as part of the BS emulation function. Signal Studio can increment frames for as long as the ARB memory allows.

For basic performance tests in an AWGN channel, a test signal with a small number of frames is quick to generate in the Signal Studio waveform. The results are repeatable because demodulation errors are induced by noise that is uncorrelated to the wanted signal, and averages out over a small number of frames.

5.1.5 Preamble Index

The range for the preamble index is 0 to 113. The actual value may not be important (it is specified for conformance testing), but for manually configured demodulation tests, it is essential to ensure there is a match between source and receiver. The default for a number of tests is four.

5.1.6 Zone type

The most significant choice is between PUSC, FUSC, and AMC. Zones can also be defined as SISO, STC, and MIMO (spatial multiplexing). For SISO zones, the different zone types use different pilot to data subcarrier ratios, which will have a corresponding impact on receiver performance tests. For example, the PUSC DL zone uses one in seven subcarriers for pilots, while AMC uses one in nine. More significant performance variations between zone types will be seen when faded channels are applied.

5.1.7 MAP type

The setting that is chosen, compressed or normal, is determined by the receiver or analysis software capability. Compressed MAPs are more likely to represent real-world signals.

5.1.8 MCS

For a given coding rate, the receiver performance in an AWGN channel degrades by approximately 5.5 dB as the modulation is changed from QPSK to 16QAM, and then again to 64QAM. Normally tests are run with all modulation formats. With AWGN, the performance from one to another should be quite predictable.

5.1.9 Repetitions, coding CC/CTC

Most performance tests are carried out on data bursts, which are not repeated. An improvement of a few dB in the PER performance is expected when switching from CC to CTC. The number of slots used changes linearly with the coding rate. For example, a QPSK burst rate of $\frac{1}{2}$ that uses 169 slots, takes 113 slots at the rate of $\frac{2}{3}$.

5.1.10 Payload

The IEEE specification refers to sequence patterns. These can be selected in Signal Studio. They apply mainly to bit error rate (BER) testing, rather than PER testing. The scrambling mechanisms used to create the final signal tend to isolate receiver performance from the payload, but longer PN sequences give a wider spread in the precise form of the test signal.

5.1.11 Burst design

With the payload, zone, modulation, and coding decided, the burst shape needs to be defined. This is partly for repeatability. Bursts over longer periods will tend to give a worse PER than short ones, especially with high-speed fading. A defined burst shape also allows the power per data subcarrier to be related more readily to measurable parameters. Two ways to define the burst shape are 1) perform base calculations on the preamble or, 2) define the test signal to have all the subcarriers active. The conformance test uses the latter approach, but if the preamble power is correctly set, it is not essential to use the filler bursts shown in Figure 38. Simple rectangular bursts will suffice.

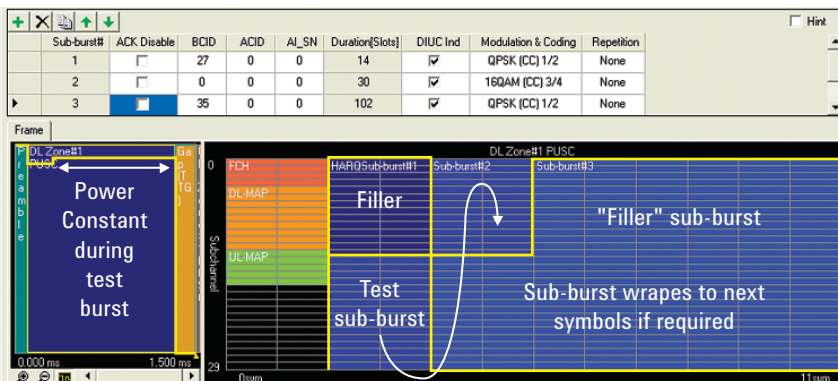

Figure 38. Example of burst design for HARQ based sensitivity tests. Sub-burst 2 is the (16QAM) test burst. Sub-bursts 1 and 3 are QPSK fillers

Although HARQ retransmissions are not used during sensitivity tests, the HARQ ACK/NACK mechanism may be. The IEEE reference Section 8.4.5.3.21 is used as a reference for HARQ burst design. As shown in Figure 38, the first two symbols of the DL signal are used for FCH and MAPs. The test burst may start at a sub-channel offset. It continues to fill up sub-channels as required, and is followed by another sub-burst to make the whole burst use all the available sub-channels (giving an overall rectangular shape).

5.1.12 Carrier-to-noise ratio

AWGN is one of the basic impairments that can be applied to the waveform. As shown in the signal generation block diagram of Figure 36, and accessed under the Instrument settings in Signal Studio, phase noise is added separately to the ARB waveform generation, giving a continuously varying addition to the signal. When selected, the signal generator's broadband noise is present both when the burst is on and off.

Note: Phase noise is an important impairment for OFDM testing, which affects pilot tracking and constellation error. It may be added and controlled directly using the MXG front panel. For the same level of phase noise, -80 dBc/Hz, the EVM of a test signal rose from -35 to -26 dB as the f_2 setting in Figure 39 was increased from 10 to 100 kHz. It is likely to be a contributing, rather than dominant, factor in PER measurement.

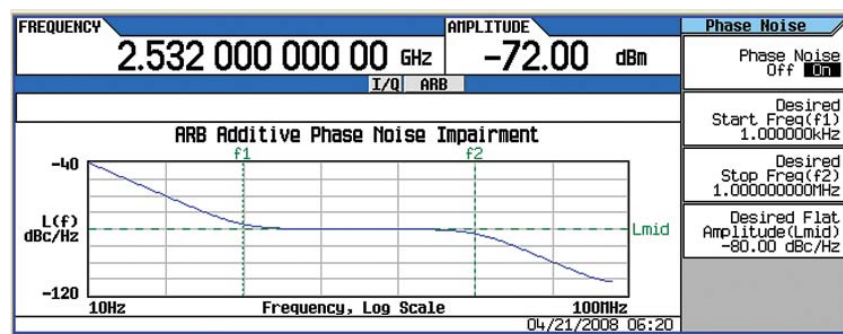

Figure 39. Example of phase noise configuration in MXG signal generator

5.1.13 Channel

For performance testing of RF or other hardware components, a simple static channel is usually sufficient. To test the receiver demodulator, it is necessary to introduce some form of channel emulation. Figure 40 shows how this can be achieved with Signal Studio. When set manually, the random seed value lets you pick different times throughout a long fade.

For receiver diversity testing, the power versus time traces in Figure 40 give an example of how two outputs can be created even from a SISO signal.

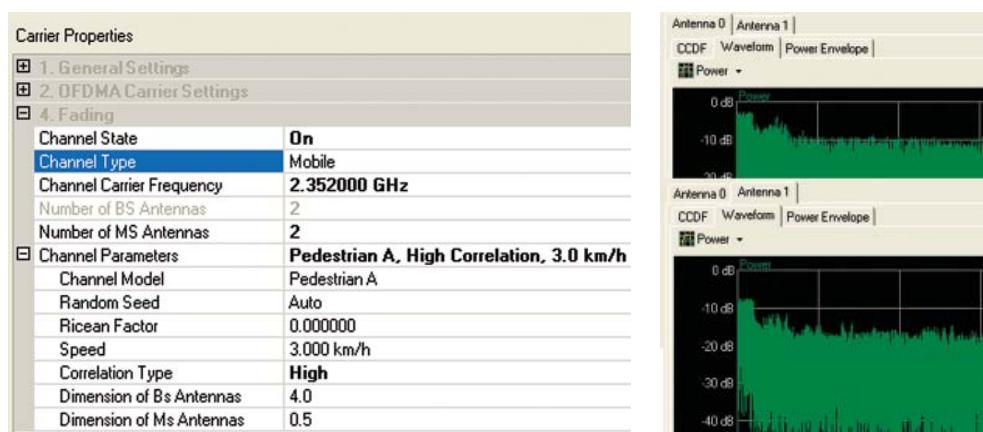

Figure 40. Example of channel applied for SISO transmission into dual channel receiver

5.1.14 Pedestrian and vehicular fading profiles

MIMO and fading channels are required for a number of tests. Figure 41 shows an example of the instantaneous frequency and amplitude response of a Vehicular A 120 km/h test signal. The variations in amplitude can be seen in the bottom trace, while the change in frequency response from the start to the end of the frame can be seen in the upper and middle gated spectrum responses. This gives an idea of the complexity of the signal the pilot tracking needs to tackle, and illustrates why there can be differences in the PER performance depending on the duration of the test data burst.

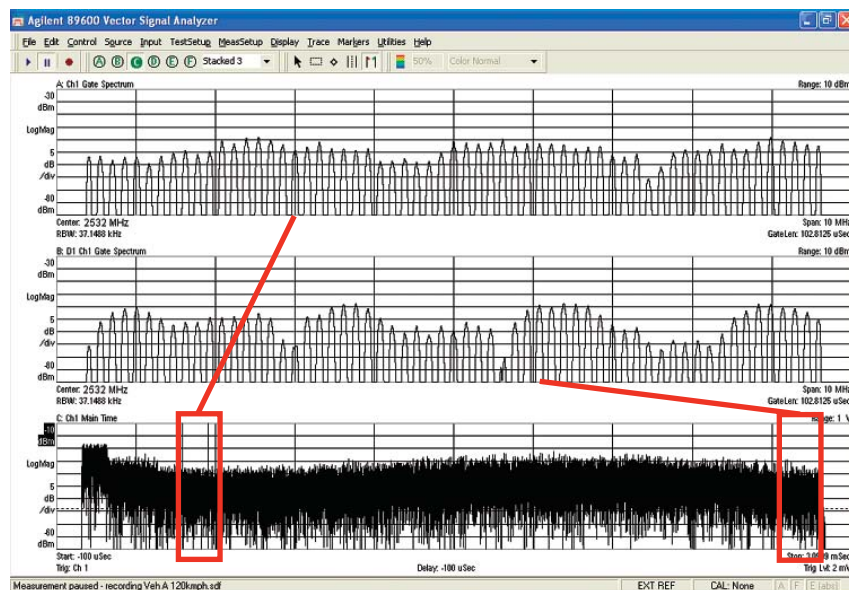

Figure 41. A pilot only signal used to show the variation in frequency and amplitude responses during a single downlink frame with Vehicular A 120 km/h channel

5.1.15 Fading statistics

The fading statistics generated by Signal Studio have been evaluated to assess how closely they match the ideal Rayleigh fading statistics in terms of the cumulative distribution function (CDF) and level crossing rate (LCR). For vehicular fading scenarios with a speed of 60 km/h or faster, a 64 M sample fading simulation from Signal Studio has statistics that closely match the Rayleigh statistics, indicating that this would give similar results compared to a real-time fader. For more slowly fading channels, the random seed value can be changed to jump between different points in a longer fading profile.

5.1.16 MIMO channels

With a 2x2 MIMO channel system, the vector combination of all four frequency responses combine to determine the channel condition number, which is the metric governing the available increase in capacity. A condition number of one, representing 0 dB, indicates a perfect MIMO channel.

Note: For more details on condition numbers, refer to *Agilent IEEE 802.16e WiMAX OFDMA Signal Measurements and Troubleshooting*, application note AN 1578, literature number 5989-2382EN.

Figure 42 gives an indication of how the frequency responses and channel condition number change from frame to frame with a Pedestrian B channel. It is not possible to visually interpolate the expected performance just from the frequency amplitude responses, although simple static amplitude errors between channels will cause a direct worsening of the condition number, and hence the PER in the presence of noise or interference.

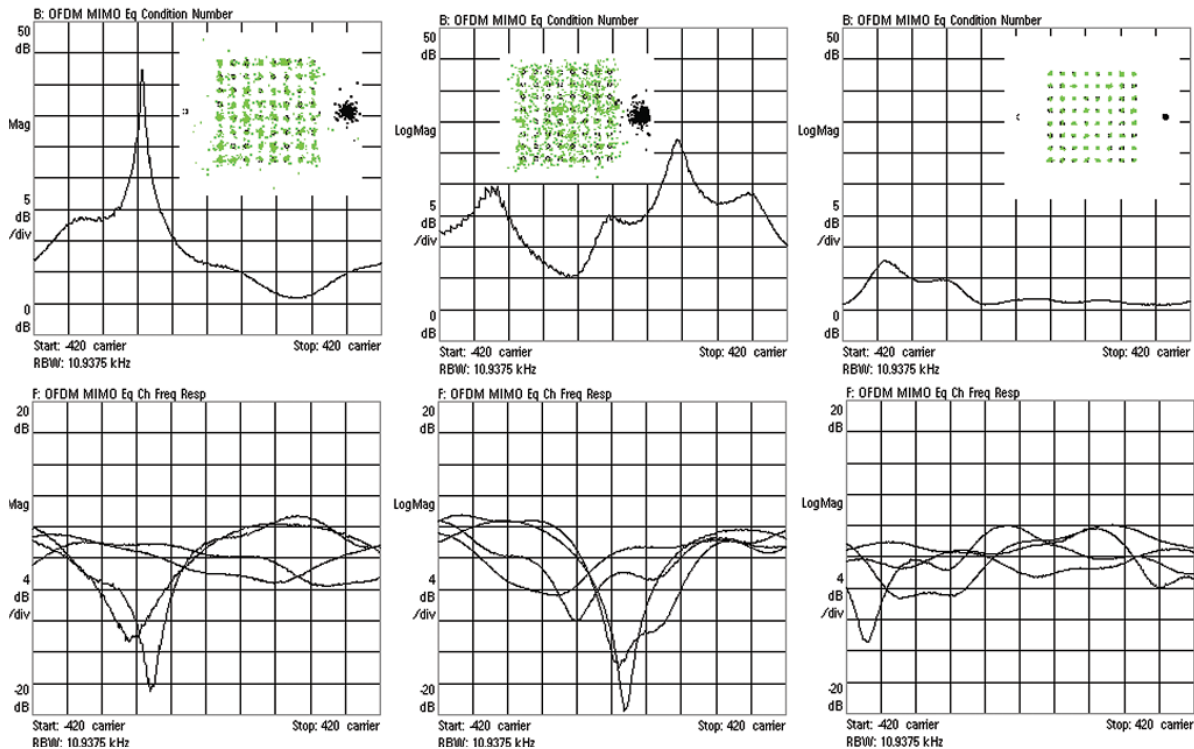

Figure 42. Example of variation of 2x2 MIMO channel responses (lower traces) and matrix condition number (upper traces)

The constellations superimposed on the upper plots of Figure 42 show how varying the condition number impacts the demodulator's ability to recover an individual MIMO data stream. The average condition number of the rightmost plot is lowest, which is reflected in the best constellation performance.

5.1.17 Static channels

Static channels are not part of conformance testing. However, for more advanced users, static channels are an alternative to random number-based fading models and static coupling can be added to test MIMO performance. The coupling coefficients can be adjusted in delay, level, and phase to provide simple approximations to faded channel conditions. It is only meaningful when noise is present. In Figure 43, the user interface settings for channels H01 and H10 shows the delays used to create the condition number response of the lower right trace.

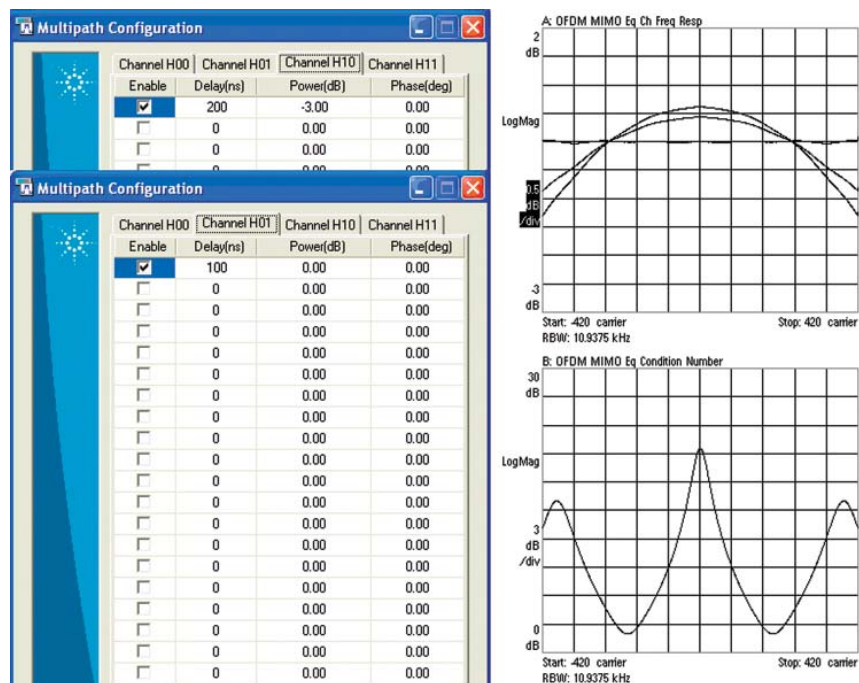

Figure 43. Example of how static coupling with delay can give defined test signal for checking basic MIMO recovery (in noise)

5.2 Maximum input level and maximum tolerable level

The hardware configuration is the same for both tests.

5.2.1 Maximum input level

The purpose of this test is to verify that the MS is capable of decoding an on-channel input signal at the maximum required power level. A connection is established at -30 dBm with a non-robust modulation and coding scheme (64QAM $\frac{3}{4}$ rate coding). The PER test result should be better than 0.49 percent. The test signal is not clearly defined, but it would be reasonable to use the same burst design as that specified for the equivalent sensitivity test.

5.2.2 Maximum tolerable level

This test checks if the MS can continue to operate after the application of a moderately high, 0 dBm, input signal. It is intended as a survivability test to verify that a MS can tolerate the maximum required input level with no damage. Except in exceptional circumstances, this test is unlikely to fail.

The PER is first checked at the sensitivity level, with a QPSK signal. Next, the power, measured for this step using the preamble, is increased to 0 dBm. After 60 seconds, the power is reduced to the sensitivity level, and PER is measured again. If the measured values for PER are okay, the test has passed.

5.3 Receiver sensitivity

The IEEE reference for receiver sensitivity is 8.4.13.1.1. Table 8 summarizes the main test features for IEEE and WiMAX tests. Device performance requirements are based on the assumption of a 5 dB implementation loss and a noise figure of 8 dB. The IEEE document refers to CC coding rather than CTC. The SNR required for CC signals are several dB higher than for the equivalent performance using CTC. The IEEE document only considers the power of data subcarriers, while the MRCT incorporates the presence of pilots.

Table 8. IEEE and WiMAX receiver sensitivity tests features

| | Parameter | Test limit | Payload | Impairments |
|---------------|---------------------|--------------|---|--|
| IEEE | BER (CC signal) | 1E-6 | "S" data sequences of 288, 864, and 1536 bytes | AWGN |
| WiMAX MRCT | PER (CTC signal) | ~0.5% 10% | IP data of 540 bytes IP data of 48-60 bytes depending on MCS | AWGN Faded channels: Vehicular A Pedestrian B |

The equation used for defining the required sensitivity levels with an AWGN channel is:

$$Rx \text{ sensitivity} = -114 + SNR - 10\log R + 10\log (Fs \times Nused/Nfft) + Imp \text{ Loss} + NF$$

Where:

Rx sensitivity is the power of the **data subcarriers only**

SNR is in a range of 5 to 20 dB, depending on the modulation and coding rate

R is the number of data repetitions

F_s is the OFDM sampling frequency (11.2 MHz for a 10 MHz bandwidth signal)

N_{used} is the number of data subcarriers being used

N_{fft} is 512 or 1024 depending on bandwidth

Implementation Loss allowed is 5 dB

Noise Figure assumed is 8 dB

For example with QPSK 1/2, using the IEEE assumptions and a 10 MHz PUSC signal,

$$Rx \text{ sensitivity} = -114 + 5 - 10\log (1) + 10\log (11.2 \times 720/1024) + 5 + 8 = -87 \text{ dBm}$$

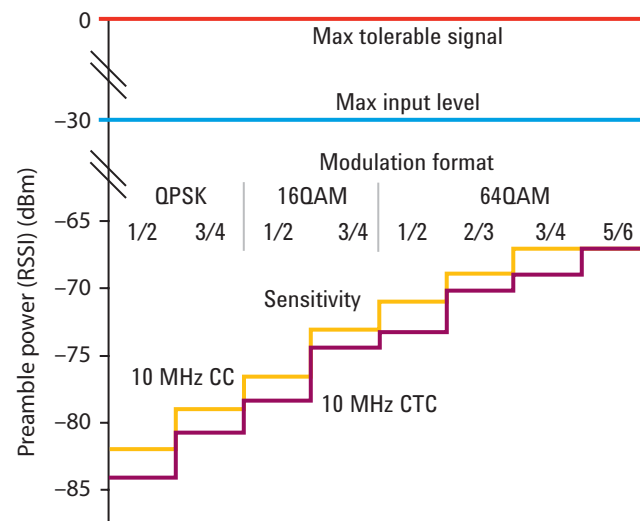

Figure 44. Sensitivity levels for CC and CTC test signals, referred to preamble power (RSSI)

All practical signals will include pilots, so the measured power will be higher than the data-only values in the equation. The Table 9 shows examples of the offsets needed if the RSSI value or a broadband power measurement is used. (For convenience, these values may be entered as offsets in Signal Studio).

Table 9. Necessary offset if RSSI or broadband power measurement is used in measuring Rx sensitivity based on IEEE 802.16 values

| Level controlled using | Amplitude offset for fully occupied PUSC Zone | Calculation |
|--|---|--|
| Broadband power measured over data symbols | 1.13 dB | $10\log\{(720+120 \times 16/9)/720\}$ |
| RSSI | 5 dB | $-10\log(8) - 10\log(284) + 10\log(720)$ |

Note: The values used in the MCRT tables assume all the subcarriers, including those allocated as pilots, are at the same power level. This is not the case in practice. The sensitivity tests are considerably more complex than maximum input because of the inclusion of multiple zone types and the addition of fading channels.

5.3.1 PER results

Figure 45 shows some PER results obtained from a DUT using an AWGN channel, plotted by reducing the absolute input power to the DUT. The BS preamble (RSSI) level was used as a reference; therefore 5 dB has been added to the -87 dBm limit calculated earlier.

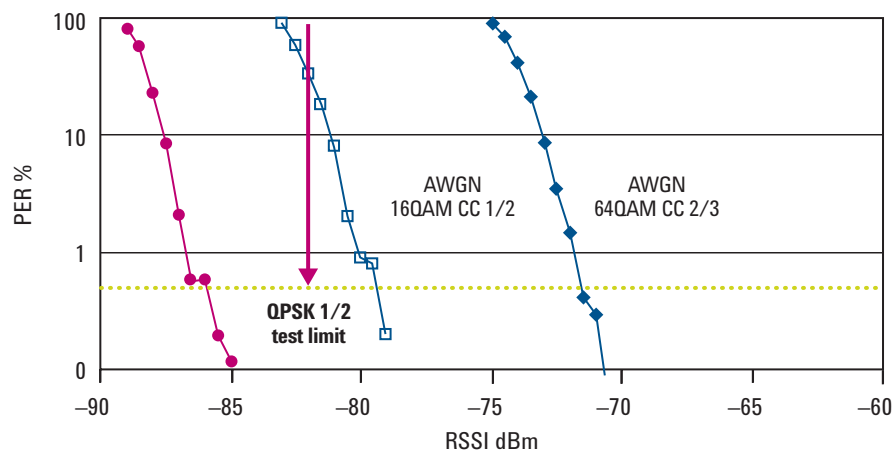

Figure 45. Sample results from 10 MHz PCMCIA card in AWGN channel. This DUT has a margin of several dB in the QPSK performance

An alternative to reducing the power level into the DUT is to add broadband noise in the source. Uncorrelated noise is required to emulate the noise floor in dual receiver, in which case two different generators are required.

When a faded channel is applied to the test signal, there are wide variations in the receiver's frame-by-frame ability to recover individual bursts. By generating an individual faded frame and changing the fading seed, we can see which signals are more difficult for the receiver, and use these for improving the demodulator performance. A sample of fading seeds could be used for quick regression testing, or relative testing between designs.

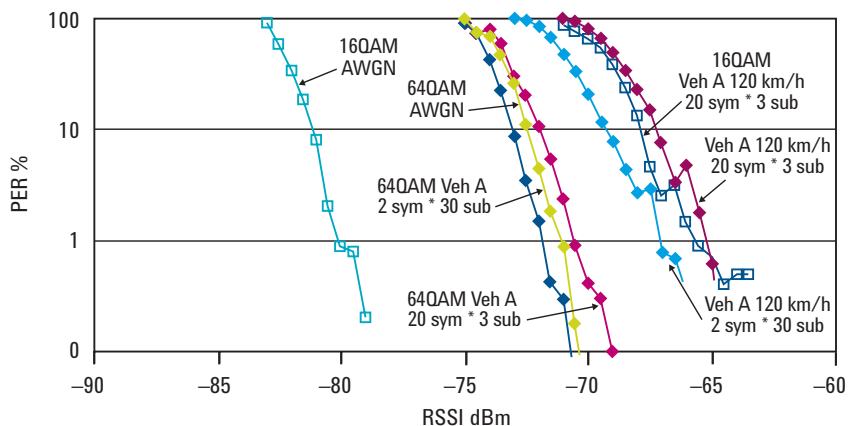

Figure 46. Variation in instantaneous PER for 16QAM and 64QAM bursts showing the effect of burst shape on PER with Vehicular A 120 km/h channel sample

For a repeating data frame, Figure 47 gives an example of the variation in RF level needed for 10 percent PER (blue line) and the CNR reported (pink line) as the fading channel seed is incremented. A sample of seed values could be used to get an indication of receiver performance in more and less demanding situations.

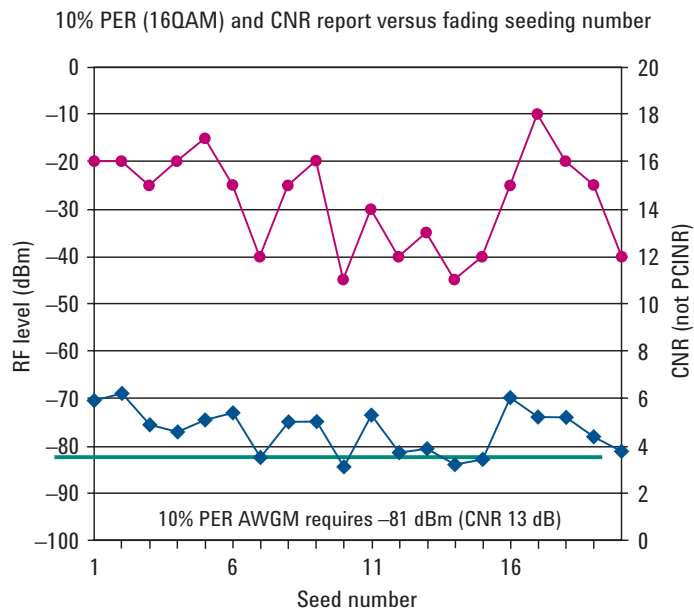

Figure 47. Variation in CNR and 10 percent PER level for individual frames with different fading channel seed values

The upper (pink) trace uses data recovered from the vendor software running the PER test or from the front panel display of the E6651A.

For conformance testing, a statistical approach is taken. The total packet loss over 10,000 (pedestrian and vehicular channel) or 30,000 (AWGN channel) packets is measured.

5.4 Channel reports, RSSI, and CINR

The BS has to transfer data to multiple mobiles, balancing power and modulation continuously to suit the channel conditions as they change. Channel reports are a key operational element in this radio resource management control loop. Each MS provides regular channel reports to allow the BS to choose an appropriate MCS for the downlink data and make handover decisions. These reports are RSSI and CINR.

5.4.1 RSSI

The MS receiver, when requested by the BS to report the RSSI measurement, should measure the preamble of the BS, which is transmitted in every frame, and report back the mean and standard deviation values with a specified accuracy. The accuracy is expected to be satisfied for the entire RSSI range and under typical channel/interference conditions. The RSSI should read the same as the default power level from Signal Studio and the front panel power setting on the E6651A.

| | Relative | Absolute |
|----------------------|------------|------------|
| RSSI accuracy | ± 2 dB | ± 4 dB |

There are two stages to this test: 1) the test with no interference (the answer will read the same as a wideband power measurement gated over the preamble) and 2) the test with an interfering BS on same frequency and same segment ID, but with different cell ID.

When running the test with the E6651A, signaling is used to set the output power level to different values and recover the RSSI level reported by the MS. Figure 48 gives an example of the errors seen at higher powers (beyond the upper test limit of -40 dBm). From the IEEE specification, the test is run down to levels -123 dBm, but the MS will not be able to remain synchronized to the BS at this level. The lower conformance limit is -90 dBm.

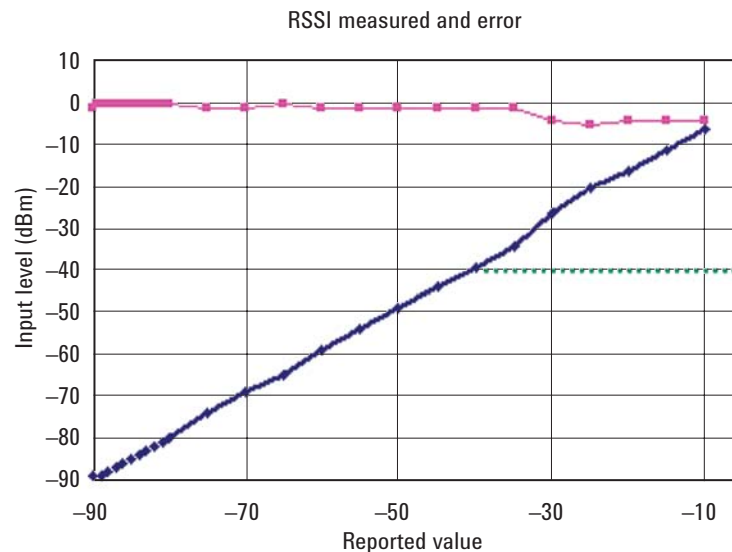

Figure 48. Typical RSSI reports versus input level. The purple line shows the error

Note: In some practical measurements, it has been noted the RSSI report may come from the second receiver of the radio hardware rather than the one shared with the transmitter. If two generators are being used for testing, a static coupling of 1,1,0,0 in Signal Studio will put the SISO signal on both outputs. Alternatively, a power splitter may be used.

Adding a second carrier in the Waveform Setup menu of Signal Studio allows the test to be run with an interferer.

5.4.2 Physical CINR

Physical CINR (PCINR) and effective CINR (ECINR) reports are fed back to the BS as part of the scheduling control process. Accurate reporting of CINR is essential to allow the BS to choose an MCS that can be decoded by the MS. A logical fast feedback channel allows for the quick compensation of the effects of fading. The data for this channel is sent at the start of the UL signal.

The PCINR result takes one of two values depending on the fractional frequency reuse applied to the cell. Fractional frequency reuse allows all or 1/3 of the available subcarriers to be allocated to a particular base station sector. It provides the network operator with more flexibility in the design of the system.

The purpose of the test is to confirm the MS CINR measurements and report if the calculated values match the serving base station (SBS). To simulate conditions similar to those in a real system, the conformance test involves complex combinations of interference sources and radio channels. Tests with fading radio channels require averaging because the CINR result will be constantly changing.

5.4.3 Definition of PCINR

PCINR estimates the C/(N+I) ratio that the MS will encounter on non-boosted data subcarriers, where N is the broadband noise and I is the interference from a neighboring BS. At first, this seems a lot like a data-EVM measurement, which it actually is; the main issue is the interference term. The BS under test and the interfering BS will transmit with different DL-MAPs, so there is no way to know how much their MAPs overlap (i.e. how much actual interference exists) at any given moment. Thus, while an instantaneous EVM measurement does show the instantaneous CINR, that value is not very meaningful because the following symbol (or frame, or zone) could have significantly more overlap, or significantly less, or anywhere between. To compensate for this, PCINR is defined as a worst-case metric. It is measured during the preamble, when the amount of overlap is maximized, and where the subcarrier use of both base stations is known.

PCINR is defined as:

$$\frac{3/8 \times C_{pmb1}}{3/8 \times I_{pmb1} + N} = \frac{C_{pmb1}}{I_{pmb1} + 8/3 N}$$

Where C_{pmb1} and I_{pmb1} are respectively the transmitted power and interference power, as measured during the preamble symbol.

The 3/8 terms above are used to scale down the preamble-based measurements to an estimate of the data-tone CINR. Both C and I need to be reduced by 3/8 (i.e. 1/8 because of the 9 dB preamble boost, and x3 due to the reduced number of tones). Conversely, N is broadband noise, and would be the same level wherever measured, and hence needs no scaling.

In practice, the BS may request one of two types of PCINR, based on its knowledge of the network configuration. These are:

PCINR-R1: Used when the neighboring BS is on the same channel, but with a complementary preamble segment so the tones do not overlap. In this case, the interference level is easily measured as the signal power on the locally-unused preamble tone frequencies. In simplified form:

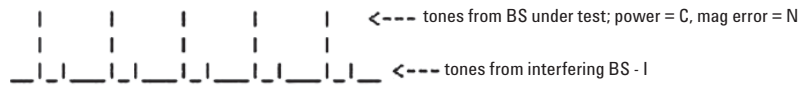

PCINR-R3: Used when the neighboring BS is on a different channel altogether. In this case, the interference is assumed to come from a more distant CS (perhaps from two distant cells), not using a complementary preamble segment, and thus transmitting on exactly the same preamble frequencies as the BS under test. In this case, the power between tones is all noise, while the error on the tones is the interference.

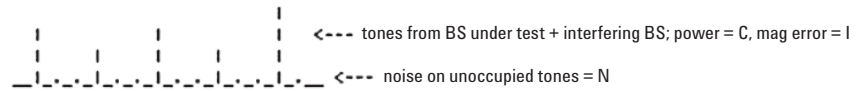

Note: If broadband noise is used for testing, $PCINR = CNR - 10\log(8/3)$ i.e. offset CNR by -4.26 dB to get the expected PCINR reading. CINR with reuse three will be about 5 dB worse than reuse one.

A detailed description of the conformance test including fading is beyond the scope of this application note. The measurement includes the need to know the instantaneous fading gains of four independent paths. If the fading gain is the difference between the average power of the preamble at the input of the channel and the output, this could be measured in advance. A basic test could use a sequence of individually seeded faded frames, where the fading gain can be pre-calculated.

5.4.4 ECINR

ECINR is a qualitative metric for the signal following all demodulation processes. It is not expressed in dB, but rather in terms of the power, modulation, and coding the BS must use for a given channel condition.

5.5 Interference and channel immunity (adjacent and non-adjacent channel rejection)

A MS must be able to receive an OFDMA signal at its assigned channel frequency in the presence of an adjacent channel signal. For a 10 MHz bandwidth signal, this would be ± 10 MHz from the center of the carrier frequency. A non-adjacent channel, in this context, is ± 2 channel spacing (CS) apart.

Figure 49 shows the level settings of the wanted signal and interferer, assuming $\frac{3}{4}$ rate CTC coding.

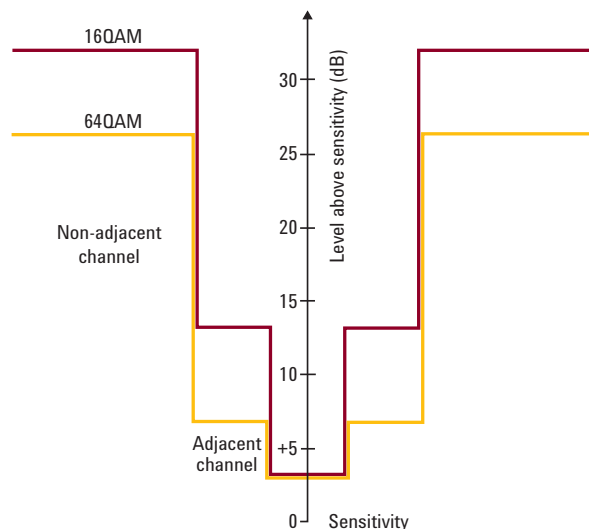

Figure 49. Wanted and interferer levels relative to sensitivity absolute test limit

A formal test requires the interference to be asynchronous with the wanted signal. A preliminary basic test can be run by adding two carriers to an ARB waveform. It is important for the adjacent channel leakage ratio (ACLR) of the test source to be low enough (–40 dB for adjacent and –60 dB for non-adjacent channels) to avoid masking the result with an in-band interferer. Refer to the transmitter test section for details on ACLR measurements.

5.6 Receiver preambles (and cyclic prefix)

The BS preamble is chosen from a selection of well separated codes, giving relatively low PAPRs, typically around 4 dB, which are easy for the receiver to identify. It is transmitted on the first OFDMA symbol, and identifies a cell, allowing the MS receiver to begin channel training. The segment number defines which subcarriers get used in preamble. The cell ID defines what data is carried on those subcarriers.

This test makes sure that the MS can synchronize to, and successfully receive, all the different types of preambles, cell IDs, and segment IDs that can be sent on the DL by the BS. It should be possible for the MS to decode another cell on the same frequency, with the same segment (subcarriers) being used in the preamble.

To run the test, cycle through each of the 114 preamble index values that the BS can transmit. For each one, the MS must synchronize and complete the ranging process. Successful ranging implies the test is passed. The test is run with and without an interfering signal. The ability of the MS to decode the OFDMA symbols with a 1/8th CP is inherently verified when this test is run. The test can be run using Signal Studio or the E6651A.

5.7 Hybrid ARQ

Operating the radio network with a high PER, in the region of ten percent, reduces the CINR requirement and increases the radio network's overall capacity. However, the basic response mechanism for user data not being received is for the MAC to organize packet retransmission. The ARQ mechanism used for this tends to introduce relatively long delays, and can cause greater packet fragmentation. Both scenarios have a significant effect on time-dependant applications, such as video streaming or gaming. Retransmission using HARQ is much quicker than higher-layer protocol retransmission. HARQ removes latency from the system as a whole.

A large portion of the HARQ test verifies the correction operation and timing of protocol functions, but the test configuration defines how impairments are added to stimulate the need for retransmissions. The test consists of a series of sub-tests, including:

- Checking the MS sends ACKs on the ACKCH with correct timing by sending HARQ bursts to MS and monitoring responses
- Checking MS sends NACK by sending HARQ bursts with modified CRC
- Checking chase combining provides the intended gain in decoding success by sending repeated bursts below sensitivity
- Checking declared category parameters (maximum HARQ DL bursts in the sub-frame, maximum HARQ DL channels, and declared memory)

A description of specific test details is beyond the scope of this document. When using Signal Studio, testing can involve sending chosen sequences of frames. The E6651A has a HARQ test mode for RCT-like testing using CRCs that have been inverted.

6.0 Power Supply Measurements

All equipment designs need to be tested at extremes of supply voltage, even if specifications do not require it. Operating limits will vary according to the conditions imposed by the host device, whether a PC or a combination cell phone. Other power supply measurements can also be very informative. These include the current consumption as a function of the operational state of the device. Receiver power management is part of the specification (e.g. sleep mode), because current consumption for listening is similar to that for transmitting. Careful timing of the receiver's active periods is required. The longer oscillators and digital circuitry are turned off, the longer the battery life. Monitoring power supply current relative to the timing of radio transmission or reception helps ensure that firmware and hardware work together as expected. It is also straightforward to make before and after comparisons following firmware updates to ensure that no unwanted changes have occurred. Battery emulation allows repeatable testing of a DUT under realistic conditions.

Agilent offers a complete line of DC power supplies for these tests. These include general-purpose instruments, as well as instruments specifically tailored to the demands of mobile communication. These DC voltage supplies also offer low-current measuring capability, which is useful for evaluating battery consumption during standby operation.

New WiMAX devices need to be optimized for battery drain to maintain the host's run-time. As a result, battery drain analysis is useful throughout the product life cycle:

| | |
|----------------------|---|
| R&D | Optimize operating time by visualizing and analyzing current drain results for changes, anomalies, and sub-circuits |
| Design validation | Evaluate product against suites of benchmark tests |
| Software development | Validate impact of new code with regression test suites |
| Product launch | Validate battery drain for published specifications, industry standards, and service provider standard benchmarks |

More than ever, battery operating time is a critical factor for mobile wireless device designs. In particular, new WiMAX device designs draw a significant amount of power in order to achieve required performance, and quickly run down the host device's battery. It is critical that current drain is improved for future WiMAX devices.

Making advanced battery current drain measurements is a primary means for validating and optimizing the run times of mobile devices. It turns out there is a large variety of current drain measurements required by a number of different areas for different reasons. In many cases it is necessary to be able to tightly couple and synchronize DUT RF and other stimulus and measurements with the battery current drain measurements. The traditional approach has been to custom design and develop such a complex system in-house. Doing this is not without very significant challenges, including, but not limited to:

- Making accurate current measurements
- Spending many months of time developing custom programs
- Managing all the measurement data as logging over extended periods can create gigabytes of data
- Creating useful tools to display and analyze the data
- Supporting the solution across your organization

To streamline this process, Agilent has developed a number of time-saving tools:

Agilent 14565B software

Software for characterizing and optimizing current drain of new WiMAX devices

- Program interface allows the N6422C to control the 14565B to automate DC and RF testing of the WiMAX wireless device
- Three modes of operation for capturing, analyzing, and optimizing battery drain

Agilent 66321B DC source

Specialized for wireless mobile device test

- 15 V, 3 A fast response output for powering a variety of devices
- High speed 64 KSa/s 16 bit digitizer
- Three ranges span μA to A for accurate sleep, standby, and active current measurements
- Works with the 14565B software to create a battery drain analysis solution

Figure 50 shows an example configuration for characterizing current drain in combination with RF stimulus and measurements on a USB-based WiMAX WWAN adapter for a client laptop.

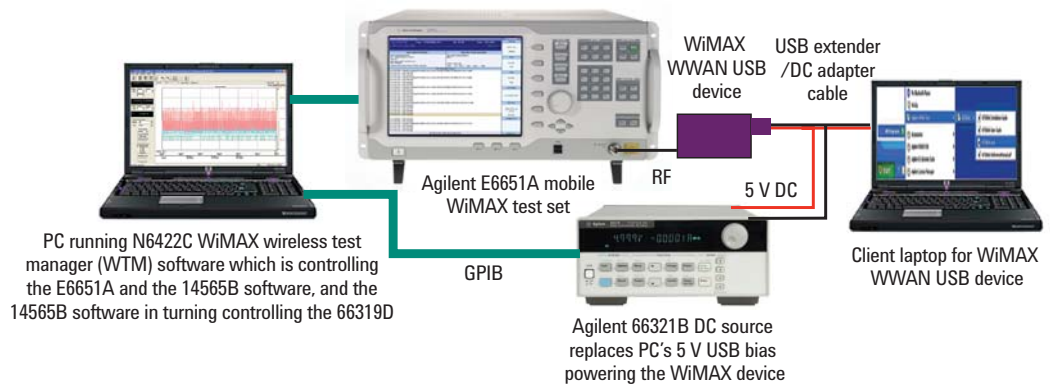

Figure 50. Automated system for combined RF and DC stimulus and measurement

The E6651A Mobile WiMAX test set provides the appropriate RF stimulus and measurement for controlling the WiMAX device.

By using a suitably modified USB extender cable, the 66321B DC source replaces the 5 V USB bias from the PC so it powers and makes current drain measurements on the WiMAX WWAN USB device. The 66321B DC source has a 15 V, 3 A output, a high speed 64 KSa/s 16-bit digitizer, and three current measurement ranges for making accurate current drain measurements from micro amps to amps. It works with the 14565B software for battery drain testing.

Finally, a control PC running the N6422C WiMAX wireless test manager (WTM) software is controlling the E6651A test set, as well as the 14565B battery drain analysis software, which is in turn controlling the 66321B DC source.

The 14565B software features a programming interface that allows it to be called and controlled from a variety of programs and programming languages. As illustrated in Figure 51, it is done by the N6422C WiMAX WTM software. Automating RF and DC current drain testing greatly reduces the time and effort for this testing that is normally performed manually. The 14565B features three useful modes for current drain testing.

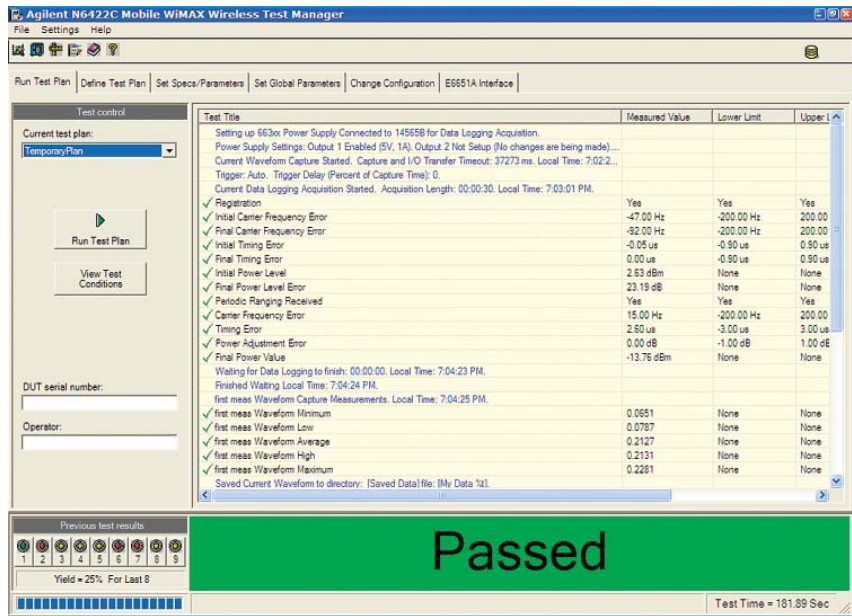

Figure 51: User interface of the N6422C WTM software

The test plan defined in the N6422C (Figure 51) establishes communication with the WiMAX device. It has two loops: one to sequence the BTS frequency, and one to sequence the MS Tx power level. In the inner loop, a Tx power level measurement is made and a corresponding extended current drain measurement is made using the 14565B data log mode. The test plan sequences through its steps, through program calls it initiates the 14565B software, sets up the power supply, and gets the battery drain measurements returned to it.

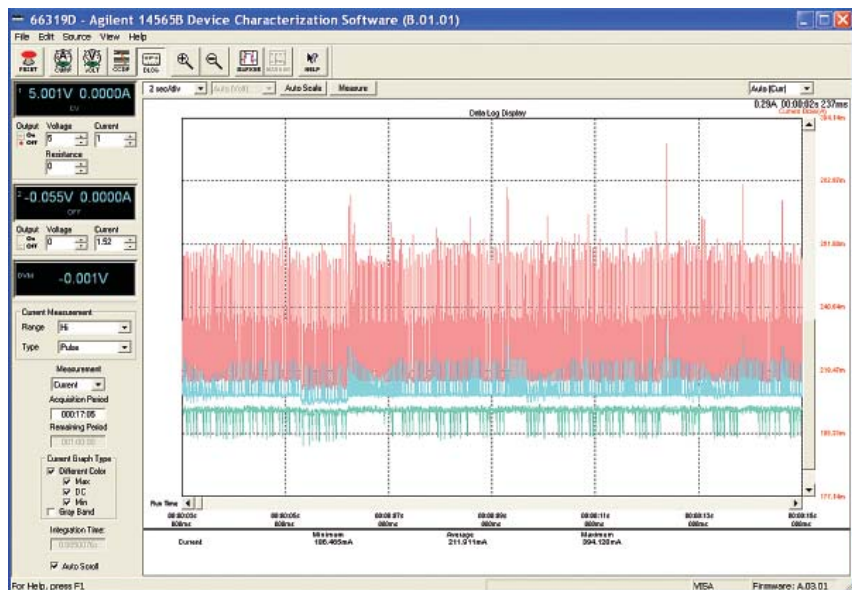

Figure 52: Device current as function of time in seconds

When there are hundreds of combinations of conditions, this testing, which can literally take days or even up to a week or more to run manually, is reduced to a couple of hours of setting up, initiating, and leaving it on its own to automatically complete all the characterization testing. Likewise, the programming effort is minimized by using Agilent software developed for this testing.

Conclusion

This application note has described the operation and PHY layer measurement of 802.16 OFDMA mobile stations. The signals have been shown to be complex, which leads to a need to control both the device operation and the measurement configuration to get reliable and repeatable results. The considerable flexibility of the existing IEEE 802.16 specification will be further expanded with 802.16 Rev 2 and 802.16m. The measurements described in this document should act as the basis for evaluating both current and future designs.

Appendix A: Agilent Solutions for Mobile WiMAX

Agilent equipment for Mobile WiMAX PHY layer RF testing

WiMAX (802.16e) RF tests

| RF WiMAX tests | 89601A Series VSA software with WiMAX test options ¹ | PSA Series spectrum analyzer ² | MXA signal analyzer with WiMAX test options ³ | Signal Studio for WiMAX test with Agilent MXG and ESG vector signal generator ⁴ | P-Series power meters | E6651A mobile WiMAX test set |
|--|---|---|--|--|-----------------------|------------------------------|
| WiMAX transmitter test | | | | | | |
| Output power | X | X | X ⁵ | | X ⁶ | X |
| Power rise/fall | X | X | X | | X | |
| Spectrum mask | | X | X ⁵ | | | |
| Spectral flatness | X | X | X | | | X |
| Center frequency tolerance | X | | X | | | |
| Symbol clock frequency tolerance | X | | X | | | |
| Relative constellation error (EVM) | X | | X | | | X ¹⁰ |
| Out-of-band spurious emission | | X ⁷ | X ⁷ | | | |
| WiMAX receiver tests | | | | | | |
| Sensitivity | | | | X ⁸ | | X ¹¹ |
| Maximum input level | | | | X | | X |
| Adjacent and alternate channel rejection | | | | X ⁹ | | |
| Receiver linearity | | | | X | | |
| Frequency and timing requirements | | | | X | | |

1. 89600 Series vector signal analysis software can be used with a variety of digitizers including: PSA and ESA-E spectrum analyzers, MXA signal analyzers, N4010A wireless connectivity test sets, oscilloscopes, logic analyzers, and VXI.
2. Power measurements are available in Power Suite. However, limit lines and other WiMAX parameters require manual user setup.
3. Requires 89601A VSA software or N9075A measurement application for 802.16 OFDMA.
4. Can also be used with E8267D PSG vector signal generator.
5. These measurements require time gating.
6. Thermal sensor gives true rms power reading. Peak detector under-reads peak-average result with OFDM/modulation applied.
7. Requires manual user setup in range table.
8. Test signal is fully coded, which enables vendor-specific PER measurements to be performed. The ESG/PSG/MXG does not perform PER measurements.
9. Use a second signal generator with user-created waveform file as interferer.
10. Active subcarriers only. Unused subcarrier RCE is not measured.
11. Fader required for part of the test.

Test equipment with Mobile WiMAX test capability

1. 89601A vector signal analysis software with Option B7Y

The software Option B7Y offers an advanced and comprehensive tool set to evaluate the complex IEEE 802.16e-2005 OFDMA PHY layer signaling format. Supports Wave 2 WiMAX signals: 2-channel MIMO, AAS, and STC antenna 0 and 1. Covers all zone types: PUSC, OPUSC, FUSC, OFUSC, and AMC. Analyzes all bandwidths from 1.25 MHz through 28 MHz and FFT sizes 128 to 2048. Advanced modulation analysis: QPSK, 16QAM, and 64QAM. Handles uplink and downlink forms. Monitors PBRS status information. Automatically decodes and displays FCH, DL-MAP, and UL-MAP for dynamic auto-configuration. Supports preamble measurements such as RCE, PCINR, R-1, and R-3, and more.

2. PSA and MXA vector signal analyzers

The PSA Series spectrum analyzer measures and monitors complex WiMAX signals. It provides spectrum measurements with bandwidth up to 80 MHz. Key features include user-definable limit lines to simplify spectrum emission mask measurements. Use the PSA with the 89600 Series VSA software for in-channel signal analysis. The MXA signal analyzer provides a new cost-effective solution for measurement of WiMAX signals for bandwidths up to 25 MHz. With its ability to run both the 89600 vector signal analyzer software internally, as well as an embedded Mobile WiMAX measurement application (N9075A), the MXA is suitable for both R&D and volume production testing of Fixed and Mobile WiMAX devices.

3. ESG and MXG vector signal generators with N7615B Signal Studio

The E4438C ESG vector signal generator and new Agilent MXG signal generator with Signal Studio provide pre-configured WiMAX waveforms and enable you to configure your own test signals for thorough stimulation. Use the N7615B Signal Studio for Mobile WiMAX with the ESG and Agilent MXG. Flexible parameters include bandwidth, cyclic prefix ratio, preamble ID, data content, and power boosting (OFDMA). The software may be downloaded free of charge for evaluation from www.agilent.com/find/signalstudio.

4. E6651A Mobile WiMAX test set

The E6651A incorporates flexible base station emulation and RF parametric tests into one integrated unit. It includes a suite of RF measurements used for characterization, calibration, and verification purposes. The test set provides flexible profile support with RF signal generation and signal analysis capability up to 6 GHz. With realistic base station emulation, the Mobile WiMAX test set offers a controlled environment in which to verify network entry, traffic connection, and functional performance. It provides the flexibility to configure a range of network parameters allowing you to test, stress, and debug the protocol and data handling capabilities of your design. Software tools are available to enable protocol and application testing.

5. N1911 and N1912A Wideband power meters

The N1911A/12A P-Series power meters and N1921A/22A wideband power sensors combination perform fast and accurate measurements of peak/average/peak-to-average ratio power, rise/fall time, maximum/minimum power, and CCDF statistical data for wideband signals. With the 30 MHz wide video bandwidth and 100 MSa/s continuous sampling rate, it can capture signals' fast power transitions. The P-Series power sensors provide high dynamic range for better sensitivity, enabling reliable measurement of peak and average power. Further simplifying measurement set up, the P-Series power meters provide a one-button preset for WiMAX signals.

6. ADS E8874A simulation software

The Advanced Design System (ADS) Connected Solutions Workbench for WiMAX and E8869 Mobile WiMAX wireless library have the flexibility to simulate OFDMA systems during development. The WiMAX library includes space-time-coded (STC) signal generation and analysis. Documented example designs are available to help you use the tool in simulation and measurement. Virtual prototyping is available when used in conjunction with the E4438C ESG signal generator and the 89600 Series VSA software. Additional ADS software packages dramatically extend simulation flexibility and insight.

Other test equipment

1. RF shielded enclosure

Allows repeatable RF measurements to be made without interference from external environment.

2. DC sources: 66319/66321B/D

Fast, programmable dynamic DC power sources with battery emulation software.

3. Logic analyzers: 1680/1690 Series

Comprehensive system-level debugging for digital hardware design and verification.

4. Logic analyzers: 16800/16900 Series

Provides comprehensive system-level debugging for multiple processor/bus designs.

5. Mixed signal oscilloscopes: 6000 Series

Use for verification and debugging of baseband signals.

6. Network analyzers: E5071C

Provides measurement of antenna VSWR and assess performance of PA, LNA, and RF switch.

7. Function generator: 33250A (80 MHz function/arbitrary waveforms)

Generate clock signals and noise, or combine with an oscilloscope to reproduce baseband waveforms.

Accessories

1. Oscilloscope probe: 54006A

Passive probes with very low capacitance (0.25 pF.)

2. Close field probe: 11940A

Measures magnetic field radiation up to 1 GHz.

3. Splitter: 11667A

Use for ratio measurements and equal power splitting.

4. Single (773D) and dual directional couplers (772D)

Use for signal separation in RF testing.

Appendix B: Resources

Web

Agilent WiMAX home page
www.agilent.com/find/wimax

WiMAX Forum
www.wimaxforum.org

IEEE 802.16 Working Group
www.ieee.org802.0rg/16

Training

- Tech Online IEEE 802.16e OFDMA webcast (archived – original presentation September 2005) http://seminar2.techonline.com/s/agilent_sep1505 or go to www.agilent.com/find/wimax for an archived version)
- WiMAX Wave 2 Testing – MIMO and STC eSeminar, Jan 2008
<http://www.home.agilent.com/agilent/eventDetail.jsp?nid=-35762.0.08&lc=eng&cc=US&ckey=1279750&id=1279750>

Demo Software

Free trial license mode of 89601A VSA software with Option B7Y 802.16 OFDMA modulation analysis is available. The software includes example OFDMA signals and extensive help text with measurement tutorials. This is available by ordering literature number 5980-1989E.

Application Notes

- *IEEE 802.16e WiMAX OFDMA Signal Measurements and Troubleshooting*, Application Note 1578, literature number 5989-2382EN
- *Agilent N1911A/N1912A P-Series Power Meters For WiMAX Signal Measurements*, Demonstration Guide, literature number 5989-6423EN

Articles

“Effects of physical layer impairments on OFDM systems,” Bob Culter, RF Design, May 2002,

<http://rfdesign.com/images/archive/0502Cutler36.pdf>

“WiMAX: The Next Generation of Broadband Wireless Access,” Allen Henley, Electronics in Canada, September 2004,

http://www.home.agilent.com/upload/cmc_upload/All/CESept04_page13.pdf

“Unraveling Modulation Quality in Mobile WiMAX™ Uplink and Downlink with Multiple Zones and Bursts,” Viswanathan Ganesan, Microwave Journal, November 2007,

<http://www.mwjjournal.com/Journal/?Id=74>

Technical Overviews

- *N9075A 802.16 OFDMA Measurement Application Agilent X-Series Signal Analyzers (MXA/EXA)*, Technical Overview with Self-Guided Demonstration, literature number 5989-5353AN
- *Agilent E6651A Mobile WiMAX Test Set*, Technical Overview, literature number 5989-6438EN
- *Agilent 89600 Series Vector Signal Analysis Software: 89601A/89601AN/89601N12*, Technical Overview, literature number 5989-1679EN

Glossary

| | |
|----------|--|
| AAS | Adaptive antenna systems |
| ACK | Acknowledge |
| ACL | Adjacent channel leakage |
| ACLR | Adjacent channel leakage ratio |
| ACP | Adjacent channel power |
| ALC | Automatic level control |
| AMC | Adaptive modulation and coding |
| ARB | Arbitrary |
| ARQ | Automatic repeat request |
| AWGN | Additive white Gaussian noise |
| BB | Baseband |
| BPSK | Binary phase shift keying |
| BS | Base station |
| BWA | Broadband wireless access |
| CC | Convolutional coding |
| CDF | Cumulative distribution function |
| CCDF | Complementary cumulative distribution function |
| CID | Connection identifier |
| CINR | Carrier to interference plus noise ratio |
| CTC | Convolutional turbo coding |
| CP | Cyclic prefix |
| CPE | Customer premise equipment |
| CQI | Channel quality indicator |
| CS | Channel spacing |
| DHCP | Dynamic host control protocol |
| DIUC | Downlink interval usage code |
| DL | Downlink |
| DLL | Dynamic link library |
| DLC | Downlink channel descriptor |
| DL-MAP | Downlink-media access protocol |
| DL FUSC | Downlink full usage of sub-channels |
| DL OFUSC | Downlink optional full usage of sub-channels |
| DL PUSC | Downlink partial usage of sub-channels |
| DSP | Digital signal processor |
| DUT | Device under test |
| ECINR | Effective carrier-to-interference plus noise ratio |
| EVM | Error vector magnitude |
| FCH | Frame control header |
| FDD | Frequency division duplex |
| FDMA | Frequency division multiple access |
| FEC | Forward error correction |
| FUSC | Full usage of sub-channels |
| GPS | Global positioning system |
| HARQ | Hybrid automatic repeat request |
| HO | Handover |
| LOS | Line of sight |
| LCR | Level crossing rate |
| IFFT | Inverse fast Fourier transform |
| IP | Internet protocol |
| ISI | Inter-symbol interference |
| MAC | Media access control |
| MAP | Media access protocol |
| MRCT | Mobile radio conformance tests |

Glossary-continued

| | |
|----------|---|
| MCS | Modulation coding sequence |
| MIMO | Multiple input multiple output |
| MS | Mobile station |
| NACK | Not acknowledge |
| NLOS | Non line of sight |
| OFUSC | Optional full usage of sub-channels |
| OFDM | Orthogonal frequency division multiplexing |
| OFDMA | Orthogonal frequency division multiple access |
| OPUSC | Optional partial usage of sub-channels |
| PAR | Peak-to-average ratio |
| PAPR | Peak-to-average power ratio |
| PCINR | Physical carrier-to-interference plus noise ratio |
| PCMCIA | Personal computer memory card international association |
| PER | Packet error ratio |
| PHY | Physical layer |
| PMP | Point-to-multipoint |
| PN | Pseudo random number |
| PS | Physical slot |
| PUSC | Partial usage of sub-channels |
| PvT | Power versus time |
| QoS | Quality of service |
| QPSK | Quadrature phase shift keying |
| RCE | Relative constellation error |
| RCT | Radio conformance tests |
| RNG-REQ | Ranging request |
| RSSI | Received signal strength indication |
| RTG | Receive-transmit transition gap |
| SBS | Serving base station |
| SEM | Spectrum emission mask |
| SISO | Single in single out |
| SNR | Signal-to-noise ratio |
| SS | Subscriber station |
| STC | Space time coding |
| TDD | Time division duplex |
| TDMA | Time division multiple access |
| TTA | Telecommunications Technology Association |
| TTG | Transmit-receive transition gap |
| TUSC | Tile usage of sub-channels |
| Tx | Transmit |
| UCL | Uplink channel descriptor |
| UL | Uplink |
| UL-MAP | Uplink-media access protocol |
| UL OPUSC | Uplink optional partial usage of sub-channels |
| UL PUSC | Uplink partial usage of sub-channels |
| USB | Universal serial bus |
| VoIP | Voice over internet protocol |
| VSA | Vector signal analyzer |
| WiBRO | Wireless broadband |
| WiMAX | Worldwide interoperability for microwave access |
| WTM | Wireless test manager |
| WWAN | Wireless wide area network |

References

- [1] Institute of Electrical and Electronics Engineers, Inc., *IEEE Std 802.16-2004; IEEE Standard for Local and metropolitan area networks; Part 16: Air Interface for Fixed Broadband Wireless Access*, Oct. 1, 2004.
- [2] Institute of Electrical and Electronics Engineers, Inc., *IEEE Std 802.16e-2005; IEEE Standard for Local and metropolitan area networks; Part 16: Air Interface for Fixed Broadband Wireless Access Systems, Amendment 2: Physical and Medium Access Control Layers for Combined Fixed and Mobile Operation in Licensed Bands and Corrigendum 1*, Feb. 28, 2006.
- [3] Agilent Technologies, *WiMAX Concepts and RF Measurements, IEEE 802-16-2004 WiMAX PHY layer operation and measurements*, Application Note, literature number 5989-2027EN, Jan. 5, 2005.
- [4] Pandharipande, A.; "Principles of OFDM", *IEEE Potentials*, Volume 21, Issue 2, Apr-May 2002. pg 16 – 19.
- [5] Eklund, Carl, et.al. *WirelessMAN, Inside the IEEE802.16 Standard for Wireless Metropolitan Networks*, IEEE Press, 2006.

Web Resources

For more information on Agilent WiMAX solutions, visit
www.agilent.com/find/wimax

"WiMAX", "Mobile WiMAX", and "Fixed WiMAX" are trademarks of the WiMAX Forum.
"WiMAX Forum" is a registered trademark of the WiMAX Forum.
Microsoft is a U.S. registered trademark of the Microsoft Corporation.



Agilent Email Updates

www.agilent.com/find/emailupdates
Get the latest information on the products and applications you select.



Agilent Direct

www.agilent.com/find/agilentdirect
Quickly choose and use your test equipment solutions with confidence.



www.agilent.com/find/open
Agilent Open simplifies the process of connecting and programming test systems to help engineers design, validate and manufacture electronic products. Agilent offers open connectivity for a broad range of system-ready instruments, open industry software, PC-standard I/O and global support, which are combined to more easily integrate test system development.

Remove all doubt

Our repair and calibration services will get your equipment back to you, performing like new, when promised. You will get full value out of your Agilent equipment throughout its lifetime. Your equipment will be serviced by Agilent-trained technicians using the latest factory calibration procedures, automated repair diagnostics and genuine parts. You will always have the utmost confidence in your measurements.

Agilent offers a wide range of additional expert test and measurement services for your equipment, including initial start-up assistance, onsite education and training, as well as design, system integration, and project management.

For more information on repair and calibration services, go to:

www.agilent.com/find/removealldoubt

www.agilent.com

For more information on Agilent Technologies' products, applications or services, please contact your local Agilent office. The complete list is available at:

www.agilent.com/find/contactus

Americas

| | |
|---------------|----------------|
| Canada | (877) 894-4414 |
| Latin America | 305 269 7500 |
| United States | (800) 829-4444 |

Asia Pacific

| | |
|-----------|----------------|
| Australia | 1 800 629 485 |
| China | 800 810 0189 |
| Hong Kong | 800 938 693 |
| India | 1 800 112 929 |
| Japan | 0120 (421) 345 |
| Korea | 080 769 0800 |
| Malaysia | 1 800 888 848 |
| Singapore | 1 800 375 8100 |
| Taiwan | 0800 047 866 |
| Thailand | 1 800 226 008 |

Europe & Middle East

| | |
|----------------|---------------------|
| Austria | 01 36027 71571 |
| Belgium | 32 (0) 2 404 93 40 |
| Denmark | 45 70 13 15 15 |
| Finland | 358 (0) 10 855 2100 |
| France | 0825 010 700* |
| | *0.125 €/minute |
| Germany | 07031 464 6333** |
| | **0.14 €/minute |
| Ireland | 1890 924 204 |
| Israel | 972-3-9288-504/544 |
| Italy | 39 02 92 60 8484 |
| Netherlands | 31 (0) 20 547 2111 |
| Spain | 34 (91) 631 3300 |
| Sweden | 0200-88 22 55 |
| Switzerland | 0800 80 53 53 |
| United Kingdom | 44 (0) 118 9276201 |

Other European Countries:

www.agilent.com/find/contactus

Revised: July 17, 2008

Product specifications and descriptions in this document subject to change without notice.

© Agilent Technologies, Inc. 2008
Printed in USA, July 17, 2008
5989-8309EN



Agilent Technologies