

# Agilent New Phase Noise Measurement Technique Using the E5052A SSA with the E5053A

Application Note

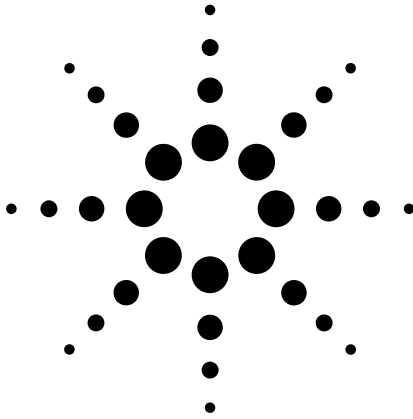

## Introduction

As the requirements for aerospace and defense radar systems continue to push existing limits, testing phase noise is becoming more and more of a challenge, particularly in the microwave and millimeter frequency ranges. Adding to this challenge is the increasing pressure from emerging communications markets for anti-collision radar, wireless LAN (WLAN), and ultra wideband (UWB), that are reaching higher frequency bands in the microwave to millimeter wave range.

## Signal Source Characterization

Agilent's E5052A signal source analyzer (SSA), along with the new E5053A downconverter, expands signal source characterization into the microwave frequency range, up to 26.5 GHz. As shown in Figure 1, the E5052A SSA provides four independent measurements that are required for the vast majority of signal source characterizations: phase noise, frequency and power, transient, and spectrum monitoring.

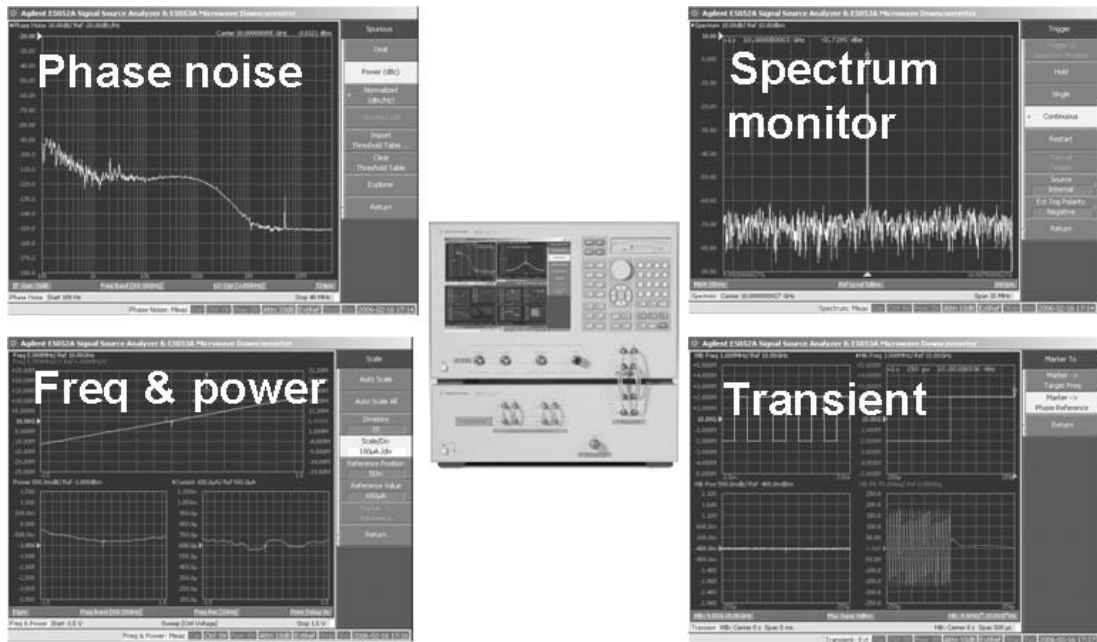

Figure 1. Four measurements for signal source characterization

# Phase Noise Sensitivity

The E5052A SSA provides excellent phase noise sensitivity at microwave frequencies (see Figure 2). The analyzer employs a unique cross-correlation technique to enhance the phase noise sensitivity without employing a clean reference source, which is often costly at this frequency range.

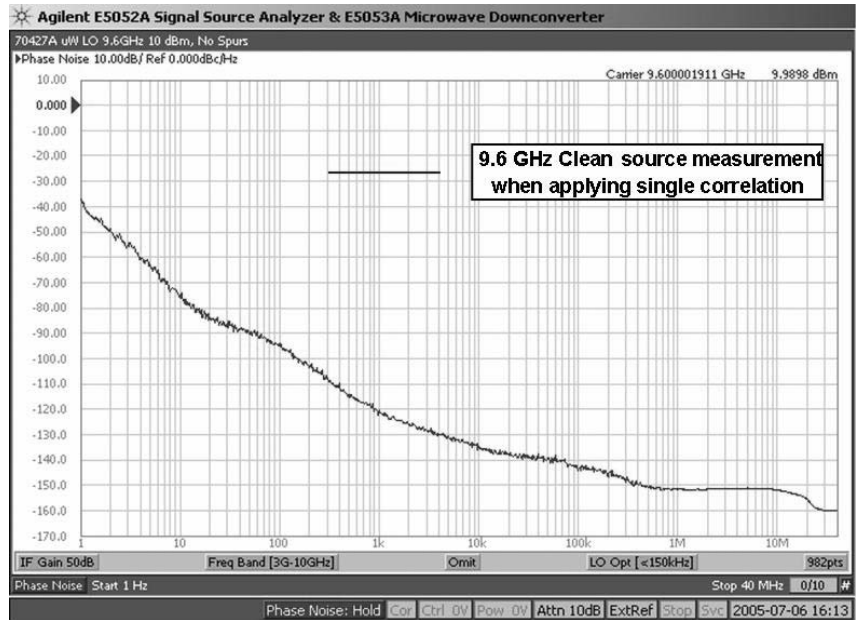

Figure 2. Screen shot of 9.6 GHz clean source measurement

This technique essentially cancels the system noise. As shown in Figure 3, Agilent's SSA consists of two independent signal paths with built-in reference sources, as well as local oscillators (LOs) in the E5053A for signal downconversion that creates signals that are uncorrelated with each other. If two signals are uncorrelated, their vector sum circuits (the total noise power from the reference sources) can be degraded by doing vector averaging while the noise signal from the device under test (DUT) is emphasized. The degree of noise cancellation depends on the number of correlations. For example, 100x correlation produces a 10 dB noise floor improvement, and 10,000x correlation produces a 20 dB improvement.

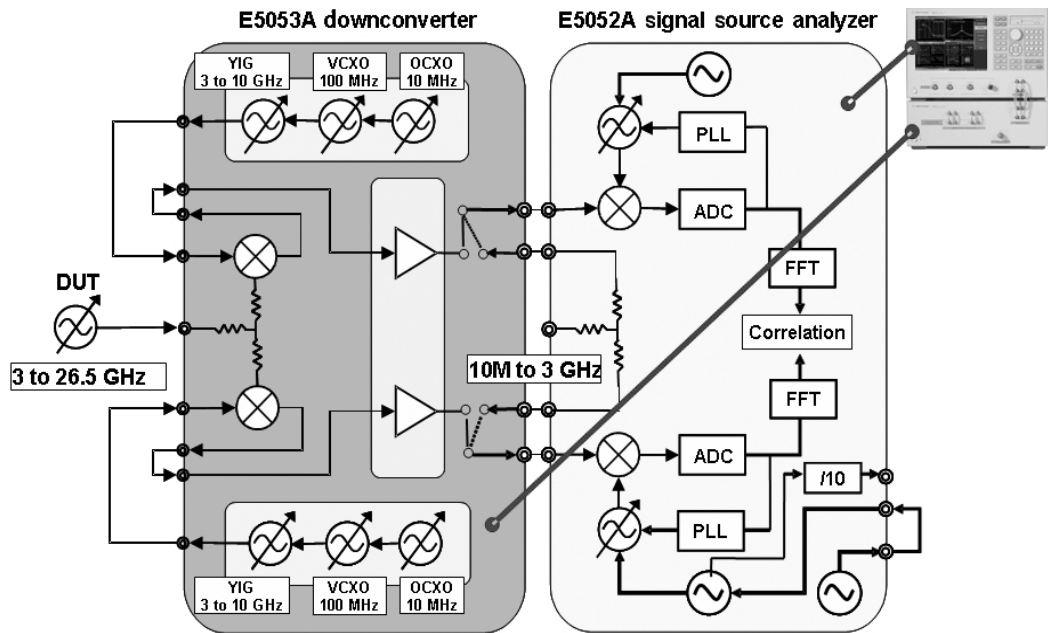

Figure 3. Block diagram of downconverter and SSA

# Expands Cross-correlation Technique to Millimeter Wave

The E5053A is designed to use two independent paths for the signal downconversion from RF to IF. Above 26.5 GHz, a power divider and a pair of external mixers can be added to extend the cross-correlation technique. By utilizing the Agilent 11970 series harmonic mixers, the frequency range can be expanded up to 110 GHz. The measurement configuration is shown in Figure 4.

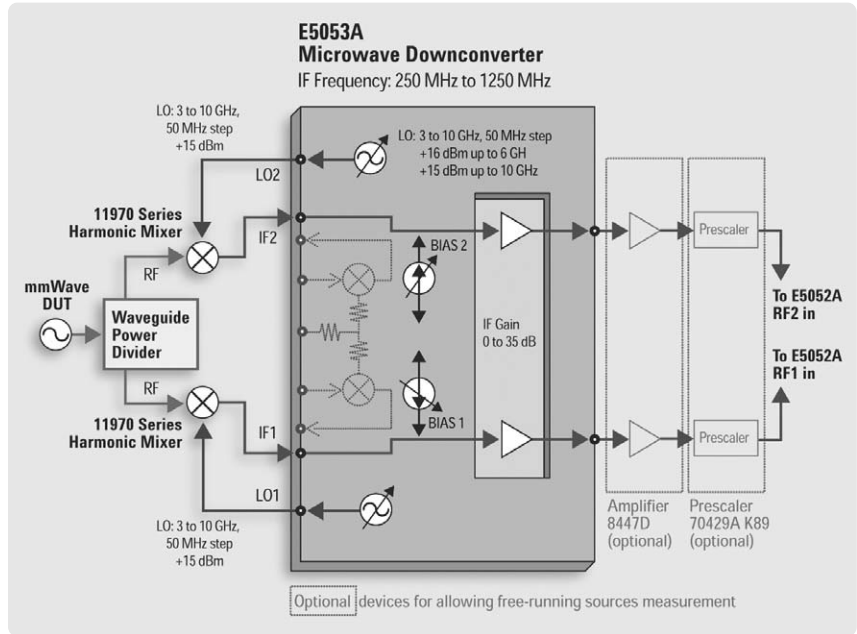

Figure 4. Block diagram of millimeter wave phase noise measurement setup

Figure 5 shows the 110 GHz stable source phase noise measurement example. A ready-to-use measurement assistant VBA running on the E5052A Signal Source Analyzer eases the setup for the E5053A parameters.

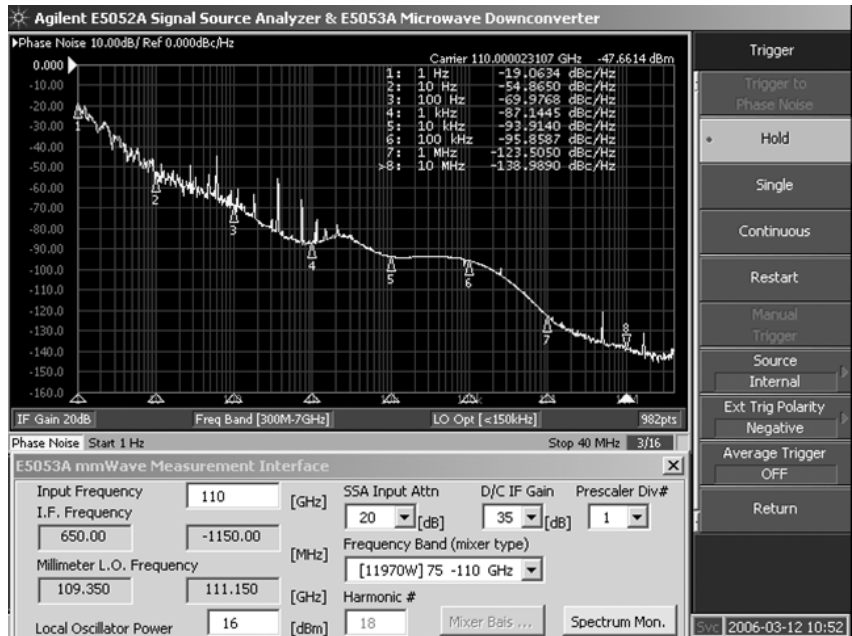

Figure 5. 110 GHz stable source phase noise measurement example

## Overcoming the Challenges of Free-running Oscillator Phase Noise Measurement

The E5052A SSA employs the reference source/phase-locked loop (PLL) technique as its most commonly used measurement method. Some free-running oscillators, such as VCO-on-silicon, exhibit large carrier drift and high phase noise, especially in the millimeter wave frequency range. Sometimes these oscillators cause measurement difficulties, such as PLL unlock and/or invalid measurements, due to the saturation of the phase detector.

Agilent's Signal Source Analyzer overcomes this obstacle with a new prescaler technique. The implementation with the E5053A, adding a pair of prescalers to the IF output signal paths, is shown in Figure 4. It suppresses large frequency drifts of the carrier signal in order to maintain the PLL. This technique also prevents the phase detector from saturating in the event of high phase noise. (See Figure 6a and 6b)

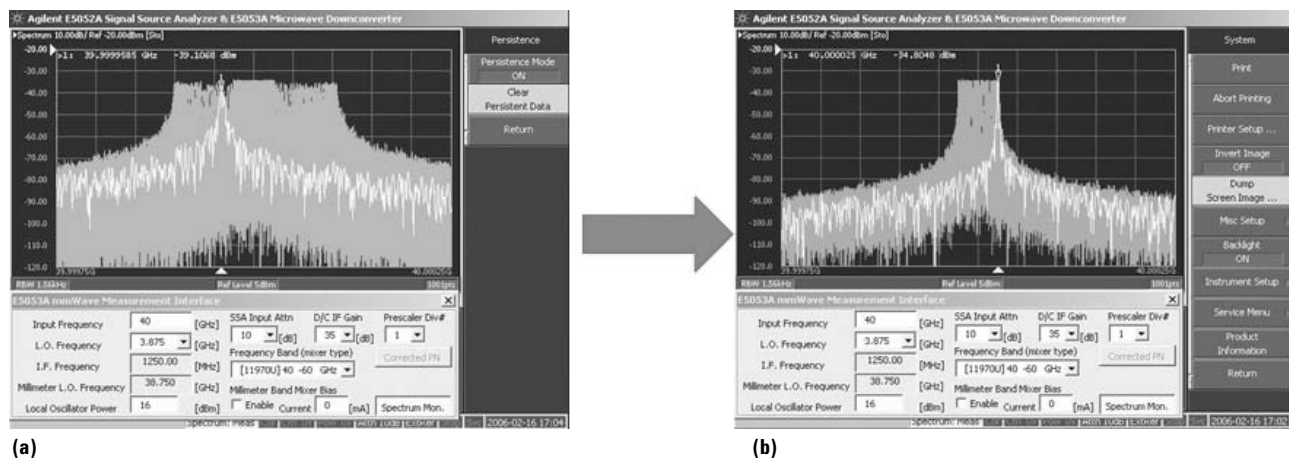

Figure 6(a). Without prescaler technique (typical unstable oscillator's signal quality Figure 6(b). With prescaler technique

The additive noise of the prescaler is also important to consider. Some free-running oscillators such as YIG (yttrium-iron garnet)-tuned oscillators (YTOs) typically have fairly good phase noise performance at wider offsets, even if the carrier drift is large. The noise floor of the prescaler determines the measurement sensitivity, especially at wide offset ranges. With the help of the cross-correlation technique, the additive noise of the prescalers can be cancelled because the noise of the prescalers is uncorrelated. Figure 7 shows the affect of the cross-correlation that removes the additive noise of the prescalers to expose the true phase noise performance of the DUT.

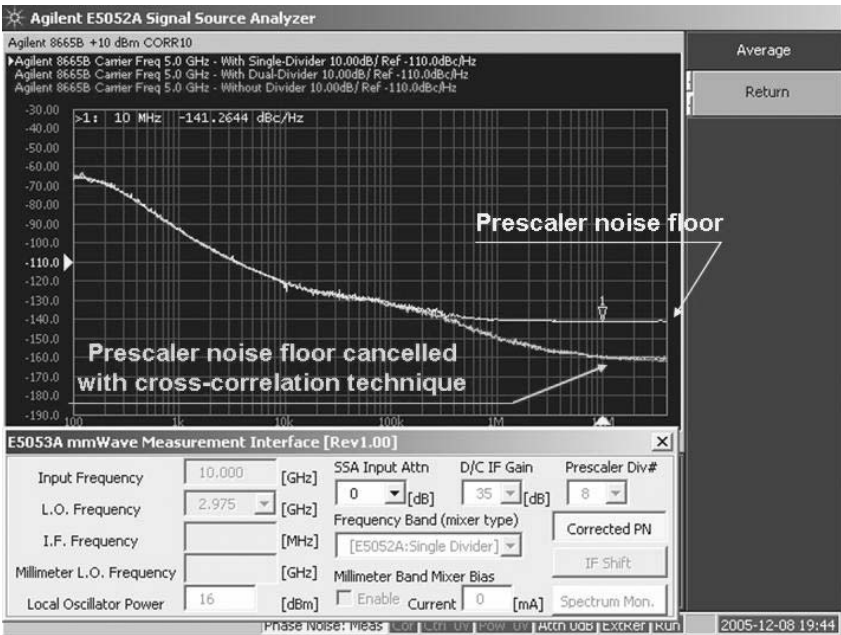

Figure 7. Affect of cross-correlation technique on prescaler noise floor

## Conclusion

Agilent’s signal source analyzer is designed to accurately test phase noise at microwave and millimeter wave frequencies. Phase noise sensitivity is achieved by using a novel cross-correlation technique, without needing to employ a costly clean reference source. Adding the prescaler technique overcomes the difficulties of free-running oscillator phase noise measurements and provides accurate measurement results.

## Web Resources

Visit our Signal Source Analyzer Web site for additional product information and literature:

[www.agilent.com/find/ssa](http://www.agilent.com/find/ssa)

Phase noise measurements:

[www.agilent.com/find/phasenoise](http://www.agilent.com/find/phasenoise)

RF and microwave accessories:

[www.agilent.com/find/accessories](http://www.agilent.com/find/accessories)

### Agilent Email Updates

[www.agilent.com/find/emailupdates](http://www.agilent.com/find/emailupdates)

Get the latest information on the products and applications you select.

### Agilent Direct

[www.agilent.com/find/agilentdirect](http://www.agilent.com/find/agilentdirect)

Quickly choose and use your test equipment solutions with confidence.

### Agilent Open

[www.agilent.com/find/open](http://www.agilent.com/find/open)

Agilent Open simplifies the process of connecting and programming test systems to help engineers design, validate and manufacture electronic products. Agilent offers open connectivity for a broad range of system-ready instruments, open industry software, PC-standard I/O and global support, which are combined to more easily integrate test system development.

## [www.agilent.com](http://www.agilent.com)

### Agilent Technologies' Test and Measurement Support, Services, and Assistance

Agilent Technologies aims to maximize the value you receive, while minimizing your risk and problems. We strive to ensure that you get the test and measurement capabilities you paid for and obtain the support you need. Our extensive support resources and services can help you choose the right Agilent products for your applications and apply them successfully. Every instrument and system we sell has a global warranty. Two concepts underlie Agilent's overall support policy: "Our Promise" and "Your Advantage."

#### Our Promise

Our Promise means your Agilent test and measurement equipment will meet its advertised performance and functionality. When you are choosing new equipment, we will help you with product information, including realistic performance specifications and practical recommendations from experienced test engineers. When you receive your new Agilent equipment, we can help verify that it works properly and help with initial product operation.

#### Your Advantage

Your Advantage means that Agilent offers a wide range of additional expert test and measurement services, which you can purchase according to your unique technical and business needs. Solve problems efficiently and gain a competitive edge by contracting with us for calibration, extra-cost upgrades, out-of-warranty repairs, and onsite education and training, as well as design, system integration, project management, and other professional engineering services. Experienced Agilent engineers and technicians worldwide can help you maximize your productivity, optimize the return on investment of your Agilent instruments and systems, and obtain dependable measurement accuracy for the life of those products.

**For more information on Agilent Technologies' products, applications or services, please contact your local Agilent office.**

#### Phone or Fax

##### United States:

(tel) 800 829 4444  
(fax) 800 829 4433

##### Canada:

(tel) 877 894 4414  
(fax) 800 746 4866

##### China:

(tel) 800 810 0189  
(fax) 800 820 2816

##### Europe:

(tel) 31 20 547 2111

##### Japan:

(tel) (81) 426 56 7832  
(fax) (81) 426 56 7840

##### Korea:

(tel) (080) 769 0800  
(fax) (080) 769 0900

##### Latin America:

(tel) (305) 269 7500

##### Taiwan:

(tel) 0800 047 866  
(fax) 0800 286 331

##### Other Asia Pacific

##### Countries:

(tel) (65) 6375 8100  
(fax) (65) 6755 0042

Email: [tm\\_ap@agilent.com](mailto:tm_ap@agilent.com)

Contacts revised: 09/26/05

**The complete list is available at:  
[www.agilent.com/find/contactus](http://www.agilent.com/find/contactus)**

Product specifications and descriptions in this document subject to change without notice.

© Agilent Technologies, Inc. 2006  
Printed in USA, May 23, 2006  
5989-5131EN