

Agilent PNA-L Network Analyzers

Application Note

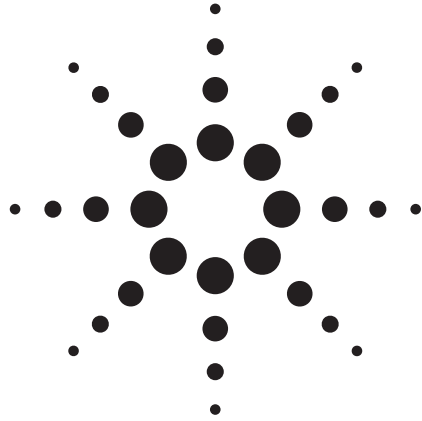

On-Wafer SOLT Calibration Using 4-port PNA-L Network Analyzers (N5230A Options x4x)

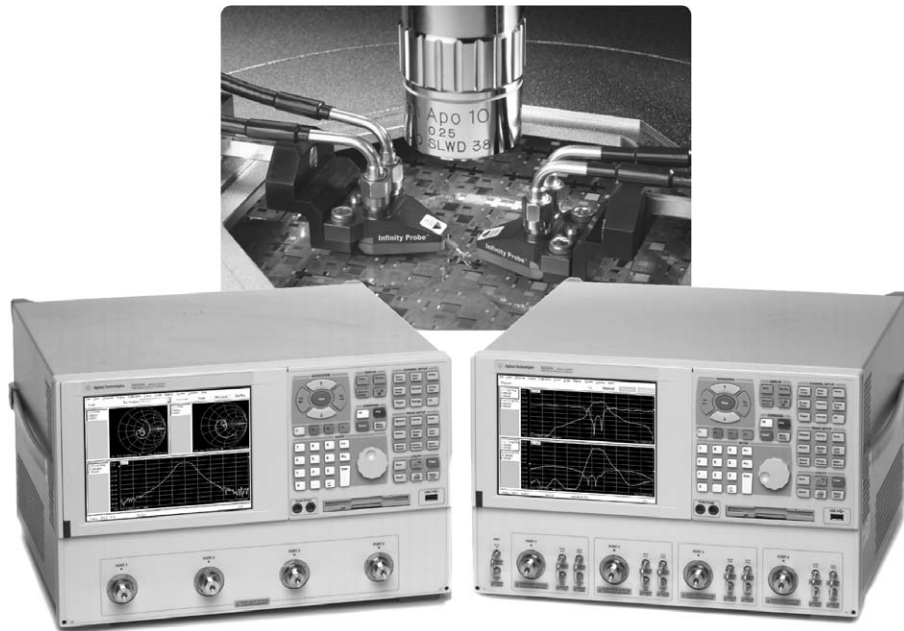

Agilent Technologies

Introduction

This application note is intended for on-wafer applications using the 4-port, PNA-L network analyzers with two dual probes to achieve full 4-port on-wafer calibrations manually. 4-port PNA-L network analyzers are available in 13.5 or 20 GHz models. PNA-L firmware revision must be 6.03 or higher.

This documentation provides step-by-step instructions needed to set up a calibration kit before a 4-port SOLT (Short-Open-Load-Thru) calibration can be performed. The steps outlined here can be applied toward nearly any kind of non-coaxial application, of which on-wafer is one.

Equipment used:

- 4-port PNA-L, N5230A with Option x4x (referred throughout this document as PNA-L)
 - Option 140, 300 kHz to 13.5 GHz, 4-port with standard test set
 - Option 145, 300 kHz to 13.5 GHz, 4-port with configurable test set
 - Option 146, 300 kHz to 13.5 GHz, 4-port with configurable test set and internal second source
 - Option 240, 300 kHz to 20 GHz, 4-port with standard test set
 - Option 245, 300 kHz to 20 GHz, 4-port with configurable test set
 - Option 246, 300 kHz to 20 GHz, 4-port with configurable test set and internal second source
- Dual probes and associated ISS (Impedance Standard Substrate)



Figure 1. 4-port PNA-L, 13.5 or 20 GHz. Unit on the left shows a standard test set (Option x40), unit on the right shows a configurable test set (Option x45) or a configurable test set with internal second source (Option x46).

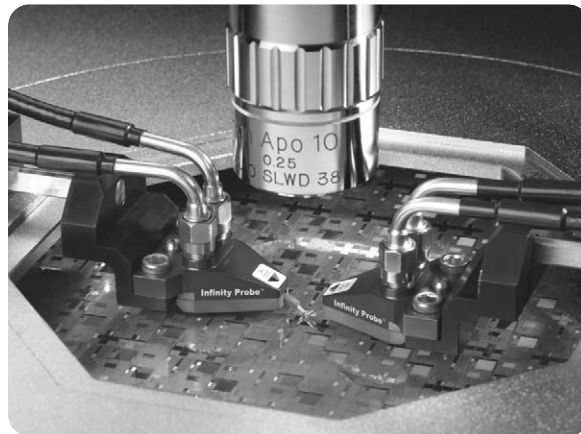

Figure 2. Dual line Infinity probe from Cascade Microtech. Available in GSGSG and GSSG configurations with pitches 100, 125, 150, 200, 225, and 250 μm . For more details, please contact Cascade Microtech at www.cmicro.com

Implementation

Although a total of six thru paths are present for any 4-port measurement setup, a minimum of only three thru paths are required with the PNA-L to yield a full 4-port SOLT calibration. (If desired, the user can choose to apply all six thru paths; but measuring more paths will take more time and will cause more wear-and-tear of the calibration standards.)

The PNA-L performs 4-port calibrations using either SmartCal (Guided calibration) or an Electronic Calibration (ECal) module. With Guided calibration, the process chooses the standards to apply from the calibration kit based on how they were defined. For on-wafer 4-port calibration, only SmartCal is applicable.

Given that most 4-port on-wafer setups tend to have one dual probe on the left and one on the right, we can assume the ports on the left are 1 and 2, and the ones on the right are 3 and 4, see Figure 3. As can be seen from this illustration, performing on-wafer 4-port calibration using dual probes would require the need to measure thru standards of different lengths because more than one thru configuration must be used during the calibration. Three of the most common configurations are "straight thru," "loop-back thru," and "cross thru," as shown in Figure 4.

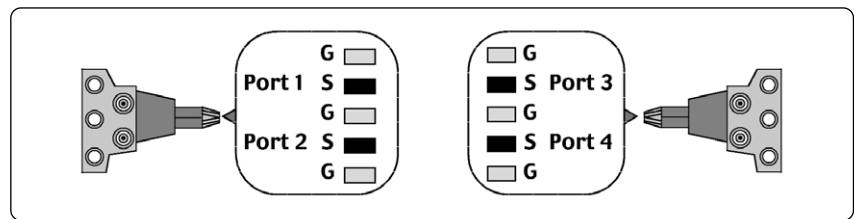

Figure 3. Port assignment used in this application note: ports 1 and 2 on the left, ports 3 and 4 on the right.

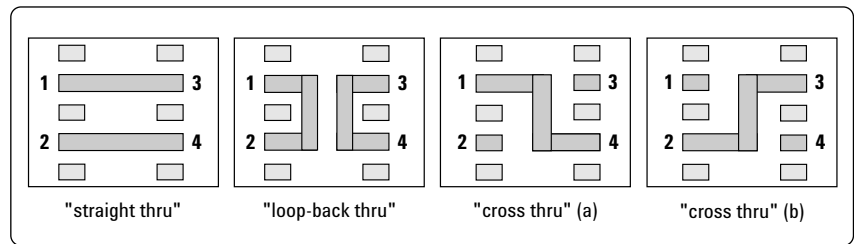

Figure 4. Examples of common thru configurations of a GSGSG probe.

With the PNA-L, the unknown thru calibration method is available and can be applied whenever through standards are not perfect. Since loop-back and cross throughs are in general not perfect, as compared to straight throughs, the unknown thru calibration method provides a much more accurate calibration. This approach is preferred because with the unknown thru method, the through standard does not need to be perfect.

Two major steps are needed to complete a 4-port on-wafer calibration manually using the PNA-L. The details in these steps describe how to properly define a calibration kit and then how to perform the actual calibration.

Step 1. Create a new calibration kit for probing.

Step 2. Perform the SOLT (Short-Open-Load-Thru) calibration.

Step 1. Create a new calibration kit for probing

Note

PNA-L [front-panel keys] are shown in brackets, while the menu items/buttons are displayed in bold; “page titles” refer to the Windows® dialog page names.

To create a calibration kit, simply follow the boxed numbers in each of the figures shown below (Figures 5 through 11).

Figure 5:

1. Click **Calibration**
2. Select **Advanced Modify Cal Kit...** – this brings up the *Edit PNA Cal Kits* dialog box
3. Click **Insert New...** – this brings up the *Edit Kit* dialog box

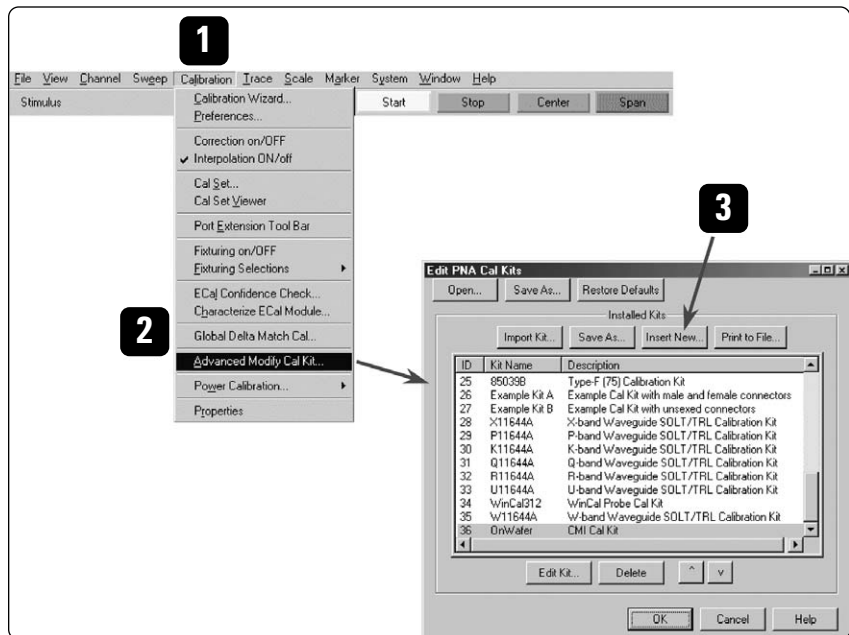

Figure 5. Creating a new calibration kit for probing.

Figure 6: Connector definition

4. Enter *Kit Name* and *Kit Description*
5. Click **Add or Edit** (located near the middle of the dialog box) to add connectors to this calibration kit – this brings up the *Add or Edit Connector* dialog box

In order to maximize the benefits of the minimum thru approach (only three thrus, not six, are needed to achieve a full 4-port calibration), it is best to set up a calibration kit with two probes (for example, “probe 1” and “probe 2”, or “male” and “female”), and then assign the ports such that it offers the PNA-L the easiest way to execute minimum thru. See Figure 6a for test port assignment. The actual calibration sequence will then be determined by the instrument, via the Calibration Wizard.

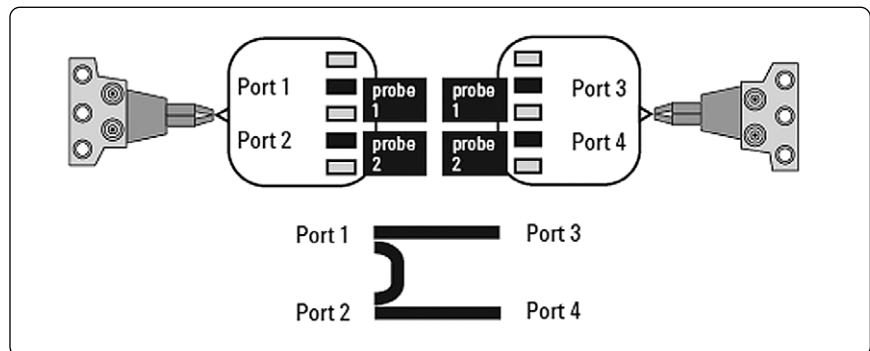
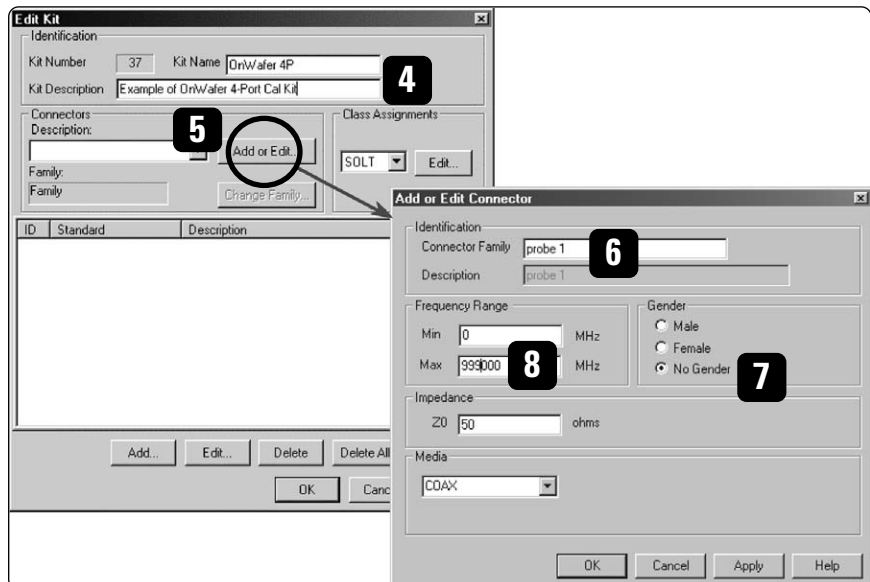

Figure 6a. Assigning test ports as either probe 1 or probe 2 offers the PNA-L the most efficient way of executing minimum thru. This example allows the PNA-L to maximize the number of straight thrus and minimize the number of non-straight ones.

6. Enter *Connector Family* – “probe 1” was typed in here
7. Select **No Gender** for connector *Gender*
8. Double check to make sure *Max Frequency Range* is above maximum frequency range of the instrument, for example, 999000 MHz, then click **OK**

Figure 6b. Creating a new calibration kit for probing: Connector definition.



Each standard (open, short, load and thru) will be defined with two probes, described here under Connector Family. They are identified as “probe 1” and “probe 2”.

As such, repeat steps 5 through 8, this time, enter “probe 2” for Connector Family (Figure 6c, left).

At this point, you should have two probes defined under Connectors, and they are “probe 1” and “probe 2” (Figure 6c, right).

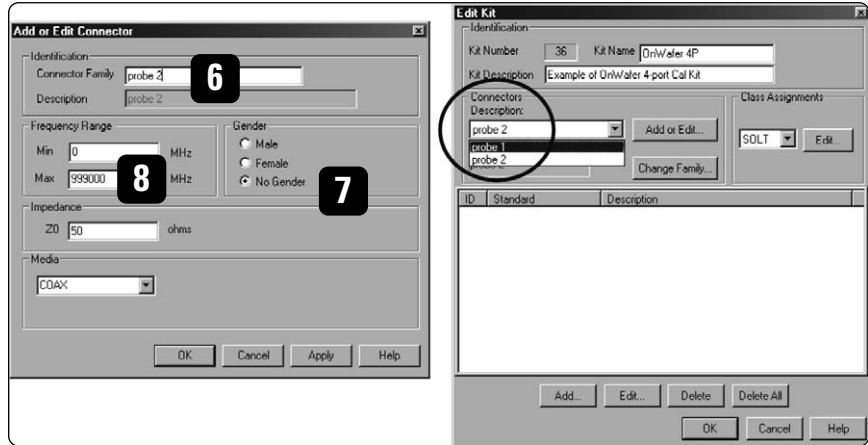

Figure 6c. Repeating steps 5 through 8 with “probe 2”.

Figure 7: Defining OPEN

9. Click **Add** (located near the bottom of the dialog box) – this brings up the *Add Standard* dialog box
10. Select **OPEN**, then click **OK** – this brings up the *Opens* dialog box
11. Modify *Label* to read “OPEN 1”
12. Under *Connector*, select “probe 1”
13. Enter the **C0** value, then click **OK** – each ISS (Impedance Standard Substrate) often comes with its own Calibration Coefficients. These values may differ depending on the configuration and pitch of the probes. Typical parameters that come with each ISS include
 - Copen (the capacitance term for the Open standard)
 - Lshort (the inductance term for the Short standard)
 - Lterm (the inductance term for the Load standard)

For more details regarding ISS and its coefficients, please contact Cascade Microtech at www.cmicro.com.

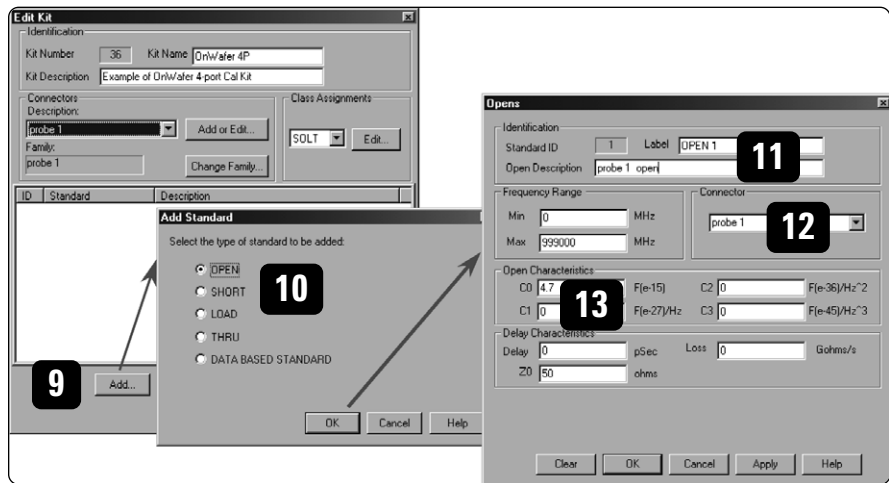

Figure 7a. Creating a new calibration kit for probing: Defining OPEN.

- Repeat steps 9 through 13. This time,
- enter “OPEN 2” for *Label* (step 11)
 - select “probe 2” under *Connector* (step 12)

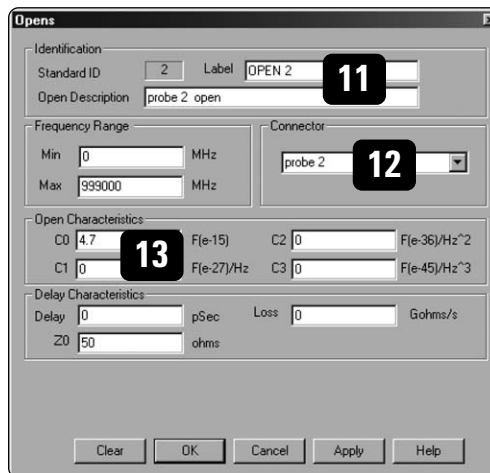

Figure 7b. Changing to “OPEN 2” and “probe 2”.

Figure 8: Defining SHORT

14. Click **Add** (located near the bottom of the *Edit Kit* dialog page) - this brings up the *Add Standard* dialog box
15. Select **SHORT**, then click **OK** - this brings up the *Shorts* dialog box
16. Modify *Label* to read "SHORT 1"
17. Under *Connector*, select "probe 1"
18. Enter the **L0** (Lshort) value, then click **OK**

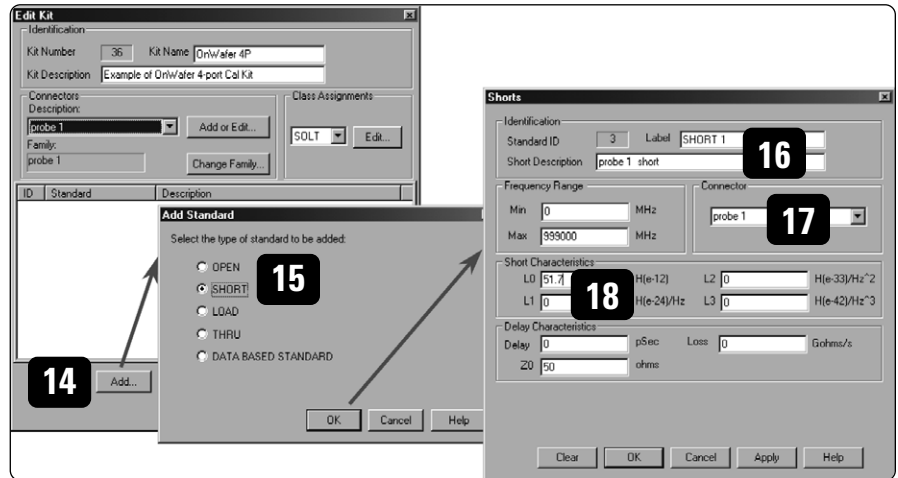

Figure 8a. Creating a new calibration kit for probing: Defining SHORT.

- Repeat steps 14 through 18. This time,
- enter "SHORT 2" for *Label* (step 16)
 - select "probe 2" under *Connector* (step 17)

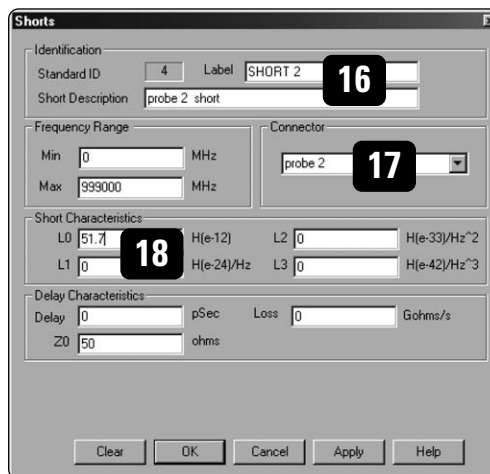

Figure 8b. Changing to "SHORT 2" and "probe 2".

Figure 9: Defining LOAD

19. Click **Add** (located near the bottom of the *Edit Kit* dialog page) – this brings up the *Add Standard* dialog box
20. Select **LOAD**, then click **OK** – this brings up the *Loads* dialog box
21. Modify *Label* to read “LOAD 1”
22. Under *Connector*, select “probe 1”
23. Enter the following values (because the *Loads* dialog page does not have an entry for the *Lterm*):
 - specify a high impedance for **Z0**, enter a value of 500 ohms
 - enter a value for **Delay** that is derived from $L/500$, where *L* is the value of *Lterm* as provided with the ISS.Then click **OK**.

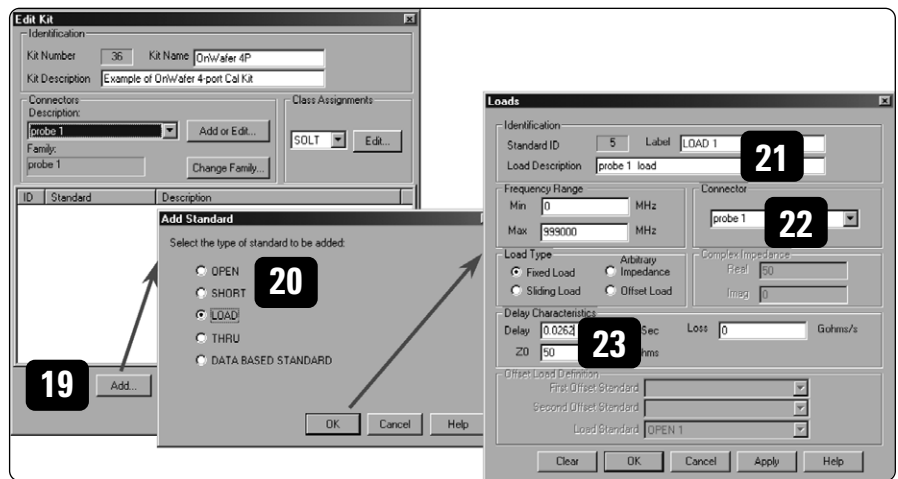

Figure 9a. Creating a new calibration kit for probing: Defining LOAD.

- Repeat steps 19 through 23. This time,
- enter “LOAD 2” for *Label* (step 21)
 - select “probe 2” under *Connector* (step 22)

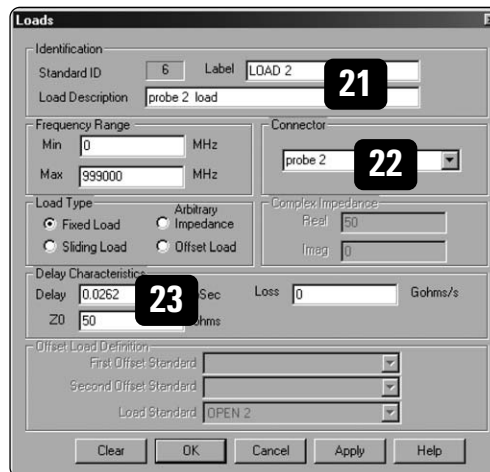

Figure 9b. Changing to “LOAD 2” and “probe 2”.

Figure 10: Defining THRU

24. Click **Add** (located near the bottom of the *Edit Kit* dialog page) – this brings up the *Add Standard* dialog box
 25. Select **THRU**, then click **OK** – this brings up the *Thru/Line/Adapter* dialog box
- The kit, as defined, allows one of the simplest 4-port on-wafer calibrations possible. Although the ISS has several thru lines (“straight thru”, “loop-back thru”, and “cross thru”), only two thru standards need to be defined. Using the configuration shown in Figure 6a, the two thru standards are best “straight thrus”. For this document, one thru will have two “probe 1” as *Connectors* and the other will have two “probe 2” as *Connectors*.
26. Modify *Label* to read “THRU 1”
 27. Under *Connectors*, select “probe 1” for both ports
 28. Enter the value for Delay as provided with the ISS, then click OK.

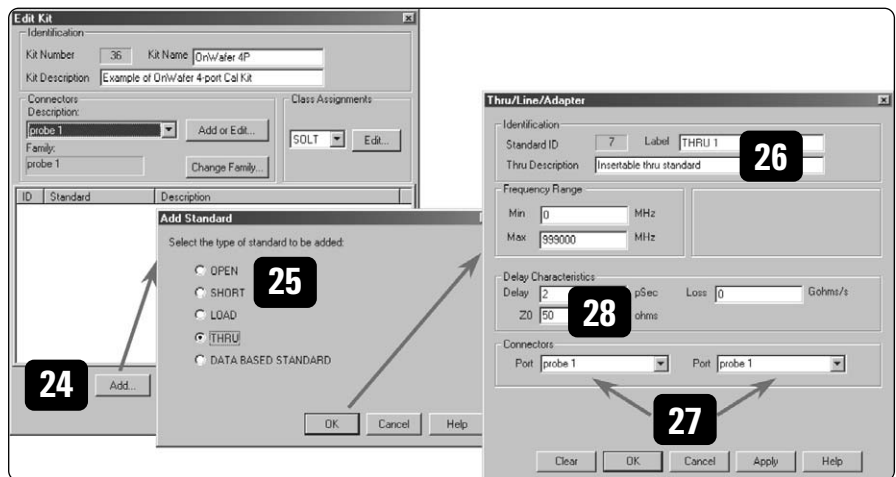

Figure 10a. Creating a new calibration kit for probing: Defining THRU standards.

- Repeat steps 24 through 28. This time,
- enter “THRU 2” for *Label* (step 26)
 - select “probe 2” under *Connectors* for both ports (step 27)

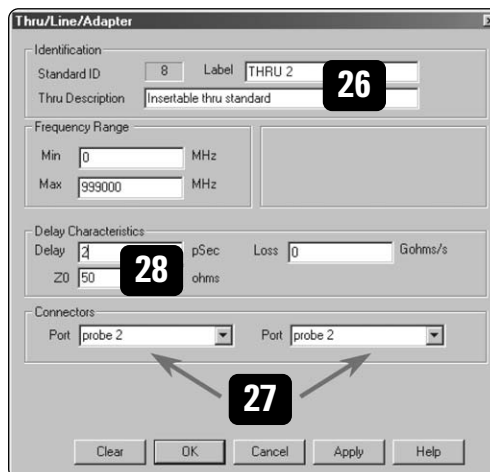

Figure 10b. Changing to “THRU 2” and “probe 2”.

Figure 11:

29. With the Thru standards added, the calibration kit is now complete. Click **OK**.

30. The calibration kit is now ready for use, as shown here in the Cal Kit list.

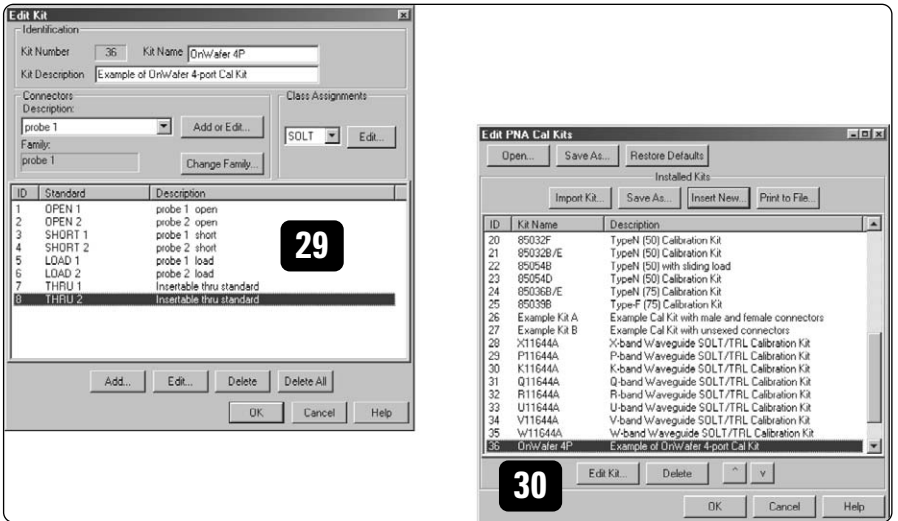

Figure 11. Creating a new calibration kit for probing: Complete.

Step 2. Perform the SOLT (Short-Open-Load-Thru) calibration

The PNA-L can perform 4-port calibrations with either SmartCal (Guided calibration) or an Electronic Calibration (ECal) module; but is not available with Unguided calibration. Since ECal modules are not applicable for on-wafer, we will use SmartCal, a calibration process in which the steps are guided by the instrument.

For 4-port calibrations, performing SOLT with Unknown Thru yields the best accuracy with the least complexity. Using the port assignment of Figure 6a, the minimum three thru paths to be measured can be the following:

Thru #1	ports 1 – 2	Unknown Thru
Thru #2	ports 1 – 3	Defined Thru
Thru #3	ports 2 – 4	Defined Thru

This way, the two Defined Thru paths measured are each a “straight thru,” and we use Unknown Thru to characterize the non-straight thru which in turn can yield better calibrated results.

To perform a full 4-port calibration, simply follow the boxed numbers in each of the figures shown below (Figures 12 through 16).

Figure 12:

1. Click **Calibration**
2. Select **Calibration Wizard...** – this brings up the *Calibration Wizard: Begin Calibration* dialog box
3. Select “**SmartCal (GUIDED Calibration): Use Mechanical Standards**”
4. Click **Next >** – this brings up the *Select Guided Calibration Type (Mechanical Standards)* dialog box
5. Under *Cal Type Selection*, make sure “**4 Port Cal**” is selected
6. Click **Next >** – this brings up the *Guided Calibration: Select DUT Connectors and Cal Kits* dialog box

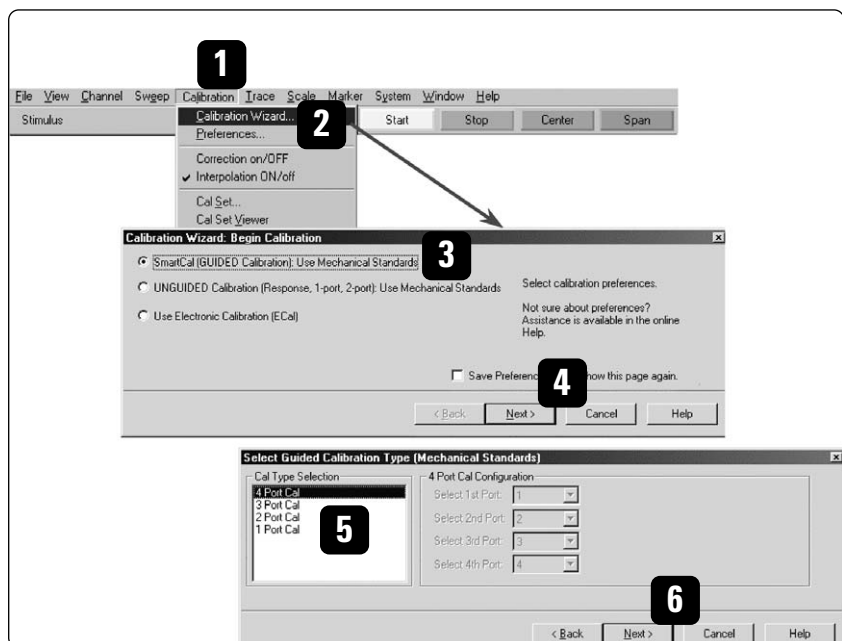

Figure 12. Begin calibration.

Figure 13:

7. Under *Connectors*, using the dropdown menu, select “**probe 1**” for ports 1 and 3, and select “**probe 2**” for ports 2 and 4 (as shown in Figure 6a).
8. This is the view one can expect after repeating step 7 for all four DUT Ports.
9. Once the connector has been chosen (steps 7 & 8), the associated *Cal Kits* will appear. Since there is only one calibration kit defined with *Connectors of Probe 1 and Probe 2, OnWafer 4P* will automatically appear under *Cal Kits*. If you have more than one calibration kit defined with the same connector, then you would need to select the desired cal kit for this calibration via the dropdown menu.
10. Select “**Modify Cal**” by clicking on the box. You must select this in order to be able to choose the Thru standard of your choice for each path.
11. Click **Next >** – this brings up the *Modify Cal* dialog box
12. A minimum of three thru paths are needed to achieve a full 4-port SOLT calibration. This example shows the thru paths of **1-2, 1-3, and 2-4** (column on the left); and they were chosen primarily for convenience. (A total of all six thru paths can also be selected, but it is not necessary for the full 4-port SOLT calibration. Additional thru paths can be enabled on the right side.)
13. Under *Thru Cal Method*, one must use the dropdown menu to select the method of choice. Available choices include “Defined Thru,” “Unknown Thru,” and “Adapter Removal.” Default shows Defined Thru. Choose **Defined Thru** for the “straight thru” paths; these include paths 1-3 and 2-4. For the “loop-back thru,” choose **Unknown Thru**; this includes path 1-2.
 - “Defined Thru” – applicable when used with a pre-defined adapter because the calibration process will apply the adapter information supplied in the definition. Delay value of the adapter must be reasonably close to the actual value (± 90 degrees, $\pm 1/4 \lambda$); otherwise, phase could be 180 degrees out.
 - “Unknown Thru” – ideal for non-straight or non-insertable thru, this must be a passive device where its forward and reverse characteristics are the same; as such, it is also referred to as “reciprocal thru.” The calibration process will measure the unknown passive device, determine its delay value, and then apply it in order to complete the calibration.
 - “Adapter Removal” – applicable when used with an unknown adapter because the calibration process will attempt to characterize the adapter before its effects are removed.

14. Click **Next >**

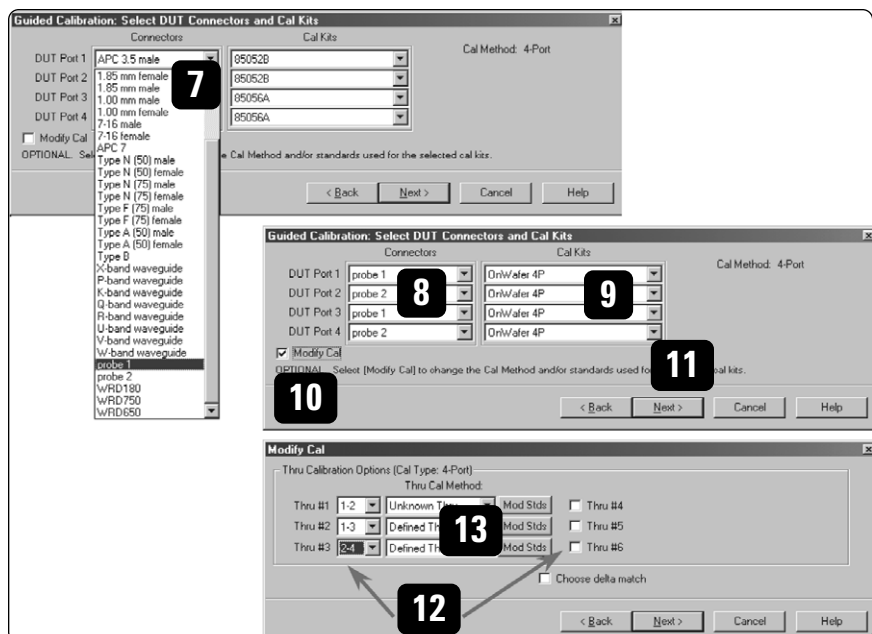

Figure 13. Select Connectors, Cal Kits, and Thru paths.

At this point, you should see the dialog box showing “Guided Calibration Step 1 of 15,” which is the beginning of the calibration.

Using Guided Calibration, the network analyzer will step the user through 15 steps (as shown in part (a) of Table 1), allowing the user to calibrate one port at a time. For each test port, the instrument steps the user through three standards (Open, Short, and Load) before advancing to the next test port. This approach is optimized for coaxial calibration, but not for probing. To be efficient in probing, a better approach would be to minimize the number of touchdowns, while maximizing the number of measurements possible for each touchdown. Such a scenario would only require seven touchdowns instead of 13 in order to complete a full 4-port SOLT calibration. To measure the standards in a different order than suggested by the Guided Calibration process, click the **Next** > softkey to skip standards (for example, to measure all the Opens at one time, as shown in part (b) of Table 1), and then click the < **Back** softkey to return to standards that have been skipped previously (for example, the Shorts and the Loads). Continue to move back and forth until all the necessary steps have been measured.

Table 1. Steps as Guided by the PNA-L (a) and sequence to be measured to minimize the number of probe touchdowns (b).

(a) Steps as guided by the PNA-L:

Step 1 of 15	Port 1 OPEN 1
Step 2 of 15	Port 1 SHORT 1
Step 3 of 15	Port 1 LOAD 1
Step 4 of 15	Port 2 OPEN 2
Step 5 of 15	Port 2 SHORT 2
Step 6 of 15	Port 2 LOAD 2
Step 7 of 15	Port 1 ADAPTER Port 2 ← this is the Unknown Thru
Step 8 of 15	Port 3 OPEN 1
Step 9 of 15	Port 3 SHORT 1
Step 10 of 15	Port 3 LOAD 1
Step 11 of 15	Port 1 THRU 1 Port 3
Step 12 of 15	Port 4 OPEN 2
Step 13 of 15	Port 4 SHORT 2
Step 14 of 15	Port 4 LOAD 2
Step 15 of 15	Port 2 THRU 2 Port 4

(b) An example of sequence to be measured to minimize the number of touchdowns:

Port 1 OPEN 1
Port 2 OPEN 2
Port 3 OPEN 1
Port 4 OPEN 2
Port 4 SHORT 2
Port 3 SHORT 1
Port 2 SHORT 2
Port 1 SHORT 1
Port 1 LOAD 1
Port 2 LOAD 2
Port 3 LOAD 1
Port 4 LOAD 2
Port 2 THRU 2 Port 4
Port 1 THRU 1 Port 3
Port 1 ADAPTER Port 2 ← this is the Unknown Thru

Throughout the calibration process, one sees the “**Guided Calibration Step**” shown on the upper left corner of the dialog box (Figure 14), the **Measure** button is on the right, and the < **Back** and **Next** > buttons are toward the bottom. Once a standard has been measured, a green “*check*” symbol appears above the **ReMeasure** button which is located at the exact spot where the **Measure** button used to be. After all the standards have been measured, a green **Done** button will appear below the **ReMeasure** button. You can always go back to re-measure any standard before pressing the **Done** key. At this point, one can finish the calibration by simply clicking **Done**, or choose to re-measure another standard as needed.

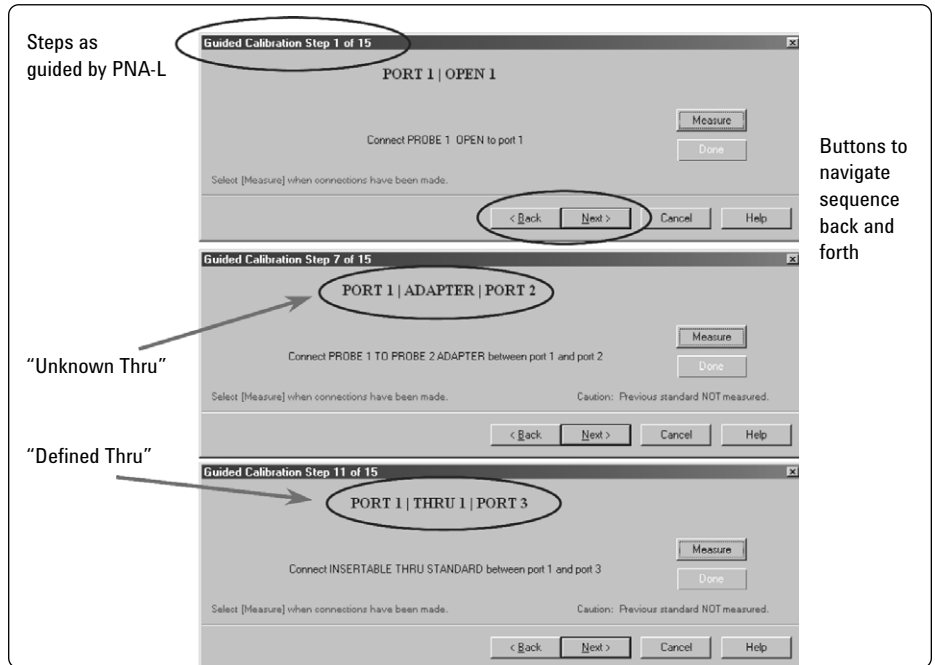

Figure 14. Samples of screens throughout the calibration process.

Once **Done** has been selected, the calibration is finished and it is then turned on with **C 4-P** appearing on the status bar (located at the bottom of the display) to indicate that the 4-port error-correction is now active.

Conclusion

The 4-port PNA-L (N5230A Opt.x4x) network analyzer can be used for manual calibration of on-wafer, or any non-coaxial applications. In fact, the steps outlined here can be used for any calibration process where the user needs to create their own calibration kit and follow their own sequence in order to minimize the number of connections or touchdowns (in the case of wafer probing).

Web Resources

For additional product information and application literature, visit our Web sites:

PNA Network Analyzers:
www.agilent.com/find/pna

Electronic Calibration (ECal) modules:
www.agilent.com/find/ecal

Test and measurement accessories:
www.agilent.com/find/accessories

RF and microwave network analysis and impedance probing
www.agilent.com/find/probingrf

Agilent Channel Partner

Cascade Microtech, Inc.
www.cmicro.com

Agilent Email Updates

www.agilent.com/find/emailupdates
Get the latest information on the products and applications you select.

Agilent Direct

www.agilent.com/find/agilentdirect
Quickly choose and use your test equipment solutions with confidence.



www.agilent.com/find/open

Agilent Open simplifies the process of connecting and programming test systems to help engineers design, validate and manufacture electronic products. Agilent offers open connectivity for a broad range of system-ready instruments, open industry software, PC-standard I/O and global support, which are combined to more easily integrate test system development.

Remove all doubt

Our repair and calibration services will get your equipment back to you, performing like new, when promised. You will get full value out of your Agilent equipment throughout its lifetime. Your equipment will be serviced by Agilent-trained technicians using the latest factory calibration procedures, automated repair diagnostics and genuine parts. You will always have the utmost confidence in your measurements.

Agilent offers a wide range of additional expert test and measurement services for your equipment, including initial start-up assistance onsite education and training, as well as design, system integration, and project management.

For more information on repair and calibration services, go to

www.agilent.com/find/removealldoubt

www.agilent.com

For more information on Agilent Technologies' products, applications or services, please contact your local Agilent office. The complete list is available at:

www.agilent.com/find/contactus

Phone or Fax

United States:
(tel) 800 829 4444
(fax) 800 829 4433

Korea:
(tel) (080) 769 0800
(fax) (080) 769 0900

Canada:
(tel) 877 894 4414
(fax) 800 746 4866

Latin America:
(tel) (305) 269 7500

China:
(tel) 800 810 0189
(fax) 800 820 2816

Taiwan:
(tel) 0800 047 866
(fax) 0800 286 331

Europe:
(tel) 31 20 547 2111

Other Asia Pacific Countries:
(tel) (65) 6375 8100
(fax) (65) 6755 0042

Japan:
(tel) (81) 426 56 7832
(fax) (81) 426 56 7840

Email:
tm_ap@agilent.com
Revised: 09/14/06

Product specifications and descriptions in this document subject to change without notice.

© Agilent Technologies, Inc. 2005, 2006
Printed in USA, October 17, 2006
5989-2287EN



Agilent Technologies