

Stacked LED Technology Enables Highly Integrated Optocouplers

White Paper

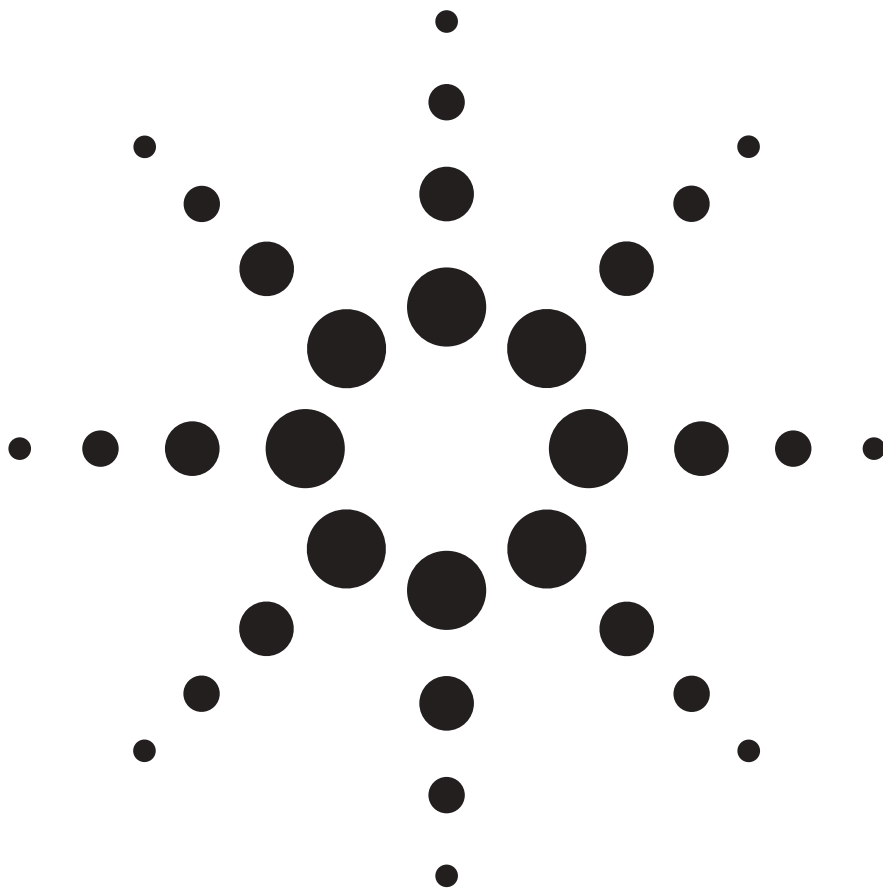

By Theng-Hui Kek and Leonard Tan

Agilent Technologies
Semiconductor Products Group
Isolation Products Division

Introduction

Optocouplers are widely used in providing galvanic isolation because of their true isolation characteristics. The heart of a modern optocoupler is an input infrared-emitting LED and an output photodetector, separated by a light transmissive medium, that can also act as an insulation layer. Or an additional light transmissive dielectric layer can be added to provide insulation. The photodetector can be a phototransistor, a photodiode with a transistor, or an integrated detector/logic integrated circuit. Most optocouplers are certified to the basic safety standards as outlined by UL1577, CSA and IEC/DIN EN/EN 60747-5-2.

In some applications, it is very desirable to increase the number of optocouplers in a single package in order to optimize manufacturing costs and save space on printed circuit boards. Multi-channel optocoupler configurations will eliminate the many single- or dual-channel optocouplers used on many customers' boards. Bi-directionality of the multi-channel optocouplers will help to simplify the PCB routing.

Previous engineering attempts to integrate more than two optocouplers into a single package have proved to be a challenge. The limitation is in the current hybrid manufacturing process of putting several LEDs and IC devices in a monolithic package. Some of the difficulties include:

- a. An increased number of manufacturing steps.
- b. Light leakage/crosstalk between optocoupler channels
- c. Problems with increasing the number of IC chips due to difficulties with isolation material placement
- d. Package size could not be reduced further due to the needed geometry.

The development of a new manufacturing process called Stacked LED Technology—stacking LED die directly on a silicon IC substrate—helps to enable higher integration in monolithic IC packaging. This paper will introduce Stacked LED Technology and describe its unique components and benefits.

Optocoupler Manufacturing Technologies

Optocouplers operate based on the light coupling between the LED and the photodetector IC, while providing high voltage insulation, ranging from 2.5 kV to 6 kV, between the emitter and detector. The degree of light coupling depends on the formation of the lightguide. The insulation will either be provided by the lightguide material itself or via additional light transmissive dielectric material. In all cases, the arrangement of the LED, lightguide material, dielectric material and IC will have a direct impact on the performance of light coupling and high voltage insulation.

In general, packaging an optocoupler is similar to packaging a conventional integrated circuit except for the unique process steps and materials needed to form the lightguide and meet the high voltage insulation. The following table illustrates various optocoupler manufacturing technologies, and describes the materials, processes, and constraints of each.

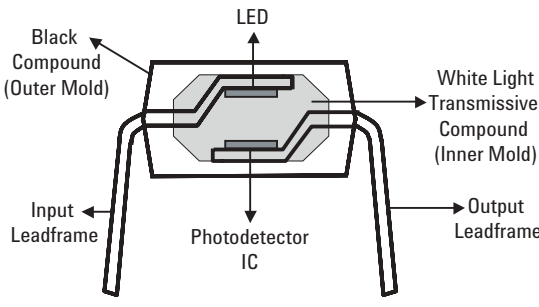
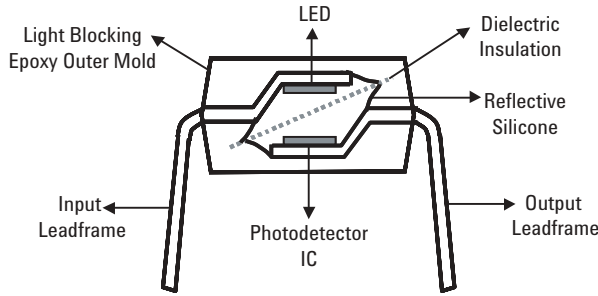
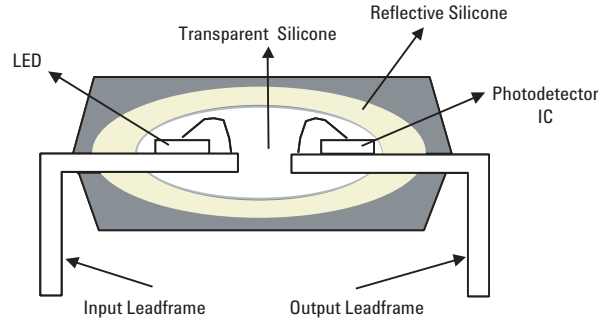
Technology	Materials / Processes	Constraints
<p>Double Mold</p> 	<p>Materials</p> <ul style="list-style-type: none"> Two leadframes (LED and IC) White light-transmissive compound <p>Processes</p> <ul style="list-style-type: none"> Combine to make LED light-emitting area face IC Mold white compound. Remove white compound flash 	<p>Package height limitation due to the needed spacing between LED and IC</p> <p>Package height limitation due to the thickness between the compound materials</p> <p>Crosstalk might occur if ICs are packed too close. This is because the white compound permits light transmission</p> <p>High integration is difficult due to double mold process and the excessive use of compound materials</p> <p>Alignment of LED and IC is critical for light coupling</p> <p>The gap between the IC and LED is critical for light coupling</p>
<p>Dielectric placement</p> 	<p>Materials</p> <ul style="list-style-type: none"> Two leadframes (LED and IC) Reflective silicone Dielectric material <p>Processes</p> <ul style="list-style-type: none"> Attachment with silicone and dielectric material Combine with silicone 	<p>Customized machines needed for dielectric placement and combining processes</p> <p>Package height limitation due to dielectric material geometry</p> <p>High integration is difficult due to dielectric placement</p> <p>Alignment of LED and IC is critical for light coupling</p> <p>The gap between the IC and LED is critical for light coupling</p>
<p>Planar</p> 	<p>Materials</p> <ul style="list-style-type: none"> One leadframe Reflective silicone Optional white reflective coating Special white molding compound <p>Processes</p> <ul style="list-style-type: none"> Clear silicone dome formation Optional white reflective coating 	<p>Customized machines needed for dispensing clear silicone and white reflective coating</p> <p>Special white compound</p> <p>High integration is difficult due to the size of the silicone dome</p> <p>Light coupling might not be efficient, as it is indirect. The LED and IC are in the same plane and hence the light coupling is through reflection.</p>

Stacked LED Technology

The diagram below illustrates a cross-sectional view of the Stacked LED technology. The photodiode chip comes with two transparent layers; SiO₂ passivation/insulation and light-transmissive polyimide. The LED is firmly attached to photodiode with a transparent connecting layer. Standard die attach process is used to make all the placements.

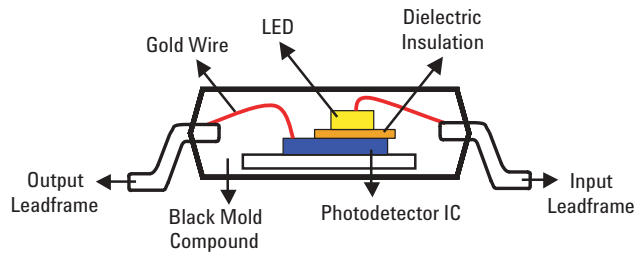
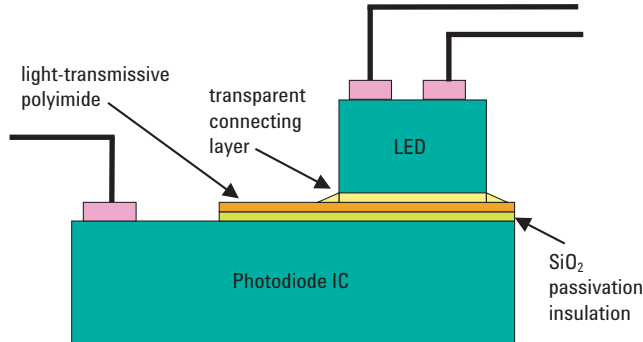

Stacked LED Technology Advantages

a. High integration

The Stacked LED technology greatly enhances packaging capabilities and flexibility by utilizing conventional IC assembly equipments. Essentially, an emitter-detector chip set can be inserted in any required integrated package.

b. Reduced process steps

The method requires fewer process steps and hence it is a more efficient manufacturing method.

c. Small and thin profile package

The total package height is now solely depended on the thickness of the combination of the IC, LED, the very thin polyimide and the bond wire height to the LED.

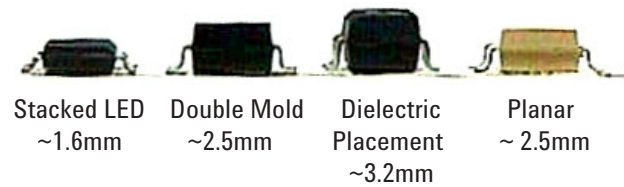

Innovative LED Design – Back Emission LED

Most LEDs used for optocouplers emit light on the same side as the metal contacts. The key enabler of Stacked LED technology was the development of Agilent’s Back Emission LED.

To enable stacking, the light needs to be emitted from the reverse side of the LED.

The below table illustrates the differences between the Standard LED and Stack LED.

Technology	Standard LED	Back Emission LED
Example		
Material	Light absorbing substrate	Transparent substrate
Unique properties	Light emission from top side metal only	Light emission from both top and reverse side
	Light extracted from top side for coupling with detector IC	Light extracted from reverse side for coupling with detector IC
	Metal contact pads on opposite sides of die	Both metal contact pads on same side
Benefits	Ease of LED design	Close coupling with detector IC possible
	Enable top emitting applications	Ability to stack LED on top of detector IC
		Reduce overall component thickness

Summary

Optocoupler comprises of LEDs and ICs. It works based on the light coupling between the LED and IC. Higher level of integration for cost and space saving has always been a key market trend. Attempts to integrate optical components and more silicon circuitries by various optocoupler suppliers have not been successful.

The successful development of Stacked LED Technology by Agilent Technologies has enabled highly integrated optocoupler. The new ACSL-6xx0 series, Multi-Channel and Bi-Directional, 15MBd Digital Logic Gate Optocouplers, are the first to leverage this leading edge technology to address the multi-channel and bi-directionality requirements of the digital isolation arena. Customers will benefit with lower system cost and better overall system performance.

[www.agilent.com/ semiconductors](http://www.agilent.com/semiconductors)

For product information and a complete list of distributors, please go to our web site.

For technical assistance call:

Americas/Canada: +1 (800) 235-0312
or (408) 654-8675

Europe: +49 (0) 6441 92460

China: 10800 650 0017

Hong Kong: (+65) 6756 2394

India, Australia, New Zealand: (+65) 6755 1939

Japan: (+81 3) 3335-8152(Domestic/International), or 0120-61-1280(Domestic Only)

Korea: (+65) 6755 1989

Singapore, Malaysia, Vietnam, Thailand, Philippines, Indonesia: (+65) 6755 2044

Taiwan: (+65) 6755 1843

Data subject to change.

Copyright © 2004 Agilent Technologies, Inc.

November 5, 2004

5989-1473EN



Agilent Technologies