

Feeling Comfortable with VXIbus

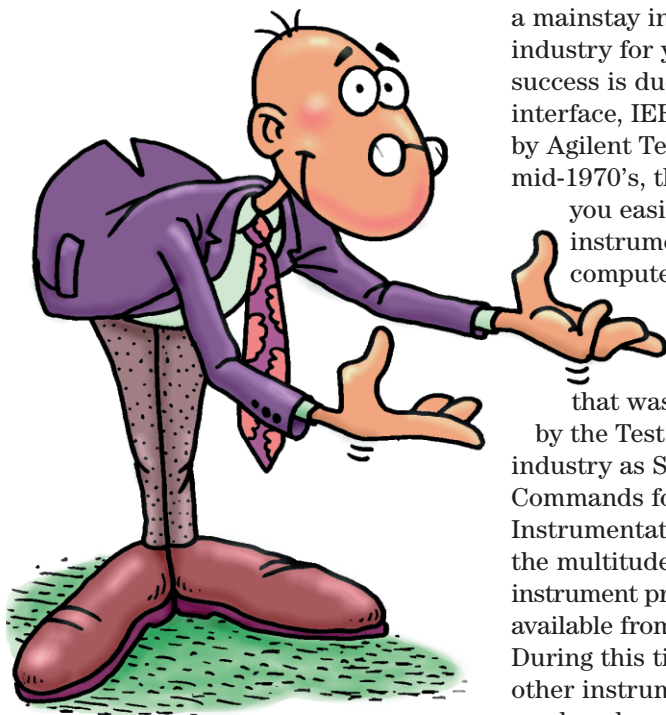

If you've been around electronics very long, you know that "rack and stack" instruments have been a mainstay in the electronics industry for years. Much of their success is due to a widely used interface, IEEE-488. Developed by Agilent Technologies in the mid-1970's, this interface allows you easily to connect your instruments using a remote computer. In the late 1980's, Agilent Technologies offered a standard instrument language that was quickly adopted by the Test and Measurement industry as SCPI - Standard Commands for Programmable Instrumentation - to eliminate the multitude of proprietary instrument programming languages available from instrument vendors. During this time, Agilent and other instrument manufacturers produced a growing number of proprietary GPIB modular instrument products. These instruments could be integrated into test systems to provide switching, measurements and signal source capabilities. However few of these modular products were compatible. The VXIbus standard addressed this problem of incompatibility. Because it changes the way we

think about electronic test, there's still some confusion about how to apply the VXIbus standard, how complex it is, and how it fits in with existing rack and stack instruments. With the success of the VXIbus standard, other standards -like *VXIplug&play* and SCPI - are emerging to improve the usefulness of VXIbus technology in electronic test.

In this booklet, we'll provide you with a basic understanding of VXIbus, SCPI, and *VXIplug&play* and explain some of the advantages of these standards. We will not tell you that they are the answer to every problem, but will show you how to integrate these modular products into your current test system. We'll also help you understand the tradeoffs in selecting various VXI devices. Please understand this is not a manual for any specific VXI instrument, but rather an introduction to overall VXI technology.

We're pleased to be a leader in VXIbus, SCPI, and *VXIplug&play* technologies. We think you'll see the advantages of these standards in your test system environment.

**With that in mind,
let's take a closer look.**



Agilent Technologies

Feeling Comfortable with VXIbus

CONTENTS

VXIbus: The Test and Measurement Standard	3
The History of VXIbus	3
Goals of the VXIbus Consortium	3
GPIB & VMEbus, The Foundation for VXI	4
What is GPIB?	4
What is VMEbus?	4
VXIbus: The Best of Both Worlds, and More!	5
Taking the Best from GPIB & VME	5
More Features of VXIbus Systems	6
SCPI: The Standardized Programming Language	7
VXIplug&play: The New Standard for Test and Measurement	8
What is VXIplug&play?	8
What does VXIplug&play Offer?	8
What Do VXIbus, SCPI, and VXIplug&play Mean to You?	9
Open Standards	9
Higher Test System Throughput	10
True Upgrade Path	11
Easy Integration with Rack & Stack	12
Smaller Test Systems	12
Access to Switching Modules	12
Long-Term Software Protection	13
Multi-Vendor Interoperability	13
The VXIbus Standard: More Details	14
Instrumentation Environment	14
Module Sizes	14
Connectors and Buses	15
Power, Cooling, and Interference	16
VXIbus Devices and Communication	16
What are Devices?	16
Register-Based Devices	17
Message-Based Devices	18
More on Communication	19
GPIB & LAN	19
External Interfaces	19
Embedded vs. External Computers	20
SCPI: More Details	21
VXIplug&play: More Details	22
How does VXIplug&play Work?	22
Frameworks	22
Instrument Drivers	23
VISA I/O Library	24
Putting It All Together	25
What has Agilent Technologies Done to Improve VXI Technology?	26
Summary	27

VXIbus: The Test and Measurement Standard

The History of VXIbus

During the late 1970's and 1980's, numerous electronic instrument companies were producing their own proprietary cardcage systems. The manufacturers recognized the advantages of cardcage and IAC (Instrument-On-A-Card) systems, but they were using vastly different approaches. At the same time, the US Air Force created a program to design a single IAC standard that would result in substantially smaller electronic equipment.

In April 1987, five companies - Agilent Technologies, Tektronix, Colorado Data Systems, Racal-Dana, and Wavetek - started discussions aimed at creating an IAC standard that would benefit both the commercial and military test communities. The companies formed the "VXIbus Consortium" and met for three months of intense technical discussions. An initial draft, the VXIbus System Specification, was released on July 14, 1987.

Like most new things, the specification has undergone several changes. Revision 1.3 was released in 1989. The specification was submitted to the IEEE and was adopted as the IEEE-1155 Standard in 1992. In addition, the U.S. Air Force has incorporated the VXIbus specification into its MATE (Modular Automated Test Equipment) program. The VXIbus has continued to evolve, with Revision 2.0 released in 1998.



Instrument-On-A-Card Systems

Goals of the VXIbus Consortium

The members of the VXIbus Consortium had a lot of experience with IAC systems. They understood their benefits - increased test throughput, smaller instruments, reduced cost, etc. They wanted to create a technically sound standard that would bring IAC systems into the "next generation." That would free up design engineers to do what they do best - bring new technologies to market. The result would be products of greater innovation, quality and diversity.



GPIB and VMEbus: The Foundation for VXIbus

The Consortium members recognized Agilent Technologies' GPIB (IEEE-488) and VMEbus as the two most popular standards for instrumentation. They decided to take the best from these standards and add more features to create the best possible IAC standard.

What is GPIB?

In the early 1970's, Agilent Technologies invented an 8-bit parallel interface- GPIB. It allowed rack and stack instruments to communicate with each other and with a host computer. In 1975, GPIB was adopted by the IEEE as standard IEEE-488. Today, it is the leading interface used in automated test systems built on individual instruments. It is simple, flexible, and used by nearly all instrument manufacturers.

GPIB is a widespread standard- it allows you to connect instruments from several manufacturers to a host computer (controller), and thus build an automated, integrated test system. Normally, you don't have to worry about how information is passed between the devices. Your only concern is the content of the information, whether it be ASCII or binary instructions to an instrument, or ASCII or binary results from an instrument.

A good way to think of GPIB instruments is as electronic devices that operate by themselves. They have communication intelligence,

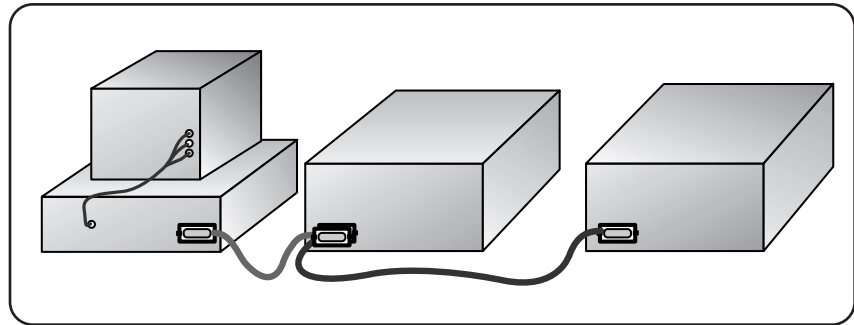

Figure 1. A GPIB System: Ease of Use, Ease of Integration

and may also perform sophisticated data capture and analysis. An example is a digital multimeter. Using GPIB, you can send the multimeter a sequence of ASCII strings that instruct it to take a burst of 1000 readings. You may also send it commands telling it to calculate statistical functions like minimum, maximum, and standard deviation on the readings. Then you can bring only those resulting values back to the computer.

One limitation of GPIB has been a maximum data transfer rate of about 1 Mbyte per second. This is usually not a problem, since most applications are limited by the speed of the measurement circuits, or by the switch closure and settling time required to route signals. However, it can become a problem with high-speed digitizing, digital inputs/outputs, or if large amounts of data must be transferred from an instrument to the computer for specialized processing. Furthermore, the GPIB protocol limits the transfer speed to that of the slowest device on the bus.

What is VMEbus?

While GPIB is the most popular electronic instrument interface, VMEbus is widely used in micro-computer systems. The VMEbus specification was released in August 1982, and approved by IEEE and ANSI in 1987.

You can think of VMEbus as an interface with two components- mechanical and logical. The mechanical portion specifies the physical dimensions of plug-in boards, backplanes, subracks, etc. (The form factor of the plug-in boards is commonly known as the Eurocard format.) The logical portion of the interface describes how functional modules (in this case, plug-in cards) communicate with each other. A major objective of VMEbus is to allow communication between two devices without disturbing the internal activities of other devices in the system. VMEbus systems can have multiple microprocessors on the same backplane.

VXIbus: The Best of Both Worlds, and More!

One strength of VMEbus is that it allows high-speed communication between devices (which we use interchangeably here with “modules”). The specification was originally intended for microcomputer systems. As instrument speeds increased and printed circuit board sizes decreased, interest grew in bringing electronic instruments into the system. However, this brought out two shortcomings of VMEbus: the electrical environment, designed for digital communication, is too “noisy” for precise analog measurements, and the programming needed for high-speed communication has to be done with low-level register reads and writes.

VXIbus: The Best of Both Worlds, and More!

Members of the VXIbus Consortium realized that for the VXIbus standard to be successful, it must answer two major challenges in instrumentation: communication speed and integration. The GPIB and VMEbus specifications held the answers to both these problems. A third challenge solved by the Consortium was to devise a well-defined environment in which different vendors’ products can operate together properly.

The result is the VXIbus (VMEbus Extensions for Instrumentation)

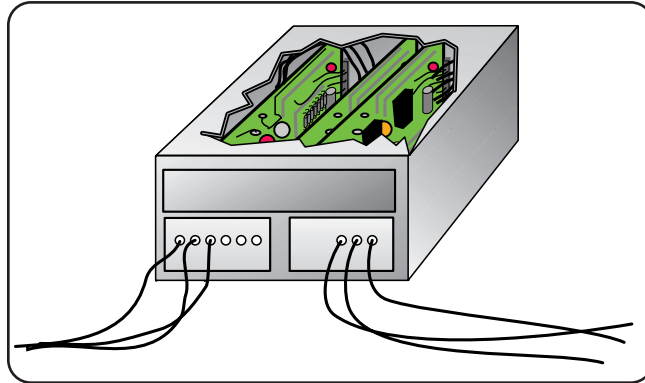

Figure 2. A VMEbus System: Potential for High Speed And Multiple Processors

Taking the Best from GPIB & VMEbus.

The VMEbus specification, originally designed for microcomputers, has a great potential for high-speed device-to-device communication. This can increase the throughput of your test system considerably. And GPIB is well known for its ease of integration, which helps you to build your test system faster. So the two main challenges- speed and integration- were answered. Although the GPIB and VMEbus standards have different bus communication styles, VXIbus defines two different devices to take advantage of these styles.

Remember that GPIB instruments are easy to use. You simply connect the cable and program the instruments in whatever language they require. In VXIbus systems, the counterpart to GPIB instruments are “Message-Based Devices.” They are easy to integrate into a system and communicate at a high level using ASCII characters. Like GPIB instruments, Message-Based Devices can contain significant intelligence and data processing capabilities. Like instruments on a GPIB bus,

however, Message-Based Register-Based Devices can be limited when it comes to high-speed data transfer.

The outstanding feature of VMEbus devices is that they can move data between themselves very fast. The VXIbus specification defines “Register-Based Devices” as the analog to VMEbus devices. These devices communicate at a lower, more basic level than Message-Based Devices and so can attain greater transfer speeds. Programming a Register-Based Device involves writing to and reading from individual registers on the device.

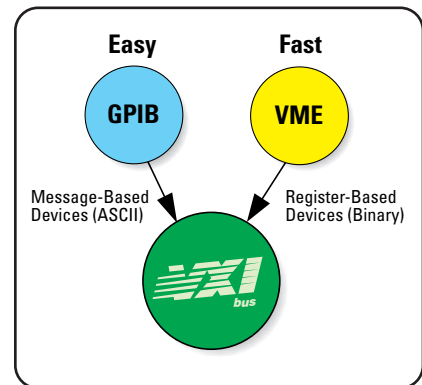

Figure 3. VXIbus: The Best of Two Worlds

More Features of VXIbus Systems.

The VXIbus Consortium fully defined the operating environment for VXIbus modules. All VXIbus mainframes must state how much power and cooling they provide. And all VXIbus modules must state how much power and cooling they require. Also, there are strict limits on how much conducted and radiated interference is allowed between modules. These parameters allow you to configure a workable system easily.

Two special functions must be performed in every VXIbus system. The first, Slot 0, takes care of backplane management. Slot 0 is a unique physical location in every VXIbus mainframe. Signals from this slot must include things like clock sources, arbitration for data movement across the backplane, etc. The module that goes into this slot must perform these hardware functions in addition to its normal functions. If you're familiar with VMEbus systems, you probably recognize that this is very similar to VME's "Slot 1 Device." The Slot 0 device relieves you of the burden of managing data flow across the backplane.

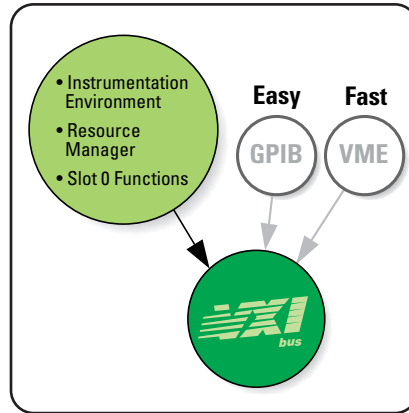

Figure 4. VXIbus Additional Features

The second special function in a VXIbus system is the Resource Manager. The best way to think of the Resource Manager is as a computer program. This program configures the modules for proper operation whenever the system is powered on or reset. This means that you can build your test system software from a known starting point. The Resource Manager is not involved with the VXIbus system once normal operation begins.

SCPI: the Standardized Programming Language

With the rapid growth of computer-controlled instruments, Agilent Technologies recognized the need for a common instrumentation language. Therefore, in the late 1980's, Agilent Technologies invented TMSL (Test and Measurement Systems Language) and offered to make it an open standard. TMSL itself was based on industry standards wherever possible, including IEEE-488.2 and IEEE-754. In April 1990, this standard was accepted by the industry, and renamed SCPI (Standard Commands for Programmable Instrumentation). You now have to learn only this single instrument programming language, regardless of whose digital multimeter (or other similar instrument) you purchase. With this standardized programming language for VXIbus instrumentation in place, you can reduce your test system programming time!

SCPI is now managed by a consortium of nine instrument manufacturers. Today, there are over a thousand instrument products using SCPI. For more about how SCPI works, see the **SCPI: More Details** section of this booklet.

VXIplug&play: The NEW Standard for Test and Measurement

VXIbus was a significant effort to standardize modular instrumentation. It provided an open environment where any vendor's modules would plug into any VXI mainframe. Users could expect the module to fit the slot size and be adequately powered and cooled. However, VXIbus didn't address the need to integrate a system that was truly vendor independent and easily usable. Wouldn't it be nice if there were a common look and feel, or a standard soft front panel for given instrument types from various vendors? Wouldn't it be great if you could develop your application program on a PC and execute it on a UNIX platform? Or, what about instrument drivers? An industry standard set of drivers would eliminate custom driver design issues. Agilent Technologies is an active member in the VXIplug&play System Alliance to address these challenges.

What is VXIplug&play?

VXIplug&play is a term indicating conformance to a new set of system-level standards, produced by the VXIplug&play Systems Alliance. Agilent Technologies joined the VXIplug&play Alliance in 1994 in support of the Alliance's charter: "to improve the effectiveness of VXI-based solutions by increasing ease-of-use and improving the interoperability of multi-vendor VXI systems." The goal of the Alliance is to achieve interoperability of mainframes, computers, instruments, and software through open, multi-vendor standards and practices. The Alliance consists of vendors actively involved with end-users to produce instrumentation systems that meet this goal. Additionally, the Alliance is open to all vendors and users as a forum for working together to make VXI technology easier to use.

Thanks to the work of the Alliance, VXIplug&play components integrate easily. The new standards apply to instrument drivers, soft front panels, installation packages, documentation, technical support, application development environments, as well as many other areas for instrument system integration. As with the VXIbus standard, revisions to VXIplug&play will continue to reduce your dependence on any single vendor and simplify your job of system design and implementation.

What does VXIplug&play offer?

VXIplug&play improves productivity, portability, and interoperability for both vendors and end-users.

- **Productivity**
Use soft front panels to operate and evaluate instrument operation within minutes.
- **Portability**
Communicate with instruments via any controller/computer interface supported by the VISA I/O library.
- **Interoperability**
Develop application programs portable across computer platforms and I/O interfaces. Add new programs without having to rewrite existing ones.

With vendors and end-users working together, the real needs of system integration continue to be analyzed, defined, and implemented. For more on the VXIplug&play standard, see the **VXIplug&play: More Details** section of this booklet.

What Do VXIbus, SCPI, and VXIplug&play Mean to you?

The VXIbus, SCPI, and *VXIplug&play* standards can improve your test system's speed and flexibility, lower your product "life cycle" cost, protect your investment, and provide a choice of vendors' products that will work together in your test system.

Open Standards

VXIbus, SCPI, and *VXIplug&play* are truly open standards. So far, over 200 different manufacturers have received identification codes from the VXIbus Consortium, and hundreds of different instruments are available. This multi-vendor environment ensures that your investment in VXIbus products will be protected long into the future. If one manufacturer's instrument becomes obsolete, a replacement should be available from another. Also, there will be many "niche" manufacturers willing to provide specialty modules- just as in the computer industry.

Because of the open standards, instrument manufacturers can provide VXI products with the benefits of standardized architecture, instrument programming language, and I/O communication. The backplane pinouts and communication techniques are already defined for you. Power and cooling capabilities are completely specified. Also, electrical interference limits have been set, so you know your module will have a "quiet" environment. The VXIbus specification defines all of these, and takes care of the hardware specifications for any VXI system. The *VXIplug&play* System

Alliance completes the standardization process with specifications for the operating system or "framework," instrument drivers, and I/O software. VXIbus and *VXIplug&play*, working together, give you all the tools and guidelines needed to successfully design a custom VXI-compatible module for a unique function, build a new VXI test system, or upgrade your existing system.

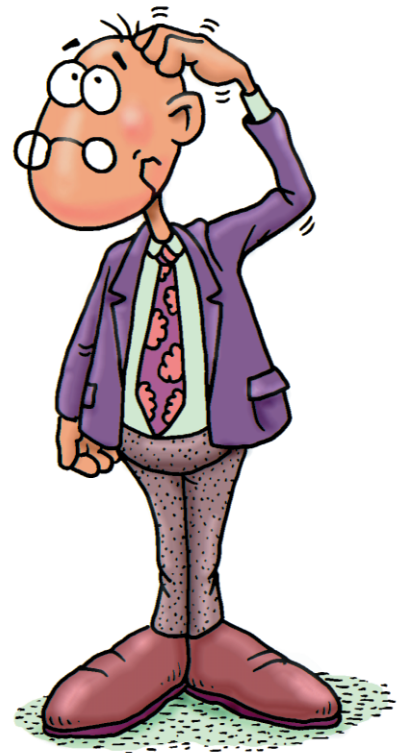

Higher Test System Throughput

Increased test system throughput gives you a great competitive edge by lowering your testing and manufacturing costs. The VXIbus backplane has a theoretical data transfer limit of 40 Mbytes per second. Normally, the backplane will not be a bottleneck for your data transfer. The not-so-obvious advantage of the VXIbus is its potential for distributed intelligence, which leads to increased system throughput. Because of its VMEbus background, VXIbus can deal with multiple microprocessors on the backplane existing within a shared memory architecture. Arbitrating data transfers on the backplane allows for a higher data bandwidth than any single device in the system can achieve. Multiple levels of priority allow critical processes to interrupt and use resources only when they're required.

How can this help you? Let's say you have an embedded computer that's transferring a large block of readings from a digitizer into the computer's memory over the data bus. Simultaneously, another instrument like a counter might be using the data bus to send a value to the controller every few milliseconds. At the same time, another intelligent device might be monitoring several channels of voltage and internally performing limit checks. If a condition goes out of limit, this device could request the data bus at a higher priority than the other devices, and send only the failure data to the computer for immediate action. Together, these multiple devices, with their different priorities, can more efficiently fill the data bus. This makes for higher overall system throughput.

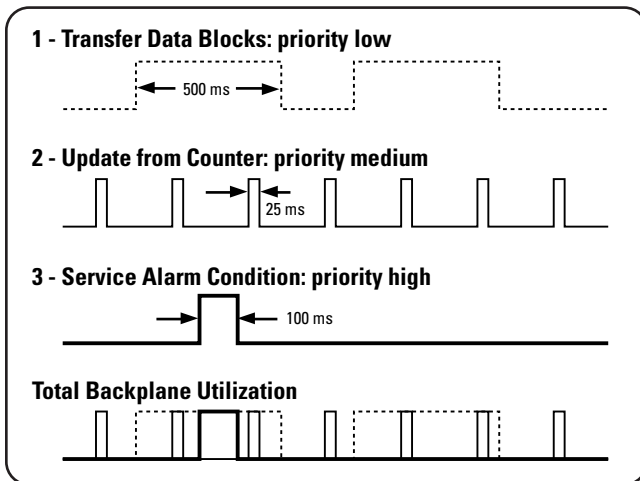

Figure 5. Different Priorities, Maximum Throughput

True Upgrade Path

Another great feature of the VXIbus is a true migration or upgrade path. This allows you to use your current hardware and software in future test systems. Suppose your current application is fairly simple: scan 15 channels of voltage, measure the frequency of two signals, and provide low-level power for a current loop. This application could be easily and inexpensively done by a system based on small VXIbus modules. Your testing needs may expand in the future so that you'll need more high-performance instruments such as a high-speed digitizer or signal generator. These instruments may only be available as larger and more complex VXIbus modules. But all your smaller VXIbus modules will easily fit right into the new, larger system! Also, VMEbus devices that you're currently using, or plan to use, can be integrated into a VXIbus system. Your imagination is the only limit on the size and complexity of your system.

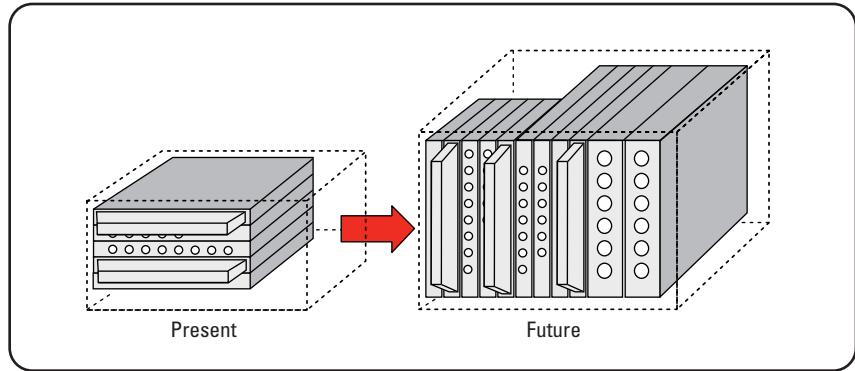

Figure 6. VXIbus: A True Upgrade Path

Easy Integration with Rack and Stack

VXIbus and *VXIplug&play* systems can coexist perfectly with GPIB test systems. You can use the resources from both without being limited to one type of system. In fact, many of your test systems probably will be a mix of VXIbus and non-VXI instruments. For example, a test system may need VXIbus to solve a throughput bottleneck, and also a very high accuracy measurement from a network analyzer that is available only as a standalone instrument.

Another common scenario might be a VXIbus mainframe full of instruments controlled by a computer. The computer might be embedded in the VXIbus mainframe or external to it. At the same time, this computer could easily control several large programmable power supplies via GPIB, and perhaps monitor transducers or data links via RS-232.

Both GPIB and non-VXI instruments can be programmed exactly like *VXIplug&play* instruments, by adapting *VXIplug&play* instrument driver technology and using SCPI commands with either the VISA I/O Library or Agilent SICL (Standard Instrument Control Library).

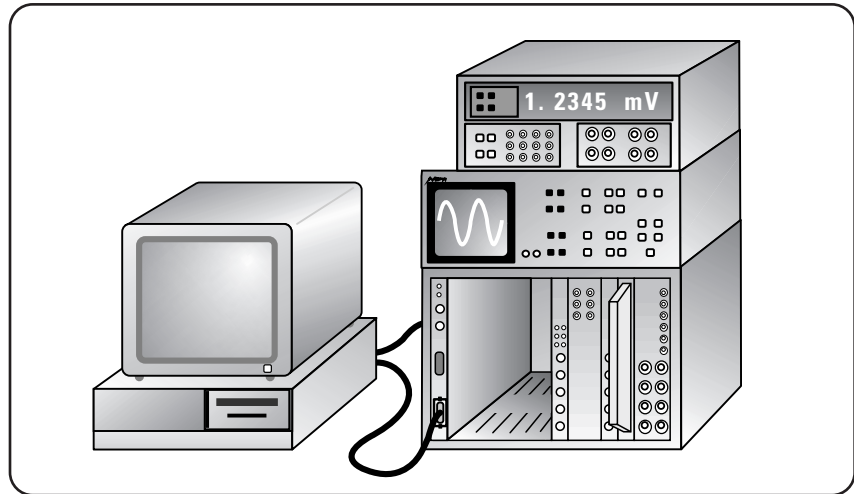

Figure 7. Mix and Match with VXIbus and Rack & Stack

Smaller Test Systems

Probably the most obvious advantage of VXIbus systems is the significant downsizing of test systems. Much of the downsizing results from using common power supplies and eliminating front panels. This benefit has been very important to military users due to their extremely large test systems, and continues to grow in the commercial world as devices increase in electronic content and complexity.

Access to Switching Modules

Many people are introduced to VXI because of their need for signal routing (switching). Almost every test application requires some sort of signal routing, and VXI offers many more choices than traditional rack and stack. As more instruments become available, the importance of VXI in testing continues to grow.

Long-Term Software Protection

VXIbus is an excellent solution to the problem of hardware compatibility- i.e., protecting your hardware investment. But software compatibility, software development productivity, and protecting your investment in software are equally important issues. In a lot of applications, the cost of test system software is actually greater than the cost of the hardware!

Development of the VXIbus specifications increased awareness of software incompatibility issues. SCPI (Standard Commands for Programmable Instrumentation) can help you protect your software investment with one standardized programming language for VXIbus instrumentation. For more information, see the **SCPI: More Details** section of this booklet.

Multi-Vendor Interoperability

VXIplug&play emerged not only to address software issues, but also to define standards at a complete system level. Successfully integrating a multi-vendor VXI system requires hardware working together at the electrical and mechanical level. The software used to control the hardware must also work together. In large, complex test systems, determining the “framework” or platform and then finding components that work together may be an integrator’s greatest challenge. *VXIplug&play* becomes an excellent solution for integrating your VXI system into a successful multi-vendor environment.

With the *VXIplug&play* concept, you designate a standard system “framework” or platform based on the system software you intend to use (i.e., Microsoft® Windows® 3.1/95/98/Me/NT®/2000, or

HP-UX*). By using the framework designation when you choose the rest of your system components, your *VXIplug&play* compliant components will be easy to use and easy to integrate into your test system. No longer should the preference for a particular software or hardware component need to lock you out of a system or platform. Another benefit of *VXIplug&play* is its portability between the Windows and HP-UX environments. This means that your application written on HP-UX can run under Windows with a simple recompile of the code. *VXIplug&play* gives you even more flexibility in meeting your test system needs in the multi-vendor environment.

* HP-UX is Hewlett-Packard’s implementation of UNIX.

Microsoft®, Windows®, Windows NT®, are registered trademarks of Microsoft Corporation.

The VXIbus Standard: More Details



In this chapter, we'll give you more detailed information about VXIbus systems. This should answer some common questions you may have about VXIbus, and help you "speak VXI" if you wish to pursue further information. The appendix of this booklet has a list of additional reading materials.

Instrumentation Environment

The VXIbus is an open standard that many manufacturers are now using to develop a wide variety of products. This means the specification must provide a well-defined environment to guarantee proper system operation. To define an environment for a variety of high-performance instruments, the specification addresses several important issues in physical and electrical compatibility.

Module Sizes

One requirement for physical compatibility is the size of plug-in modules. The VMEbus standard defined two small module sizes. They're known as A-Size and B-Size modules in VXIbus. These modules are fairly compact; it's difficult to fit multi-functional analog instruments onto them. So the VXIbus Consortium extended the VMEbus specification for module sizes- it defined two larger modules, C- and D-Size. These four module sizes allow you to make a number of price and performance tradeoffs so you can optimize your test system.

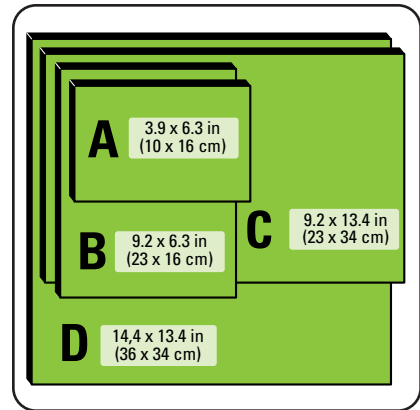

Figure 8. Different sized modules for many applications

The most common card sizes are B- and C-Size. For any system, PC-board space costs money. The B-Size format gives you an excellent tradeoff in cost and complexity, and is very useful for simpler, lower-cost instruments. Instruments that make a good fit for B-Size modules include relay multiplexers, some voltmeters and counters, and small numbers of digital-to-analog converters.

C-Size is a good size for more complex instruments requiring extra space for sophisticated circuitry or computation hardware. Since A- and B-Sizes came from the VMEbus, they retain the module-to-module spacing of 0.8 inches (2 cm) specified by VMEbus. Because C-Size is defined by VXIbus, it uses a larger spacing of 1.2 inches (3 cm). This gives C-Size modules better shielding from electrical interference, and therefore better measurement sensitivity and accuracy. Some examples of instruments that fit the C-Size format are high-performance multimeters, function generators, high-speed digitizers, and high point-count switches.

A-Size cards are too small for precision instruments, given current technologies. Still, they are a good size for communication interfaces to the non-VXIbus world. The D-Size format is useful in specialized applications, but it does result in significantly higher cost and increased rack space. As a result, almost all manufacturers are using multiple C-Size slots for complex instruments instead of putting them onto D-Size modules.

Connectors and Buses

Closely related to module sizes are the backplane connectors, shown in Figure 9. All modules must have at least one 96-pin connector, known as P1. All the pins on P1 are completely defined by the VMEbus specification. These definitions are maintained in VXIbus. P1 contains all the necessary lines for 16-bit data transfer, handshaking, bus arbitration, and interrupt support.

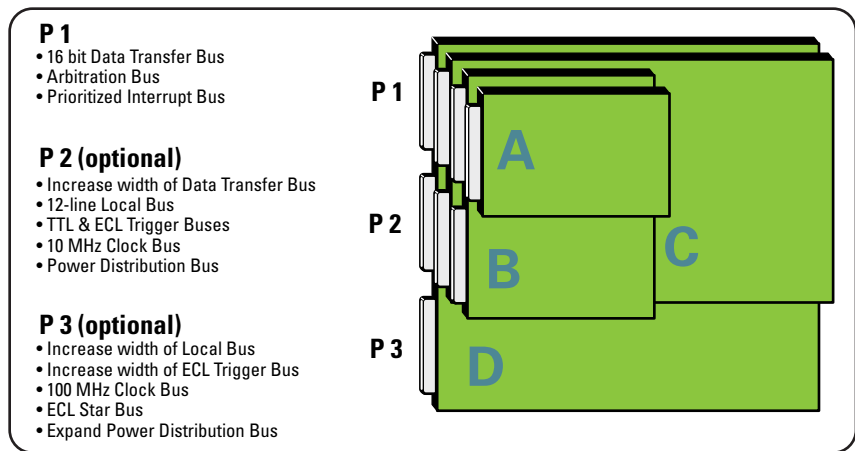
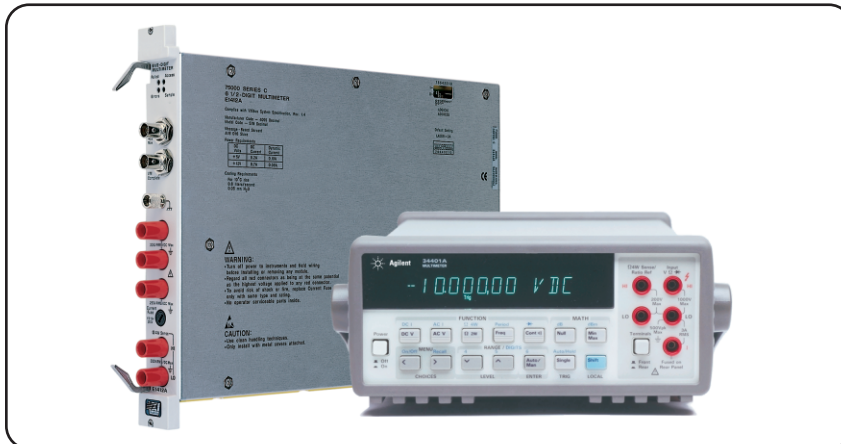

Figure 9. VXIbus modules and connectors

It's possible to add the optional P2 connector on B-Size and larger modules. This will expand the data transfer bus and provide a local bus for high-speed module-to-module communication. On D-size cards, you can add another optional connector, P3, which adds resources for specialized instrumentation. When combined with multiple module sizes, this range of connectors allows you to optimize your test system with various price and performance tradeoffs.



Agilent 34401A DMM and its VXIbus C-Size equivalent, the Agilent E1412A

Power, Cooling, and Interference

The second major issue of compatibility addressed by the VXIbus specification is the mainframe environment. VXIbus product vendors need to know exactly what type of environment their module will be used in, so they can design, test, and specify it properly. This means you can have great confidence that VXIbus systems- including those comprised of different vendors' modules- will function properly.

All VXIbus mainframes must specify how much steady-state and dynamic current they provide at different voltage levels. Also, mainframes must specify how much cooling, on a per-slot basis, they provide. VXIbus plug-in modules must provide corresponding information about their own requirements.

Plug-in modules must also specify both high-frequency emission and susceptibility. The VXIbus specification sets strict limits for the amount of interference a device may emit. Conversely, the device's operation must not be affected by neighboring modules operating within interference limits. These limits and tests apply to both radiated and conducted signals.

VXIbus Devices and Communication

What Are Devices?

In this booklet, you'll notice the term "device" used often. The simplest way to think of a device is as a plug-in module, or card. In VXIbus systems, every device must have a unique address from 0 to 255, called its Logical Address. This distinguishes it from other devices in the system.

Every VXIbus device is granted 64 absolute addresses on the backplane. You can think of this as 64 bytes of RAM on the device that can be addressed and accessed by other devices in the system. This little block of memory serves two main purposes- it contains information about the device and its communication capabilities, and it's also the location where all required communication with the device takes place. The device's Logical Address determines the address of this "information and communication memory" within a VXIbus system. This 64-byte chunk of dedicated memory contains the device's "Configuration Registers" and "Communication Registers."

The VXIbus specification defines four types of devices- Register-Based, Message-Based, Memory, and Extended. Memory devices are just specialized Register-Based Devices that are optimized to hold and move large amounts of data. Extended Devices are currently reserved, and provide a growth path for new types of devices in the future.

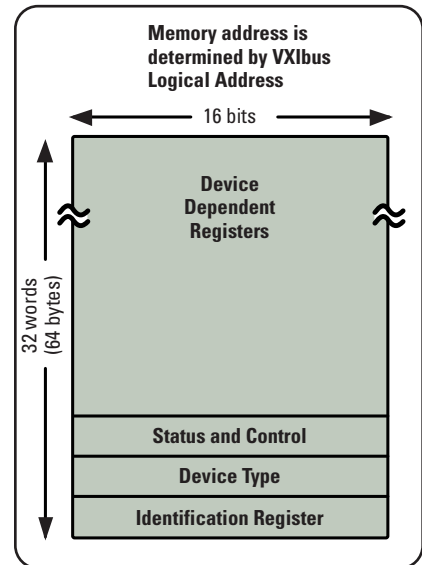
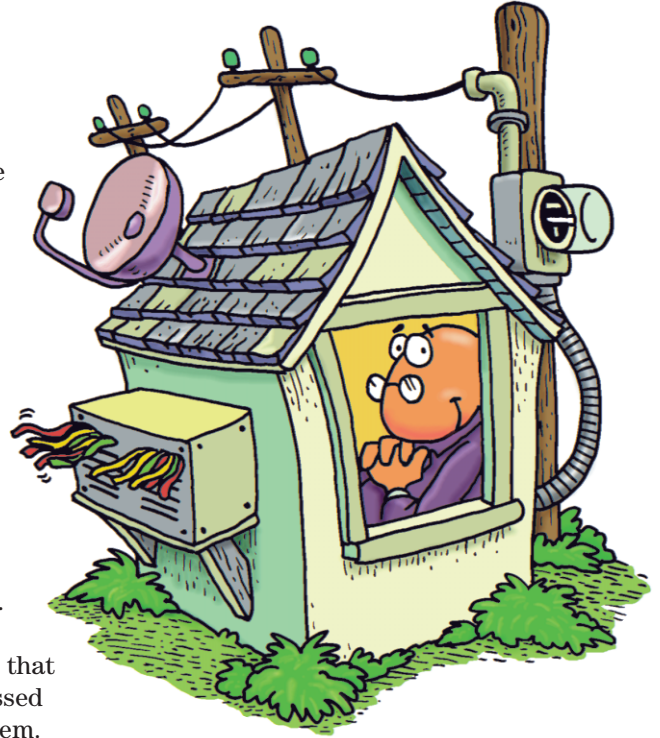

Figure 10. VXIbus device registers. Memory address is determined by VXIbus logical address.

Register-Based Devices

In the first section of this booklet, we said that VXIbus Register-Based Devices communicate much like VMEbus Devices. This means that they're programmed at a low level using binary information. The obvious advantage of this is speed-Register-Based Devices communicate literally at the level of direct hardware manipulation. This high-speed communication can lead to much greater test system throughput.

All types of devices in a VXIbus system must have some sort of communication interface to the VXIbus backplane.

One advantage of Register-Based Devices is that this interface is very simple, and thus small and low in cost.

The Register-Based Device is ideal for simple cards such as switches, multiplexers, basic DACs, etc. There's little reason to put a large, expensive communication interface on these devices. The register-based interface is also a

good choice for devices that may need to move large amounts of information across the VXIbus backplane at very high speeds-for example, high-speed digitizers and high-speed digital I/O cards.

You might think Register-Based Devices are limited to being very simple devices. However, this is not the case. For example, a register-based digital multimeter may communicate with other devices using low-level binary commands, but it could also have an internal microprocessor for sophisticated measurement control and self-diagnostics.

A lot of people like Register-Based modules because of their low cost, but don't want to have to program them with low-level binary commands. VXIbus answers this concern with a concept called Commanders and Servants (not a video game). A device that contains the intelligence to operate a Register-Based Device can be configured as a Commander to that Register-Based Device. You send high-level

ASCII commands to the Commander, it interprets them, and then sends the necessary binary information to the Register-Based Servant. In this mode, you program Register-Based Devices exactly as if they are Message-Based Devices. Figure 12 shows the options available for programming Register-Based Devices.

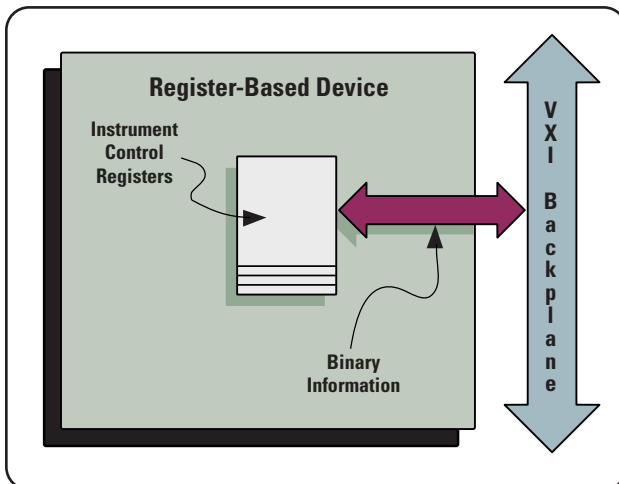

Figure 11. Register-Based communication

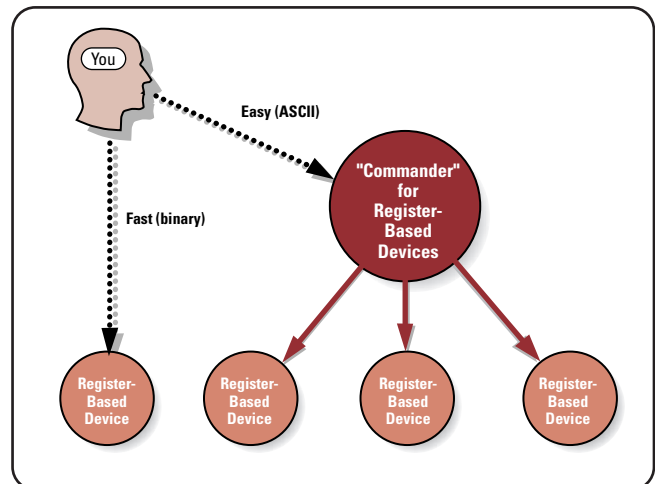

Figure 12. Paths for register-based communication

Message-Based Devices

Message-Based Devices, in contrast to Register-Based Devices, communicate at a very high level using ASCII characters. A good analogy for these devices is standalone GPIB instruments. Message-Based Devices are very easy to integrate into VXIbus systems. This is especially important in systems comprised of modules supplied by different vendors.

Message-Based Devices communicate with each other with a well-defined set of rules known as “Word Serial Protocol.” This asynchronous protocol defines the handshaking necessary to move commands and data between devices.

One advantage of Word Serial Protocol is that it hides compatibility concerns from you, the user. That’s why Message-Based Devices are easy to integrate into a system. To program them, you simply send and retrieve high-level ASCII characters. The characters you send must be in the device’s specific language, but you don’t have to worry about module-specific registers, binary reading and writing, etc.

Two tradeoffs are required to have this ease of use. First, the communication interface required to implement the Word Serial Protocol is complex. This means it takes up more “real estate” on the circuit board than the communication interface of a Register-Based Device. Hence, a Message-Based Device will always cost more than an equivalent Register-Based Device. Also, because of the space committed to communication rather than measurement circuitry, Message-Based instruments will generally be on C-Size or larger modules.

Second, the communication speed between devices is lower. It’s roughly equal to that of GPIB. However, most sophisticated devices will have on-board data processing, so they may only need to pass a final result from the device to the controller. An example of this is an oscilloscope that digitizes a waveform and then automatically measures rise time. Only the rise time is passed from the instrument, not all the digitized readings.

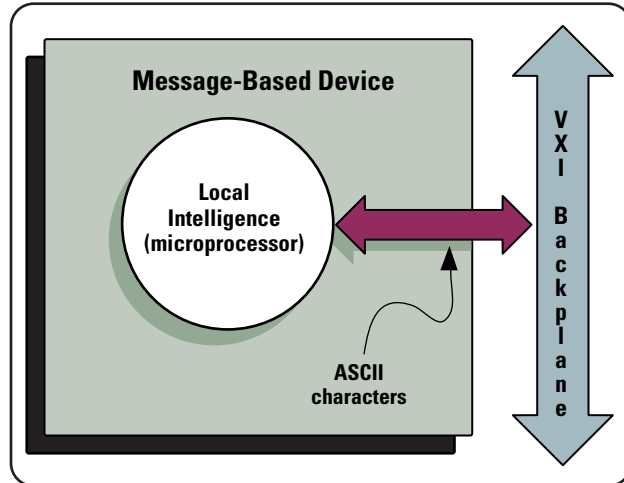

Figure 13. Message-Based communication

More on Communication

The ability to communicate between devices, the VXIbus backplane, and computers is an integral part of any VXIbus test system. We've already defined the two primary types of devices - Register and Message - and how they are set up for communication. How can we improve data transfer, or make measurements for tests requiring transfers of large amounts of data? How can we continue to grow test systems and keep cost low? With new developments in external interfaces and both external and embedded computers, the rules are changing and more options are being created for answering these questions.

GPIB & LAN

As noted earlier, one limitation of GPIB is its maximum data transfer rate: about 1 Mbyte per second. If GPIB speeds meet your application needs, you can add the flexibility and long-distance capabilities of LAN to your test system architecture. For instance, a LAN/GP-IB Gateway, with measurement server software, allows test systems, whose components have GPIB interfaces, to be controlled by a computer via a thin or twisted pair LAN. It is particularly useful when the device under test is in a protective or environmental chamber some distance away from the computer; engineers can follow the test run's progress from a workstation at their desks. You can also control multiple

GPIB test stations with one computer by connecting each test station to the LAN through a GPIB/LAN Gateway. Another advantage is the ability to create measurement servers on the network. This allows you to use a measurement server to collect test data and analyze it from multiple locations.

External Interfaces

There are three basic choices for interfacing between the VXIbus backplane and your computer. The most common is the popular GPIB (IEEE-488) interface. A GPIB Command Module resides in slot 0 of the VXIbus system, providing the required Resource Manager and Slot 0 functions, and acting as a GPIB-to-VXIbus interface. This interfacing choice easily allows you to combine your VXIbus system and other GPIB instruments on one computer interface.

As the computer industry evolves and creates new industry-standard interfaces, VXIbus vendors are taking advantage of these interfaces. FireWire (IEEE-1394) is a low cost interface that offers the ability to move data at much faster rates than GPIB. Compared to GPIB's theoretical limit of 1 Mbyte/sec, FireWire has an upper limit of 50 Mbytes/sec. For applications requiring the transfer of large blocks of data, such as uploading sequences of digitized waveforms, FireWire is a very attractive solution. In a manner similar to

GPIB, a FireWire Command Module resides in slot 0 of the VXIbus system, providing the required Resource Manager and Slot 0 functions, and acting as a FireWire-to-VXIbus interface. Since FireWire is a recognized standard within the computer industry, it is built into increasing numbers of PCs as a standard feature. FireWire interfaces are also available to plug into PCs as PCI cards. You can also easily use both FireWire and GPIB interface cards in your PC to communicate with all your test system resources, no matter what kind of interface they use.

Another proprietary interface, called MXIbus, has been developed for VXIbus systems. With this scheme, a MXIbus module plugs into slot 0 of the VXIbus mainframe and connects to the MXIbus interface card in the external computer. MXIbus provides the speed and throughput of direct memory-mapped access to the VXI backplane. Due to its proprietary nature and its design that directly extends the VXIbus backplane, MXIbus is higher in cost than the industry-standard alternatives of GPIB or FireWire.

With these advances in external interfaces, VXIbus vendors continue to push the limits for faster and more configurable communication tools.

Embedded vs. External Computers

In addition to a rich choice of interfaces between an external computer and the VXIbus backplane, you can also put your computer directly on the VXIbus backplane and inside the VXIbus mainframe. Whether you choose an embedded or external computer will depend on your test system needs. To select the best computer, consider several factors: operating system, throughput, ease of use, physical size, configuration flexibility, and cost.

For example, if your application requires the greatest possible throughput, a VXI embedded PA-RISC computer using HP-UX - the 9000 Series 700 - may best fit your needs. Using this computer in conjunction with VXI devices that use high-speed register-level communication gives you maximum throughput.

When space is at a premium in your test system set-up, embedded computers are extremely valuable. Embedded computers integrate high functionality into small modules for use in C-Size VXI mainframes. Embedding the computer in the VXI chassis allows direct computer access of other VXI devices, system memory, and triggers as though they were part of the computer hardware. You get the highest speed performance and computer access to VXI devices while still conserving space. An embedded computer also allows you to enclose and secure your computer in the same enclosure as your VXIbus system.

With external computers, you have a huge choice of PCs and Unix workstations. You can choose the combination of cost and performance that best meets the needs of your application. An external computer allows

you to reap the benefits of the fast-paced, changing technology of the computer industry. You can take advantage of continuous improvements in price and performance, and can upgrade your computing power and performance as your test system requires. An external computer requires the use of an interface to connect to the VXIbus backplane. If you need easy access to your computer as you develop a test application and cost is a primary concern, an external computer - PC-based or UNIX-based - may better fit your needs. With an external computer, you can cycle the VXIbus mainframe power without having to reboot an embedded computer's operating system. If you have custom VXI modules as part of your test system, this can be very important during application development.

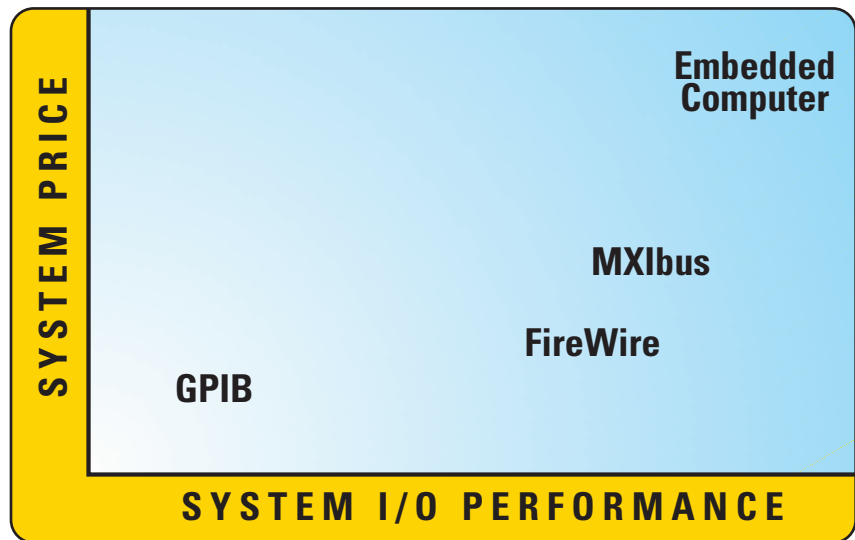

SCPI: More Details

The cost of software for a test system is often greater than the cost of the hardware. In the late 1980's, Agilent Technologies invented and offered to make TMSL (Test and Measurement Systems Language) an open standard. In April 1990, this standard was accepted, and renamed SCPI (Standard Commands for Programmable Instrumentation). SCPI complements the VXIbus and VXI*plug&play* specifications, helping you protect your investment by using an industry-accepted standard.

SCPI differs from earlier instrument languages in that the commands describe the signal you're trying to measure, not the instrument you're using to measure it. This means programs written with SCPI are more readable and intuitive. You spend less time learning about your instruments, and more time solving your application problems. This feature, known as "horizontal compatibility," means that the same SCPI commands apply to many different types of instruments.

For example, the "TRIGGER:IMMEDIATE" command can be used with a multimeter, oscilloscope, or any other instrument with trigger capability.

SCPI is also designed to be extensible, allowing it to grow as instrument capabilities grow. Suppose that in the future you buy a multimeter with more features than your current unit. Its basic functions will be programmed exactly like the old unit. This "vertical compatibility" results in lower support costs, obsolescence protection, and an upgrade path. Headers, mnemonics, and parameter formats are standardized as well.

All Agilent Technologies VXIbus products are programmed with SCPI commands. You learn just one programming language that, in turn, increases your programming efficiency and reduces the time you spend on development. It also ensures that your investment in instrument control software is protected.

```
OUTPUT@Dmm; "*RST"           ! Reset all the
OUTPUT@Scope; "*RST"        ! test system
OUTPUT@Counter; "*RST"      ! instruments.

OUTPUT@Scope; "MEASURE:VOLTAGE:RISETIME?" ! Use oscilloscope to
ENTER@Scope; Risetime       ! measure wave form risetime.

OUTPUT@Dmm; "MEASURE:VOLTAGE:DC?" ! Use DMM to accurately
ENTER@Dmm; Dc_level         ! measure final signal level

OUTPUT@Counter; "MEASURE:FREQUENCY?" ! Use counter to measure
ENTER@Counter; Frequency   ! freq of another signal
```

Figure 14. SCPI's horizontal compatibility

VXIplug&play: More Details

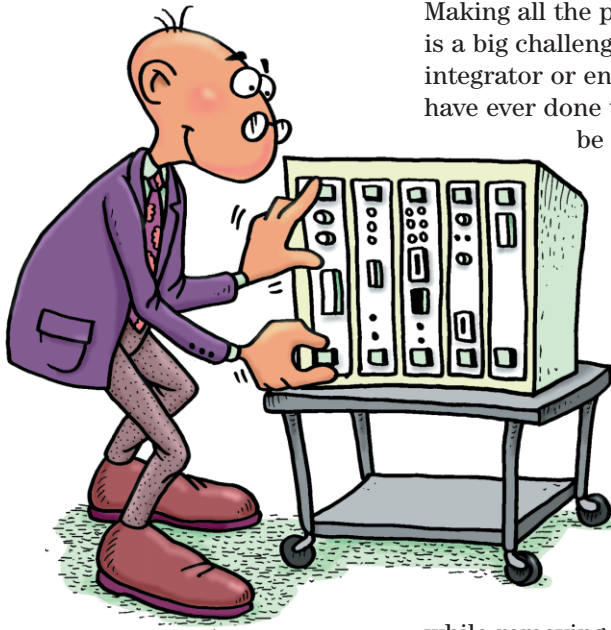

Making all the pieces fit together is a big challenge for any system integrator or engineer. If you have ever done this, you will

be amazed at the benefits that *VXIplug&play* brings to the Test and Measurement industry.

VXIplug&play compliant systems provide the mechanisms for you to build systems that meet your specific application needs,

while removing concerns about software interoperability. The *VXIplug&play* Systems Alliance has achieved this by defining and implementing requirements for the entire test system- including software, I/O communication, drivers, installation packages, computers and interfaces.

How does *VXIplug&play* Work?

To understand how *VXIplug&play*-compliant components work together, you must understand each of the different pieces. Of course, it begins with you and your application. Then, you choose your system framework. Figure 15 is a simple display of these pieces.

Frameworks

The *VXIplug&play* Systems Alliance has defined several “frameworks” based on established industry-standard operating systems. Specifically, a framework relates to a particular operating system (for example, Windows 3.1/95/98/Me/NT/2000, HP-UX, GWIN, and others), and specifies the requirements for instruments, controllers, interfaces, mainframes, and software packages that comply with that system.

To make the example in Figure 15 work, the specification assigns a framework designation to each different piece of the system.

What does all this mean to you, the test engineer or integrator? Once you choose the framework based on the system software that meets the needs of your unique test application, then the framework designation is all you need to know when choosing the rest of your system components. An Alliance specification defines each *VXIplug&play* framework, with detailed requirements for all system pieces – from top to bottom.

For example, say you've chosen Windows 95 as your system framework. You will need to select a PC, interface, VXI mainframe, and VXI instruments that are WIN 95 Framework-compatible. Manufacturers of these system components have already identified which are *VXIplug&play*. One of the instruments you may need is an Agilent E1412A Digital Multimeter. Because of *VXIplug&play*, you will automatically receive an installation disk or CD with the appropriate library files (i.e., .dll), MS WIN help files, knowledge base file, and an executable soft front panel file. (For more detail on these features, keep reading.) The *VXIplug&play* Specification requires the manufacturer to supply all of this support material with this (and every) instrument driver.

Instrument Drivers

One of the most exciting developments from the Alliance is standard instrument drivers. The instrument drivers take care of the low-level details of I/O communication. As a test system developer, you no longer need to deal with low-level I/O protocols! As defined by the Alliance, *VXIplug&play* instrument drivers include the following features:

C function library files

C function library files contain a dynamic link library (.dll or .sl), ANSI C source code (.c, .h), and function panel file (.fp). It uses the VISA I/O Library for all I/O functions. With these tools, you have high-level, easy to use C functions for your application.

Interactive soft front panel executable program

A soft front panel is a graphical user interface for an instrument. However, soft front panels do not generate code and are not for use in a program. You use the soft front panel when the instrument is first integrated into the system. You can verify your instrument communications, or use it as a learning tool to teach instrument control and capability concepts. Many test system users like this feature because it is quick and easy to determine if the instrument is ready for use.

This tool is specifically useful for system integration and for incoming inspection tasks. It is also an integral part in making your system easier to use.

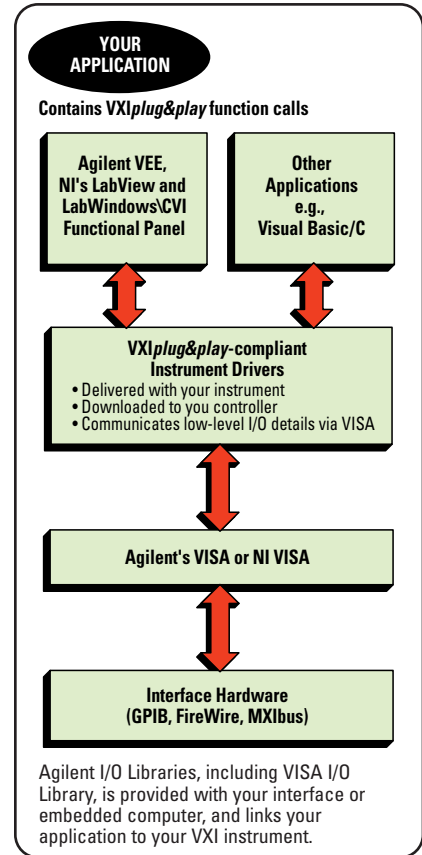

Figure 15. A *VXIplug&play*-compliant system

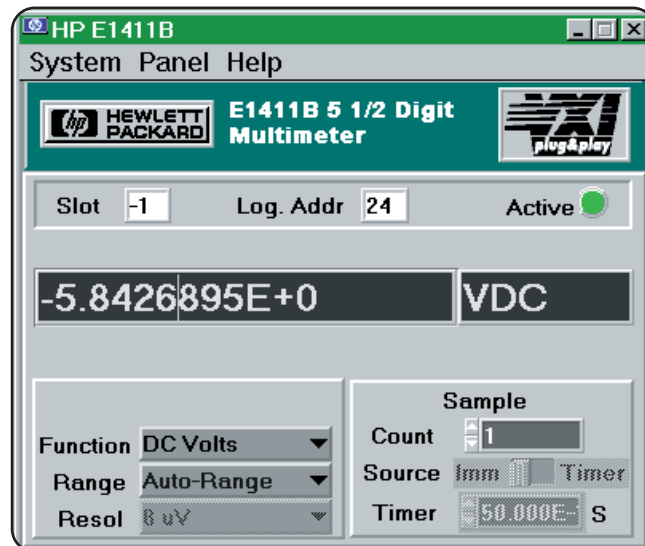

Figure 16. A *VXIplug&play* soft front panel

Knowledge base file

A knowledge base file describes all specifications for an instrument as an ASCII file. These specifications include mechanical, electrical, and environmental information. This is useful when used as a system integration tool for multi-vendor systems.

Help file

A help file provides help information for the C function library, programming examples, instrument overview, and the soft front panel. You can copy or paste the programming examples directly into your application program. This can greatly reduce your development time.

VXIplug&play requires delivery of the instrument driver with your instrument. All you need to do is load it onto your computer.

VISA I/O Library

Without a common I/O library, interoperability of system components is not possible. Therefore, a standard I/O library became a primary goal of the *VXIplug&play* Alliance. I/O software takes care of the communication over a physical connection, and is the foundation on which other standards are built. To move away from existing proprietary systems, languages, and I/O, the library needed to be independent of instrument, interface, operating system, language, or networking mechanisms.

The *VXIplug&play* Alliance calls the new standard I/O library "VISA"- Virtual Instrument Software Architecture. VISA provides a single foundation for multi-vendor instrumentation software. The development of VISA provides access to new capabilities as technology changes, as well as maintaining a migration path for existing systems. VISA offers all of these as a single, easy-to-use set of I/O control functions very similar to existing I/O libraries, such as Agilent's SICL.

VISA provides a set of core functions- Location and Life Cycle Control (open, close), Events (enable, disable), and Message-Based Control (write, read, print), just to name a few. Each of these functions applies to all instruments. This means you can use VISA's open (or viOpen) function call for any device in your test system.

VISA's development and standardization offer you even more benefits. With fewer functions to learn, you reduce the time spent learning a new tool. Since it is similar to existing I/O libraries, you probably already have the knowledge to begin development of your application. Another great benefit of VISA is its portability between frameworks. Your applications written on HP-UX can run under Windows with just a simple recompile of the code. You are no longer platform-dependent! VISA gives you system-level confidence and removes your dependency on a single vendor's I/O strategy.

Putting It All Together

A VXIbus system can be thought of as a collection of tasks to be performed. Most of these tasks will be specific to your application, while some of them must be done in every VXIbus system.

Yesterday, a discussion about the “typical” VXIbus system would discuss Resource Manager, Slot 0 Functions, GPIB, and Command Modules. Perhaps you could configure one or more CPUs into the system to store and process information. Even though Resource Manager and Slot 0 Functions are unique to VXIbus systems, today we look at test systems differently. Never before has the system integrator been able to benefit from the large selection of open test system components! Now available from Agilent Technologies and a growing list of instrument manufacturers is standard, off-

the-shelf test system hardware and software: PCs or UNIX computers (standalone or VXI format); IEEE-488, IEEE-1394, and MXIbus interfaces; and VXIbus instrumentation. VXI is a completely open environment for both hardware and instrument control software. You specify the *VXIplug&play* framework based on the operating system, and then select the rest of your system components based on that framework. If you already have a test system set-up, you can continue with your GPIB solution and begin moving to higher-performance VXI solutions as your needs grow.

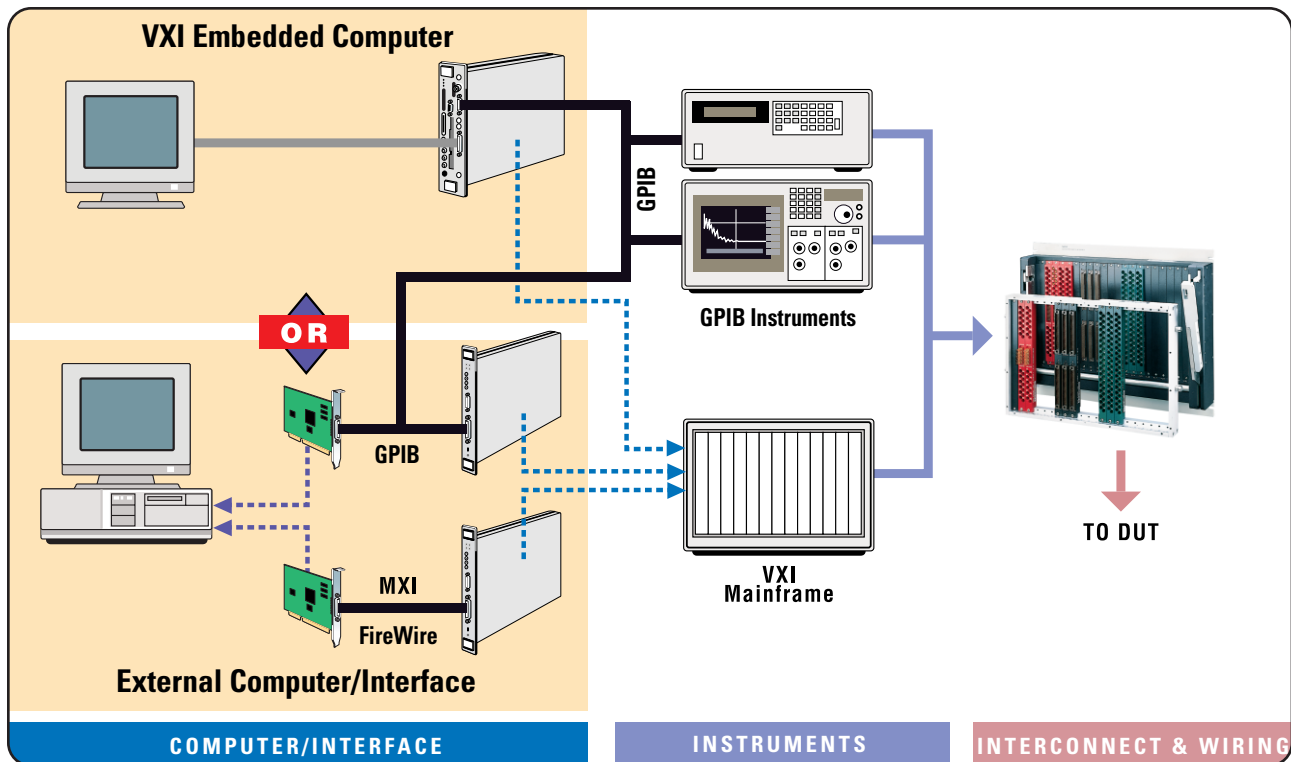

What has Agilent Technologies Done to Improve Upon VXI Technology?

By now, you can see that VXIbus and VXI*plug&play* standards provide a well-defined hardware and software environment, in which modules from many different manufacturers can work together. How is Agilent Technologies involved in this process?

In the past, Agilent participated in the standardization process by providing technology and developments of our own to everyone in the industry- GPIB (IEEE-488) and SCPI. Thus, Agilent was one of the first instrument manufacturers to realize the need for industry standards. Today, Agilent's commitment to these and to new standards continues to grow with the needs of the Test and Measurement industry.

Agilent VEE, Agilent's Visual Engineering Environment, is VXI*plug&play*-compliant for Agilent instruments, as well as for non-Agilent products. How? Agilent VEE can access and load any instrument driver written to the VXI*plug&play* standard. The instrument driver then provides a procedural interface to the instrument for programmatic control. Agilent VEE uses a graphical user interface to make it easy for you to develop the code necessary for controlling your instruments.

Agilent also provides soft front panels and robust help files with all instrument drivers to help you understand and operate your instruments quickly. Since most complex test systems are not completely populated with VXI, Agilent is a leader in providing a common driver strategy for both VXI and non-VXI (GPIB) instruments.

Even though VXIbus and VXI*plug&play* define both the hardware and software environments, these standards still do not address everything you'll need for a total system solution. Agilent offers an instrument family that has a consistent "look and feel," provides many cost and performance alternatives, is easy to integrate, and allows you to get your test system operating quickly.

Summary

During its first decade, VXIbus has spawned an unexpected level of industry cooperation in achieving a truly open modular instrumentation architecture. It's easy to understand how industry standards deliver benefits. One only has to observe the success of the PC, as thousands of computer users switched to this open platform so broadly supported by the computer industry. The VXI platform now brings the same benefits to instrument users:

- Today, VXI is a stable, highly standardized platform with hundreds of products available, making your investment secure. As you combine hardware and software from a variety of vendors, you're assured that your system will work.
- VXI provides scalable, configurable solutions that adapt to your unique measurement situation allowing you to trade-off cost and performance. And VXI is easily integrated into existing or new rack and stack systems for complete solutions that can reduce your cost of test.

- VXI has spawned other open standards, that help you save development time, and protect your system investments -for instance, SCPI and *VXIplug&play*.
- VXI has influenced the development of test software programming languages, such as Agilent VEE, that complement and support the VXI environment and allow an unprecedented level of test software development productivity, saving time and money.

With VXI technology rapidly emerging as the industry standard in all facets of instrumentation, you can expect manufacturers to continue to provide even greater productivity gains, as well as to reduce test system costs. Agilent Technologies will continue to be the leading manufacturer in VXI technology and products, and will continue to drive industry standards that truly benefit instrumentation users.

Agilent Technologies' Test and Measurement Support, Services, and Assistance

Agilent Technologies aims to maximize the value you receive, while minimizing your risk and problems. We strive to ensure that you get the test and measurement capabilities you paid for and obtain the support you need. Our extensive support resources and services can help you choose the right Agilent products for your applications and apply them successfully. Every instrument and system we sell has a global warranty. Support is available for at least five years beyond the production life of the product. Two concepts underlie Agilent's overall support policy: "Our Promise" and "Your Advantage."

Our Promise

Our Promise means your Agilent test and measurement equipment will meet its advertised performance and functionality. When you are choosing new equipment, we will help you with product information, including realistic performance specifications and practical recommendations from experienced test engineers. When you use Agilent equipment, we can verify that it works properly, help with product operation, and provide basic measurement assistance for the use of specified capabilities, at no extra cost upon request. Many self-help tools are available.

Your Advantage

Your Advantage means that Agilent offers a wide range of additional expert test and measurement services, which you can purchase according to your unique technical and business needs. Solve problems efficiently and gain a competitive edge by contracting with us for calibration, extra-cost upgrades, out-of-warranty repairs, and on-site education and training, as well as design, system integration, project management, and other professional engineering services. Experienced Agilent engineers and technicians worldwide can help you maximize your productivity, optimize the return on investment of your Agilent instruments and systems, and obtain dependable measurement accuracy for the life of those products.

By internet, phone, or fax, get assistance with all your test & measurement needs

Online assistance:

www.agilent.com/find/assist

Phone or Fax

United States:

(tel) 1 800 452 4844

Canada:

(tel) 1 877 894 4414

(fax) (905) 282 6495

Europe:

(tel) (31 20) 547 2323

(fax) (31 20) 547 2390

Japan:

(tel) (81) 426 56 7832

(fax) (81) 426 56 7840

Latin America:

(tel) (305) 269 7500

(fax) (305) 269 7599

Australia:

(tel) 1 800 629 485

(fax) (61 3) 9210 5947

New Zealand:

(tel) 0 800 738 378

(fax) 64 4 495 8950

Asia Pacific:

(tel) (852) 3197 7777

(fax) (852) 2506 9284

Product specifications and descriptions in this

document subject to change without notice.

Copyright © 2001 Agilent Technologies

Printed in the USA April 16, 2001

5988-2372EN



Agilent Technologies