

Agilent Performance Spectrum Analyzer Series Swept and FFT Analysis

Application Note

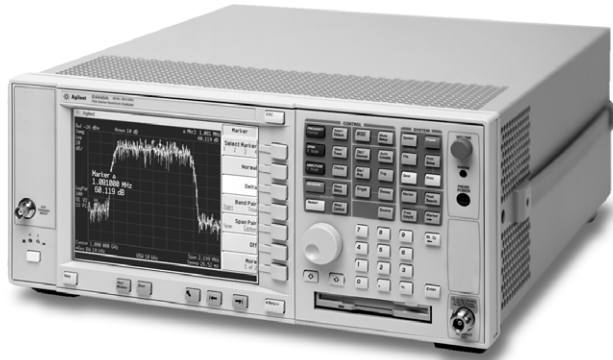

Spectrum analysis measurements often involve trade-offs between accuracy, speed and dynamic range. In most cases, emphasis on one of these parameters adversely impacts the other two. For example, the wide resolution bandwidths (RBW) used to achieve fast measurement speeds result in higher noise levels and potentially reduce dynamic range. Increasing the sweep rate improves measurement speeds for a given RBW but reduces accuracy due to inadequate settling time for the intermediate frequency (IF) filters. Alternatively, dynamic range may be emphasized at the expense of measurement speed because of the need to use narrow (slow sweeping) RBW filters and, in some cases, averaging.

The Agilent Technologies performance spectrum analyzer (PSA) series (model E4440A) provide major improvements in each of these three measurement factors of speed, dynamic range and accuracy. They also offer major increases in ease-of-use and measurement reliability. These improvements are primarily the result of an innovative hardware and firmware architecture, based on an analog foundation of exceptional performance. In addition, the autocoupling implemented in the PSA's firmware provides an easier and more reliable path to high quality measurements.

The PSA series cannot eliminate the trade-offs described above, as some of them are due to the inherent limitations of measurement physics. However the innovations in digital filtering (a digital implementation of a traditional swept IF section) and fast Fourier transform (FFT) analysis of the PSA series provide the user with a dramatic improvement in the trade-offs required.

This product note will describe the use of FFT and swept analysis in the PSA series, along with the implications for measurement speed, accuracy, and dynamic range. It will summarize the autocoupling functions and demonstrate how to tune them to optimize one or more of the major measurement parameters described here.



Table of Contents

Comparing the Amplitude Accuracy of Swept and FFT Techniques	2
Comparing the Dynamic Range of Swept and FFT Techniques	3
ADC Bandwidth in Swept and FFT Techniques	3
Effect of Autoranging on Swept and FFT Techniques	4
Effect of Signal Statistics on FFT and Swept Measurements	4
Speed of Swept Techniques Using a Digital Filter	5
Faster Sweep Rates and Compensation of Sweep Rate Effects	6
Speed of FFT Techniques versus Swept	7
Continuum of Performance Between FFT and Swept Analysis	8
Dynamic Range of the Multiple-FFT Measurement Type	8
Measurement Speed of the Multiple-FFT Measurement Type	8
Automatic Selection of Sweep Type	9
Manual Selection of Sweep Type	9
Conclusion	11
References	11

Comparing the Amplitude Accuracy of

The PSA series analyzers use both swept and FFT analysis techniques for spectrum measurements. Amplitude flatness errors are present in both techniques, although the eventual (after correction) accuracy of the swept technique is higher. Figure 1 illustrates this point.

In a swept spectrum analyzer the amplitude accuracy of the RBW filters (termed “RBW switching uncertainty”) can be quite high because they are all centered at the same frequency. In the case of FFTs, however, the flatness of the IF preceding the analog to digital (A/D) process is a factor in determining accuracy. A broad flat response is needed or else errors result due to the non-flatness of the IF. This non-flatness is measured and results are compensated accordingly, but the process is imperfect and flatness errors as large as ± 0.25 dB can remain.

Other amplitude accuracy terms affect both FFT and swept analysis techniques to a similar extent. The exceptional amplitude accuracy of the PSA series results from a variety of design factors and built-in calibration capabilities, along with the use of an all-digital IF section. Using digital signal processing (DSP) instead of a series of analog gain and filtering stages eliminates or vastly reduces many sources of error including IF gain uncertainty, RBW switching error, RBW filter bandwidth uncertainty, etc.

For more information on the exceptional amplitude accuracy of the PSA series, and suggestions for optimizing accuracy in typical measurements, see the PSA series product note entitled “Amplitude Accuracy” literature number 5980-3080EN.

Comparing the Dynamic Range of Swept and FFT Techniques

Digital technologies such as analog to digital converters (ADCs) and digital signal processing (DSP) have become more common in spectrum analyzers, gradually moving from data display functions toward the analyzers' inputs. In most existing analyzers this digital technology is concentrated in the stages following the final IF (RBW filtering) and logarithmic amplifier.

In the PSA series the use of these digital technologies begins in the final IF, where the IF signal is digitized, and RBW filtering is performed by FFT techniques or by the digital implementation of swept IF filters. Moving the ADC process to this stage in signal processing can affect the dynamic range of the analysis in ways that must be understood to realize the optimum dynamic range

First, it is important to understand some of the general characteristics of the ADC process. An ADC measures individual samples of the IF input signal with very wide bandwidths, down to very low noise-levels. However the ADC converter is an inherently noisy device and its quantization noise always exceeds the thermal noise of the input. Therefore it is difficult to maintain the maximum signal-to-noise ratio (SNR) without the use of additional processing or filtering. In virtually all ADCs, the noise bandwidth of the sampling process is much wider than the sampling rate. In fact it is typical for the noise bandwidth to be 40 or more times greater than the sampling rate.

In the PSA series, where either swept analysis (using digital filters) or FFT analysis can be used, some dynamic range advantages are inherent in swept analysis. These advantages are due to the effective ADC range enhancement from autoranging and to the bandwidth associated with the ADC process. The relative bandwidths of FFT and swept analysis are shown in Figure 2.

Figure 1
Calibration of swept filters is easier because they are all centered at the same frequency.

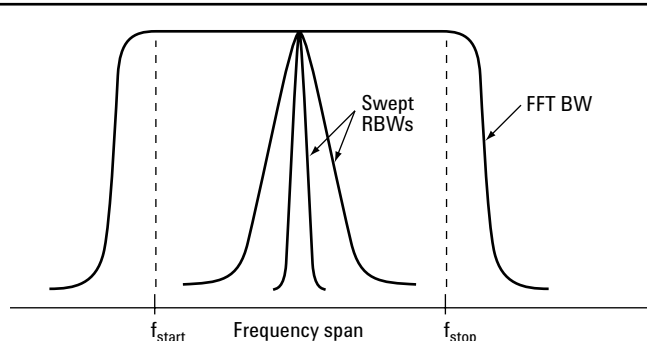
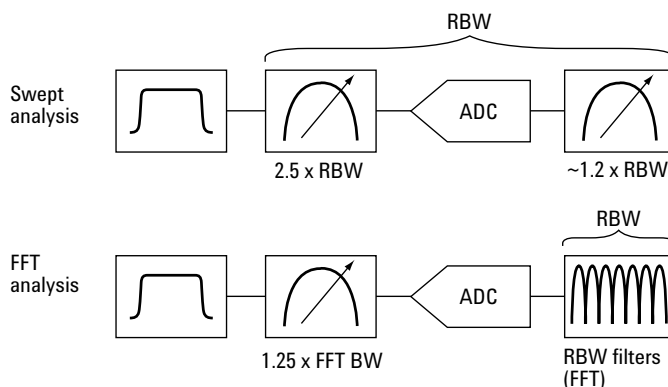

Figure 2
An important factor in the dynamic range of swept vs. FFT techniques is the bandwidth associated with the ADC process.



ADC bandwidth in swept and FFT techniques

The effective signal/noise ratio (SNR) of the ADC process can be improved substantially by limiting its bandwidth. In the case of swept analysis in the PSA series, an analog prefilter limits the input bandwidth to the ADC to approximately 2.5 times the RBW. The analog prefilter is also used in FFT analysis, but its dynamic range benefits are limited due to its

wider bandwidth. Because the entire frequency span is processed at once in the FFT, the analog prefilter bandwidth is set to approximately 1.25 times the FFT bandwidth. For typical values of RBW and FFT bandwidth, the prefilter bandwidth is approximately 60 times wider when using FFTs than for swept measurements.

Effect of autoranging on swept and FFT techniques

Autoranging is a powerful technique for extending the range and resolution of an ADC system (and therefore its dynamic range). In swept analysis, the magnitude or envelope of the prefilter bandwidth response varies slowly enough that the ADC can actually change range (autorange) to track this envelope. With range changes, the dynamic range (ratio of peak signal handling capability to noise level) increases by the amount of the allowable range change.

Autoranging may also be used in FFT analysis, however the range cannot be changed within the frequency span of a single FFT. Thus the noise floor within each FFT is typically higher, and this in turn limits the overall dynamic range. Swept analysis therefore yields better dynamic range.

As described previously, traditional FFT analysis is performed on a time record representing the entire frequency span of a measurement. Therefore the dynamic range benefits (due to filtering and autoranging) of using multiple FFTs to cover a given frequency span should be considered. This approach is indeed implemented in the PSA series, and is described later in this product note.

Effect of Signal Statistics on FFT and Swept Measurements

The dynamic range which can be achieved in measuring different types of signals depends on their statistical nature. In the PSA series, the combination of an autoranging ADC, preceded by a variable-bandwidth tracking prefilter, can produce phase noise-like behavior in the measurement results. This behavior is similar to phase noise in that the displayed noise sideband level is proportional to the signal amplitude and it decreases or falls off in amplitude with increasing offset from the signal.

For measurements of continuous wave (CW) signals, the close-in noise sidebands due to autoranging are in the range of -128 to -134 dBc/Hz. These sidebands decrease further in magnitude at offsets greater than $\pm 1.25 \times \text{RBW}$ in swept analysis, and offsets greater than $\pm 0.7 \times \text{FFT-width}$ in FFT analysis. For FFT analysis, the noise sidebands due to autoranging will become visible above LO phase noise at offsets beginning at approximately ± 200 kHz. Therefore, for frequency spans narrower than 400 kHz, the dynamic range of a measurement using FFT analysis is virtually the same as one made using swept analysis.

For non-intermodulating signals with high spectral density, two characteristics of the PSA should be considered. First, the front-end circuits experience less than 1 dB of compression for signal levels at the input mixer up to +5 dBm (typical). Second, the ADC clips at about -8 dBm, producing large intermodulation and compression effects. Therefore measurements of signals such as FM, ϕM , and pulsed-RF, which do not intermodulate, can take advantage of the increased dynamic range resulting from high

signal levels at the input mixer. However, measurements of signals such as QAM, QPSK and CDMA, which do intermodulate, must be made with lower levels at the input mixer to avoid TOI effects.

One particular example of a signal type with high spectral density is pulsed RF. When measuring pulsed signals, a narrow prefilter can reduce the drive level to the ADC by about $20 \log(\tau \times \text{BW})$, where τ is the pulse width, and BW is the bandwidth of the prefilter. Reducing the ADC drive by 13 dB in this manner will improve the dynamic range by 13 dB, so long as enough signal power is available to drive the mixer. (13 dB is the difference between the compression threshold of the front-end and the clipping threshold of the ADC). Narrowing the bandwidth of the prefilter even more can further reduce the ADC drive level, allowing ranging gains to be set higher and providing corresponding increases in dynamic range.

One final example of a signal with high spectral density is FM. While a narrow prefilter can improve dynamic range in measurements of FM signals by reducing the drive level to the ADC, as described with pulsed RF signals, the effectiveness of the prefilter will decrease. With pulsed RF signals, the dynamic range improvements are proportional to $20 \log(\text{BW})$. However, with FM signals, the dynamic range improvements are proportional to $10 \log(\text{BW})$. In addition, there is a further loss in prefilter effectiveness of 8.5 dB because the peak-to-average ratio of the signal at the ADC changes from 0 dB (for the constant amplitude signal observed in a wide bandwidth), to 8.5 dB (for noise-like modulations observed in a bandwidth that is narrow compared to the modulation width)

Speed of Sweep Techniques Using a Digital Filter

Long measurement times in swept spectrum analysis typically result from measurements that require a narrow RBW and a comparatively wide frequency span. This situation is encountered in frequency spans below approximately 100 kHz and also in measurements such as low-level spurious searches where narrow RBWs are used to reduce the displayed average noise level (DANL).

For narrow RBW swept measurements, the limiting factor in measurement speed is the ability of the RBW filter to respond to the envelope or the magnitude variations resulting from the sweep process. The limited response speed of the RBW filter is exhibited as amplitude and frequency errors, frequency domain asymmetry, and potentially poorer filter shape factor. These errors increase as sweep time is decreased (sweep rate is increased) for a given RBW filter.

In traditional swept spectrum analyzers, these sweep errors are held within known values by limiting the sweep rate of the RBW filters. The response errors of the RBW filters vary with the square of the RBW itself, and thus become dramatically lower as RBW is reduced. Approximately Gaussian filters are most commonly used in swept spectrum analyzers due to their good selectivity (for equal-level signals) and comparatively fast sweep/response times.

Table 1
Typical sweep times for narrow frequency spans, showing how rapidly sweep times increase as frequency spans are reduced.

Frequency span	RBW	Sweep rate	Sweep time
100 kHz	1 kHz	500 kHz/s	0.2 s
10 kHz	100 Hz	5 kHz/s	2 s
1 kHz	10 Hz	50 Hz/s	20 s

Figure 3:
The improved shape factor of the digital RBW filters in the PSA series provide better frequency resolution for the same RBW value.

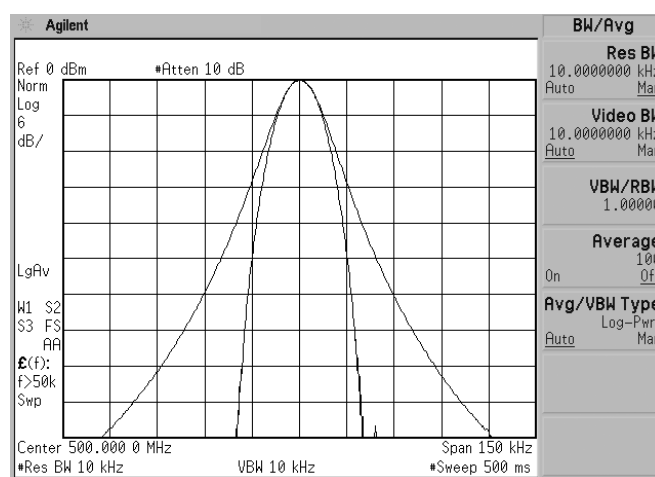

A good compromise between sweep speeds and sweep-induced errors is achieved with the following sweep rate:

$$\text{sweep rate} = 0.5 \times \text{RBW}^2 \text{ [Hz/s]}$$

Note: In some analyzers (this does not apply to the PSA series) the effects of sweeping (at this typical sweep rate) on the RBW filters are not completely included in the amplitude specifications. See the sidebar on page 6 “Faster Sweep Rates and Compensation of Sweep Rate Effects”

For many measurements a useful relationship of frequency span to RBW is approximated by:

$$\text{span/RBW} = 100$$

Combining this equation and the previous one, the slow sweeps required by narrow frequency spans are demonstrated in Table 1.

Similarly, a spurious signal search covering a 1 MHz frequency span and using a 100 Hz RBW filter to achieve a low DANL would require a sweep time of 200 seconds.

Fortunately it is possible to improve on these limitations in several ways by using digital filters. Although sweep effects are seen in both analog and digital filters, filter shapes and characteristics not feasible in analog

technologies can be realized using DSP. The improved characteristics of the digital IF filters in the PSA series can be summarized as follows:

- Improved filter shape factor for better selectivity at every RBW setting
- Finer (10 percent) RBW increments for optimizing RBW/sweep time trade offs
- Predictable dynamic characteristics (response time to envelope variations) which allow magnitude and frequency errors due to sweep rate to be accurately corrected

For example, RBW filters in the PSA series are generally Gaussian in shape, but with an improved shape factor (ratio of 60 dB bandwidth to 3 dB bandwidth) of 4.1:1 vs. the typical 11:1 ratio of analog spectrum analyzer filters. An example is shown in Figure 3.

The benefits of this improved shape factor are best realized when measuring signals with significantly different amplitudes, because a wider (and faster sweeping) RBW value may be selected as compared to traditional analog RBW filters.

Optimizing RBW vs. measurement speed trade offs is also easier in the PSA series because of the RBW flexibility of digital filters. Instead of the typical 1-3-10 RBW sequence of analog filters, the digital filters of the PSA series are implemented in 10 percent increments. This allows the user to select an RBW value that provides adequate resolution and the best possible sweep rate.

Faster Sweep Rates and Compensation of Sweep Rate Effects

In some spectrum analyzers, the effects of sweeping on the RBW filters are not completely included in the amplitude specifications. Therefore the specified amplitude accuracy may only be achieved for sweep times that are 2-4 times slower than those automatically selected by the built-in coupling algorithm, where sweep time is set to “auto”.

The behavior of the PSA series is different in this regard. First, the effects of sweep rate on amplitude measurements are very accurately compensated. However, because the

accuracy specifications of the PSA are so much tighter than its predecessors, the imperfections of its compensations could reduce its accuracy. To resolve this concern, the PSA has a key that controls the swept time auto setting rules. This key, “Auto Sweep Time,” can be set to Norm (normal) or Accy (accuracy) positions. In the Norm setting, precompensated errors in sweeping the RBW and VBW filters are limited to 0.5 dB, while post-compensation errors are typically under 0.05 dB. In the Accy setting, pre-compensation errors are 0.025 dB, and compensations reduce these errors to a negligible part of the total error budget for amplitude accuracy specifications.

Finally, the digital RBW filters in the PSA series are linear phase, with dynamic characteristics that are predictable, stable and repeatable. Therefore these filters can be swept at faster rates, typically given by:

$$\text{sweep rate} = 0.8 \times \text{RBW}^2$$

Faster sweep rates do result in greater amplitude errors. For example, in the previous equation there is a 0.5 dB pre-compensation amplitude error. However, in contrast to those of analog filters, the errors of digital RBW filters can be accurately corrected or compensated for. Thus the faster sweep speeds of the PSA series are not only provided without additional error, they actually result in

less error after precise compensation. See the sidebar above “Faster Sweep Rates and Compensation of Sweep Rate Effects”

Finally, some constraints of swept analysis are independent of the use of analog or digital RBW filters. For example, measurement time for very wide frequency spans depends on how fast the local YIG-tuned oscillator or YIG-tuned preselection filter can be swept. This is typically a consideration for spans in excess of 3 GHz.

Speed of FFT Techniques versus Swept

The primary advantage of FFT analysis is measurement speed in measurements that require a narrow RBW and a comparatively wide frequency span. FFT processing can be modeled as the operation of several hundred RBW filters in parallel. Therefore, although the filter settling time is similar, all of the filters can be settling at the same time and this provides a faster measurement. An example is shown in Table 2.

Note in the table above that sweep time increases linearly as RBW is reduced, rather than as the inverse square of the RBW (as it would for a single swept RBW filter).

Thus, in the case of narrowband analysis an FFT achieves faster speeds by analyzing many frequencies simultaneously. Unfortunately, for wider bandwidths the computational overhead becomes more significant and begins to exceed (and therefore reduce the effect of) the gains from parallel processing. As a consequence, FFT analysis can actually be substantially slower than swept techniques in analyzing wide frequency spans.

FFT analysis is an extremely valuable approach for narrowband analysis where sweep times would otherwise be unacceptably long. A final benefit of FFT analysis in some measurements is its “snapshot” nature, where the spectral display result represents an analysis of the entire frequency span during one time period (the time record or acquisition time). For dynamic signals, whose characteristics could change significantly during a the sweep time of a single swept measurement, this alternative approach may offer some additional insight into the signal.

Table 2
Typical FFT analysis measurement times for narrow frequency spans in the PSA series. Sweep time for a typical spectrum analyzer is shown in the column labeled RBW²/2.

Frequency span	RBW	Measurement time	RBW ² /2
100 kHz	1 kHz	15 ms	0.2 s
10 kHz	100 Hz	31 ms	2 s
1 kHz	10 Hz	196 ms	20 s

Figure 4
Conceptual comparison of relative measurement speeds, including FFT analysis and swept analysis. Swept analysis speeds are shown both for traditional sweep rates and for the increased sweep rates possible by using digital IF filters and compensation of sweep rate effects.

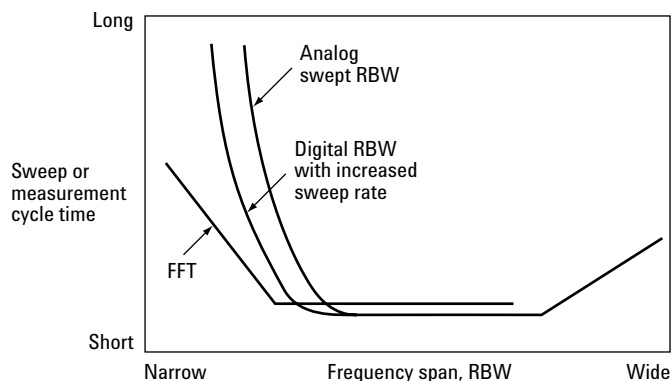

Continuum of Performance Between FFT and Swept Analysis

Considering the benefits of both FFT and swept analysis as described previously, it makes sense to combine them in some fashion. Where both dynamic range and speed are desired, many of the dynamic range benefits of prefiltering and autoranging can be combined with the speed of the FFT technique if multiple narrower FFTs are concatenated to form a single frequency span. The result is a continuum of performance between the dynamic range of the swept technique and the speed of FFT analysis.

When the multiple-FFT approach is used, the results of two or more FFTs are concatenated to provide the spectra for a given span. In such a case the center frequency of each FFT must switch or “hop” from one frequency to the next.

Dynamic Range of the Multiple-FFT Measurement Type

Where multiple FFTs are used to cover a single frequency span, dynamic range can be improved through the use of filtering and autoranging for each FFT segment. For example, if 10 FFTs are used to cover a single frequency span, the prefilter bandwidth can be set to a value only 1/10 as wide as that of that for a single FFT, thereby significantly improving dynamic range. Similarly, the 10 FFTs provide 10 opportunities for autoranging to track the magnitude of the spectra in the measured frequency span. With each range change, the dynamic range can increase by the amount of the allowable range change.

Figure 6: Comparison of measurement cycle times for different measurement types in the PSA series.

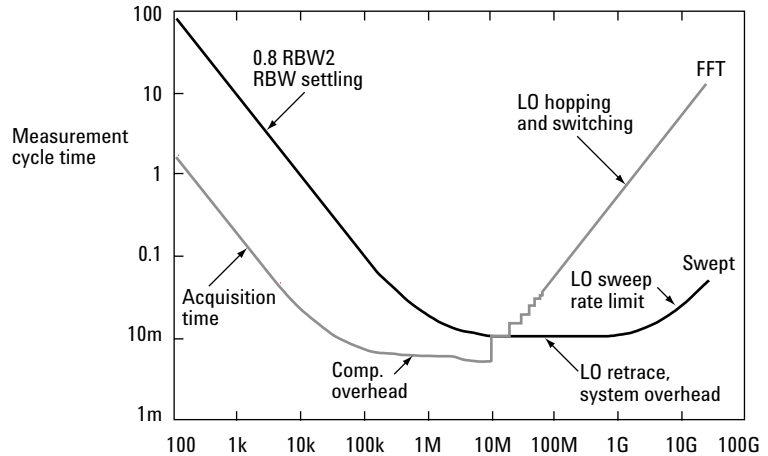

Measurement Speed of the Multiple-FFT Measurement Type

The measurement speed of a multiple FFT measurement will not be as fast as it would be for a single FFT. However the speed benefits provided by FFT analysis for narrow RBWs are so large that they are worthwhile in many instances, even after reduction by the processes involved in performing multiple FFTs.

When using multiple FFTs for each frequency span, overall measurement speed is determined by several factors, including data acquisition time, processing time, and LO switching time. For narrow-band analysis, the data acquisition time is about 1.83/RBW. Sweep rate is therefore given by the product of the sweep rate for each FFT and the number of FFTs:

$$\text{Sweep rate} = \frac{\text{frequency span}}{(\#\text{FFTs}/\text{span}) \times (1.83/\text{RBW} + \text{LO hop time})}$$

This method is faster than swept analysis for narrow frequency spans. Relative measurement speeds (expressed as measurement cycle time) are summarized in Figure 6.

In the graph of figure 6 the flat portion of the FFT analysis curve indicates the computation time for FFTs due to processor overhead and LO frequency switching. The sloping portion on the right side of the graph indicates the time needed for center frequency switching during wide frequency spans. The LO settling time dominates in this region. These factors are compared to the measurement speed of swept measurements in the PSA series, with its faster sweep rates and compensation of sweep rate effects. See the sidebar on page 6 “Faster Sweep Rates and Compensation of Sweep Rate Effects”

Automatic Selection of Sweep Type

In the PSA series' autocoupled mode, where the analyzer automatically selects sweep type, the user can select between two different optimization algorithms. One emphasizes dynamic range and the other places the priority on measurement speed. If speed optimization is selected, the analyzer's choice of FFT or swept analysis is made on the basis of resolution bandwidth. Typically the analyzer will choose FFT analysis for RBWs below 10 kHz and swept analysis for RBWs of 10 kHz and above.

If dynamic range optimization is selected, the analyzer automatically chooses swept analysis unless the FFT dynamic range is unlikely to be compromised. Accordingly, FFT analysis is chosen for RBWs of 200 Hz and below, and the analyzer makes further choices in terms of the number of FFTs used to cover the selected frequency span. The automatic choice of number of FFTs/span is made in such a way that the bandwidth of each FFT is 5 kHz or narrower. Because hardware limitations constrain the prefilter to a 5 kHz minimum in both swept and FFT analysis, the prefiltering is about as effective for FFTs covering these narrow bandwidths as it is for similar swept measurements.

Figure 7
The same pulsed RF signal is measured using swept (digital IF) and FFT techniques. In this case the FFT technique uses a single FFT to cover the entire frequency span and this configuration offers the greatest speed benefit. However the trade-off is in dynamic range, where the swept measurement is clearly superior.

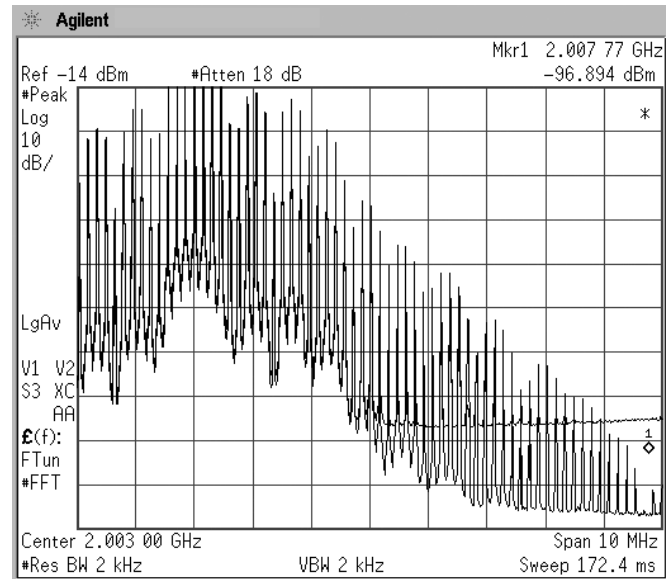

Manual Selection of Sweep Type

Sweep types may also be selected manually, to optimize speed, dynamic range, or accuracy. Swept analysis typically provides the greatest accuracy, even for narrow RBWs. Where measurement speed or dynamic range are the primary concerns, the following measurement examples will describe how performance varies, based on whether FFT or swept analysis is used, and on how many FFT segments are used to cover the selected frequency span.

In Figure 7, the blue trace (the one with the higher noise level) is the result of an FFT measurement where a single FFT was used to cover the entire frequency span (FFTs/span set to 1). The yellow trace (lower noise level) is the result obtained from a swept measurement. Both measurements are of the same pulsed RF signal. The dynamic range of the swept measurement is clearly better than that of the FFT measurement—approximately 20 dB better at some frequencies. Thus the swept measurement reveals some portions of the signal that would normally be hidden by the noise floor of a measurement made using a single FFT. However the measurement speed of the swept measurement is much slower—about 3.1 seconds vs. 0.172 seconds for the single-FFT measurement.

Figure 8 shows the result of another FFT measurement of the same pulsed RF signal. In this measurement 5 FFTs are used to cover the frequency span (FFTs/span set to 5). An FFT measurement performed in this way provides a combination of dynamic range and measurement speed benefits, though neither of these measurement characteristics is fully optimized.

The flexible measurement choices in the PSA series provide a continuum of measurement performance in the areas of dynamic range, accuracy and measurement speed. This continuum is further described by the examples in the table 3.

Note that the relationship of dynamic range to sweep time is highly non-linear, providing an opportunity for multiple-FFT measurements to significantly improve dynamic range with only a modest increase in sweep time. Samples of the performance continuum described here are shown graphically in Figure 9.

Figure 8: The same pulsed RF signal of Figure 7 is measured here using the FFT technique with 5 FFTs covering the frequency span. The result is a compromise between the dynamic range of swept analysis and the maximum potential speed of FFT analysis (using a single FFT to cover the frequency span).

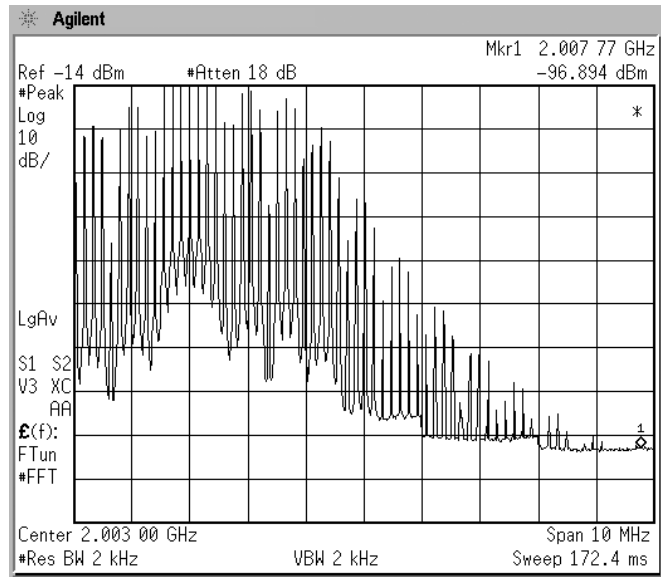
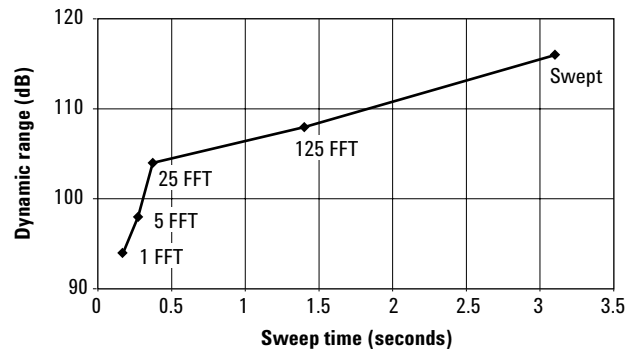

Table 3
Comparison of sweep time vs. dynamic range for measurement of a pulsed RF signal

Sweep type	Dynamic range	Sweep time
Swept	116 dB	3.1 s
FFT, 25 FFTs/Span	108 dB	1.4 s
FFT, 5 FFTs/Span	104 dB	0.37 s
FFT, 3 FFTs/Span	98 dB	0.27 s
Single FFT	94 dB	0.17 s

Figure 9: Making the best trade-off between dynamic range and measurement speed for a particular application is facilitated by the availability of both FFT and swept analysis in the PSA series. Note that FFT measurements using multiple FFTs/span provide an adjustable compromise between speed and dynamic range.



Conclusion

The PSA series spectrum analyzers offer an exceptional combination of measurement speed, dynamic range, and accuracy. For optimum performance in a particular measurement it may be useful to trade off one or more of these three parameters, and the architecture of the PSA series supports this optimization.

Both swept analysis (using an all-digital implementation of a swept spectrum analyzer IF section) and FFT analysis are available in the PSA series. Several major innovations are included in the PSA series to provide the maximum benefits from these two analysis types:

- Three measurement types including swept analysis, FFT analysis, and multiple segment FFT type.
- A sophisticated autocoupling algorithm that provides a high degree of optimization without the need for user intervention, along with other optimizing modes where the user can focus on a particular measurement parameter to improve.
- Complete manual control of measurement characteristics when a particular measurement setup is required.

References

Optimizing Dynamic Range for Distortion Measurements

Product Note

Literature number 5980-3079EN

Amplitude Accuracy Product Note

Literature number 5980-3080EN

Measurement Innovations and Benefits Product Note

Literature number 5980-3082EN

Digital Implementation of a Swept Spectrum Analyzer IF Section, Applied Microwaves & Wireless Magazine, December 2000.

Specifications

Frequency coverage	3 Hz to 26.5 GHz
DANL	-153 dBm (10 MHz to 3 GHz)
Absolute accuracy	±0.27 dB (50 MHz)
Frequency response	±0.40 dB (3 Hz to 3 GHz)
Display scale fidelity	±0.07 dB total (below -20 dBm)
TOI (mixer level -30 dBm)	+16 dBm (400 MHz to 2 GHz) +17 dBm (2–2.7 GHz) +16 dBm (2.7–3 GHz)
Noise sidebands (10 kHz offset)	-113 dBc/Hz (CF = 1 GHz)
1 dB gain compression	+3 dBm (200 MHz to 6.6 GHz)
Attenuator	0–70 dB in 2 dB steps

Related Literature for the Agilent PSA Performance Spectrum Analyzer Series

PSA Brochure

Literature number 5980-1283E

PSA Spectrum Analyzer Series Data Sheet

Literature number 5980-1284E

Optimizing Dynamic Range for Distortion Measurements, Application Note

Literature number 5980-3079EN

Amplitude Accuracy Application Note

Literature number 5980-3080EN

Measurement Innovations and Benefits Application Note

Literature number 5980-3082EN

Select the Right PSA Spectrum Analyzer for Your Needs Selection Guide

Literature number 5968-3413E

Self-Guided Demonstration Technical Overview

Literature number 5988-0735EN

Warranty

The E4440A is supplied with a 1 year warranty.

Visit our web site at:

www.agilent.com/find/psa

Agilent Technologies' Test and Measurement Support, Services, and Assistance

Agilent Technologies aims to maximize the value you receive, while minimizing your risk and problems. We strive to ensure that you get the test and measurement capabilities you paid for and obtain the support you need. Our extensive support resources and services can help you choose the right Agilent products for your applications and apply them successfully. Every instrument and system we sell has a global warranty. Support is available for at least five years beyond the production life of the product. Two concepts underlie Agilent's overall support policy: "Our Promise" and "Your Advantage."

Our Promise

Our Promise means your Agilent test and measurement equipment will meet its advertised performance and functionality. When you are choosing new equipment, we will help you with product information, including realistic performance specifications and practical recommendations from experienced test engineers. When you receive your new Agilent equipment, we can help verify that it works properly and help with initial product operation.

Your Advantage

Your Advantage means that Agilent offers a wide range of additional expert test and measurement services, which you can purchase according to your unique technical and business needs. Solve problems efficiently and gain a competitive edge by contracting with us for calibration, extra-cost upgrades, out-of-warranty repairs, and onsite education and training, as well as design, system integration, project management, and other professional engineering services. Experienced Agilent engineers and technicians worldwide can help you maximize your productivity, optimize the return on investment of your Agilent instruments and systems, and obtain dependable measurement accuracy for the life of those products.

Agilent T&M Software and Connectivity

Agilent's Test and Measurement software and connectivity products, solutions and developer network allows you to take time out of connecting your instruments to your computer with tools based on PC standards, so you can focus on your tasks, not on your connections. Visit www.agilent.com/find/connectivity for more information.

For more information on Agilent Technologies' products, applications or services, please contact your local Agilent office. The complete list is available at:

www.agilent.com/find/contactus

Phone or Fax

United States:

(tel) 800 829 4444
(fax) 800 829 4433

Canada:

(tel) 877 894 4414
(fax) 800 746 4866

China:

(tel) 800 810 0189
(fax) 800 820 2816

Europe:

(tel) 31 20 547 2111

Japan:

(tel) (81) 426 56 7832
(fax) (81) 426 56 7840

Korea:

(tel) (080) 769 0800
(fax) (080)769 0900

Latin America:

(tel) (305) 269 7500

Taiwan:

(tel) 0800 047 866
(fax) 0800 286 331

Other Asia Pacific

Countries:

(tel) (65) 6375 8100
(fax) (65) 6755 0042

Email: tm_ap@agilent.com

Contacts revised: 9/17/04



Agilent Email Updates

www.agilent.com/find/emailupdates

Get the latest information on the products and applications you select.

Product specifications and descriptions in this document subject to change without notice.

© Agilent Technologies, Inc. 2004, 2000
Printed in USA, October 19, 2004
5980-3081EN



Agilent Technologies