

Agilent PSA High-Performance Spectrum Analyzer Series

Amplitude Accuracy

Product Note

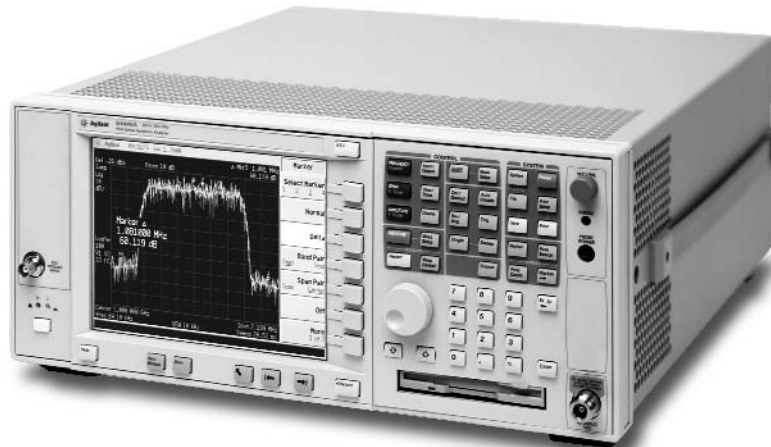

Accurate measurement of signal power level is critical in modern communications systems. Specifications and margins are very important, whether one is analyzing circuits, subsystems or complete communications links. Better amplitude accuracy can translate into faster design time, more decisive troubleshooting, higher yield, better power efficiency, tighter specification of the customer's device, etc.

For a single frequency signal, power meters achieve the best amplitude accuracy. When multiple signals are involved, spectrum analyzers are very useful because of their frequency

selectivity. This frequency selectivity enables the user to isolate a particular signal and exclude other signals from a measurement.

This product note identifies possible sources of amplitude uncertainty in traditional spectrum analyzers. It then compares traditional spectrum analyzer performance with that of the Agilent PSA Series high-performance spectrum analyzer (model E4440A).

The PSA Series offers several technical innovations—precision flatness calibration, an all digital intermediate frequency (IF)

section, and internal calibrators—that make measurements more accurate, faster, and easier. This product note describes these innovations and provides some example measurements.

The PSA Series is not intended to completely replace power meters, although it can replace power meters in some applications where spectrum analysis is also needed. In addition, the PSA Series is frequency-selective and has the ability to isolate one signal from others and to measure that signal with high accuracy, similar to a power meter. This makes it an ideal tool for communications applications.

Table of Contents	
Sources of Amplitude Uncertainties in Traditional Spectrum Analyzers	3
Sources of relative amplitude uncertainty in a traditional spectrum analyzer	3
Sources of absolute amplitude uncertainty in a traditional spectrum analyzer	5
Repeatability uncertainty in a traditional spectrum analyzer	5
Temperature drift in a traditional spectrum analyzer	5
Post-tuning drift in a traditional spectrum analyzer	5
PSA Series Improvements in Amplitude Accuracy	6
Flatness	6
Digital IF section	6
IF effects on amplitude accuracy in a traditional spectrum analyzer	7
1. IF gain	7
2. Log amplifier	8
3. Bringing the measured signal to the reference line	8
IF effects on amplitude accuracy in the PSA Series	9
1. IF gain	9
2. Log-linear fidelity uncertainty	10
3. Dithering	11
4. Power bandwidth uncertainty	12
Internal calibrator	13
Testing and specifying calibration	13
Comparing Amplitude Accuracy Specifications of the PSA Series and the Agilent Technologies 8563E	14
Examples of the Measurement Uncertainties in Typical Amplitude Measurements	15
Example 1. Signal power measurement (absolute measurement)	15
Example 2. Relative measurement (using the delta marker) of signals in different bands	16
Example 3. Third-order distortion measurement (relative measurement)	17
Example 4. Mismatch measurement error and measurement uncertainty	18
Summary	19
References	19
Glossary of Terms	20
Specifications	21
Support, Services, and Assistance	22

About the Agilent PSA Series high-performance spectrum analyzer

The Agilent PSA Series is a high-performance radio frequency (RF) and microwave line of spectrum analyzers that offers an exceptional combination of dynamic range, accuracy, and measurement speed. The PSA Series delivers the highest level of measurement performance available in the Agilent Technologies spectrum analyzer portfolio. An all-digital intermediate frequency (IF) section includes fast Fourier transform (FFT) analysis and a digital implementation of a swept IF. The digital IF and innovative analog design provide much higher measurement accuracy and improved dynamic range compared to traditional spectrum analyzers. This performance is combined with measurement speed typically 2 to 50 times faster than spectrum analyzers using analog IF filters.

The PSA Series complements Agilent's other spectrum analyzers such as the MXA Series, a family of midrange analyzers that covers a variety of RF and microwave frequency ranges while offering a great combination of performance, speed, and applications.

Sources of Amplitude Uncertainties in Traditional Spectrum Analyzers

The amplitude accuracy of spectrum analyzers is specified in terms of both absolute accuracy and relative accuracy. Absolute amplitude is the power level of a signal in absolute units such as dBm. Relative amplitude is the difference between two signal levels, using one signal level as a reference. For example, in a two tone intermodulation measurement, we use the fundamental signal as a reference and measure the third order intermodulation products using decibels relative to the carrier level in dBc units. Figure 1, a traditional spectrum analyzer block diagram, identifies possible sources of amplitude uncertainties.

Sources of relative amplitude uncertainty in a traditional spectrum analyzer

Because other literature discusses spectrum analyzer amplitude accuracy in detail, this product note will just mention each uncertainty and give a brief explanation. Please refer to References 1 and 2 on page 19 for detailed explanations.

Frequency response (flatness)

Frequency response, or flatness, is the relative amplitude uncertainty versus frequency over a specified frequency range. It is a function of input attenuator flatness and mixer conversion loss; both of these are frequency range dependent, and calibrated with respect to the analyzer's calibration frequency.

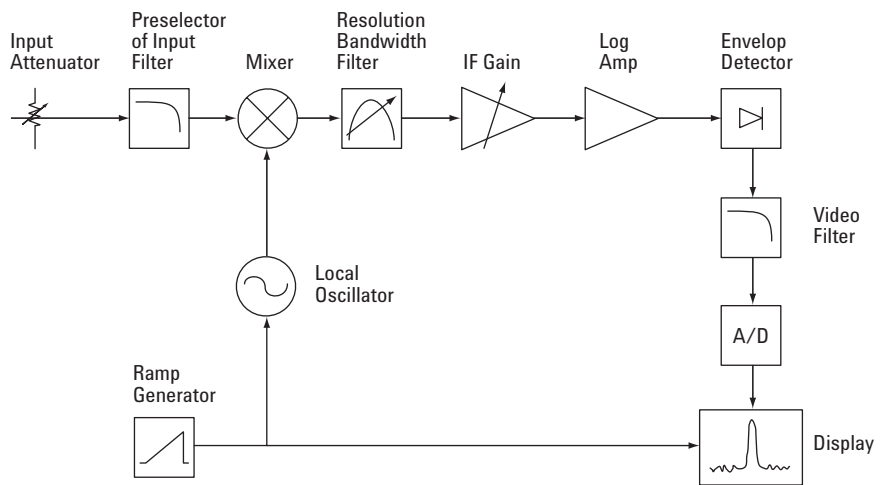

Figure 1. Traditional spectrum analyzer block diagram

In the newest generation of Agilent spectrum analyzers (MXA and PSA Series), this calibration frequency has been converged to 50 MHz, the same frequency as the calibrator signal of power meters.

Flatness in preselected bands (usually above 3 GHz) is also dependent on the sweep rate (SR) due to errors in keeping the Yttrium Iron Garnet-tuned (YIG-tuned) filter (also known as the YTF) preselector aligned to the tuned frequency. Some errors in tuning the filter are compensated by modeling them as a delay between the frequency control and the center frequency. YTF delay compensation is not perfect, so the sweep rate (SR = span/sweep time) should not be larger than the YTF delay

compensation allowed. In the PSA Series, the maximum sweep rate is limited by local oscillator (LO) and YTF capabilities to 600 MHz/ms for band 0 to band 2 (up to 13.2 GHz); for band 3, SR = 500 MHz/ms; and for band 4, SR = 400 MHz/ms.

Band switching error

A microwave spectrum analyzer uses several frequency bands. These bands use different mixer paths and different LO harmonics. When signals in different bands are measured, uncertainties arise when the analyzer switches from one band to another. In the PSA E4440A, there are five internal mixing bands: 3 Hz to 3.0 GHz; 2.85 GHz to 6.6 GHz; 6.2 GHz to 13.2 GHz; 12.8 GHz to 19.2 GHz; and 18.7 GHz to 26.5 GHz.

Sources of Amplitude Uncertainties in Traditional Spectrum Analyzers (continued)

Scale fidelity (log fidelity or linear fidelity)

Scale fidelity, the uncertainty of the observed signal level with respect to a reference level, depends on the linearity of the envelope detector and linearity (log fidelity) of logarithmic amplifiers.

Reference level accuracy

When a spectrum analyzer is calibrated, the reference level is traditionally defined by the amplitude represented at the top line of the graticule on the display. The amplitude of the top graticule is a function of the input (RF) attenuation level and the IF gain, which are determined by the reference level control. Uncertainty in the amount of IF gain at a particular reference level control setting affects the accuracy of the reference level amplitude. When a known signal standard is used to calibrate the reference level, calibrator uncertainty is substituted for reference level control uncertainty. Any subsequent change in the reference level control introduces uncertainty into the measurement.

RF input attenuator switching error

Attenuator step accuracy, like frequency response, is a function of frequency. If the attenuator is changed between the reference and measurement positions, it will introduce uncertainty in the measurement. For the PSA Series, like many spectrum analyzers, the input attenuator reference setting is 10 dB.

Resolution bandwidth (RBW) switching

The available resolution bandwidth filters of a spectrum analyzer have uncertainty associated with their relative insertion loss. As a result, if a signal is measured using different resolution bandwidths, the measured amplitudes may differ. Whenever the resolution bandwidth setting is changed between calibration and measurement, the accuracy is degraded and measurement accuracy is compromised. The reference resolution bandwidth for the PSA Series is 30 kHz.

Noise effect on signal amplitude

At any point in a measurement, the spectrum analyzer is measuring the sum of all signal energy present in the IF passband. Therefore, the measured amplitude of the signal is actually signal plus noise. Depending upon the signal level relative to the noise level, the inaccuracy in assuming that the “measured” amplitude equals the “signal” amplitude may be small or large. Please refer to Reference 3 on page 19 for a more detailed explanation.

Impedance mismatch

Spectrum analyzers do not have perfect input impedance, nor do most signal sources have ideal output impedance. Impedance mismatches produce reflections, which reduce the signal power transferred to the analyzer and introduce a measurement uncertainty. The general expression used to calculate mismatch error limits in dB is:

$$-20 \times \log_{10} (1 \pm | \rho_{\text{analyzer}} \times \rho_{\text{source}} |)$$

Where ρ is the reflection coefficient.

As described in the equation, this mismatch error depends on both the spectrum analyzer input impedance and the output impedance of the signal source. The use of attenuation at the input of the analyzer improves the input impedance match. This is why the reference setting of the spectrum analyzer input attenuator is 10 dB. For best amplitude accuracy, use an input attenuator ≥ 10 dB.

This mismatch error can be quite large. See Example 4 on page 18, for an illustration of this error.

Sources of Amplitude Uncertainties in Traditional Spectrum Analyzers (continued)

Sources of absolute amplitude uncertainty in a traditional spectrum analyzer

Calibrator accuracy gives a spectrum analyzer its absolute amplitude reference. For convenience, calibrators are typically built into today's spectrum analyzers and provide a signal with specified amplitude at a convenient frequency. The relative accuracy of the analyzer is used to translate the absolute calibration to other frequencies and amplitudes. In the PSA Series, the internal calibrator is set at a frequency of 50 MHz and a level of -25 dBm.

Repeatability uncertainty in a traditional spectrum analyzer

Mechanical switches can cause a lack of repeatability. In many spectrum analyzers, the calibrator switch and input attenuator use mechanical relays. (Some degree of amplitude repeatability uncertainty is an unavoidable consequence of mechanical switches.)

Temperature drift in a traditional spectrum analyzer

Temperature drift is caused by changes in IF amplifier gain with temperature. Traditionally, amplitude accuracy specifications must be relaxed over a wide temperature range to account for this drift.

Post-tuning drift in a traditional spectrum analyzer

Self-heating of the YIG-based highband preselector filter causes a frequency shift of the filter, which leads to changes in the displayed signal amplitude.

PSA Series Improvements in Amplitude Accuracy

In the PSA Series, the design and production processes have been fundamentally changed in ways that minimize most of the measurement uncertainties described previously.

The major changes include: a precision flatness calibration process, an internal calibrator, and an all digital IF.

Flatness

In a spectrum analyzer, the frequency response of the input section components, such as input attenuators and the first mixer, creates amplitude variations with frequency.

In the PSA Series design, a precision flatness calibration method corrects frequency response errors.

This method greatly improves the “absolute flatness” accuracy, that is, the flatness relative to the frequency of the absolute accuracy reference—in this case, the 50 MHz calibrator signal.

With some spectrum analyzers the flatness of some bands relative to the calibrator is not particularly well controlled. In these analyzers, the relative gain uncertainty between signals in two bands can be specified as the sum of the relative flatness in each band plus the band-switching uncertainty. Such analyzers may be specified more tightly this way than as the sum of the flatness errors relative to the calibrator of the signals for both bands. In the PSA Series, the flatness relative to the calibrator is very well controlled in all bands. As a consequence, no specification

improvement is possible using the band switching uncertainty concept and there is no such specification.

Figure 2 shows a typical frequency response of the PSA Series E4440A for frequencies below 3 GHz. The specification limits of flatness for frequencies below 3 GHz are ± 0.40 dB. Note how well controlled the frequency response errors are, and compare the typical response to the specification limits.

Digital IF section

A comparison of a traditional analog IF section with the all digital IF section in the PSA Series highlights the advantages of the technology used in the PSA Series.

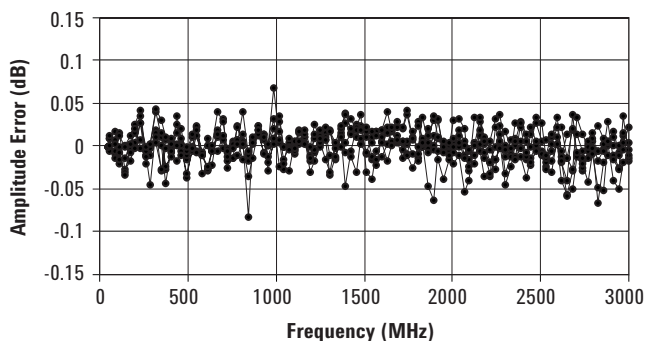

Figure 2. PSA E4440A flatness cal data typical frequency response

PSA Series Improvements in Amplitude Accuracy (continued)

IF effects on amplitude accuracy in a traditional spectrum analyzer

It is instructive to understand why moving the signal under test to the reference level is necessary in a traditional spectrum analyzer to achieve better amplitude accuracy. This is illustrated in the block diagram in Figure 3.

In Figure 3, we can see that the traditional spectrum analyzer analog IF section is composed of an analog IF amplifier followed by a log amplifier.

As explained in the “Reference level accuracy” section on page 4, the top line of the graticule on the display is defined as the reference

level. A known calibration signal can be used to calibrate this reference line. Thus the calibrator determines the absolute accuracy for the top line of the graticule at a particular analog IF gain setting and input signal power level to the log amplifier. The reference level is the most accurately indicated level because it is the calibrated level.

A traditional spectrum analyzer has only one calibrator level and one reference input attenuator setting, typically 10 dB.

Therefore, only one reference level can be optimally calibrated, unless additional external calibration levels are used.

1. IF gain

The reference level control determines the IF gain. When the analyzer is calibrated, the reference level is set to the calibrator level, and the uncertainty of the IF gain is calibrated out. However, any changes to the reference level from that used for calibration will affect the IF gain setting and consequently introduce uncertainty to the signal amplitude measurement.

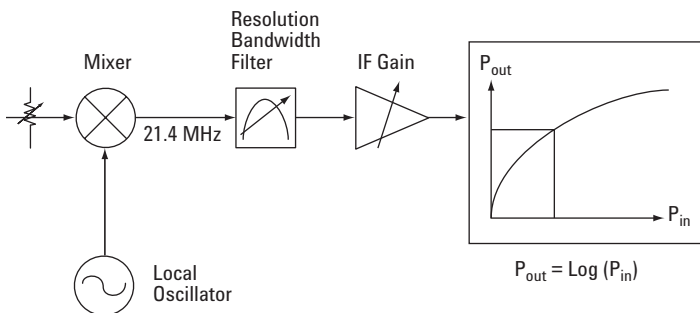

Figure 3. Block diagram of a traditional spectrum analyzer analog IF section

PSA Series Improvements in Amplitude Accuracy (continued)

2. Log amplifier

In order to display a wide dynamic range signal, spectrum analyzers use a logarithmic vertical scale in the display. As shown in Figure 1 on page 3, there is a log amplifier in the traditional specification analyzer block diagram. The log amplifier is used to display the signal power level on the vertical axis of the display.

Most log amps are realized by physical components in a traditional spectrum analyzer. These components have performance limitations and uncertainty, resulting in log fidelity error such as that shown in Figure 4.

3. Bringing the measured signal to the reference line

Because the calibrator operates at a single frequency and fixed signal power level, the reference level setting is calibrated for just one particular setting of the IF gain. For most signal amplitude measurements, the signal under test will be at a different frequency as well as a different amplitude.

To measure a signal with a power level different from the calibrator, we can either change the IF gain to a value different from the calibrated gain, or we can read the signal level at a drive level to the log amplifier that is not the reference level. For some

spectrum analyzers, the log fidelity has much larger uncertainty than IF gain uncertainty. When these spectrum analyzers are used, the lowest uncertainty is achieved if the IF gain is changed in order to bring the unknown signal level to the reference level, thus driving a constant input signal level to the log amplifier. For other spectrum analyzers, where the IF gain uncertainty is a larger uncertainty than the log fidelity, the lowest uncertainty is achieved by keeping the IF gain (and thus the reference level) fixed at the calibrated setting, and allowing the drive level to the log amplifier to change.

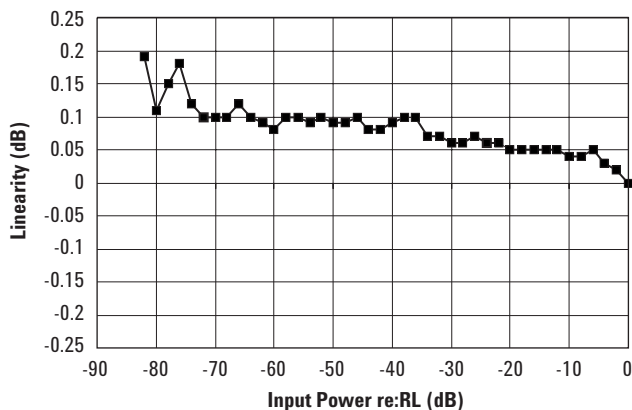

Figure 4. Typical log fidelity error in a traditional spectrum analyzer

PSA Series Improvements in Amplitude Accuracy (continued)

IF effects on amplitude accuracy in the PSA Series

In the PSA Series, an all digital IF section is used, which eliminates or minimizes many traditional amplitude uncertainties such as log fidelity error, IF gain uncertainty, and resolution bandwidth (RBW) switching error. The block diagram in Figure 5 shows the implementation of digital IF technology in the PSA Series.

In Figure 5, we can see that the IF section of the PSA Series is composed of an analog to digital converter (ADC) and digital signal processing (DSP). The DSP

is implemented in an application specific integrated circuit (ASIC) chip, which includes digital RBW filtering, a digital log amplifier, a digital video bandwidth (VBW) filter, and digital display detectors (such as peak, normal, sample, etc).

1. IF gain

None of the stages shown in Figure 5 have gain that changes with the reference level. All of the operations are performed digitally. Therefore, there is no IF gain uncertainty. A major benefit to the user is the ability to change the reference level for the best display without affecting the measurement accuracy.

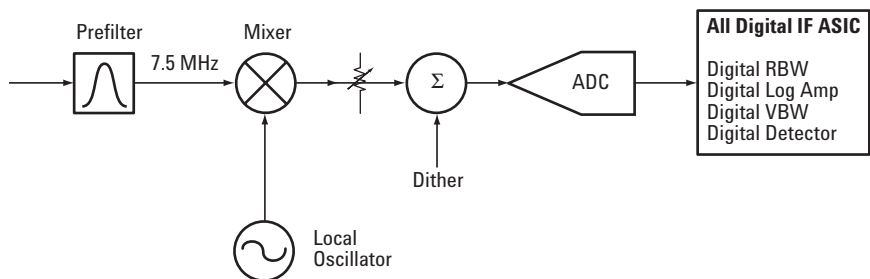

Figure 5. Block diagram of the PSA Series IF section

PSA Series Improvements in Amplitude Accuracy (continued)

2. Log-linear fidelity uncertainty

The specifications of the PSA Series for amplitude accuracy include display scale fidelity. The specification indicates log-linear fidelity relative to -35 dBm at the input mixer. However, as mentioned previously, there is no log amplifier in the PSA Series, and so the source and magnitude of this error require explanation.

In the PSA Series, the log function is done mathematically and traditional log fidelity uncertainty does not exist. But there are other sources of errors in the PSA Series that cause log-linear fidelity uncertainty. This uncertainty comes from two sources: RF compression

(especially for input signal levels above -20 dBm) and ADC range gain alignment limitations.

The log fidelity is specified at ± 0.07 dB for any signal level up to -20 dBm at the input mixer of the analyzer, and ± 0.13 dB for signal levels up to -10 dBm at the input mixer. Figure 6 shows typical log fidelity error in the PSA Series.

In Figure 6 we see that for signal levels at the input mixer above -20 dBm, there are some log fidelity uncertainties well within the specified ± 0.13 dB. For signal levels at the input mixer in the range of -80 dBm to -20 dBm, log fidelity error is inside the range of ± 0.07 dB. For signal levels at

the input mixer below -80 dBm (signal levels close to the spectrum analyzer noise floor) the log fidelity error uncertainties are mostly due to noise. Thus these are not log fidelity errors; there is no apparent limitation to low-level log fidelity except system noise.

Traditional spectrum analyzers have similar uncertainty sources, but the log amplifier error dominates the total log fidelity uncertainty. Log fidelity error caused by first mixer compression is too small to be significant in the log fidelity uncertainty of traditional spectrum analyzers.

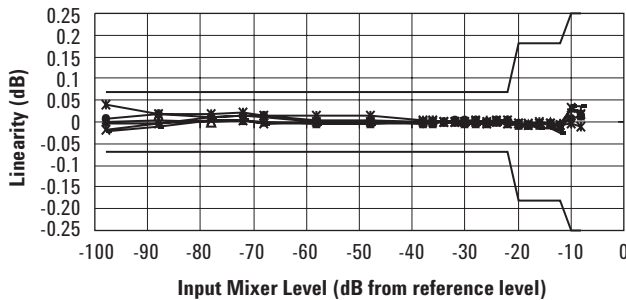

Figure 6. Input power versus typical log fidelity error with dither

PSA Series Improvements in Amplitude Accuracy (continued)

3. Dithering

All ADCs have errors in linearity, and even an ADC with perfect linearity would have quantization errors. When the signal level is small, the quantization errors can dominate the amplitude uncertainty. Figure 7 shows ideal ADC transfer function (input vs. output relationship) with and without noise added at the input.

Figure 7 also shows that if an input sine wave is applied to this ADC with less than 1 least significant bit (LSB) peak-to-peak level, the output is a constant zero, giving an amplitude error of an infinite number of decibels. Input signals from 1 to 2 LSBs peak-to-peak produce output levels that vary by much less than

the 6 dB of input range. These examples demonstrate why quantization errors can result in very large linearity errors. In a spectrum analyzer, these errors are part of “log or linear fidelity” error terms, the relative accuracy of the detection of different signal levels.

However, if the input signal has noise added, the average of the transfer function is smoothed, as shown in Figure 7, because signal levels near bit transitions occasionally yield results across the bit transition. Analytically, the average transfer function is the convolution of the noiseless transfer function with the probability density function (PDF) of the noise. If the added

noise is much larger than a most significant bit (MSB), the linearity can be excellent.

This added noise is called dither. In the PSA Series, the dither is applied at frequencies outside the range of IF analysis so it is not normally visible on the screen. Used in this way, it acts to convert the quantization distortion (errors that would be correlated with the signal) into uncorrelated errors, which would then act as quantization noise. But the dither used is so large that the maximum input signal must be reduced, compromising the S/N ratio. The displayed average noise level gets worse by about 2.5 dB.

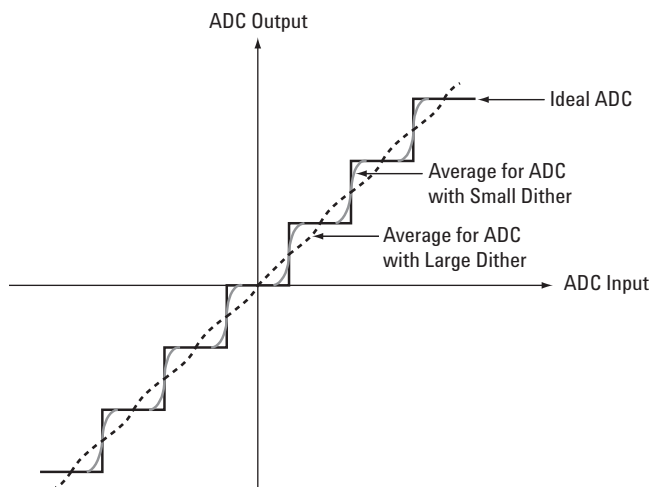

Figure 7. Ideal ADC: Input-output relationship

PSA Series Improvements in Amplitude Accuracy (continued)

In the PSA Series, the user may choose from the **Mode Setup** (front panel key) for dither on, dither off, or automatic selection of dither. When the dither is off, the low-level linearity is poorer, but still nominally within about ± 0.2 dB. When the dither is on, the increased noise floor of the analyzer can cause measurement errors. But even with a noise floor increase as large as 2.5 dB, versus a detection linearity improvement from only ± 0.2 dB to ± 0.07 dB, the total measurement error, on average, is lower with dither on, unless the signal is actually lower than the noise floor. Figure 6 on page 10 shows the log fidelity error with dithering on and Figure 8 shows the log fidelity error with dithering off.

A comparison of Figure 6 and Figure 8 shows that, at low input signal levels, log fidelity error improves substantially when dithering is used.

In the PSA Series, it is generally recommended that dither be used when the measured signal has a $S/N \geq 10$ dB. When the S/N is under 10 dB, the degradations to accuracy of any single measurement (in other words, without averaging) that come from a higher noise floor are worse than the linearity problems solved by adding dither, so dither is best turned off.

4. Power bandwidth uncertainty

In the measurement of noise density or the measurement of the total power of a noise-like signal, the accuracy of the bandwidth of the RBW filters has significant effects on amplitude accuracy.

In the PSA Series, the analog prefilter is set to about 2.5 times the RBW width. It will have some uncertainty in bandwidth, gain, and center frequency with different RBW settings. Figure 5 on page 9 shows that there is no further analog RBW filtering and log amplification in the IF section of the PSA Series.

Although the analog prefilter affects the shape of the total RBW filtering, most of the filtering is done digitally in an ASIC in the digital IF section. The digital filtering is very repeatable, but it cannot be set with perfect resolution. Typical RBWs in the PSA Series have a bandwidth within 1.2 percent of the selected bandwidth.

In any case, the resolution of the digital filtering is accurately known in the PSA Series. Therefore measurements of noise-like signals can be compensated for the digital filter bandwidth, leaving only the uncertainty of the analog prefilter as a bandwidth error. This prefilter is well characterized and has only a small effect on the total bandwidth because its bandwidth is significantly wider than the selected RBW (nominally 2.5 times wider).

As a result, the accuracy of measurements that depend on the bandwidth of the RBW filter are as accurate as those made with a filter with only ± 1.0 percent bandwidth uncertainty, or an equivalent error of ± 0.044 dB compared with those made using an ideal filter. Previous generations of spectrum analyzers had RBW width accuracies of 10 to 20 percent.

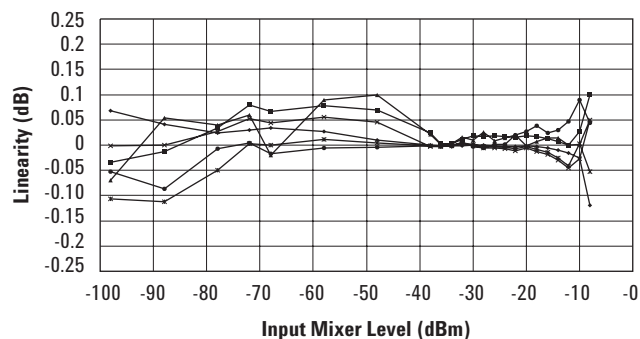

Figure 8. Typical log fidelity error with dithering off

PSA Series Improvements in Amplitude Accuracy (continued)

Internal calibrator

The calibrator of a spectrum analyzer provides a convenient absolute power level. The absolute accuracy of any spectrum analyzer measurement may be determined by adding the calibrator error to any other uncertainties that arise from settings that deviate from the calibration setting.

The calibrator in the PSA Series is different from previous generations in three ways: level, frequency, and cabling.

The calibrator level is -25.0 dBm. This level is low enough (-35.0 dBm at the input mixer) that it can serve as the reference point for scale fidelity specifications without significant errors due to gain compression in the analyzer circuits.

The calibrator frequency is 50 MHz. This calibration frequency is now common in the latest generation of analyzers. The 50 MHz frequency helps traceability because most

production facilities, including those of Agilent Technologies, trace their amplitude accuracy to the National Institute of Standards and Technology (NIST) through power meters, and power meters use 50 MHz for their calibrators. If the reference frequency of the power meter is the same as the analyzer reference frequency, the frequency response flatness accuracy term in the power meter error budget does not apply. Therefore traceability has a lower error at 50 MHz than at any other frequency.

The PSA Series has an internal calibrator, so no external cable is involved. Calibration is therefore as convenient as pressing keys.

Testing and specifying calibration

Previous generation analyzers, with externally cabled amplitude calibration signals, specified separately the absolute accuracy of the calibrator. The total absolute accuracy was the sum of the errors of the calibrator and

the errors due to differences in analyzer settings between the calibration and measurement settings.

The PSA Series specifies many amplitude uncertainties separately, but, for absolute amplitude accuracy, it specifies the sum of many errors. Over a broad range of RBWs and signal levels, for any reference level and display scale, the PSA Series specifies a single parameter: absolute amplitude uncertainty at 50 MHz. This specification of ± 0.24 dB is verified in the factory by testing a set of 43 conditions that should exercise the worst errors.

This specification substitutes for the following parameters in older analyzers: calibrator error, log-linear fidelity uncertainty, IF gain uncertainty, and RBW switching error. In a typical measurement, the user needs to only add flatness and, possibly, attenuator switching uncertainty to get the total absolute accuracy.

Comparing Amplitude Accuracy Specifications of the PSA Series and the Agilent Technologies 8563E

This section compares some of the major differences in amplitude accuracy specifications between the PSA E4440A and the Agilent 8563E. For detailed specifications for the PSA E4440A, please refer to Reference 4 on page 19 or www.agilent.com/find/psa.

From this comparison, we can conclude that the PSA Series has much less amplitude uncertainty than the 8563E spectrum analyzer. This is also true when comparing the PSA Series with other spectrum analyzers in the market. Some of the uncertainties in traditional spectrum analyzers can be limited or minimized, such as by measuring the signal level with respect to the calibrated reference level and CRT scale without changing the reference level or attenuator controls. Such procedures can eliminate some of the uncertainties, but the remaining uncertainties are still much larger than the total uncertainty in the PSA Series. Because the PSA Series does not have many traditional amplitude uncertainties, it provides greater user flexibility in accurate amplitude measurements.

Table 2.

Specifications	PSA E4440A	8563E
Absolute frequency response 0 to 3 GHz	< ±0.4 dB	< ±1.8 dB
Log fidelity -20 dBm or lower Range of log fidelity	< ±0.07 dB unlimited reference level	< ±0.85 dB 100 dB from reference level
IF gain uncertainty	none	< ±1.0 dB
RBW switching (all but the widest)	< ±0.03 dB	< ±0.5 dB
Calibrator	Not specified	< ±0.3 dB
Calibrator + log + IF gain + RBW switching	< ±0.24 dB	Not specified, adds to 2.65 dB

Examples of the Measurement Uncertainties in Typical Amplitude Measurements

This section examines some typical amplitude measurements using both the PSA Series and the 8563E, with some suggestions on how to use the PSA Series to obtain the best amplitude accurate measurements.

We will list which uncertainties apply and calculate the total error and root sum of squares (RSS) error in Examples 1-4.

Example 1.

Signal power measurement (absolute measurement)

Measurement	Measure a 900 MHz CW signal at -5 dBm, using the 10 kHz RBW.			
Important tip	<p>In the PSA Series, the error caused by switching the attenuator from the reference setting of 10 dB is smaller than the log fidelity errors due to having an input signal to the first mixer above -20 dBm.</p> <p>On the PSA Series it is not necessary to move the signal to the reference line to improve accuracy. As long as the input attenuator is set so that the mixer level is at or below -10 dBm, the reference level can be set anywhere within the instrument's allowed range.</p>			
	PSA E4440A		Agilent 8563E	
Factor	Specified uncertainty (±dB)	Applicable uncertainty (±dB)	Specified uncertainty (±dB)	Applicable uncertainty (±dB)
Calibrator			0.3	0.3
Reference level	0.27	0.27	1.0	0.0 (if calibrated/used with 0 dBm reference level)
Scale fidelity			0.5	0.5
RBW switching				0.0 (if calibrated in 10 kHz RBW)
Frequency response ¹	0.38	0.38	1.5	1.5
Total uncertainty		0.67		2.3
Total uncertainty in RSS²		0.48		1.61

1 With 10 dB input attenuation.

2 Determining the total uncertainty for a measurement by adding all error contributors is a very conservative approach. A more realistic method of combining uncertainties is the root-sum-of-the-squares (RSS) method. In an amplitude measurement, the RSS uncertainty is based on the fact that most of the errors are independent of each other. Because they are independent, it is reasonable to combine the individual uncertainties in an RSS manner.

Finding the RSS uncertainty requires that each individual uncertainty is expressed in the same units. Typically uncertainties are expressed in terms of decibels.

$$RSS = [e_1^2 + e_2^2 + e_3^2 + \dots]^{1/2}$$

Where RSS, e_1 , e_2 , e_3 ... in dB.

Examples of the Measurement Uncertainties in Typical Amplitude Measurements (continued)

Example 2.

Relative measurement (using the delta marker) of signals in different bands

Measurement	10 GHz fundamental signal with its second harmonic at 20 GHz.
Important tip	In general, it is best to use the same input attenuator setting and resolution bandwidth setting for both signals. In this way, the uncertainties associated with input attenuation switching uncertainty and resolution bandwidth switching uncertainty will not affect the measurement.

Factor	PSA E4440A		Agilent 8563E	
	Specified uncertainty (±dB)	Applicable uncertainty (±dB)	Specified uncertainty (±dB)	Applicable uncertainty (±dB)
Frequency response (at 10 GHz)	1.0 dB (absolute)	1.0 dB	2.5 dB (relative) ¹	2.5 dB
Frequency response (at 20 GHz)	2.3 dB (absolute)	2.3 dB	3.0 dB (relative) ¹	3.0 dB
Band switching	N/A	0	1.0 dB ¹	1.0 dB
Log fidelity	0.07 ²	0.07	0.85 dB max (over 90 dB range)	0.85 dB max
Total uncertainty		3.37		6.55 dB
Total uncertainty in RSS		2.51		4.12 dB

1 The frequency responses relative to the absolute calibrator could be used, in which case band switching would not apply.
 2 Set the attenuator so that the signal level is below -20 dBm at the mixer.

Examples of the Measurement Uncertainties in Typical Amplitude Measurements (continued)

Example 3.

Third-order distortion measurement (relative measurement)

Measurement	Measure two 2 GHz signals separated by 50 kHz with third-order distortion at -80 dBc.
Important tip	For best distortion products from the PSA Series, the input signal level to the first mixer should be: $1/3 \times (2 \times \text{T0I} + \text{DANL})$. Please refer to PSA Series technical specifications. Figure 2 on page 6 shows that, for signals that are very close to the same frequency, frequency response can be ignored.

Factor	PSA E4440A		Agilent 8563E	
	Specified uncertainty (±dB)	Applicable uncertainty (±dB)	Specified uncertainty (±dB)	Applicable uncertainty (±dB)
Log fidelity	0.07 ¹	0.07	0.85 dB max (over 90 dB range)	0.85 dB max
Total uncertainty		0.07		0.85 dB
Total uncertainty in RSS		0.07		0.85 dB

1 Set the attenuator so that the signal level is below -20 dBm at the mixer.

Examples of the Measurement Uncertainties in Typical Amplitude Measurements (continued)

Example 4.

Mismatch measurement error and measurement uncertainty

Measurement	Measure a signal using the PSA E4440A at different input attenuation settings.
Important tip	<p>For all spectrum analyzers, some input attenuation is needed (to optimize impedance match) for the most accurate amplitude measurements.</p> <p>Mismatch errors are due to the impedance difference in source output and load input impedances. In a spectrum analyzer measurement, imperfections in the output impedance of the device under test (DUT) and the input impedance of the spectrum analyzer can both cause a mismatch error.</p> <p>The complete power transfer equation is:</p> $P_L/P_S = (1 - \rho_S^2)(1 - \rho_L^2) / (1 \pm \rho_L \rho_S)^2 \quad <1>$ $10 \log (P_L/P_S) = 10 \log (1 - \rho_S^2) + 10 \log (1 - \rho_L^2) - 20 \log (1 \pm \rho_S \rho_L) \quad <2>$ <p>In equation <2>, the first two terms determine the expected loss in power due to the reflection coefficient. The third term is the mismatch uncertainty. The actual power transfer can fall anywhere in between the two extremes represented by the + and – cases in the third term.</p> <p>The following two tables list the calculated result for a DUT with a voltage standing wave ratio (VSWR) 1.4:1, using the PSA Series to measure this device under different input attenuator settings.</p>

	VSWR < 10 dB input attenuation	ρ	VSWR ≥ 10 dB input attenuation	ρ
DUT output port	1.4:1	0.167	1.4:1	0.167
PSA 50 MHz – 3 GHz (from spec.)	2.3:1	0.394	1.2:1	0.091
Input attenuator setting	< 10 dB input attenuation		≥ 10 dB input attenuation	
Measurement error (dB)	–0.855		–0.159	
Measurement uncertainty (±dB)	–0.591/+0.553		–0.133/+0.131	
Total error range (dB)	–0.264/–1.408		–0.026/–0.29	

Mismatch error and uncertainty apply to all instruments used for amplitude measurement, such as power meters and spectrum analyzers.

Summary

New technology in the PSA Series high-performance spectrum analyzer has dramatically improved the amplitude accuracy of many signal measurements. Most traditional amplitude accuracy errors have been eliminated or reduced, while ease-of-use and measurement flexibility have both been improved.

References

- [1] *Spectrum Analysis Basics*, Application Note 150, literature number 5952-0292
- [2] *Optimizing Spectrum Analyzer Amplitude Accuracy*, Application Note 1316, literature number 5968-3659E
- [3] *Spectrum Analyzer Measurements and Noise*, Application Note 1303, literature number 5966-4008E
- [4] PSA E4440A Specifications. See page 21.

Glossary of Terms

ACP Adjacent Channel Power
ADC Analog to Digital Converter
ASIC Application Specific Integrated Circuit
CW Center Frequency
DANL Displayed Average Noise Level
DSP Digital Signal Process
dBc Decibels Relative to the Carrier Level
DUT Device Under Test
FFT Fast Fourier Transform
IF Intermediate Frequency
LO Local Oscillator
LSB Least Significant Bit
MSB Most Significant Bit
NIST National Institute of Standards and Technology
P1dB One dB Compression Point
RBW Resolution Bandwidth
RF Radio Frequency
RSS Root Sum of Squares
SR Sweep Rate
TOI Third Order Intercept
VBW Video Bandwidth
VSWR Voltage Standing Wave Ratio
YIG Yttrium Iron Garnet
YTF YIG Tuned Filter

Specifications

PSA E4440A Specifications

Frequency coverage	3 Hz to 50 GHz
DANL	-165 dBm (10 MHz to 3 GHz)
Absolute accuracy	±0.24 dB (50 MHz)
Frequency response	±0.38 dB (3 Hz to 3 GHz)
Display scale fidelity	±0.07 dB total (below -20 dBm)
TOI (mixer level -30 dBm)	+16 dBm (400 MHz to 2 GHz) +17 dBm (2-2.7 GHz) +16 dBm (2.7-3 GHz)
Noise sidebands (10 kHz offset)	-116 dBc/Hz (CF = 1 GHz)
1 dB gain compression	+3 dBm (200 MHz to 6.6 GHz)
Attenuator	0-70 dB in 2 dB steps

Warranty

The E4440A is supplied with a one year warranty.

Related Literature

Publication Title	Publication Type	Publication Number
<i>Agilent PSA Series High-Performance Spectrum Analyzers</i>	Brochure	5980-1283E
<i>Agilent PSA Series Spectrum Analyzers</i>	Data Sheet	5980-1284E
<i>Optimizing Dynamic Range for Distortion Measurements</i>	Product Note	5980-3079EN
<i>Measurement Innovations and Benefits</i>	Product Note	5980-3082EN
<i>Select the Right PSA Spectrum Analyzer for Your Needs</i>	Selection Guide	5968-3413E
<i>Self-Guided Demonstration</i>	Product Note	5988-0735EN
<i>Swept and FFT Analysis</i>	Product Note	5980-3081EN

Product Web site

For the most up-to-date and complete application and product information, please visit our product Web site at:
www.agilent.com/find/psa

Agilent Technologies' Test and Measurement Support, Services, and Assistance

Agilent Technologies aims to maximize the value you receive, while minimizing your risk and problems. We strive to ensure that you get the test and measurement capabilities you paid for and obtain the support you need. Our extensive support resources and services can help you choose the right Agilent products for your applications and apply them successfully. Every instrument and system we sell has a global warranty. Two concepts underlie Agilent's overall support policy: "Our Promise" and "Your Advantage."

Our Promise

Our Promise means your Agilent test and measurement equipment will meet its advertised performance and functionality. When you are choosing new equipment, we will help you with product information, including realistic performance specifications and practical recommendations from experienced test engineers. When you receive your new Agilent equipment, we can help verify that it works properly and help with initial product operation.

Your Advantage

Your Advantage means that Agilent offers a wide range of additional expert test and measurement services, which you can purchase according to your unique technical and business needs. Solve problems efficiently and gain a competitive edge by contracting with us for calibration, extra-cost upgrades, out-of-warranty repairs, and on-site education and training, as well as design, system integration, project management, and other professional engineering services. Experienced Agilent engineers and technicians worldwide can help you maximize your productivity, optimize the return on investment of your Agilent instruments and systems, and obtain dependable measurement accuracy for the life of those products.

Agilent Open

www.agilent.com/find/open

Agilent Open simplifies the process of connecting and programming test systems to help engineers design, validate and manufacture electronic products. Agilent offers open connectivity for a broad range of system-ready instruments, open industry software, PC-standard I/O and global support, which are combined to more easily integrate test system development.

Agilent Email Updates

www.agilent.com/find/emailupdates

Get the latest information on the products and applications you select.

Agilent Direct

www.agilent.com/find/agilentdirect

Quickly choose and use your test equipment solutions with confidence.

For more information on Agilent Technologies' products, applications or services, please contact your local Agilent office. The complete list is available at:

www.agilent.com/find/contactus

Phone or Fax

United States:

(tel) 800 829 4444
(fax) 800 829 4433

Canada:

(tel) 877 894 4414
(fax) 800 746 4866

China:

(tel) 800 810 0189
(fax) 800 820 2816

Europe:

(tel) 31 20 547 2111

Japan:

(tel) (81) 426 56 7832
(fax) (81) 426 56 7840

Korea:

(tel) (080) 769 0800
(fax) (080) 769 0900

Latin America:

(tel) (305) 269 7500

Taiwan:

(tel) 0800 047 866
(fax) 0800 286 331

Other Asia Pacific Countries:

(tel) (65) 6375 8100
(fax) (65) 6755 0042

Email: tm_ap@agilent.com

Contacts revised: 05/27/05

Product specifications and descriptions in this document subject to change without notice.

© Agilent Technologies, Inc. 2006

Printed in USA, August 31, 2006

5980-3080EN