



Agilent Option 1DN/1DQ

Scalar Measurements with the ESA-L1500A 1.5 GHz Spectrum Analyzer and Tracking Generator

Product Note



Agilent Technologies

Innovating the HP Way

Table of Contents

2 Overview

- 3 Comparing Test Equipment
- 4 Introduction to Tracking Generators

5 Transmission Measurements

- 5 What is a Transmission Measurement?
- 6 Making a Transmission Measurement with the Agilent ESA-L1500A
- 9 Measurement Uncertainty

11 Reflection Measurements

- 11 What is a Reflection Measurement?
- 12 Making a Reflection Measurement with the Agilent ESA-L1500A
- 15 Measurement Uncertainty

17 Special Measurements

- 17 Power Sweep Measurements
- 17 Frequency Translation Devices

18 Summary

19 Related Literature

19 Warranty Information

19 Related Specifications

Overview

Adding a tracking generator to the Agilent Technologies ESA-L1500A provides single-channel scalar-network-analysis capabilities in addition to its spectrum-analysis capabilities. The scalar-network-analysis capability allows you to perform stimulus-response measurements such as gain, frequency response, return loss, insertion loss, and flatness on components and subsystems.

Stimulus-response measurements are made to characterize the transmission or reflection parameters of a device. Devices can range from individual cables and components like filters and amplifiers, all the way to complex systems encompassing multiple components, connectors and cables. Some examples of stimulus-response measurements are: the 3 dB bandwidth of a bandpass filter, the return loss of an antenna, gain versus frequency for an amplifier, and the frequency-response of a length of cable. Stimulus-response measurements require a source to stimulate the device and a receiver to analyze its frequency-response characteristics.

The purpose of this product note is to show how to make accurate stimulus-response measurements using the ESA-L1500A spectrum analyzer with the optional tracking generator (Option 1DN/1DQ).

We will also discuss the correct measurement technique for various frequency-response measurement applications.

The major topics we shall discuss are as follows:

- 1. Transmission Measurements**—What is a transmission measurement and how to make an accurate measurement using the ESA-L1500A with Opt 1DN/1DQ.
- 2. Reflection Measurements**—What is a reflection measurement and how to make an accurate measurement using the ESA-L1500A with Opt 1DN/1DQ.
- 3. Special Transmission/Reflection Measurements**—How to make power sweep and frequency offset stimulus-response measurements.

Before we begin, there are many questions concerning measurement parameters that need to be answered. Does the spectrum analyzer/tracking generator cover the required frequency range with enough power to test the device? Does the spectrum analyzer have the required dynamic range? Is it sensitive enough to detect low level signals? Will source harmonics effect the measurement? Are the measurement results accurate enough to meet the specifications? Can the required measurement be made in a timely fashion? Answers to these questions will be unique for each measurement and can be found in the product literature/datasheet.

Comparing Test Equipment

The two major instruments capable of making frequency-response measurements are network analyzers and spectrum analyzers. There are two types of network analyzers, vector and scalar. If phase information is required, a vector network analyzer will be needed. Vector network analyzers also make the most accurate frequency-response measurements by utilizing vector-error correction. A swept-tuned spectrum analyzer, however, is a scalar instrument; therefore, we will focus our discussions on scalar stimulus-response measurements.

Scalar network analyzers differ from spectrum analyzers with tracking generator in many ways. Features offered by some scalar network analyzers include the following:

1. Multiple input ports for making simultaneous transmission and reflection measurements without having to reconfigure or recalibrate the measurement setup.
2. Selectable detectors that allow the user to choose the detector characteristics that best suit the application.
3. Flexible display formats, selectable from the front panel and calculated inside the scalar network analyzer to allow visual analysis of measured transmission and reflection parameters.
4. More advanced error correction.

A spectrum analyzer, on the other hand, offers some attractive features. Most important is its dual use; in addition to measuring signal amplitude characteristics such as carrier level, sidebands, harmonics, etc., a spectrum analyzer with tracking generator can also make scalar component tests with high dynamic range (due to the spectrum analyzer's tuned receiver architecture and narrow IF bandwidths).

Introduction to Tracking Generators

A tracking generator is a signal source whose RF output follows (tracks) the tuning of the spectrum analyzer. The tracking generator output signal is generated by mixing the signals from two or more oscillators. A simplified block diagram is shown in Figure 1.

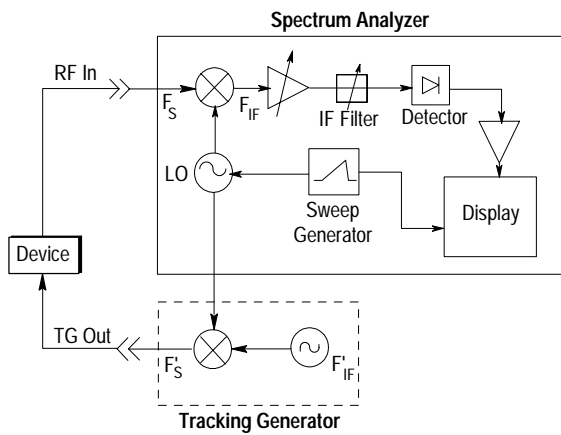

Figure 1: Spectrum Analyzer with Tracking Generator

For the spectrum analyzer block diagram, the incoming signal, F_s , mixes with the LO, and when the mixing product equals the center frequency of the IF filter, this signal passes through to the peak detector. The detector output is amplified to cause a vertical deflection on the display. Synchronism between the horizontal frequency axis of the display and the tuning of the LO is provided by the sweep generator, which both drives the horizontal deflection and tunes the LO.

The tracking generator uses the swept LO from the spectrum analyzer and mixes that LO signal with a stable, fixed oscillator. If we tune the oscillator in the tracking generator (F'_{if}) to the center frequency of the IF filter in the spectrum analyzer, F_{if} , and use the difference mixing product, then the output frequency of the tracking generator (F'_s) will equal the input frequency of the spectrum analyzer (F_s).

$$F_s = F_{LO} - F_{IF} \quad \text{and} \quad F'_s = F_{LO} - F'_{IF}$$

The spans of the spectrum analyzer and tracking generator are matched and synchronous, and therefore precise tracking between the two instruments is achieved.

When making measurements, the dynamic range and frequency accuracy can degrade somewhat when using a tracking generator, mainly due to tracking error and residual FM. Tracking error occurs when the tracking generator's output frequency is not exactly matched to the input frequency of the spectrum analyzer. The resulting mixing product from the spectrum analyzer's input mixer is not at the center of the IF bandwidth. This shift in frequency can, in narrow resolution bandwidth filters, cause the tracking signal to fall on the skirt rather than the center of the IF filter, resulting in a degradation in dynamic range. The Agilent ESA-L1500A is fully synthesized and therefore has no tracking error. Residual FM is caused by the instability of the LO, and can cause degradation in frequency accuracy of narrowband devices. The specification for the ESA-L1500A is ≤ 100 Hz peak-to-peak.

Transmission Measurements

What is a Transmission Measurement?

A scalar transmission measurement determines the gain or loss of a device. Let's define some transmission terms that will be helpful when talking about transmission measurements.

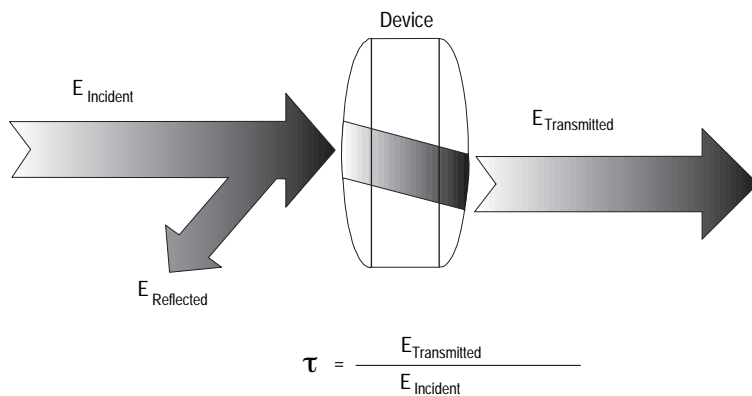

$$\begin{aligned} \text{Transmission Coefficient (dB)} &= 20 \log \tau \text{ (gain)} \\ &= -20 \log \tau \text{ (loss)} \end{aligned}$$

Figure 2: Transmission Measurements

The transmission coefficient, τ , is equal to the transmitted voltage, $E_{\text{Transmitted}}$, divided by the incident voltage, E_{Incident} . Since many displays are logarithmic, we need to express the transmission coefficient in dB.

$$\begin{aligned} &20 \log [\tau] \\ &\text{or} \\ &20 \log [E_{\text{Transmitted}}] - 20 \log [E_{\text{Incident}}] \end{aligned}$$

This coefficient can be applied to all our transmission measurements. Attenuation, insertion loss, and gain measurements can be expressed as follows:

$$\text{Attenuation (dB) or Insertion loss (dB)} \\ = P_{\text{Incident}} \text{ (dBm)} - P_{\text{Transmitted}} \text{ (dBm)}$$

$$\text{Gain (dB)} = P_{\text{Transmitted}} \text{ (dBm)} - P_{\text{Incident}} \text{ (dBm)}$$

Making a Transmission Measurement with the Agilent ESA-L1500A

The first thing we need to do before making a transmission measurement is to configure the spectrum analyzer/tracking generator system. As shown in Figure 3, the RF output from the tracking generator is connected to the input of the device, and the output of the device is connected to the input of the ESA-L1500A. Next, we need to turn the tracking generator on by going into the [Source Amptd] hardkey functions, and turning the Amplitude On; {Amplitude On Off}.

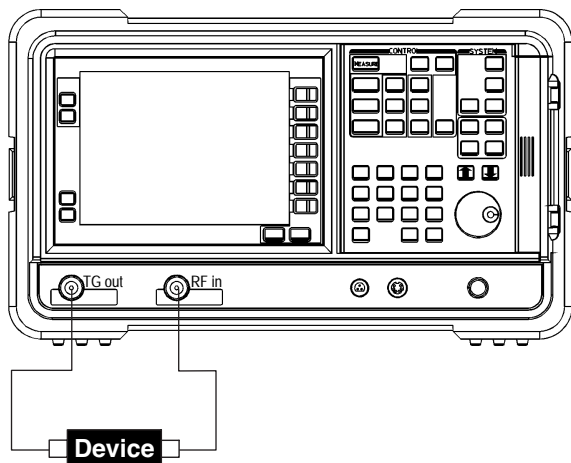

Figure 3: Transmission Measurement Set-Up

An overview of the steps required to make an accurate transmission measurement are as follows:

- A. Set up the spectrum analyzer's control settings (frequency, resolution bandwidth, sweep time, input attenuation, etc.) with the device connected.
- B. Establish a 0 dB reference by removing the device and measuring the incident signal level. Turn on the normalization function to subtract the incident power from the transmitted power.
- C. Make the transmission measurement by re-inserting the device into the transmission measurement path.

Next, we visit each of these steps in detail using an actual measurement as an example:

Step A. In this transmission measurement, we are going to use a bandpass filter (BPF) as our test device. With the BPF in the measurement path, the spectrum analyzer's control settings need to be adjusted for the specific type of measurement to be made. For example, if we need to make a passband-ripple measurement on our BPF (see Figure 4a), the spectrum analyzer requires a narrow span and typically <10 dB per vertical division to get more resolution on the display. If, on the other hand, we need to make a stop-band attenuation measurement on our BPF (Figure 4b), the spectrum analyzer requires a wide span and a narrow RBW filter. This reduces the noise floor of the spectrum analyzer to give a wider dynamic range. The point is to set up the analyzer with the device in the measurement path in order to get a trace on the display representative of the required measurement. Once the spectrum analyzer's control settings have been adjusted, they should not be changed during the course of the measurement. Control settings are those which effect the spectrum analyzer's hardware, such as input attenuator, reference level, resolution bandwidth, span, etc. If any control settings are changed, inaccuracies could be introduced into our measurement system that might not otherwise be present.

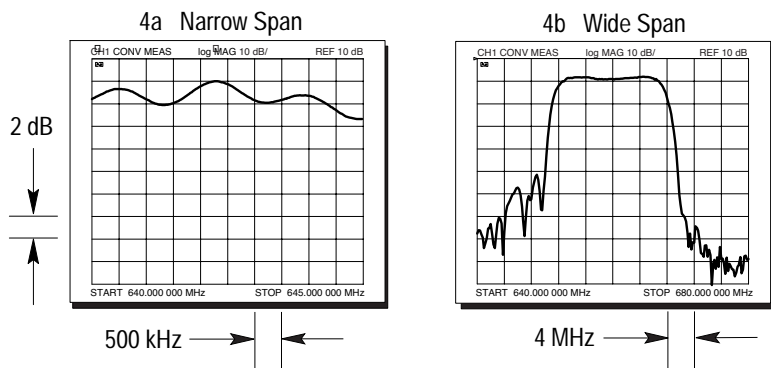

Figure 4: Set-Up for Various Measurements

A faster sweep can be achieved by changing the coupling from normal spectrum analyzer mode to stimulus response mode.¹ Press [Sweep], {Swp Coupling SR SA} until SR is underlined. It is important to note, however, that the limitation on sweep speed is typically determined by the device. Care must be taken to allow the device sufficient time to respond to the signal being passed through it. If the auto stimulus-response-mode sweep is too fast, slow it down until no changes in amplitude occur on the trace.

1. Stimulus response mode uses a faster set of sweep time equations. Since the IF signal is always centered, the IF bandwidth filters don't need to charge and discharge.

Step B. Before we can determine the transmission loss or gain of our device, we must measure the incident signal level. We do this by removing the device and measuring a “thru” from the source directly to the receiver. This establishes a 0 dB reference trace which is stored in the spectrum analyzer and used for normalizing the measured data. The procedure on the Agilent ESA-L1500A is as follows:

1. Remove device and connect the tracking generator output directly to the spectrum analyzer input using the same test cables as will be used in the measurement. Use a thru adapter if necessary to connect the test cables.
2. Notice that the frequency response may not be perfectly flat, showing the response of the cables, as well as the flatness of both the tracking generator and the spectrum analyzer.
3. Turn Normalize On: [Trace], {Normalize >}, {Normalize On}. This procedure automatically subtracts the measured “thru” level from an ideal thru (flat reference line) and stores it. This difference is then used to normalize the measured signal (measured signal - error = normalized signal).
4. Notice that with the device disconnected, the displayed trace is now flat, or normalized. The position of the normalized trace can be moved to a different position on the display by changing the normalized reference position {Norm Ref Posn}. This may be useful if the device to be tested has positive gain, such as an amplifier.

Step C. We are now ready to re-insert the device and make the transmission measurement. As the output of the tracking generator sweeps across the BPF, we see the frequency response of the filter on the display of the analyzer. Normalization has enabled us to make a relative measurement and remove the frequency-response errors of the test setup.

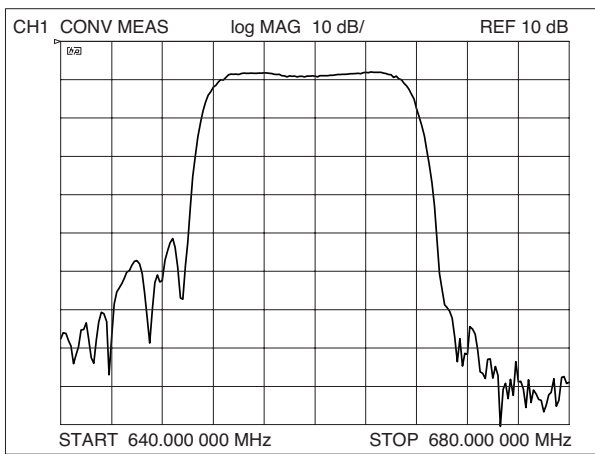

Figure 5: Transmission Measurement

Measurement Uncertainty

Now that we have made the transmission measurement, we need to determine how accurate our measurement is.

The measurement uncertainty associated with the transmission measurement is comprised of three terms: frequency response, display fidelity, and mismatch uncertainty. We have already determined that frequency-response errors are eliminated through normalization. Display-fidelity errors are a function of the spectrum analyzer's ability to accurately display the amplitude of a signal at any point on the display. Care must be taken to select a spectrum analyzer with display fidelity specifications that meet the accuracy requirements of the measurement. The ESA-L1500A display scale fidelity is the smaller of: $\pm 0.4 \text{ dB}/4 \text{ dB}$ and $[0.3 \text{ dB} + 0.01 \times \text{dB from reference level}]$. For example, if the signal level to be measured is 5 dB from the reference level, the measurement inaccuracy would be the smaller of: $(\frac{0.4}{4} \text{ dB})(5 \text{ dB}) = \pm 0.5 \text{ dB}$ and $[0.3 \text{ dB} + (0.1)(5 \text{ dB})] = \pm 0.35 \text{ dB}$. Therefore, the uncertainty is $\pm 0.35 \text{ dB}$.

Mismatch uncertainty errors can be minimized with a proper understanding of how they are created. Mismatch uncertainties can be broken into two categories: (1) uncertainties associated with the calibration stage of the measurement and (2) uncertainties associated with the measurement stage of the measurement (see Figure 6).

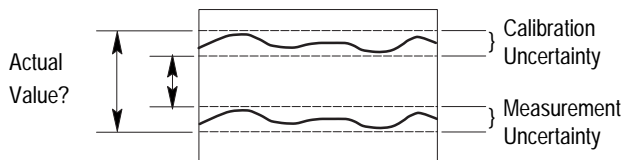

	Cause	Solution
Calibration Uncertainty	Mismatch of Source/Receiver	Improve match by isolation
Measurement Uncertainty	Mismatch of Source/Device Device/Receiver	

Figure 6: Measurement Uncertainties

Calibration uncertainties are due to the impedance mismatch between the tracking generator and spectrum analyzer. A portion of the incident signal is reflected back towards the source because of the spectrum analyzer's input impedance mismatch. This reflected signal is then re-reflected by the tracking generator impedance mismatch, resulting in an uncertainty vector related to the incident signal at some unknown phase. This uncertainty vector can add or subtract from the actual measured amplitude, causing an error in the calibration (thru) measurement.

Similarly, amplitude uncertainties during the measurement of the device are caused by the source/device input impedance mismatch and device output/receiver impedance mismatch. Because the actual value of our device is the difference between the calibration value and the measured value, and each measurement (calibration and measurement) has an associated tolerance, it is difficult for us to determine the actual value of our measurement.

To help minimize the calibration and measurement uncertainties, we can improve the impedance match between units by isolating them from one another. Inserting attenuators into the measurement path will attenuate the reflected signal each time it flows through an attenuator, in turn minimizing the re-reflected signals and the uncertainty vectors.

To get a feel for the errors associated with mismatch uncertainty, let's calculate a typical mismatch uncertainty value.

To calculate the maximum mismatch error (MME), we must convert the Standing Wave Ratio (SWR) to a reflection coefficient, r (described in detail on page 12).

$$r = (\text{SWR} - 1)/(\text{SWR} + 1)$$

and use the reflection coefficient in the following equation:

$$\begin{aligned} \text{MME} &= \pm[\text{cal uncert} + \{\text{meas uncert}\}] \\ \text{MME (dB)} &= [20 \log (1 \pm r_1 r_2) + \{20 \log (1 \pm r_1 r_2)^2 + \\ &20 \log (1 \pm r_1 r_i) + 20 \log (1 \pm r_2 r_o)\}] \end{aligned}$$

where r_1 , r_2 , r_i , and r_o are the reflection coefficients associated with the SWR of the source, receiver, device input, and device output, respectively. For the ESA-L1500A, source output SWR is <2.5:1, and receiver RF input SWR is 1.55:1 (for 0 to 5 dB attenuation). We'll assume that the device SWR = 1.7 at both the input and output. We can calculate the reflection coefficients as follows:

$$\begin{aligned} r_1 &= (2.5 - 1)/(2.5 + 1) = 0.43 \\ r_2 &= (1.55 - 1)/(1.55 + 1) = 0.22 \\ r_i = r_o &= (1.7 - 1)/(1.7 + 1) = 0.26 \end{aligned}$$

Therefore, the maximum mismatch error for our test is:

$$\begin{aligned} \text{MME} &= 20 \log [1 \pm (0.43)(0.22)] + \{20 \log [1 \pm (0.43)(0.22)] + 20 \log \\ &[1 \pm (0.43)(0.26)] + 20 \log [1 \pm (0.22)(0.26)] \\ &= (0.79 + 0.79 + 0.92 + 0.48), (-0.86 - 0.86 - 1.03 - 0.51) \\ &= +2.97 \text{ dB}, -3.27 \text{ dB} \end{aligned}$$

2. For low-loss bidirectional devices, this term is also part of {meas uncert} and therefore occurs twice.

We can improve this significantly with the use of attenuators. As long as dynamic range can be sacrificed due to the losses in the attenuators, a system with well matched pads or attenuators can make excellent transmission measurements.

For example, if we insert 10 dB attenuators with SWR = 1.1:1 at the input and output of our device, our calculation now becomes:

$$r'_1 = 0.43 * (0.32)^2 + 0.48 = 0.092$$

$$r'_2 = 0.22 * (0.32)^2 + 0.48 = 0.071$$

The new reflection coefficients for source and load now take into account the SWR of the pads (1.1 converted to linear = 0.48) and the fact that the pads reduce the reflection coefficients by twice the attenuator value (10 dB converted to linear = 0.32). Using these values in the MME equation above, we get much improved uncertainty values:

$$\begin{aligned} \text{MME} &= 20 \log [1 \pm (0.092)(0.071)] + \{20 \log [1 \pm (0.092)(0.071)] \\ &\quad + 20 \log [1 \pm (0.092)(0.26)] + 20 \log [1 \pm (0.071)(0.26)]\} \\ &= (0.06 + 0.06 + 0.20 + 0.16), (-0.06 - 0.06 - 0.21 - 0.16) \\ &= +0.48 \text{ dB}, -0.49 \text{ dB} \end{aligned}$$

In summary, to make an accurate transmission measurement using the ESA-L1500A spectrum analyzer, perform the following steps:

1. Analyze the system configuration and improve the effective impedance match between the source/receiver, source/device, and device/receiver using attenuators.
2. Set the control settings of the spectrum analyzer for the particular measurement that needs to be made. Do not change the settings.
3. Perform a “thru” measurement to establish a 0 dB reference and set up the normalization function.
4. Make the measurement by re-inserting the device.
5. Read the spectrum analyzer’s display for the transmission measurement information.

Reflection Measurements

What is a Reflection Measurement?

A scalar reflection measurement is concerned with how efficiently energy is transferred into a device and reveals the degree of mismatch between a device and a Z_0 transmission line (Z_0 = characteristic impedance, typically 50 Ω). Seldom is all the energy incident upon a device absorbed by the device, and that portion not absorbed is reflected back toward the source. We can determine the efficiency of energy transfer by comparing the incident and reflected signals. Let’s define some terms about reflection that will be helpful when discussing reflection measurements.

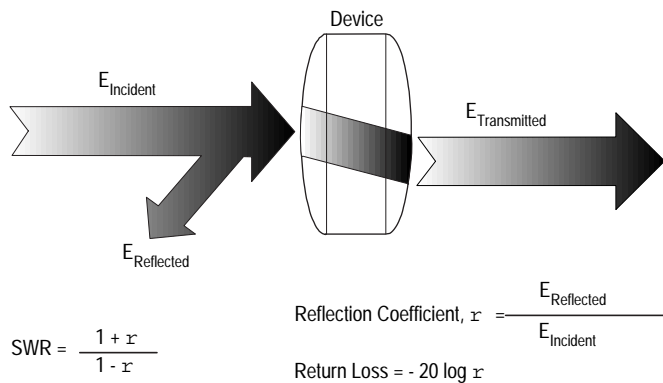

Figure 7: Reflection Measurements

The reflection coefficient, r , is equal to the reflected voltage, $E_{\text{Reflected}}$, divided by the incident voltage, E_{Incident} . For a transmission line terminated in a perfectly matched load, all the energy is transferred to the load and none is reflected: $E_{\text{Reflected}} = 0$ and $r = 0$. When the same transmission line is terminated with an open or short circuit, all the energy is reflected back: $E_{\text{Reflected}} = E_{\text{Incident}}$ and $r = 1$. Therefore, the possible values for r are from 0 to 1.

Since many displays are logarithmic, we need a term to express the reflection coefficient in dB. Return loss can be thought of as the number of dB that the reflected signal is below the incident signal and is equal to $-20 \log r$. The range of values for return loss are infinity (for a matched load) to 0 (for an open or short circuit).

The third term that needs definition is standing-wave ratio (SWR). Standing waves are caused by the interaction of the incident and reflected waves along a line. The SWR equals the maximum envelope voltage of the combined traveling waves over the minimum envelope voltage. SWR can also be expressed in terms of the reflection coefficient $(1 + r)/(1 - r)$ and ranges from 1 (perfect match) to infinity (open or short).

Making a Reflection Measurement with the Agilent ESA-L1500A

As with transmission measurements, the first thing we need to do before making a reflection measurement is to configure the spectrum analyzer/tracking generator system. For a reflection measurement, we need the addition of a signal separation device such as a directional coupler or bridge (see Figure 8). Again, we need to turn the tracking generator on by going into the [Source Amptd] hardkey functions, and turning the Amplitude On; {Amplitude On Off}. For faster sweeps, change the coupling from normal spectrum analyzer mode to stimulus response mode: Press [Sweep], {Swp Coupling SR SA} until SR is underlined.

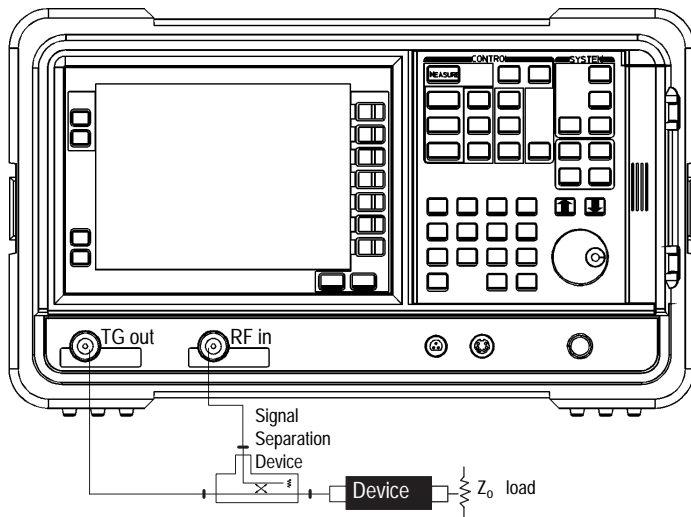

Figure 8: Reflection Measurement Set-Up

The steps required to make an accurate reflection measurement are as follows:

- A. Set up the spectrum analyzer's control settings (frequency, resolution bandwidth, sweep time, input attenuation, etc.) with the device connected.
- B. Establish a 0 dB return loss by connecting an open or short circuit and measuring the reflected signal level. Turn on the normalization function to subtract the calibration data from the measurement data.
- C. Make the reflection measurement by re-connecting the device.

Again, we visit each of these steps in detail using an actual measurement as an example:

Step A. In this reflection measurement, we are going to measure the return loss of a bandpass filter. With the filter connected, the spectrum analyzer's control settings need to be adjusted for the correct frequency coverage, resolution bandwidth, input attenuation, etc. Our objective is to get a trace on the display representative of the measurement required. Once the spectrum analyzer's control settings have been adjusted, they should not be changed during the course of a measurement. If any control settings are changed, inaccuracies could be introduced into our measurement system that might not otherwise be present.

Step B. Before the reflection measurement can be made, we must establish a reference line on the display with a known standard (we'll use a short). Since a short cannot dissipate the energy of the incident signal, a reflected wave is reflected back from the short (100% reflection). The coupler routes the reflected wave to the spectrum analyzer, where its value is displayed. The reflection coefficient of the short circuit is 1 ($E_{\text{Incident}} = E_{\text{Reflected}}$), which equates to a 0 dB return loss ($-20 \log 1$).

The procedure on the Agilent ESA-L1500A is as follows:

1. Remove device and connect a short in its place (see Figure 9).
2. Turn Normalization On: [Trace], {Normalize >}, {Normalize On}. This procedure establishes a 0 dB return loss and enables us to make a relative measurement by automatically subtracting the short circuit calibration from the measurement obtained with the device.

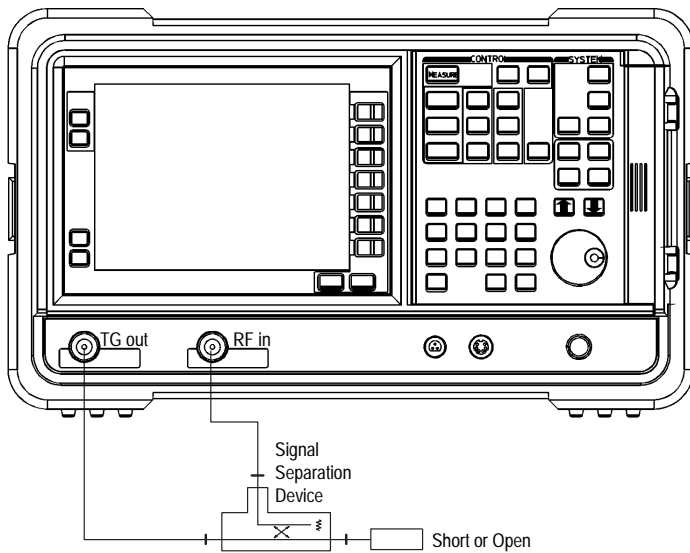

Figure 9: Calibrate the Analyzer

Step C. We are now ready to re-connect the device and make the reflection measurement. As the tracking generator sweeps across the frequency range of interest, the return loss of the device is displayed on the spectrum analyzer's screen.

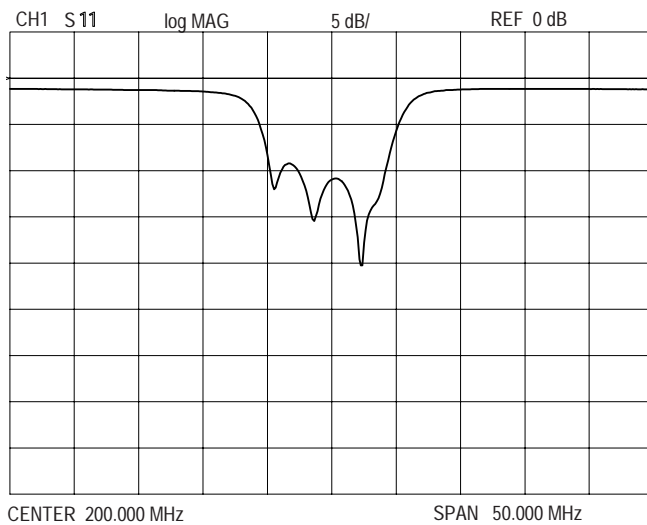

Figure 10: Reflection Measurement

Measurement Uncertainty

Now that we have made the reflection measurement, we need to determine how accurate the measurement is.

The measurement uncertainty associated with the reflection measurement is comprised of four terms:

$$D_r = A + Br + Cr^2 + D$$

This equation is a simplification of a complex flowgraph analysis. D_r is the worst case uncertainty in the measurement where r is the measured reflection coefficient of the device. A, B, C and D are all in linear terms. Each term in this equation will be analyzed separately:

A. Directivity—this is the measure of a bridge or directional coupler's ability to separate signals flowing in opposite directions. Since no signal separation device is perfect, some of the incident energy flowing in the main arm of the coupler leaks across to the auxiliary arm, causing an error in the signal level measured by the spectrum analyzer. This directivity signal is independent of the reflection coefficient and of the device under test and adds (in the worst case) directly in or out of phase with the reflection signal. The signal separation device selected is extremely important to the accuracy of the measurement. A recommended bridge is the Agilent Technologies 86205A which has directivity of 40 dB. We cannot remove the impact of directivity, so we must select a separation device with high enough directivity for our need, if we can.

B. Calibration Error—when calibrating the system with a standard (open or short) some error terms will also be measured. Directivity and source match are always present and will be measured. The sum of directivity and source match (A + C) will cause uncertainty in the measurement of the standard.³

C. Effective Source Match—a perfect source match would deliver a constant power to the load regardless of the reflection from the load. If the source match is not perfect, signals will be re-reflected, adding to the incident signal at some unknown phase, and causing an error in the measurement. Leveling and isolation can help improve source match. For isolation, it is recommended to use a 10 dB pad between the tracking generator and the bridge (or coupler) to reduce this source match.

D. Display Fidelity—these errors are a function of the spectrum analyzer's ability to accurately display the amplitude of a signal at any point on the display. The ESA-L1500A display scale fidelity is the smaller of: ± 0.4 dB/4 dB and $\pm(0.3$ dB + $0.01 \times$ dB from reference level).

3. A network analyzer can eliminate calibration error by using both an open and a short. Because these two standards will create equal responses but with opposite phases, they can be averaged, thus making $B = 0$. The ESA-L1500A with tracking generator does not have the ability to do open/short averaging and therefore calibration error equals the sum of directivity and source match.

The best way to reduce the measurement uncertainty is to use a signal separation device with good directivity (40 dB), and a 10 dB pad between the bridge and tracking generator output to improve source match. The Agilent ESA-L1500A has enough dynamic range that this additional loss will not effect most measurements.

To get a feel for the accuracy you can expect using the ESA-L1500A, we have calculated some typical values, making the following assumptions of coupler directivity, reflection coefficient of the device, source match, and display fidelity. We have also assumed the use of a 10 dB pad with SWR = 1.1 (see Figure 11).

Directivity = 40 dB
 Reflection coefficient of device, $r = 0.26$
 Source match = 0.43
 Display fidelity = smaller of ± 0.4 dB/4 dB and $\pm(0.3 + 0.01 \times \text{dB from ref})$

Using the uncertainty equation, and the appropriate values for A, B, C, D and r, we find:

A = Directivity = 40 dB = 0.01
 B = Calibration Error = (A + C) = 0.102
 C = Source Match with 10 dB pad⁴ = $r'_1 = 0.092$
 D = Display Fidelity⁵ = 0.42 dB = 0.05
 r = Ref. Coef. of Device = 0.26

$$\begin{aligned} Dr &= A + Br + Cr^2 + D \\ &= 0.01 + (0.102)(0.26) + (0.092)(0.26)^2 + 0.05 \\ &= 0.01 + 0.027 + 0.006 + 0.05 \\ &= \pm 0.093 \end{aligned}$$

Note for comparison that without the pad, C = 0.43 and B = 0.44, which results in a Dr = ± 0.21 .

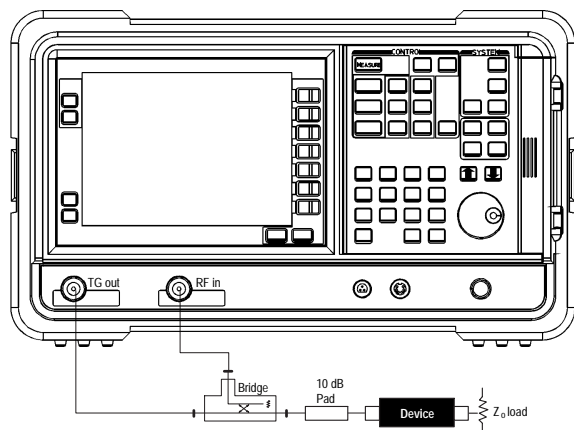

Figure 11: Pads Improve Measurement Uncertainty

4. See page 11 for calculation of source match that takes into account the SWR of the pad.
 5. The return loss of the device is 12 dB. With this as the dB from reference level, we find the smaller of the two display fidelity values to be $(0.3 + 0.01 \times 12)$ dB = 0.42 dB

In summary, to make an accurate reflection measurement using a spectrum analyzer, we perform the following steps:

1. Analyze the system configuration and improve the effective impedance match of the system using isolation pads.
2. Set the controls on the spectrum analyzer for the particular measurement to be made. Do not change these settings.
3. Perform a short or open normalization in order to establish a reference line on the display.
4. Make the measurement by re-connecting the device.
5. Read the spectrum analyzer's display for the reflection measurement information.

Special Measurements

Two special stimulus-response measurements are power sweep measurements and frequency translation devices such as TV tuners, mixers, etc.

Power Sweep Measurements

The ability to sweep the tracking generator's power makes the Agilent ESA-L1500A particularly useful in making gain compression measurements or output power versus frequency measurements. A power sweep can be made over time at a fixed frequency or in synchronization with the frequency sweep of the analyzer.

To do a power sweep at a fixed frequency, set the analyzer to the desired frequency and then put it into zero span: [Span], {Zero Span}.

To activate the power-sweep function, access the tracking generator's key functions: [Source Amptd], {Power Sweep On Off}. Set power sweep to On. The analyzer will continue to sweep a specified frequency range when power sweep is on, unless in zero span as mentioned above. The available power-sweep range (minimum power to maximum power) is a function of the source attenuator setting. See "Related Specifications" for the available power sweep range of the ESA-L1500A with tracking generator.

The output power of the tracking generator is swept according to the sweep rate of the spectrum analyzer. The output power is always swept from the source power setting to a higher power setting (negative source power sweep values are not allowed).

Frequency Translation Devices

Frequency-response measurements in which the source is offset in frequency from the receiver are possible using a signal generator as the source and the ESA-L1500A as the receiver. The source and receiver now operate asynchronously (unlike the spectrum analyzer/tracking generator combination). The configuration is shown in Figure 12.

1. Adjust the sweeping source and spectrum analyzer to cover the same frequency range.
2. Set the sweep time on the sweeping source to be slow in comparison to the sweep time of the spectrum analyzer.
3. Place the ESA-L1500A in Max Hold: [Trace], {Max Hold A or B}. This maintains the maximum level for each trace point of the selected trace (A or B) over time. After a number of sweeps, the frequency-response of the device is traced out on the display.

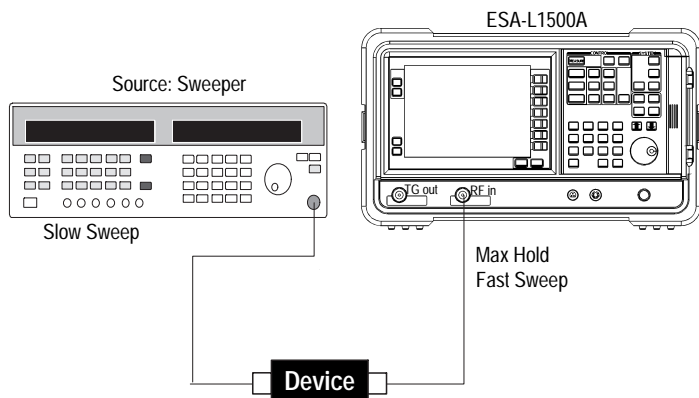

Figure 12: Frequency-Translation Devices

Summary

Adding a tracking generator to the Agilent ESA-L1500A gives you the ability to make accurate stimulus-response measurements in addition to general purpose spectrum analysis measurements. As a receiver, a spectrum analyzer offers large dynamic range and eliminates harmonics from the display. Tracking generators, as the companion source to a spectrum analyzer, allow simple transmission/reflection measurements.

Transmission measurements such as attenuation, insertion loss, and gain, and reflection measurements such as return loss and SWR can easily be made in three basic steps; 1) set up the spectrum analyzer's control settings, 2) perform a normalization function to establish a reference, and 3) make the measurement.

In addition to these standard stimulus-response measurements, the ESA-L1500A is capable of making a variety of special stimulus-response measurements. With the tracking generator and its power sweep function, it is a very useful tool for making gain compression or power versus frequency measurements. With the addition of an external signal generator (instead of the tracking generator), the ESA-L1500A can be used for making measurements on frequency translation devices.

Related Literature

Agilent ESA-L1500A 1.5 GHz Portable Spectrum Analyzer, Product Overview, P/N 5965-6309E

Warranty Information

Options 1DN (50-ohm output impedance) and 1DQ (75-ohm output impedance) tracking generators carry the same warranty as the ESA-L1500A Portable Spectrum Analyzer.

Related Specifications

Output Power Sweep

Range:

50 Ω (Option 1DN) (-15 dBm to 0 dBm) - (Source Attenuator Setting)
Resolution 0.1 dB
Accuracy (zero span) <1.5 dB peak-to-peak

Maximum Power Sweep Characteristics⁶

Manual Attenuator Setting	Allowed Source Amplitude (Start of Power Sweep Level)	Power Sweep Range
0 dB	-15 dBm to 0 dBm	0 to 15 dB
10 dB	-25 dBm to -10 dBm	0 to 15 dB
20 dB	-35 dBm to -20 dBm	0 to 15 dB
30 dB	-45 dBm to -30 dBm	0 to 15 dB
40 dB	-55 dBm to -40 dBm	0 to 15 dB
50 dB	-65 dBm to -50 dBm	0 to 15 dB
60 dB	-75 dBm to -60 dBm	0 to 15 dB

6. To get the Maximum power sweep range, press Attenuation Auto Man (in the Source Amptd menu) so that Man is underlined. This turns off the auto coupling so that you can set the attenuation manually.

Agilent Technologies' Test and Measurement Support, Services, and Assistance

Agilent Technologies aims to maximize the value you receive, while minimizing your risk and problems. We strive to ensure that you get the test and measurement capabilities you paid for and obtain the support you need. Our extensive support resources and services can help you choose the right Agilent products for your applications and apply them successfully. Every instrument and system we sell has a global warranty. Support is available for at least five years beyond the production life of the product. Two concepts underlie Agilent's overall support policy: "Our Promise" and "Your Advantage."

Our Promise

"Our Promise" means your Agilent test and measurement equipment will meet its advertised performance and functionality. When you are choosing new equipment, we will help you with product information, including realistic performance specifications and practical recommendations from experienced test engineers. When

you use Agilent equipment, we can verify that it works properly, help with product operation, and provide basic measurement assistance for the use of specified capabilities, at no extra cost upon request. Many self-help tools are available.

Your Advantage

"Your Advantage" means that Agilent offers a wide range of additional expert test and measurement services, which you can purchase according to your unique technical and business needs. Solve problems efficiently and gain a competitive edge by contracting with us for calibration, extra-cost upgrades, out-of-warranty repairs, and on-site education and training, as well as design, system integration, project management, and other professional services. Experienced Agilent engineers and technicians worldwide can help you maximize your productivity, optimize the return on investment of your Agilent instruments and systems, and obtain dependable measurement accuracy for the life of those products.

By internet, phone, or fax, get assistance with all your test and measurement needs.

Online Assistance

www.agilent.com/find/assist

Phone or Fax

United States:

(tel) 1 800 452 4844

Canada:

(tel) 1 877 894 4414

(fax) (905) 206 4120

Europe:

(tel) (31 20) 547 2323

(fax) (31 20) 547 2390

Japan:

(tel) (81) 426 56 7832

(fax) (81) 426 56 7840

Latin America:

(tel) (305) 269 7500

(fax) (305) 269 7599

Australia:

(tel) 1 800 629 485

(fax) (61 3) 9272 0749

New Zealand:

(tel) 0 800 738 378

(fax) (64 4) 495 8950

Asia Pacific:

(tel) (852) 3197 7777

(fax) (852) 2506 9284

Product specifications and descriptions in this document subject to change without notice.

Copyright © 1997, 2000 Agilent Technologies
Printed in U.S.A. 8/00
5966-1650E

**Agilent Technologies**

Innovating the HP Way