

Product Note/Specification Guide

HP 5371A Frequency and Time Interval Analyzer

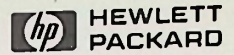

MTR

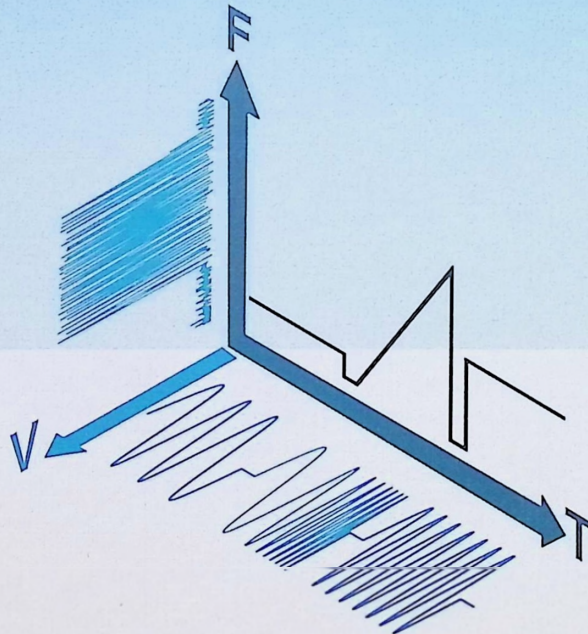
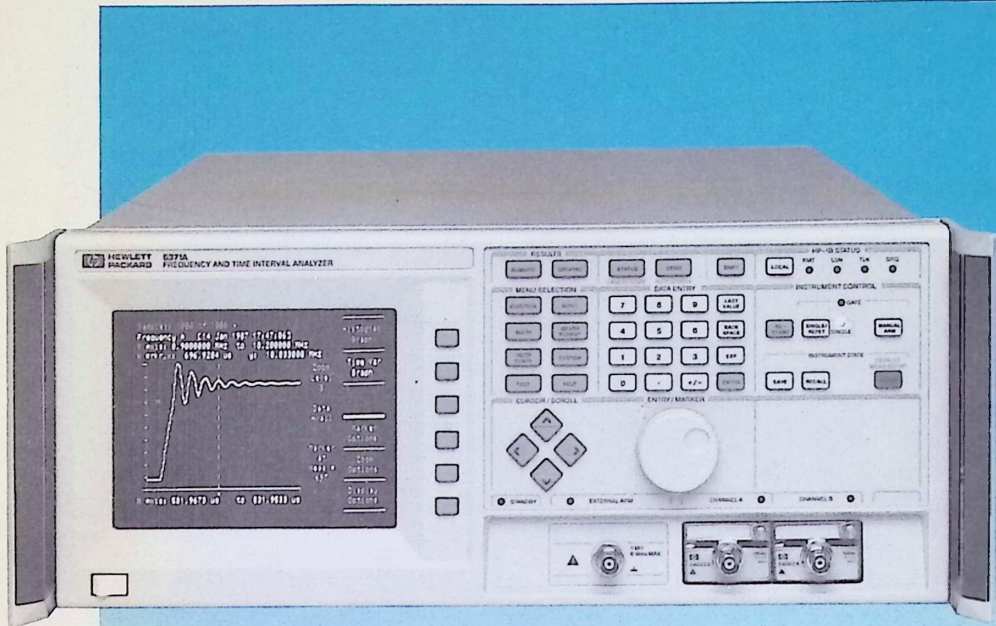

Purpose of this Product Note

This product note is divided into two sections. The first section is intended to provide a general understanding of how the HP 5371A makes its measurements and how the analysis functions work. The second section contains the detailed specifications of the HP 5371A. If further information is needed, please see the HP 5371A's Operating and Programming Manual.

Table of Contents

Page

I. Product Note

Continuous Measurement Concepts	1
Frequency Measurements vs. Time	
Frequency Sampling	
Time Interval Measurements vs. Time	
Time Sampling	
Continuous Measurement General Definitions	10
"Back-to-Back" Continuous Measurements	
"Individual" Continuous Measurements	
Measurement Blocks and Their Processing	12
Arming and How It Controls Measurement Timing	13
Holdoff (Block) Arming Capabilities	
Sample (Measurement) Arming Capabilities	
Holdoff/Sample Arming Capabilities	
Automatic Arming Capabilities	
Post-Arming Measurement Timing	17
Continuous Measurements	
Non-Continuous Measurements	
Setting the Input Trigger Levels	18
Specific HP 5371A Measurements and How They Are Made	19
Frequency and Period	
Continuous Time Interval	
Time Interval	
± Time Interval	
Phase	
Rise and Fall Time	
Positive and Negative Pulse Width	
Duty Cycle	
Totalize	
Peak Amplitude	
The Analysis Tools.....	22
Time Variation Graph Specifics	
Histogram Graph Specifics	
Event Timing Graph Specifics	
Statistics	
II. Specification Guide	28
Table of Contents	

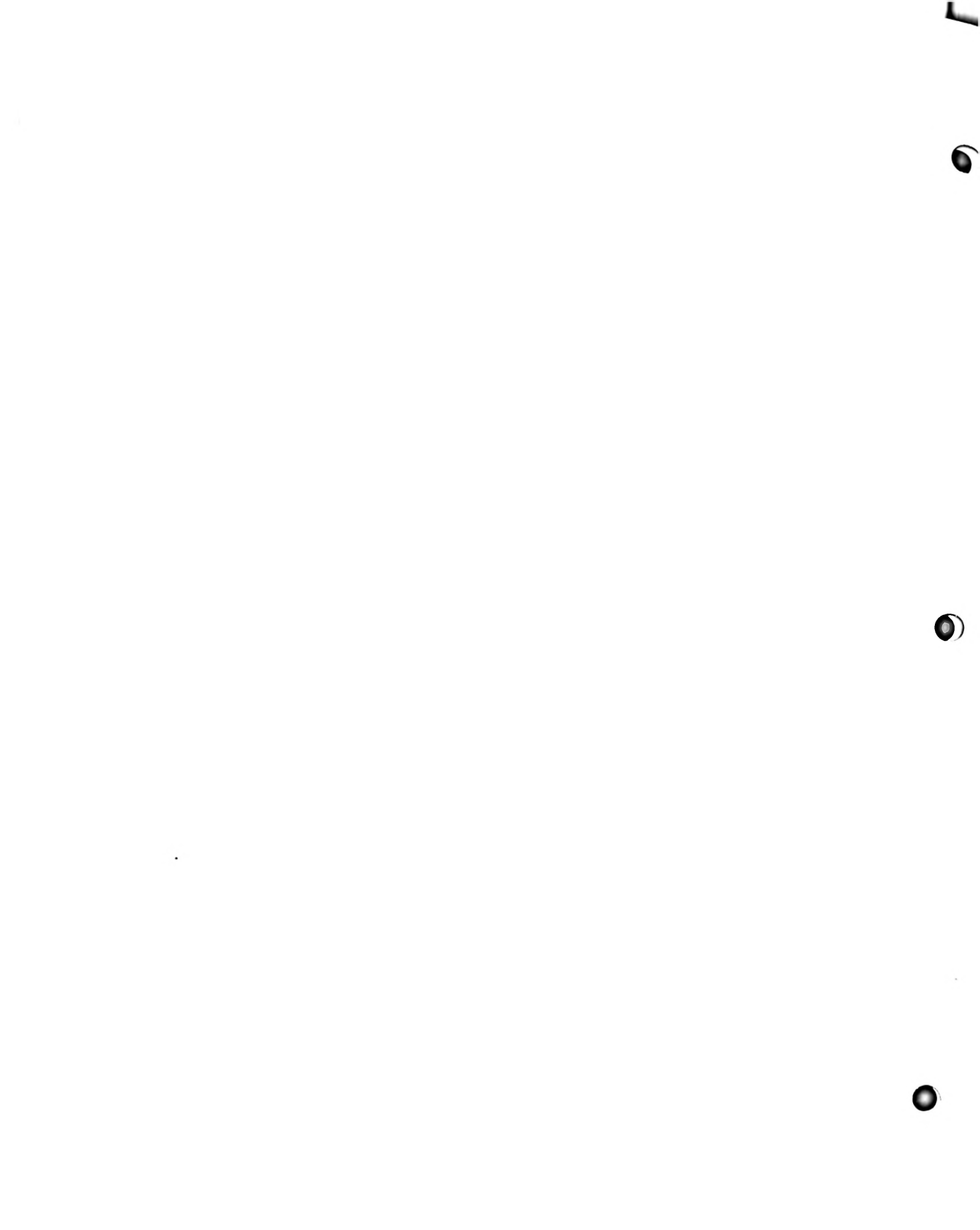

Continuous Measurement Concepts



The HP 5371A Frequency and Time Interval Analyzer takes a revolutionary new approach to frequency, period, time interval, phase, and totalize measurements. Called "continuous measurement" technology, this new approach gives the HP 5371A far more capability than the traditional universal counter. Added to the HP 5371A is the ability to analyze the data it takes in many different and revealing ways. One of these ways is to display measurements vs. time.

Let's take a look at what "continuous measurement" means for frequency and time interval measurements and see how displaying them vs. time gives you previously hidden information.

Frequency Measurements vs. Time

Basically, the HP 5371A does for frequency measurements what the digitizing oscilloscope does for voltage measurements. A voltmeter is an excellent tool for measuring voltages that are constant with time. But add voltage variations with time (ac), and voltmeters become limited in their ability to give the user time-related information.

In *Figure 1*, you can see that if the voltage is changing with time you may get some idea of the peak variations. Key parameters, such as the rate of change and the shape of the waveform, are unknown. A digitizing oscilloscope is the answer to these needs. It samples voltage at given times and graphically displays the resulting measurements in the order taken.

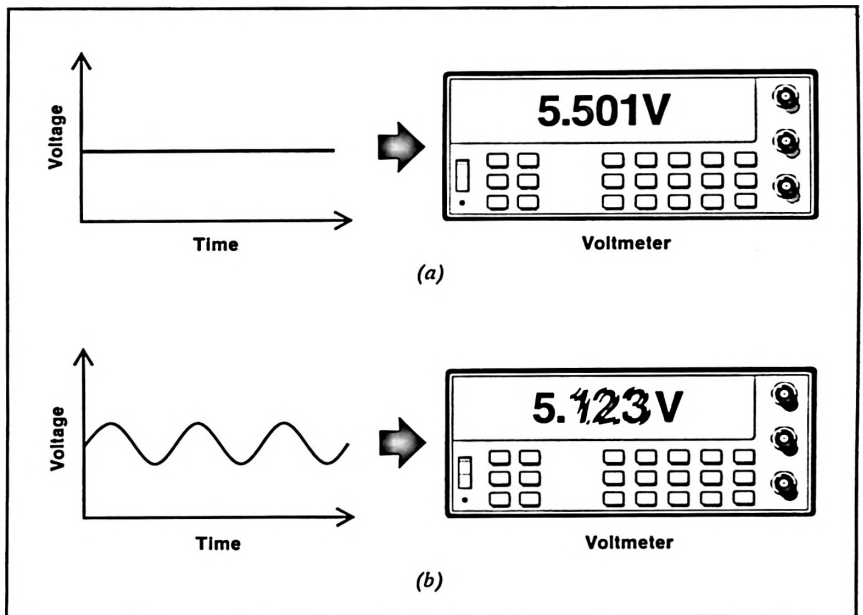

Figure 1 (a) and (b). A quantity like voltage that varies with time cannot be completely characterized by a single dimensional measurement device, such as a voltmeter.

The digitizing oscilloscope produces a picture of what is happening in time (Figure 2). From this you can easily determine key parameters that characterize the signal (\pm peaks, dc offset, frequency, and waveshape).

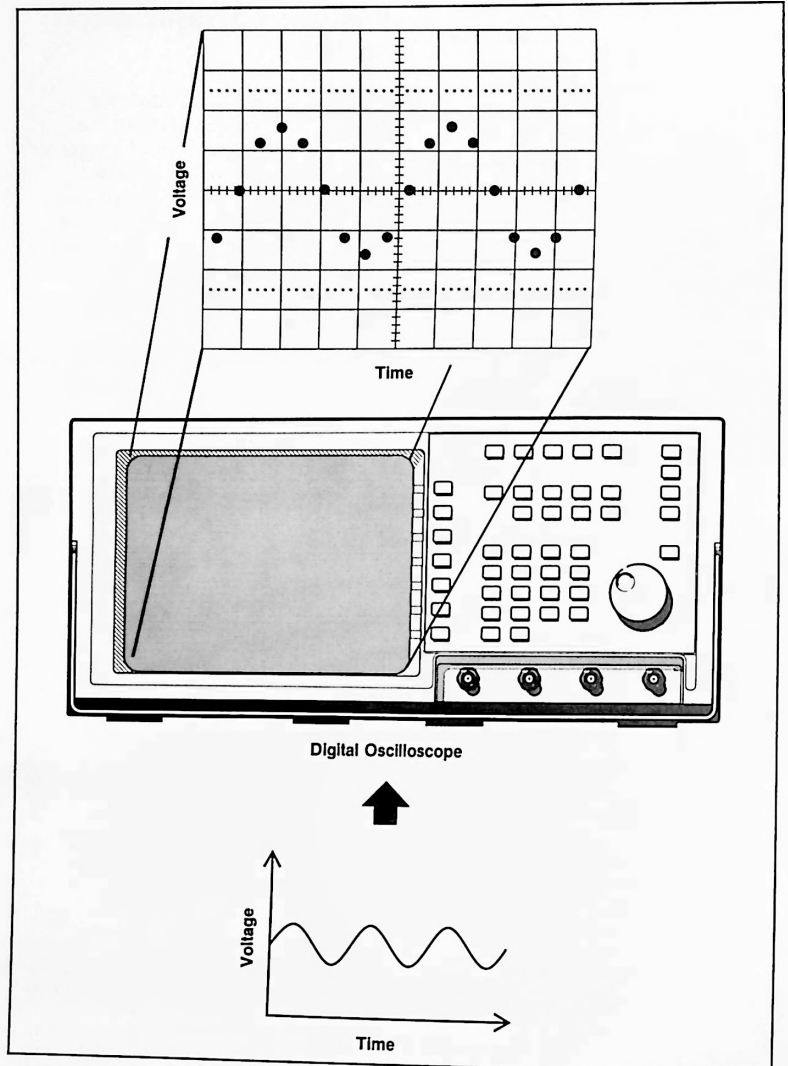

Figure 2. A digital oscilloscope displays voltage vs. time, thereby fully characterizing the waveform.



Now, consider a frequency that is constant with time. This is analogous to the dc voltage of the previous example (Figure 3(a)). Both share a common characteristic; they do not vary in value with time. As with the voltmeter, the frequency counter is an excellent tool for measuring a constant frequency. But add frequency variations with time (FM), and the frequency counter has the same measurement limitations as the voltmeter (Figure 3(b)).

Again, you can see that the frequency is changing with time, but you cannot determine all the parameters needed to characterize the signal. The HP 5371A Frequency and Time Interval Analyzer is the solution. It does for frequency what the digitizing oscilloscope does for voltage. In other words, it continuously samples frequency at given times and graphically (or numerically) displays the results in the order taken.

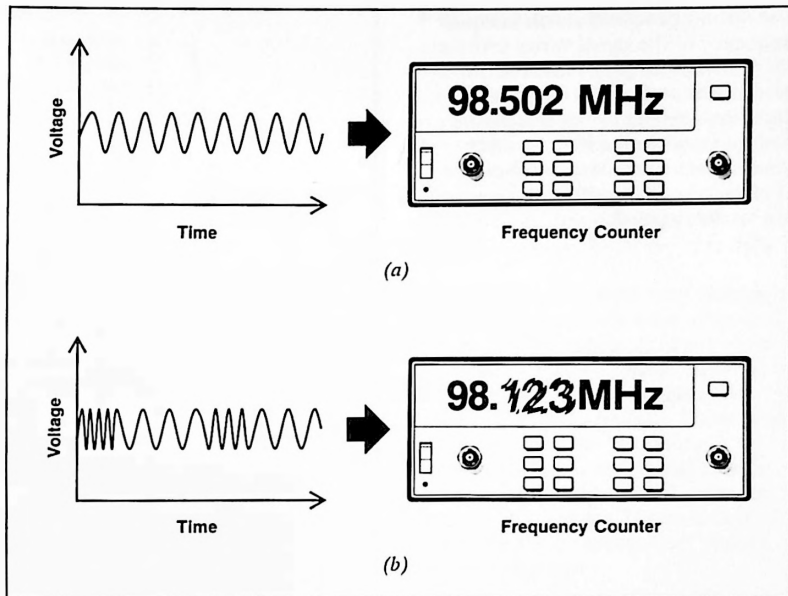

Figure 3. (a). A constant frequency can be easily characterized by a frequency counter. (b). Add time variation (FM), however, and the information is incomplete, similar to the voltmeter.

The display produced shows how the frequency of the signal varies with time (Figure 4(a) and (b)). Now key FM parameters such as peak-to-peak deviation, carrier frequency, modulation rate, and modulating waveform (analogous to \pm peaks, dc offset, rate of change, and waveshape for voltage) can be determined.

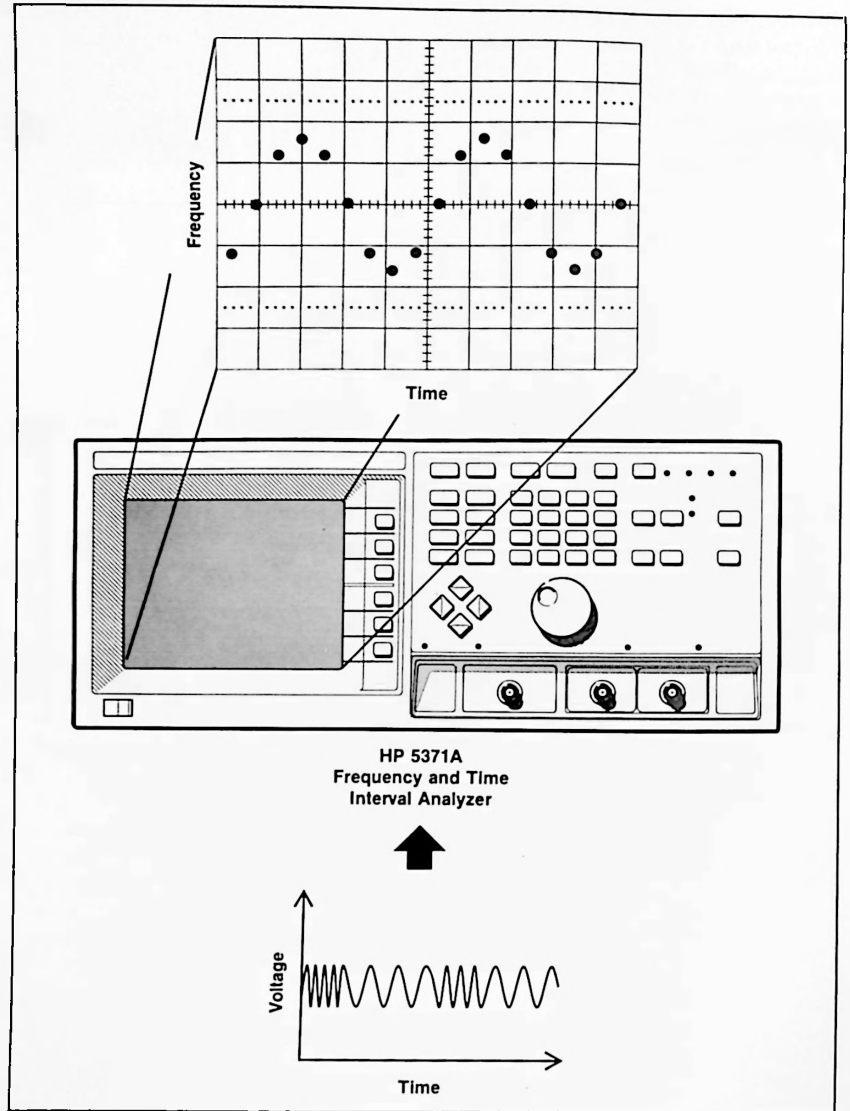
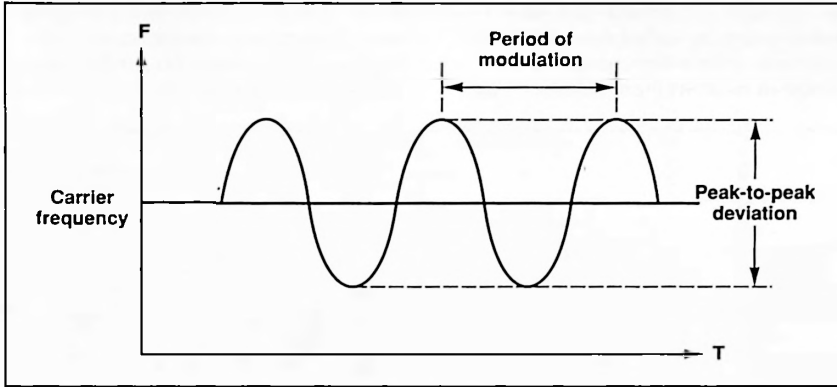

Figure 4(a). The HP 5371A Frequency and Time Interval Analyzer does for frequency what the digital oscilloscope does for voltage: it plots frequency vs. time, thus allowing complete characterization of the signal.



Frequency Sampling

The HP 5371A actually measures the time it takes for an integer number of cycles to occur (or integer multiples of 2π radians of phase) (see Figure 5(a)). Once the number of cycles and number of seconds is measured, the frequency is known during the sampling interval, as shown in Figure 5(b).

The HP 5371A's unique contribution to frequency sampling technology is that it samples frequency in a continuously timed, "back-to-back" fashion for up to 1000 measurements (4095 when remotely controlled). There is no processing time, or "dead time", between these measurements and the timing relationships of all these measurements are known. The processing is done after the measurement "block" has been acquired.

Figure 4(b). This figure shows how you quantify peak-peak deviation, carrier frequency and the period of the (frequency) modulating waveform.

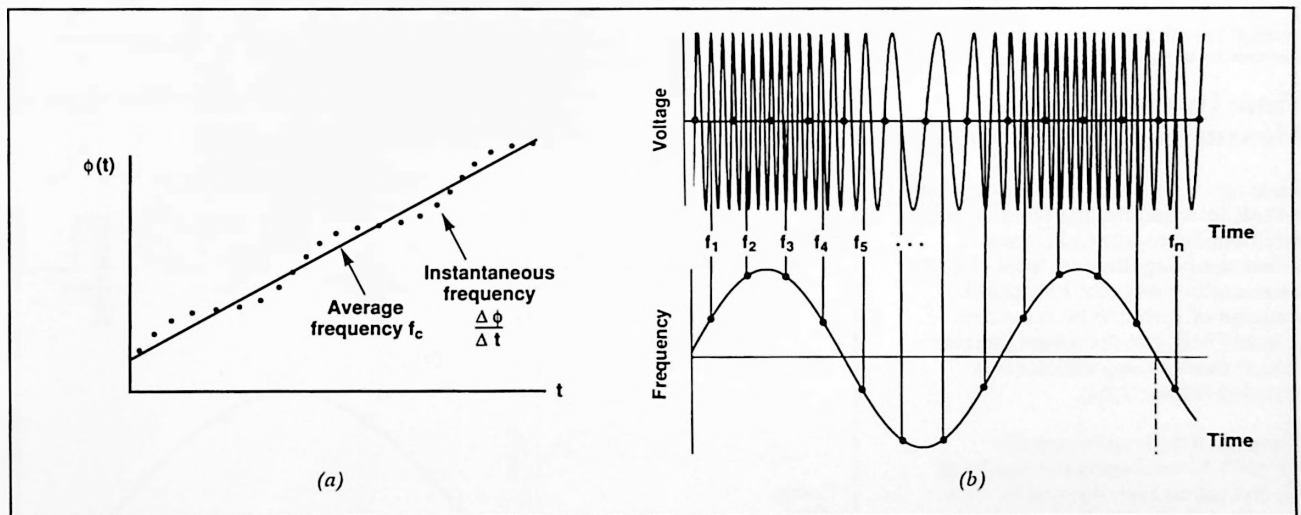

Figure 5. (a). This figure shows how the HP 5371A measures frequency. It precisely measures the time at which integer numbers of 2π radians of phase (or cycles) of the signal have occurred. (b). Frequency is calculated in the HP 5371A as the number of cycles that have occurred during each sampling interval.



The HP 5371A can sample frequencies up to 500 MHz in this manner. For a 1 second sample interval, frequency resolution is a constant 10 digits across

the 500 MHz bandwidth. Sample intervals may be varied from 100 ns to 8 seconds, with a corresponding change in measurement resolution as

shown in *Figure 6*. Note that averaging several frequency measurements can significantly enhance this resolution (see Specifications section).

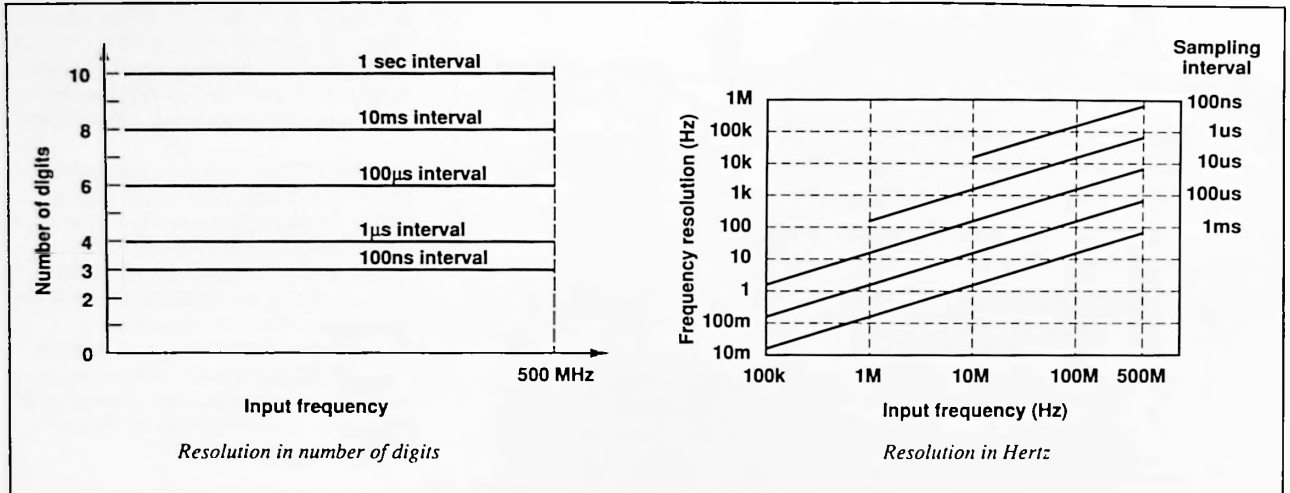

Figure 6. The HP 5371A's frequency resolution is a constant number of digits for a given sample interval across its bandwidth. Thus, resolution in hertz increases as the input frequency becomes lower, which is an important consideration when using down conversion.

Time Interval Measurements vs. Time

Once again, the time/phase sampling reveals information unattainable with traditional time interval counters. When sampling the time from clock to data continuously, not only can the statistics of variation be recovered (*Figure 7(a)*), but the actual jittering (phase modulating) waveform is revealed (*Figure 7(b)*).

Once the data is collected, the HP 5371A can display the results as the measured time interval vs. time. Results can also be displayed in a powerful histogram format (*Figure 8*), which can include the calculation of statistics, such as mean, standard deviation, root Allan variance and others (see discussion on page 26). This type of time interval analysis can be applied to signal characterization such as pulse position, pulse width, transition times and period.

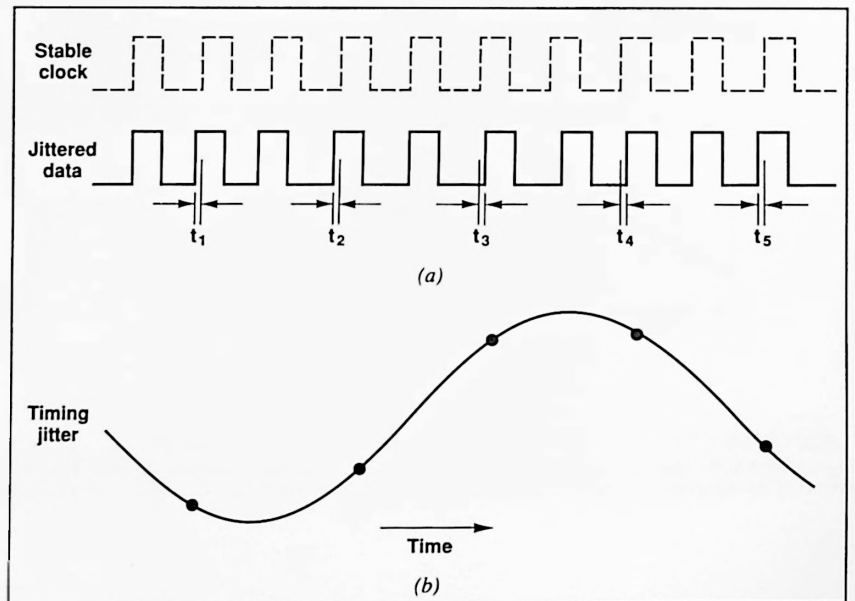

Figure 7. (a). Continuous (sampled) measurements of clock to data reveal more than the statistics of variation, (b) but the disturbing signal is extracted.

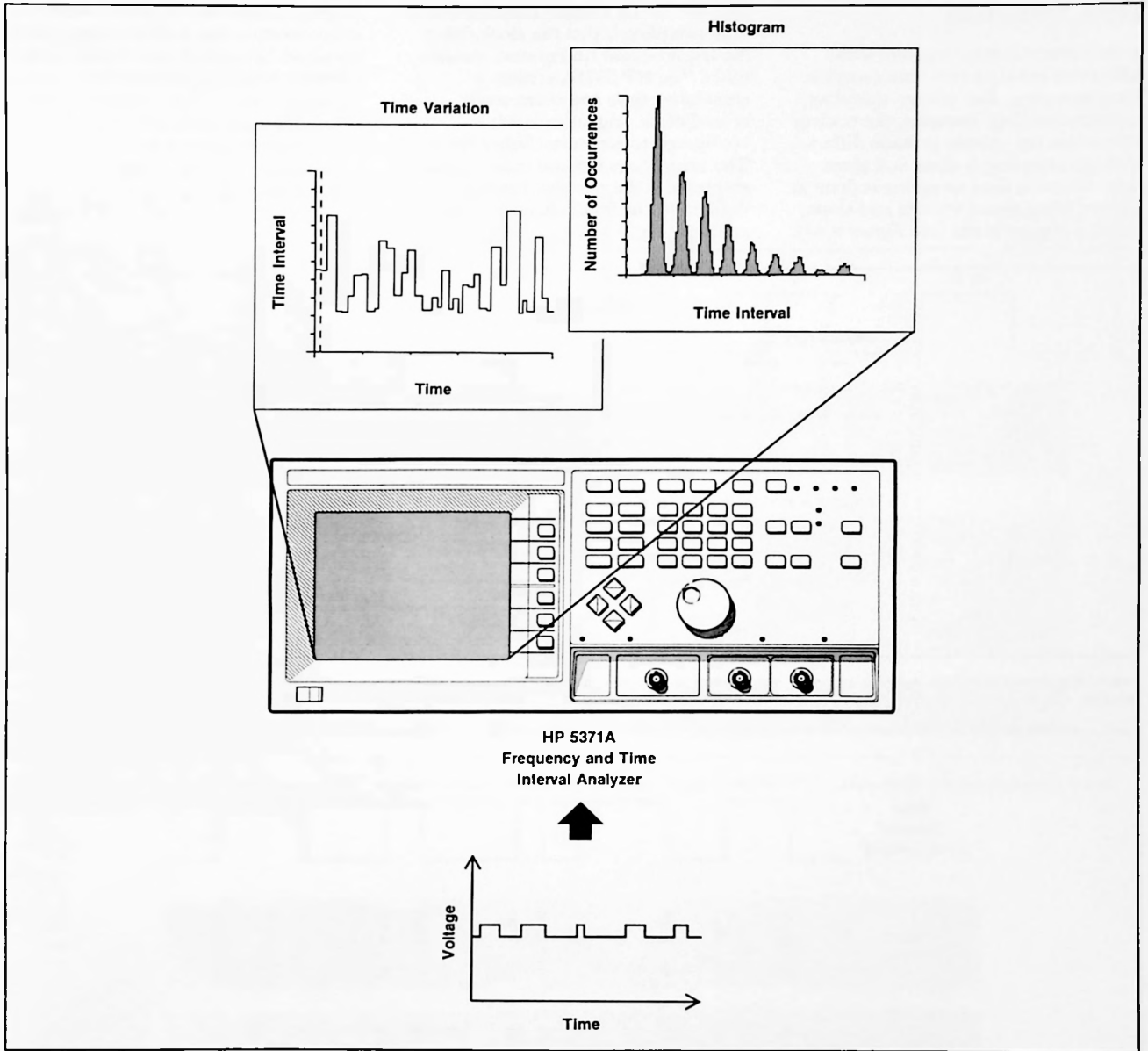

Figure 8. The HP 5371A has two powerful graphic tools for analyzing jitter: the Time Variation plot to point out trends and the Histogram for distribution and statistical analysis.

Time Sampling

A time interval measurement is the difference between two time samples. Time sampling, like voltage sampling, is point sampling, however, the control over when the sample is made differs. Voltage sampling is done at a given time, whereas time sampling is done at a given input signal voltage and slope, called a trigger event (see *Figure 9(a)*).

The HP 5371A's major contribution to time sampling is that the clock doing the trigger-event timing runs continuously. The HP 5371A creates a cumulative time and event count record of the trigger events it is configured to measure (*Figure 9(b)*). The actual time interval measurement displayed is the one that has been defined by the input channels' slope settings (e.g. + slope to - slope

displays positive pulse width), however, many other timing relationships can be obtained from the Event Timing graph (discussed further on page 26).

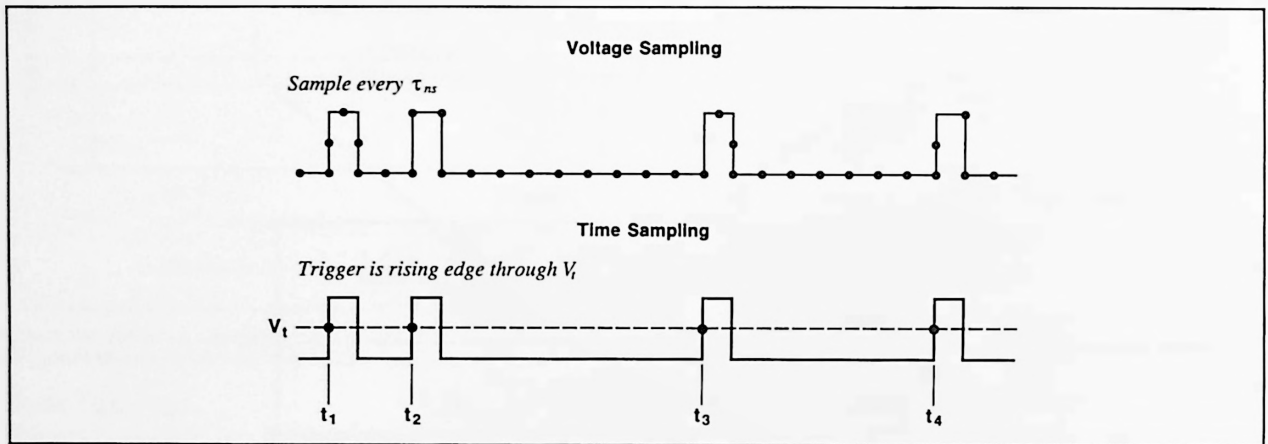

Figure 9(a). Whereas voltage samples are taken in a digitizer at repetitive intervals, time samples are taken in the HP 5371A when the trigger condition is satisfied.

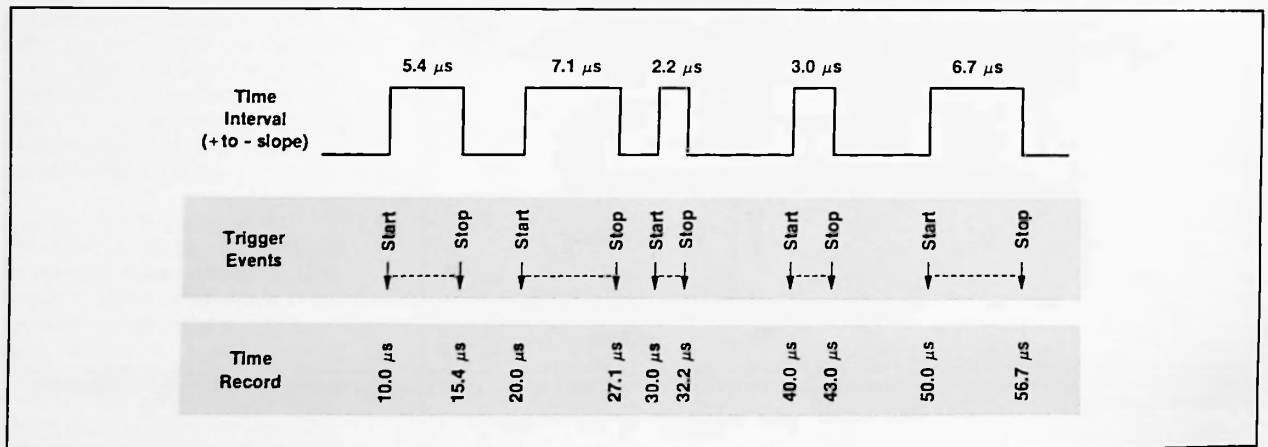

Figure 9(b). Time sampling is point sampling controlled by the input signal. The HP 5371A creates a running time record of these points, rather than measuring only the time interval, as does a time interval counter.

HP 5371A dual-channel time-interval measurements (TI A→B or TI B→A) can be made from +8 seconds down to zero seconds, to -8 seconds, with 150 ps rms resolution. The only restriction is that the time between time interval measurements be at least 200 ns. A trigger event that occurs sooner than this is *counted* but not *timed*, as shown in Figure 10.

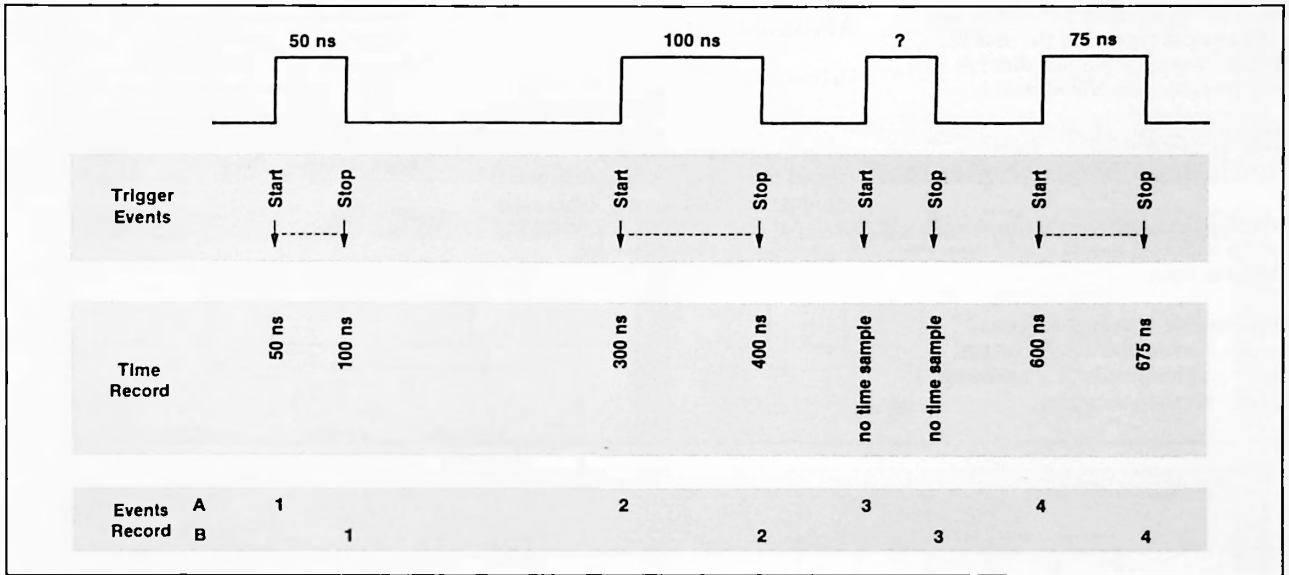

Figure 10. Time intervals as close together as 200 ns are measured to 150 ps rms resolution. Even if the HP 5371A cannot make the measurement, it will indicate how many events were "missed". You know precisely which events have been timed.

Continuous Measurement General Definitions



The HP 5371A performs two basic types of continuous measurements: 1) "back-to-back" measurements (like the frequency example in *Figure 11(e)*) where the stop of the n^{th} measurement is the start of the $n + 1$ measurement, and 2) "individual" measurements, where the measurement start and stop points are usually independent of adjacent measurements (like many of the examples in *Figure 11*). The definitions and requirements for these two measurement types and the specific HP 5371A measurements that fall into these types are described below.

"Back-to-Back" Continuous Measurements

Definition - measurements are contiguous with one another, and they are related in time.

Requirement - the measurement sample-interval must be between 100 ns and 8 seconds (4 seconds for 2 result measurements).

The HP 5371A measurements that fit into this type are Frequency, Period, Phase, Totalize, and Continuous Time Interval (fundamentally a period measurement). There are some arming modes for these measurements that break up their back-to-back nature and are therefore non-continuous (see Arming section on page 13).

"Individual" Continuous Measurements

Definition - after arming occurs, the first, and only the first, start and stop trigger-events cause time sampling to occur. Subsequent start and stop trigger events will be ignored until the arming condition is once again satisfied. All time samples are related to each other in time however.

Requirements -

- the start-to-stop time (measurement) must be 8 seconds or less, and
- the stop-to-start time (between measurements) must be at least 200 ns.

The HP 5371A measurements that fit into this type are Time Interval, \pm Time Interval, Positive Pulse Width, Negative Pulse Width, Rise Time, Fall Time, and Duty Cycle. Also, any "individual" continuous measurement will become non-continuous when the time between measurements is less than 200 ns.

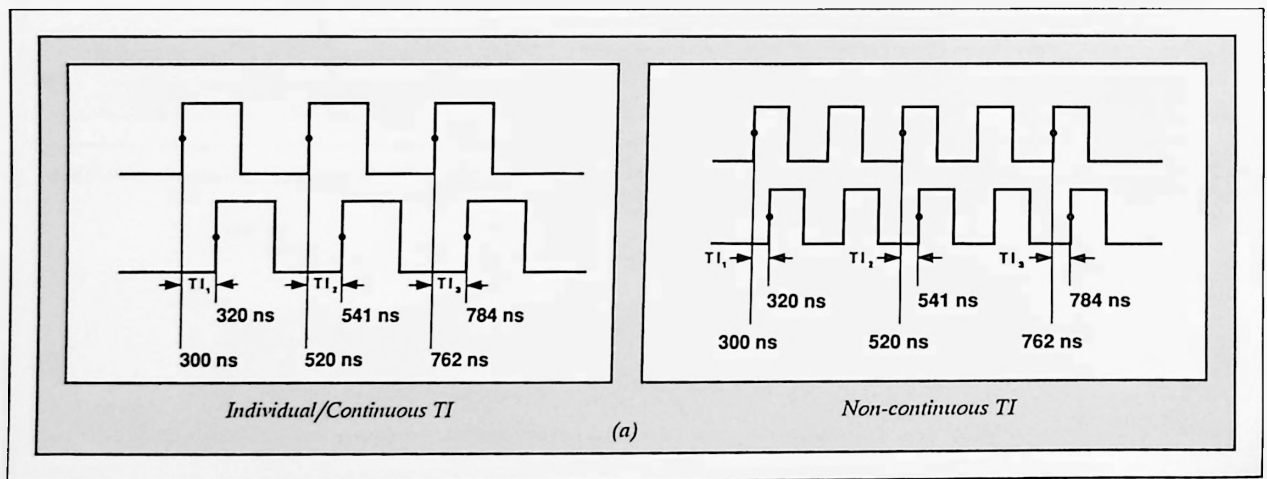
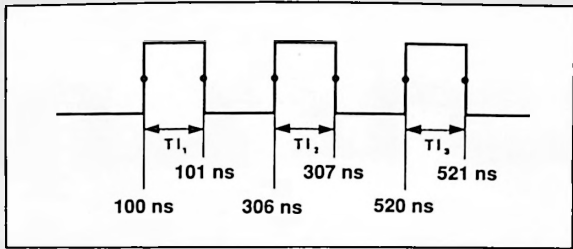
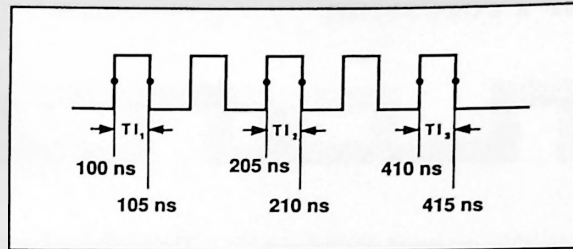

Figure 11. The graphs show the distinctions between "back-to-back" continuous, individual continuous and non-continuous measurements. "Back-to-back" continuous means only one trigger slope and level, and separations greater than 100 ns. Individual continuous means two trigger slopes and/or levels are used with separations greater than 200 ns. Non-continuous occurs when separations are less than 200 ns according to trigger selection.



Individual/Continuous TI



Non-continuous TI

(b)

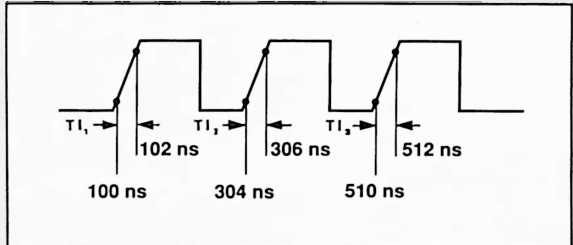

Individual/Continuous TI

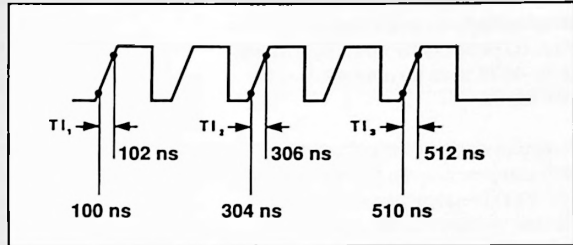

Non-continuous TI

(c)

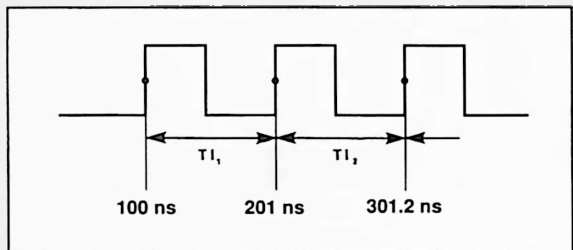

"Back-to-back" Continuous TI

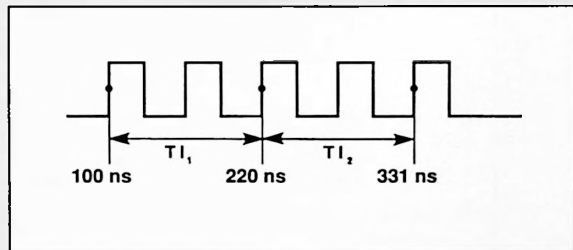

"Back-to-back" Continuous TI, but events have been missed.

(d)

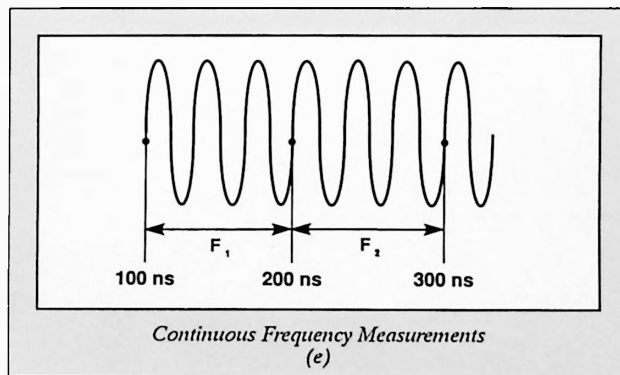

Continuous Frequency Measurements
(e)

Figure 11. (Continued)

Measurement Blocks and Their Processing



As previously mentioned, continuous measurements are made in "blocks" of up to 1000 measurements. Then acquisitions stop and results are processed by the HP 5371A or output to an external computer. When using an external computer with the HP 5371A to process the measurement data, up to 4095 measurements can be made per block.

For histogram and statistical analysis of the measurements, up to two million blocks of 1000 measurements can be taken in one measurement session. This allows up to two billion measurements to be cumulatively analyzed per session.

The number of measurements per block can range from 1 to 1000 and the number of blocks per session can range from 1 to 2,000,000 as long as the total measurements per session does not exceed 2,000,000,000.

For dual-result measurements, like (simultaneous) Frequency A&B, these ranges are reduced by half (i.e. 1 to 500 measurements per block) since two sets of data are taken per measurement. This restriction applies to the following measurements:

- Frequency A&B
- Period A&B
- Totalize A&B

For non-continuous measurements, the grouping and processing of the measurements are basically the same as for continuous measurements, only the arming is different (see Arming section on page 13). This allows a block of rapid non-continuous measurements to be made with minimal "dead time" between measurements.

Arming - and How It Controls Measurement Timing

Arming provides a wide range of control over when a block begins and when measurement sampling occurs within that block. When the HP 5371A is "armed", it is ready to start or stop measuring at the next edge which satisfies the trigger condition. Note that this does not mean it has started measuring. The following section, groups the arming modes into major categories and then discusses each mode in detail.

There are 23 different arming modes available in the HP 5371A (see Table 2, inside back cover). These can be divided into four major categories.

1) **Automatic mode** - this is the easiest way to make a measurement. Measurements are made as soon as possible and as fast as possible.

2) **Holdoff modes** - here the start of the measurement block is held off. However, the measurements within the block are made as quickly as possible.

3) **Sampling modes** - the block starts as soon as possible. However the measurements within the block are paced.

4) **Holdoff/Sampling modes** - these are modes in which both the block and the measurements within the block are paced.

"Holdoff" applies to when a block of measurements begins and "Sampling" applies to when the measurements are armed to be made within the block. Exactly when and how the actual measurements are made after arming occurs will be discussed beginning on page 17. This section focuses only on the measurement arming itself.

As shown in Table 2 (inside back cover), there are seven non-continuous arming modes (Peak Amplitude is a non-continuous measurement). For these modes, arming primarily controls the measurements' duration as opposed to continuous measurements where arming controls their pace. The

"block/measurement" arming becomes "start/stop" arming of a single measurement, rather than a series of measurements. The HP 5371A's Function screen automatically accounts for this difference when an arming mode is selected (Figure 12(a) and (b)).

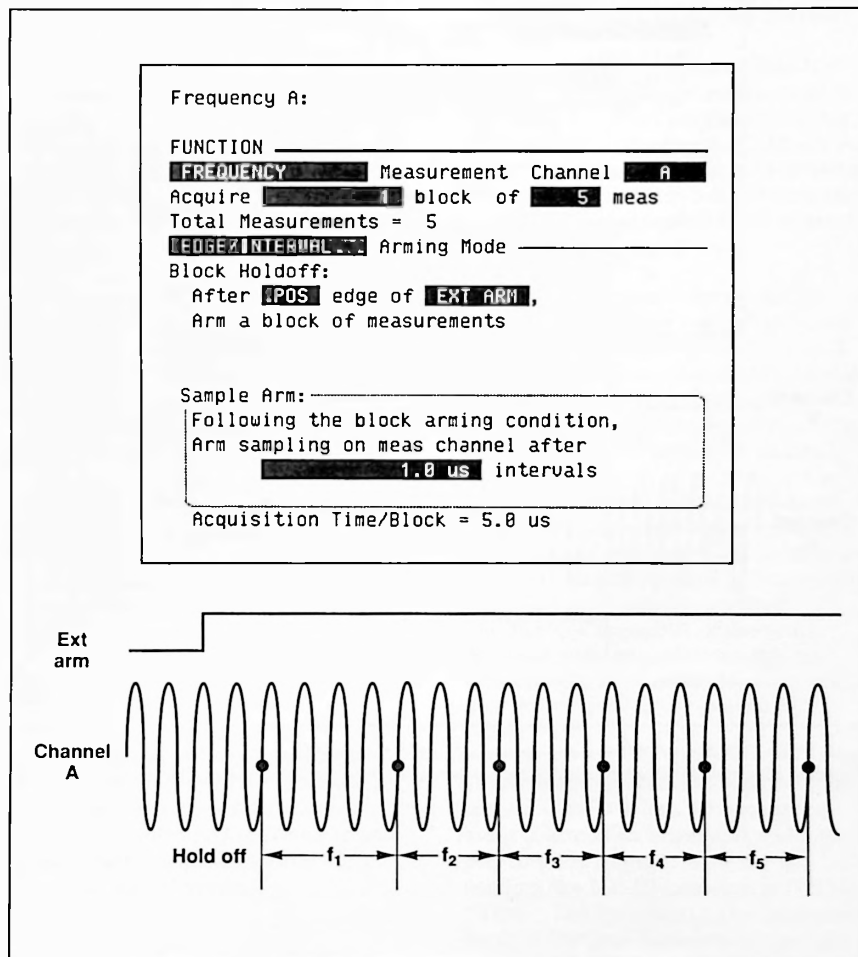

Figure 12(a). Continuous measurements consist of a block of samples with no processing between samples. EDGE/INTERVAL here means hold off the block until a POSitive edge of EXTERNAL ARM, then pace the measurements at 1.0µs INTERVALS.

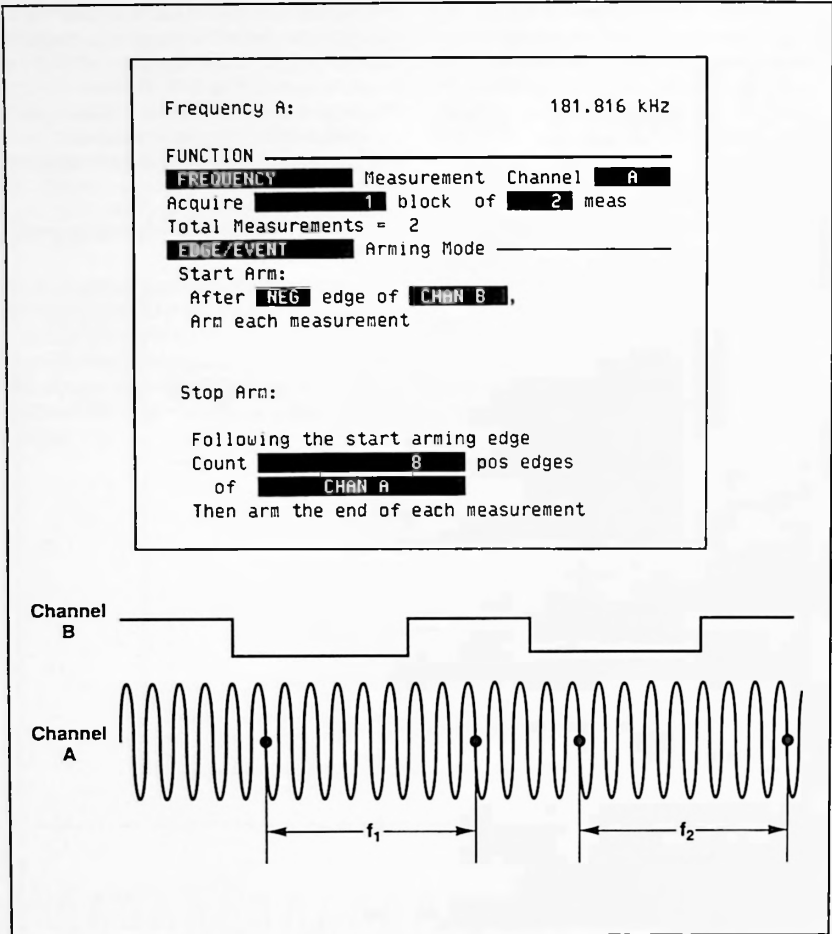

Figure 12(b). EDGE/EVENT is a non-continuous arming mode. Here, the start is paced by a NEGative edge on CHANnel B, and the stop is armed after 8 negative edges of CHANnel A.

Holdoff (Block) Arming Capabilities

There are three ways to control when a block of measurements will be started. Once the block is started, measurements are made as quickly as possible thereafter.

1) **Edge Holdoff** - the measurement series is armed to start after a user-defined trigger event (input voltage and slope) on Channels A, B, or External Arm (you give the HP 5371A an edge).

2) **Time Holdoff** - similar to Edge Holdoff except that a user-specified time delay is added between the trigger event (edge) and the arming of the measurement series.

3) **Event Holdoff** - the same as Edge Holdoff except that a user-specified number of Channel A or B events is added between the edge and the arming of the series.

Sample (Measurement) Arming Capabilities

There are five basic ways to control the pace at which measurements are made within a block. The block will start automatically.

1) **Interval Sampling** - sampling is armed at a user-specified rate (interval of time). The interval is referenced from either the arming of the block or the end of the previous interval.



2) **Time Sampling** - performs a non-continuous frequency or period measurement with a user specified sample interval. The sample-interval time resolution is more precise in this mode than for Interval Sampling. The measurement will begin when the HP 5371A is ready.

3) **Cycle Sampling** - similar to Interval Sampling except that a user-specified number of Channel A, B, or internal 2 ns timebase events (cycles) is used to determine the sample interval. Choices for the number of events is restricted to 2^4 , 2^8 , 2^{12} , 2^{16} , 2^{20} , 2^{24} , or 2^{28} .

4) **Edge Sampling and Repetitive Edge Sampling** - sampling is armed to occur after a trigger event (edge) on Channels A, B, or External Arm. The edge may or may not be part of the measured signal. This is called "Edge Sampling" for frequency, period, and totalize measurements, and "Repetitive Edge" for time interval measurements.

5) **Parity and Repetitive Parity Sampling** - these arming modes are used only for \pm Time Interval and will be discussed on page 20 with that measurement.

Holdoff/Sample Arming Capabilities

These 12 modes are basically combinations of the above Holdoff and Sampling modes. Holdoff will arm the start of the measurement block and Sampling will set the pace at which the measurements are made within the block. For non-continuous measurements, Holdoff (Start) arms the beginning of a single measurement and Sampling (Stop) arms its end.

1) **Edge/Interval** - the measurements are armed to start after an edge on Channels A, B, or External Arm and arming is paced by the user-specified interval.

2) **Edge/Time** - a non-continuous mode. The measurement is armed to begin after an edge on Channels A, B, or External Arm and is armed to end after a user-specified time.

3) **Edge/Edge** - the measurements are armed to start after an edge on Channels A, B, or External Arm and are paced by an edge on Channels A, B, or External Arm. The two edges do not have to come from the same channel.

4) **Externally Gated** - a non-continuous mode. The positive or the negative pulse width of a signal on Channels A, B, or External Arm arm the beginning and end of the measurement. The minimum time between measurements is only 200 ns.

5) **Edge/Cycle** - the measurements are armed to start after an edge on Channels A, B, or External Arm and arming is paced by the user-specified number of Channel A, B, or internal timebase (2 ns) events (cycles). Choices for the number of events is restricted to 2^4 , 2^8 , 2^{12} , 2^{16} , 2^{20} , 2^{24} , or 2^{28} .

6) **Edge/Event** - a non-continuous mode. The measurement is armed to begin after an edge on Channels A, B, or External Arm and is armed to end after a user-specified number of Channel A or B events.

7) **Edge/Parity** - this arming mode is used for \pm Time Interval only and will be discussed with that measurement.

8) **Time/Interval** - the measurements are armed to start after a user-specified time that is referenced to an edge on Channels A, B, or External Arm. The arming of the measurement series is paced by a user-specified interval.

9) **Time/Time** - a non-continuous mode. The measurement is armed to begin after a user-specified time that is referenced to an edge on Channels A, B, or External Arm. The measurement is armed to end after a separately set, user-specified time that is referenced to the same edge.

10) **Event/Interval** - the measurements are armed to start after a user-specified number of Channel A or B events which are referenced to an edge on Channels A, B, or External Arm. The measurement arming of the series is paced by a user-specified interval.

11) **Event/Event** - a non-continuous mode. The measurement is armed to begin after a user-specified number of Channel A or B events and is armed to end after a separately specified number of Channel A or B events. Both are referenced to an edge on Channels A, B, or External Arm and the "start" must occur before the "stop".

12) **Manual** - a non-continuous mode for use with Totalize. The measurement is armed to begin and end after pressing the Manual Arm key or sending the HP-IB commands GET or *TRG. The duration of the measurement is the time between key presses or HP-IB commands.



Automatic Arming Capabilities

Automatic arming is the easiest way to make a measurement since almost all of the arming parameters have been chosen for you. The HP 5371A measurements and the related arming presets are listed in *Table 1*.

Table 1. Automatic Arming Configurations

<p>Measurement:</p> <ul style="list-style-type: none">■ Single-channel Frequency (A or B)■ Single-channel Period (A or B)■ Continuous Time Interval <p>Preset</p> <p>Automatic arming: causes the HP 5371A to acquire data as quickly as possible. Minimum sample interval is 100 ns.</p>
<p>Measurement:</p> <ul style="list-style-type: none">■ Dual-channel Frequency (A&B, A/B, B/A, A+B, A-B, B-A)■ Dual-channel Period (A&B, A/B, B/A, A+B, A-B, B-A)■ Time Interval■ Time Interval■ Phase <p>Preset:</p> <p>Automatic arming: causes the HP 5371A to acquire data as quickly as possible. Minimum sample interval is 200 ns.</p>
<p>Measurement:</p> <ul style="list-style-type: none">■ Rise Time■ Fall Time■ Positive Pulse Width■ Negative Pulse Width■ Duty Cycle <p>Preset:</p> <p>Automatic arming is actually Repetitive Edge Sampling where the edge is defined as a negative-slope trigger event on Channel A (the measurement channel) for Rise Time, Positive Pulse Width, and Duty Cycle. For Fall Time and Negative Pulse Width, the edge is defined as a positive-slope trigger event on Channel A.</p>
<p>Measurement:</p> <ul style="list-style-type: none">■ Peak Amplitude <p>Preset:</p> <p>Automatic arming is a non-continuous, free-running mode where the duration of the measurement is 100 ms and the time between measurements is 100 ms.</p>

Post-Arming Measurement Timing

When and how a measurement is armed has been discussed in the previous section. This section examines when and how the actual measurement itself is made.

Continuous Measurements

As discussed previously, continuous measurements are divided into two basic types, "back-to-back" and "individual" measurements.

For "back-to-back" continuous measurements, sample (measurement) arming arms the point where one measurement stops and the next measurement starts (called the back-to-back start/stop point). Exactly when this point occurs after arming is completed depends on the measurement. Thus, a further division of the "back-to-back" measurement into "Totalize" and "Frequency/Period/Phase/Continuous Time Interval" subcategories is required.

For Totalize measurements - the start/stop point occurs when the arming is completed. The arming point and start/stop point are identical (*Figure 13(a)*).

Frequency/Period/Phase/Continuous Time Interval measurements -

- The start/stop point is synchronized with the next trigger event of the measured signal (*Figure 13(b)*).
- For Frequency/Period dual-channel measurements: the start/stop point is synchronized with the next Channel B trigger event after one Channel A trigger event has occurred.

The start point of a block's first measurement is made in the same way except that Holdoff (block) arming is used to arm it.

"Individual" continuous measurements are all basically time interval measurements. As was described earlier, a time interval measurement is the difference between two time samples. These two time samples are taken at the next user-defined start and stop trigger events after arming (holdoff or sample) is completed.

Non-Continuous Measurements

Non-continuous measurements are single measurements where arming controls the measurement's beginning and end points (i.e. start/stop arming instead of block/measurement arming).

For Totalize and Frequency/Period measurements, the timing of the beginning and end points after arming is the same as for continuous measurements.

For \pm Time Interval measurements, the timing of the first time sample remains the same, however, the second time sample (the time-interval stop sample) can also be delayed by the arming mode. Thus, both the start sample and the stop sample can be delayed in time. This is unlike continuous measurements where only the start of the measurement can be delayed.

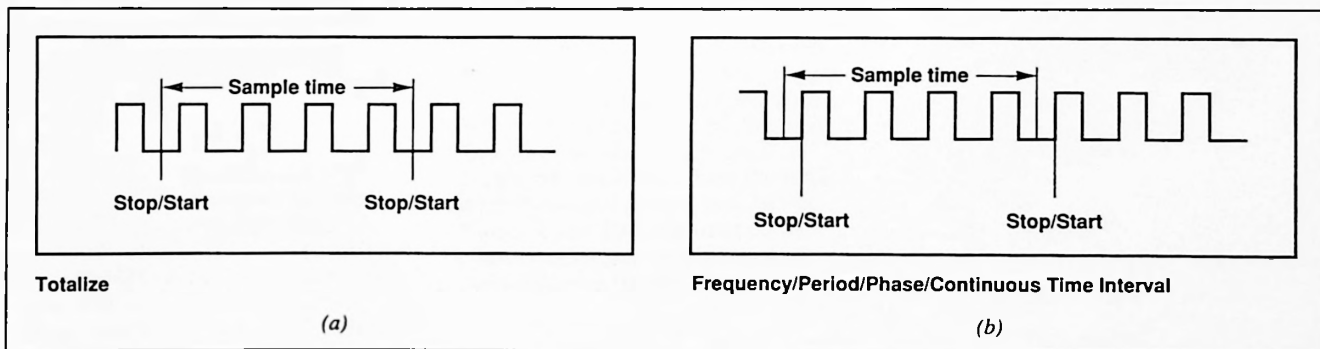

Figure 13(a). For the Totalize measurement, the arming and start/stop points are identical, (b) but for Frequency, Period, Phase and Continuous Time-Interval, the measurement will start/stop at the first trigger event following the arming.

Setting the Input Trigger Levels



Setting trigger level voltage is usually the more difficult of the two parameters that define an input trigger event (input voltage and slope). The HP 5371A makes this easier by offering three ways to set the trigger level on Channels A and B.

1) Manual - this is the traditional way of setting trigger levels by specifying the voltage. The range is ± 2 Vdc in 2 mV steps with the attenuator in the 1:1 position. In the 2.5:1 position the range is ± 5 Vdc in 5 mV steps.

2) Single Auto Trigger - the user specifies the trigger level as a percentage of the input peak-to-peak signal. The HP 5371A will then set and display the corresponding voltage level at the beginning of the measurement session. The range is 0% to 100% in 1% steps.

3) Repetitive Auto Trigger - this is similar to the Single Auto Trigger mode except that the HP5371A will set the corresponding voltage at the beginning of each measurement block for multiple block measurements.

Auto Trigger modes require that Channel A and/or B signals be present for 200 ms prior to the first block (Single), or each block (Repetitive) of a measurement session. This requirement is only 100 ms for Frequency, Period, and Totalize A or B; Time

Interval and \pm Time Interval A or B; and Continuous Time Interval.

This mode does not work, then, for low duty cycle signals such as pulsed RF and infrequent edges.

Frequency B:

INPUT _____

SEPARATE Input Channels

Trigger Event:

	Slope	Mode	Level
Chan A:	NEG	MANUAL	0 V
Chan B:	POS	SGL AUTO	50 % = 316 mV

Ext Arm Level **0 V**

	Channel A	Channel B
Input Pod	HP 54003A	HP 54002A
Impedance	1 Mohm	50 ohm
Bias Level	GND	GND
Attenuation	1:1	1:1
Maximum Input	2 V peak	2 V peak

Figure 14. This shows the menu for defining input parameters. Note the selections of Manual and Single Auto Trigger for channels A&B.

Specific HP 5371A Measurements and How They Are Made

This section describes how each HP 5371A measurement is made and computed, including any arming considerations.

Frequency and Period

Frequency and period will be discussed together since they are armed and measured in exactly the same way. They differ only in the computation of the measurements, as $\text{Frequency} = 1/\text{Period}$. Single-channel measurements can be made on Channels A or B. Dual-channel measurements (A&B, A/B, B/A, A+B, A-B, B-A) are made simultaneously. All of the above can be “back-to-back” measurements.

Frequency/Period measurements are made over a user-specified sample interval that is synchronized to the input signal's trigger events. If this interval is equal to the period of the signal, then a single cycle Frequency/Period measurement will result. If the interval is shorter than the period of the signal, then the sample interval defaults to the period of the signal, resulting in a single cycle measurement. If the interval is longer than the period of the signal, the calculation will be the average value of the Frequency/Period during that time. For dual-channel measurements (A&B, etc.), the slower of the two signals will determine the sample interval.

Automatic arming sets the sample interval to 100 ns for single-channel measurements. Therefore, all Frequency/Period measurements of 10 MHz and below are single cycle measurements and all measurements above 10 MHz are averaged measurements. For dual-channel measurements, these numbers become 200 ns and 5 MHz. Non-continuous arming modes will allow sample intervals of less than 100 ns.

Continuous Time Interval

This measurement is similar to a period measurement since it can only be made between like trigger events (input voltage and slope) on a given input channel (A or B). It does provide Holdoff arming options that are not available for Period. Continuous Time Interval is a “back-to-back” measurement and all arming modes are continuous.

The only other difference from a Period measurement is that when the sample interval is longer than the period, the measurements are not automatically averaged. The measurement results displayed will be the number of events (periods) that took place during the sample interval and the exact time of the interval.

Time Interval

This measures positive time intervals from 10 ns to 8 seconds in duration with 150 ps rms resolution. Measurements can be made from channels A→B, B→A, A or B, where the first channel listed is the start channel and the second is the stop channel.

These are “individual” type measurements with a 200 ns minimum spacing requirement. If the spacing between time intervals is less than this, trigger events will be counted but not timed. When 200 ns have elapsed, the next time interval will be measured. Displayed results will show the time interval measurements and, on the Numeric and Graphic screens, the number of trigger events that took place between the two time intervals.

Automatic arming allows you to measure every time interval the HP 5371A receives, provided the 200 ns spacing requirement is met. Interval Sampling, Repetitive Edge Sampling, and Edge/Interval arming allow you to skip unwanted time interval measurements.

± Time Interval

With this measurement both positive and negative time intervals of up to 4 seconds duration can be measured. Measurements can be made from channels A→B, B→A, A or B, where the first channel listed is defined as the start channel and the second is the stop channel. If a stop trigger event occurs before a start trigger event, the time interval displayed will be negative.

These are “individual” measurements with a 200 ns minimum spacing requirement. If the spacing between time intervals is less, the displayed results will be the same as for Time Interval.

Automatic arming allows you to measure every time interval provided the 200 ns spacing requirement is met. Other arming modes allow you to skip unwanted time interval measurements.



The unique Parity arming modes allow you to establish a given relationship (a pairing) between two similar signals at the beginning of a measurement session. This relationship is then held throughout the session, even if the spacing between measurements becomes less than 200 ns.

There are three different Parity arming modes available. For these modes, the pairing relationship is established after the arming of the first block and before the first measurement is made. The first Channel A and B trigger events received by the HP 5371A become the pair. From that point onward, every subsequent pair will produce an internal signal that is used to synchronize all further arming. This keeps asynchronous arming from breaking apart the pairs.

- 1) Parity Sampling - sampling occurs after a parity signal is generated. The block will start automatically.
- 2) Edge/Parity - the block is armed to start after an edge on Channels A, B, or External Arm and the measurements are paced by the parity signal.
- 3) Repetitive Parity - sampling occurs after an edge on Channels A, B, or External Arm is received and a parity signal is generated. The block will start automatically.

Since parity is checked before each measurement, Parity Sampling and Edge/Parity will measure every other time interval. Edge/Parity allows you to determine when the blocks will begin. Repetitive Parity allows you to skip unwanted time intervals.

Phase

Phase measurements require a reference signal, which can be supplied to either Channel A or B. The measurements available are Phase A Relative to B, or Phase B Relative to A, expressed in degrees. These are "back-to-back" measurements. (Note that single channel phase measurement can be achieved by measuring continuous time interval, period or frequency.)

The measurement is the combination of two measurements: a Period measurement and a \pm Time Interval measurement. The Period measurement is made on the reference signal while a simultaneous \pm Time Interval measurement is being made between the positive edges (at the 50% points) of the two signals. If the reference signal's edge occurs before the test signal's edge, the Phase is positive. Also, all phase changes are referenced to the first measurement made in the block, therefore, measurements of more than 360 degrees are possible within a block.



Rise and Fall Time

These two measurements will be discussed together as they are complements of each other. These are “individual” measurements with a 200 ns minimum spacing requirement and they can be made on Channel A only.

The start and stop points are automatically set to 20% and 80% of the input signal's peak-to-peak amplitude. Percentages may be modified by the user via the Input screen or trigger level voltages may be set.

The HP 5371A will measure every other transition, since one transition is required to arm the measurement. If the spacing between measurements is less than 200 ns, the transitions will be counted but not timed. When the 200 ns has elapsed, the next armed transition will be measured. The displayed results will show the measurements and, on the Numeric and Graphic screens, the number of transitions that took place between the measurements.

Positive and Negative Pulse Width

These two measurements will be discussed together as they are also complements of each other. These are “individual” measurements with a 200 ns minimum spacing requirement and they can be made on Channel A only.

The start and stop points are automatically set on opposite slopes to 50% of the input signal's peak-to-peak amplitude. The trigger level percentage may be modified by the user or trigger level voltages may be set.

The HP 5371A will measure every other pulse width since one width is required to arm the measurement. If the spacing between measurements is less than 200 ns, the displayed results show the count of the number of events missed as well as the timed results.

Duty Cycle

Duty Cycle measures the positive pulse width as a percentage of the signal's period. This is an “individual” measurement with a 200 ns minimum spacing requirement and it can be made on Channel A only.

The measurement is the combination of two measurements: a Period measurement and a Positive Pulse Width measurement. These measurements are made simultaneously at the 50% point of the signal. The trigger level percentage may be modified by the user or trigger level voltages may be set.

The HP 5371A will measure every other period, since one period is required to arm the measurement. If the period is less than 200 ns, the HP 5371A will period average over the 200 ns.

Totalize

Single-channel Totalize measurements can be made on Channels A or B. Dual channel Totalize measurements (A&B, A/B, B/A, A + B, A-B, B-A) are all made simultaneously. These are all “back-to-back” type measurements.

Totalize measurements are made over a user-specified sample interval that is not synchronized to the input signal's trigger events.

For all arming modes, except Manual, the count total is reset with each measurement. For Manual arming, the cumulative count total is displayed until the Reset key is pressed, regardless of the number of times the count is interrupted.

Peak Amplitude

This is a non-continuous, free-running measurement of the Channel A or B peak-to-peak amplitudes. The ac voltage from 1 kHz to 200 MHz, 200 mV to 2V peak-to-peak can be measured. The measurement time is 100 ms and the time between measurements is 100 ms. Dc voltage measurements, within the $\pm 2V$ range of the inputs ($\pm 5V$ with the 2.5:1 attenuator selected), can also be made. Peak amplitude is not intended for measuring amplitude modulated signals.

The Analysis Tools

There are two ways to graphically display the results of all continuous, and most non-continuous measurements.

1) Time Variation graph - plots the measurement's value versus the time at which it was taken, for the last block of a measurement session. This graph is useful for characterizing the nature of measurement variations such as trends, transients and frequency of phase modulation (Figure 15).

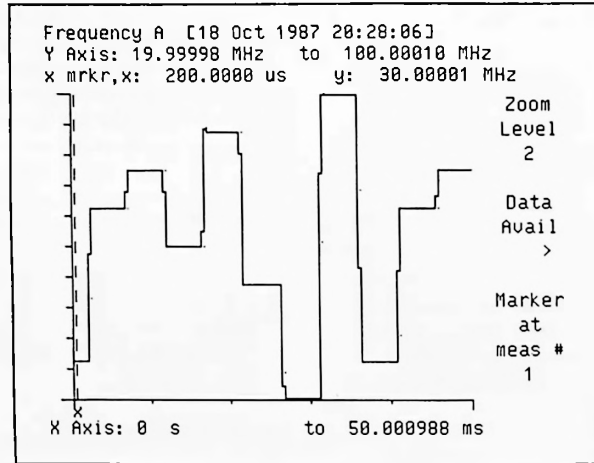

Figure 15. Trends and transients are easily seen when using the time variation mode. Here we see a frequency agile carrier hopping.

2) Histogram graph - plots the number of times a given measurement value occurs versus the ordered range of these values. This can be done for each block, or cumulatively for the entire set of blocks taken during a measurement session. This graph is useful for determining measurement distribution and statistics (Figure 16).

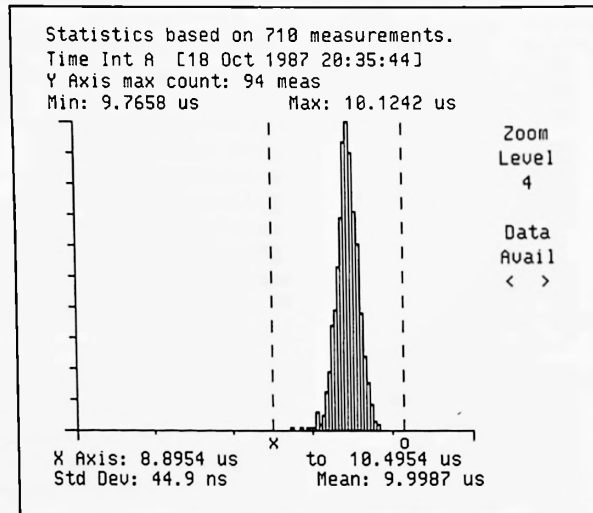

Figure 16. This figure shows the histogram plot, an excellent way of looking at varying phenomena. Here, a series of (nominal) 10us pulse widths are analyzed. Statistics can also be calculated and displayed for this distribution.

For all time interval measurements, a third graph is available.

3) Event Timing graph - shows, in a linear fashion, all the start and stop events received during the last block of a measurement session. The upward ticks are the start events and the downward ticks are the stop events. Markers then allow you to measure the time between any two trigger events (Figure 17).

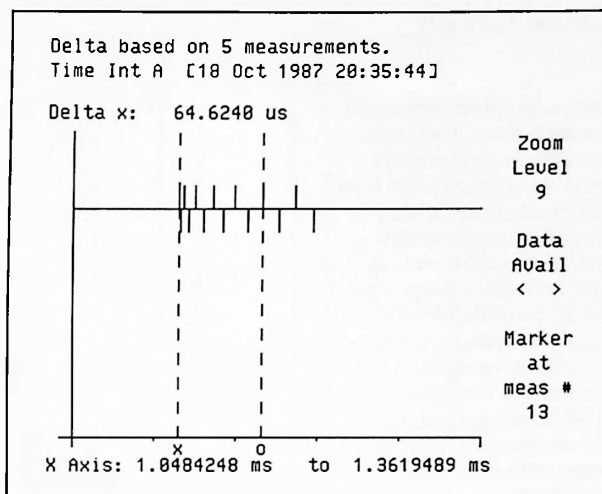

Figure 17. In the event timing mode, the time interval between any two events in a long series can be measured with full (150 ps rms) resolution.

The following capabilities are available for the above graphs.

Markers - two markers (X and O) are available for displaying the X-axis and Y-axis values of individual points, determining the differences between these two points (delta), or marking an area for further analysis.

Zooming - this allows a closer look at the plotted data around a given marker.

Limits - for the Histogram and Time Variation graphs, upper and lower limit lines can be set by entering the limit values via the Math screen.

Events - for the Time Variation and Events Timing graphs, the number of trigger events that occurred between two points on the graph can be displayed. This is useful in determining how many "missed" events (trigger events that were counted, but not timed) occurred during, or between, measurements.

Graphics Memory - any graph can be stored for later display and comparison to a newly taken graph. Both graphs may be displayed at the same time, with the stored graph being shown in half brightness. One graph at a time may be stored, and only the graphic image is stored, not the values, markers or limits.

Hard Copies - a hard copy of any graph (or any screen) can be generated via the Print/Plotter key. This will output the current screen directly to any HP-IB graphics printer. Graphic displays may be output to any HP-IB HP-GL plotter. A controller is not required for the printer or the plotter.

Time Variation Graph Specifics

The Time Variation graph can plot 125 measurements at one time. To plot a block of up to a 1000 measurements, the measurements are compressed into the available 125 points and then an average is plotted. The actual measurements are still shown however, as dots clustered around the average line. These dots provide an indication for the distribution of the actual measurements. As you zoom in, eventually the dots will not be needed. The plot line connects every actual measurement. The marker will always read whatever the plot line represents (average or actual) at that particular zoom level.

Since "back-to-back" measurements, like frequency, are usually an average of what happened during the sample interval, the Time Variation graph (when fully zoomed in) plots these measurement values as a horizontal line over the sample interval. For "individual" and non-continuous measurements, the horizontal line length is a combination of the "dead time" preceding the measurement and the measurement itself. The right hand edge of each horizontal line marks the end of the actual measurement. Thus, a marker will always read the measurement to its left (*Figure 18*).

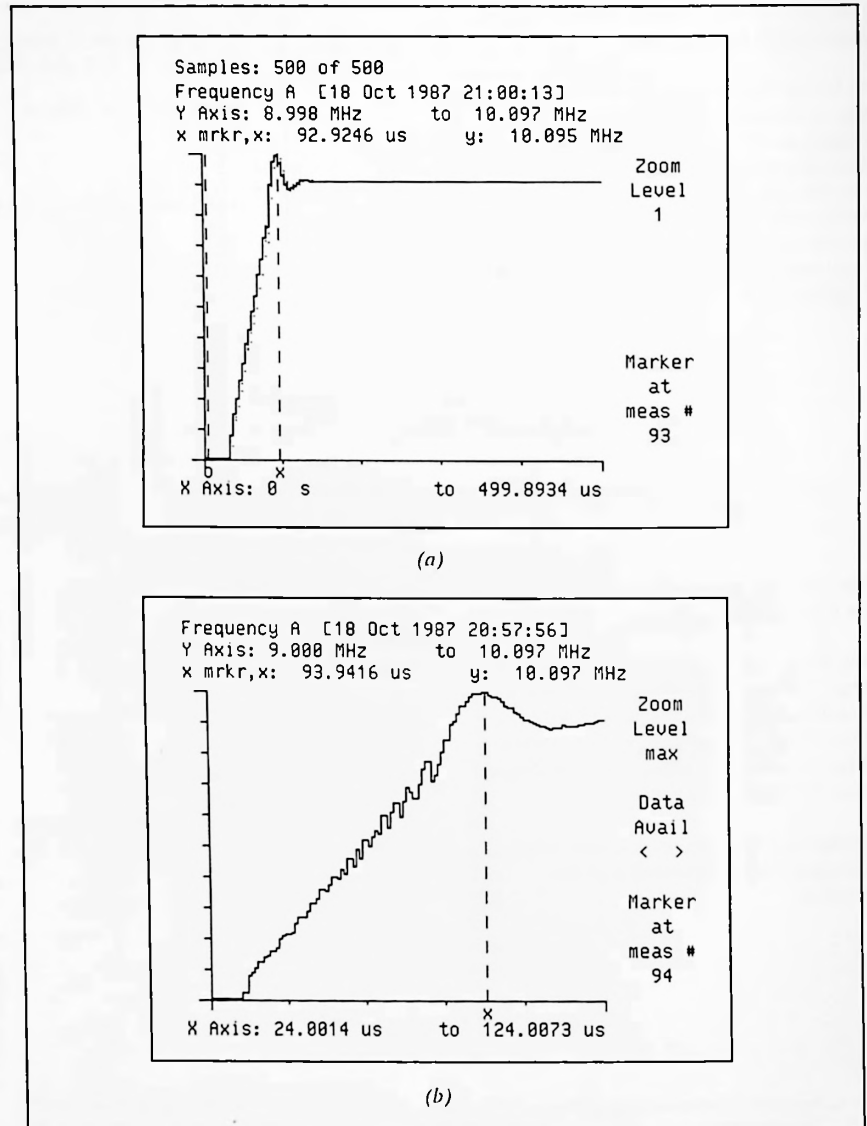

Figure 18. (a). A time variation plot of a VCO transient, (b) when "zoomed in", the dots are no longer needed since all results are connected with a line.



Histogram Graph Specifics

The Histogram's X-axis is automatically determined by taking the accumulated measurement's minimum and maximum values and dividing the difference into 1000 "bins" (5, 25, 125, 250, and 500 bins may also be used). Each bin then has a value range associated with it and all measurements that fall within this range are added to the bin count. The graph can display 125 bins at one time. In order to display the entire Histogram, adjacent bins are combined together. Thus the Zoom feature will continue to "zoom in" until the individual bins are shown.

The markers will read the bin's upper range value and bin count. They can also be used to specify a portion of the histogram for statistical analysis. The statistics performed are mean, minimum, maximum, and standard deviation. These statistics are based on the bin resolution (*Figure 19*).

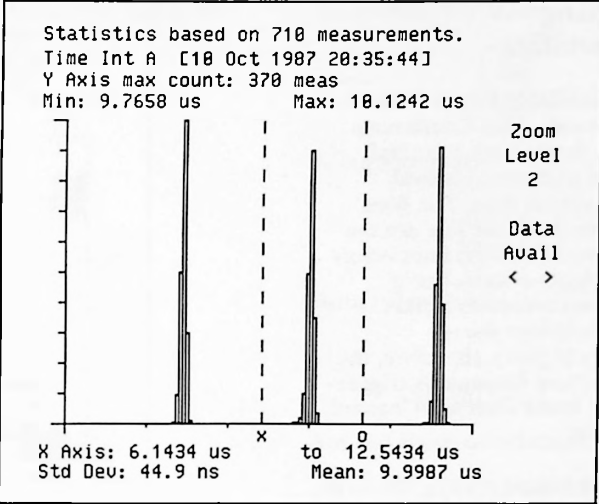

Figure 19. The results of a histogram are used to view a pulse stream which contains several different pulse widths. Here we have "zoomed in" to three pulse widths. Statistics, since calculated for the data between the cursors, can be for any single pulse's timing distribution.

Event Timing Graph Specifics

This graph is available for all "individual" measurements, plus Continuous Time Interval. It plots the start and stop points for each time interval measurement versus time. The lines above the horizontal time line are the start trigger-events and the lines below are the stop trigger-events. For \pm Time Interval measurements, this convention would lose the measurement's polarity, therefore, the upper lines become Channel A trigger-events and the lower lines are Channel B trigger-events.

Of course, only trigger events that have an associated time sample can be plotted, thus trigger events that were intentionally skipped through arming, or have violated the 200 ns spacing requirement, are not shown. The number of these "missed" events can be determined with the Events feature.

The Zoom feature is very useful for this graph as a block of 1000 measurements will first appear as a solid line. As you zoom in, the individual points will resolve themselves. Zooming can be continued until approximately 25 start/stop points are shown. At this point, delta marker measurements will carry the full resolution to which the measurements were made (Figure 20).

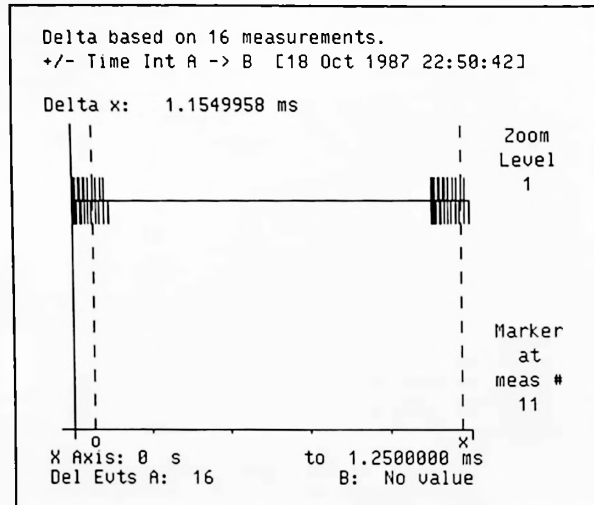

Figure 20. Here, the event timing mode is used to measure the time and number of events between selected pulses within two different pulse bursts. Here we see that 16 events occurred on the A Channel between the markers and the marked events occurred 1.1549958 ms apart.

Statistics

Statistics can be taken after each block, or cumulatively, over the entire set of blocks made during a measurement session. This allows you to statistically analyze up to 2 billion measurements at one time (Figure 21).

The statistics available are Mean, Minimum, Maximum, Variance, Standard Deviation, Root Mean Squared (RMS), Allan variance, and Root Allan variance (also commonly called $\sigma(\tau)$ or the nonnormalized Allan variance).

The results achieved are as follows:

Mean:

$$\frac{\sum x_i}{N}$$

Variance:

$$\frac{\sum x_i^2 - (\sum x_i)^2}{N-1}$$

Standard Deviation:

$$\sqrt{\frac{\sum x_i^2 - (\sum x_i)^2}{N-1}}$$

Root Mean Squared:

$$\sqrt{\frac{\sum(x_i)^2}{N}}$$

Allan Variance:

$$\frac{\sum(x_i - x_{i-1})^2}{2(N-1)}$$

Root Allan Variance:

$$\sqrt{\frac{\sum(x_i - x_{i-1})^2}{2(N-1)}}$$

For the above calculations:

- x_i = an individual measurement
- N = the number of measurements
- All summations except Allan variance are for $i = 1$ to N
- For Allan variance $i = 2$ to N

The calculated Allan Variance values in the HP 5371A are not normalized by the measured frequency. A commonly used version of Allan Variance is fractional frequency deviation $\sigma_y(\tau)$.

To convert the HP 5371A non-normalized values to $\sigma_y(\tau)$, divide the Root Allan Variance number (derived from a FREQUENCY measurement) by the nominal frequency being measured. This may be accomplished by using the NORMALIZE function under the MATH menu before the measurement is started. (See pg. 51).

For more information about the Allan Variance calculation and its application, refer to NBS Technical Note #669, "The Measurement of Frequency and Frequency Stability of Precision Oscillator", May 1975 by D.W. Allan.

STATISTICS DISPLAY	
Frequency A	24 Feb 1987 04:51:42
Block # 1	1000 Measurements
Mean	31.569 724 363 046 MHz
Std Dev	276.71 Hz
Maximum	31.570 136 0 MHz
Minimum	31.569 069 7 MHz
RMS	31.569 629 04 MHz
Rt Al Var	19.92 Hz
Allan Var	396.641 4 Hz ²
Variance	76.569 547 4 kHz ²

Figure 21. Shown above are the results of a statistical analysis in numerical format.

Table of Contents

	Page
II. Specification Guide	
Input Specifications	29
Measurement Mode Specifications	37
Arming, Gating and "Triggering" Characteristics	47
Math, Statistics, and Analysis Features	51
Memory	56
Rear Panel Specifications	57
HP-IB Characteristics	59
Time Base Specifications	64
General Specifications	65
Appendix	69

All data and specifications subject to change.

Input Specifications

Channel A and B:

All frequencies refer to sinusoidal signals, except where noted.

INPUT PODS

The following specifications refer to pods installed in an HP 5371A system.

	HP 54002A	HP 54001A	HP 54003A with 10:1 probe	HP 54003A without 10:1 probe
Coupling	dc	dc	dc	dc
Input Capacitance (NOMINAL)	N/A	2 pf	8 pf	10 pf
Input Resistance (NOMINAL)	50 Ω	10 k Ω	1 M Ω	1 M Ω
Bandwidth (-3dB)	dc to 500 MHz	dc to 500 MHz	dc to 300 MHz	dc to 300 MHz
Maximum Input Voltage X 1: X 2.5:	$\pm 2V$ $\pm 5V$	$\pm 20V$ N/A	$\pm 20V$ N/A	$\pm 2V$ N/A

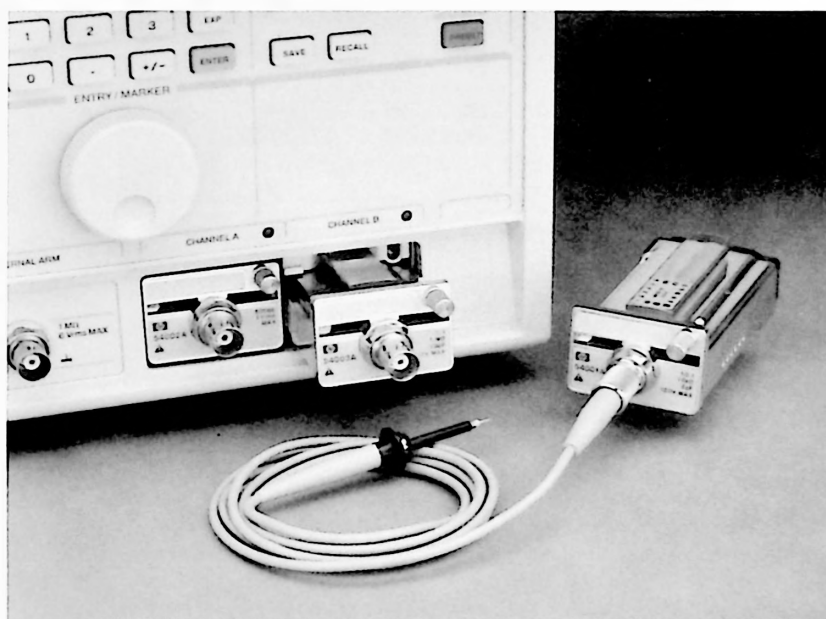

The HP 5371A offers a choice of three input pods: the HP 54001A 10K Ω active pod/probe, the HP 54002A 50 Ω pod (standard), and the HP 54003A 1M Ω pod.

The following specifications refer to an HP 5371A with HP 54002A pods installed.

RANGE:

dc coupled to 500 MHz.

SENSITIVITY:

Independent of SEPARATE or COMMON Input Mode selection.

15 mV rms sine wave (45 mV_{pk-pk}).

45 mV_{pk-pk} at a minimum pulse width of 1 ns.

MINIMUM PULSE WIDTH:

For all measurement modes except Holdoff Arming: 1 ns (at a minimum amplitude of 45 mV_{pk-pk}).

Holdoff Arming modes: 1.5 ns (at a minimum amplitude of 45 mV_{pk-pk}).

ATTENUATOR:

X1 or X2.5, selectable, for 50Ω termination to ground (HP 54002A Input pod only).

X1 only for 50Ω termination to -2 Vdc (NOMINAL), or for HP 54001A and HP 54003A Input pods.

Time Int A:				
INPUT _____				
SEPARATE Input Channels				
Trigger Event:				
	Slope	Mode	Level	
Chan A:	POS	SGL AUTO	50 %	= 2 mV
Chan B:	POS	SGL AUTO	50 %	= 5 mV
Ext Arm Level	0 V			
	Channel A	Channel B		
Input Pod	HP 54002A	HP 54002A		
Impedance	50 ohm	50 ohm		
Bias Level	GND			
Attenuation	1:1	2.5:1		
Maximum Input	2 V peak	5 V peak		

The HP 5371A features 1:1 and 2.5:1 attenuation choices for the HP 54002A 50Ω pod.

ATTENUATOR ACCURACY:

X1: Direct connection.

X2.5: ± 5 %.

DYNAMIC RANGE:

X1: 45 mV_{pk-pk} to 2 V_{pk-pk}.

X2.5: 115 mV_{pk-pk} to 5 V_{pk-pk} NOMINAL.

SIGNAL OPERATING RANGE:

X1: $-2 \text{ Vdc} < \text{dc} \pm \text{ac pk} < +2 \text{ Vdc}$.

X2.5: $-5 \text{ Vdc} < \text{dc} \pm \text{ac pk} < +5 \text{ Vdc}$ NOMINAL.

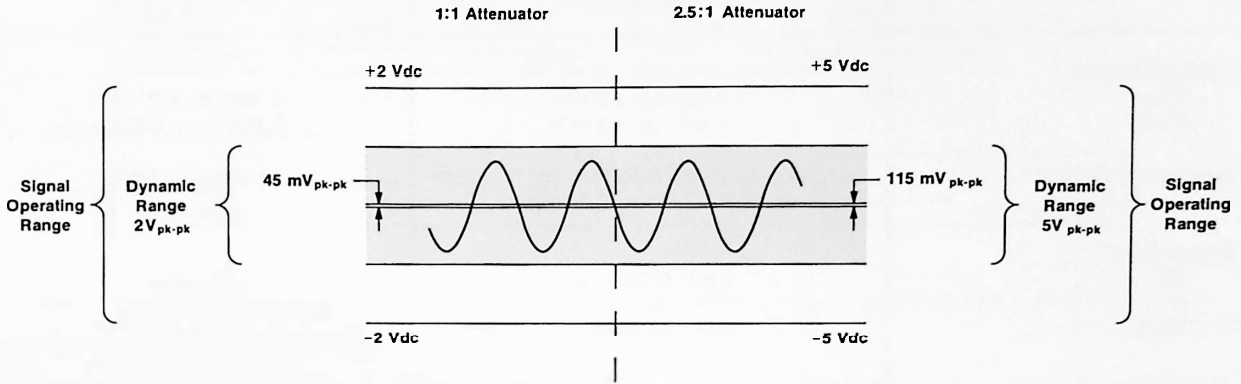

The input signal amplitude peaks must be within the shaded region of the diagram to match the dynamic range capabilities of the HP 5371A. The dynamic range "window" can be positioned anywhere within the limits of the signal operating range.

DAMAGE LEVEL:

X1: $\pm 2.5 \text{ V}$ (dc \pm ac pk).

X2.5: $\pm 5.5 \text{ V}$ (dc \pm ac pk).

Time Int A:		
INPUT _____		
SEPARATE Input Channels		
Trigger Event:		
	Slope	Mode
Chan A:	POS	SGL AUTO
Chan B:	POS	SGL AUTO
	Level	
	50 %	50 %
	=	2 mV
	=	5 mV
Ext Arm Level	0 V	
	Channel A	Channel B
Input Pod	HP 54002A	HP 54002A
Impedance	50 ohm	50 ohm
Bias Level	GND	GND
Attenuation	1:1	2.5:1
Maximum Input	2 V peak	5 V peak

The maximum input for 1:1 and 2.5:1 attenuation settings is 2V peak and 5V peak respectively.

INPUT TRIGGERING CHARACTERISTICS

	Manual Triggering	Auto Triggering (Single or Repetitive)
Voltage Range: X1: X2.5:	-2 Vdc to +2 Vdc -5 Vdc to +5 Vdc	-2 Vdc to +2 Vdc -5 Vdc to +5 Vdc
Frequency Range:	dc to 500 MHz (HP 54001A, HP 54002A) dc to 300 MHz (HP 54003A)	1 kHz to 200 MHz*
Resolution: X1: X2.5:	2 mV NOMINAL 5 mV NOMINAL	1% steps (2 mV minimum) 1% steps (5 mV minimum)
Accuracy:	20 mV \pm 1% of setting	\pm 20% of pk-pk amplitude (200 mV _{pk-pk} minimum)

* For input frequencies greater than 200 MHz, auto triggering modes are functional, but accuracy specifications are not guaranteed.

Auto trigger modes require a repetitive input signal and are available for input channels A and B.

AUTO TRIGGER MODES:

Time Int \bar{A} :

INPUT _____

SEPARATE Input Channels

Trigger Event:

	Slope	Mode	Level	
Chan A:	POS	MANUAL	0 V	
Chan B:	POS	SGL AUTO	50 %	= 5 mV

Ext Arm Level **0 V**

	Channel A	Channel B
Input Pod	HP 54002A	HP 54002A
Impedance	50 ohm	50 ohm
Bias Level	GND	GND
Attenuation	1:1	2.5:1
Maximum Input	2 V peak	5 V peak

The HP 5371A features three types of input triggering: manual, single auto trigger, and repetitive auto trigger.

SINGLE AUTO TRIGGER MODE:

The HP 5371A determines voltage trigger levels automatically at the beginning of the first block of measurements. These trigger levels are maintained for subsequent blocks in the measurement.

REPETITIVE AUTO TRIGGER MODE:

The HP 5371A determines voltage trigger levels at the beginning of each measurement block.

Single Auto Triggering

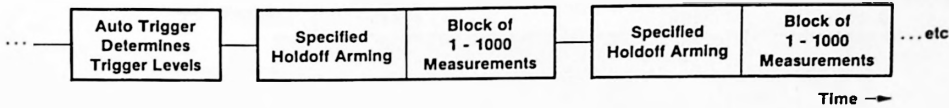

Repetitive Auto Triggering

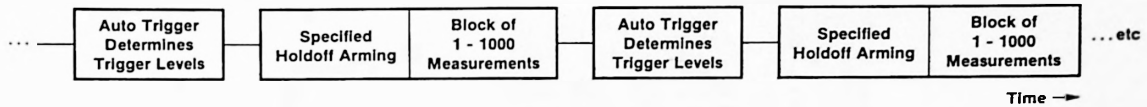

Single auto trigger determines trigger levels once, repetitive auto trigger determines the trigger levels prior to each measurement block.

AUTO TRIGGER ACQUISITION TIME:

100 msec (NOMINAL) per channel, 200 msec (NOMINAL) for two-channel measurements. Auto triggering will only be performed for channels which are currently selected as measurement sources on the FUNCTION menu.

TRIGGERING INDICATOR:

An LED for each respective input: A, B, and External Arm, will flash when a signal is triggering the input circuitry. The LED will not flash if the signal does not cross the trigger threshold.

TRIGGER LEVEL DRIFT:

Less than ± 10 mV (0 - 40°C).

RECOMMENDED INPUT CONFIGURATION FOR MEASURING TTL CIRCUITRY:

HP 54003A 1 M Ω input pod with matched 10:1 divider probe.

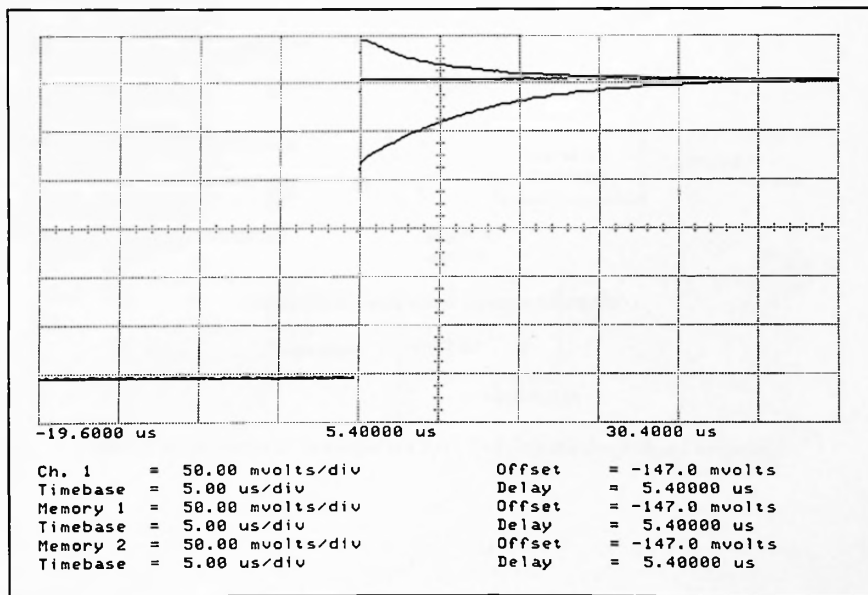

The HP 54003A 1 M Ω pod exhibits excellent flatness when used with its matched probe. This oscilloscope display shows the maximum excursions of the probe compensation, as well as a properly compensated probe for a step input.

RECOMMENDED INPUT CONFIGURATION FOR MEASURING ECL CIRCUITRY:

HP 54002A 50 Ω input pod using the -2 volt or ground input termination. (see the HP 5371A INPUT menu for the -2 volt selection.)

INPUT MODE SELECTION:

```

Time Int A:
INPUT _____
COMMON Input Channels [Chan A -> Chan A&B]

Trigger Event:
Slope Mode Level
Chan A: POS MANUAL 0 V
Chan B: POS SGL AUTO 50 % = 2 mV

Ext Arm Level 0 V

Channel A Channel B
Input Pod HP 54002A HP 54002A
Impedance 50 ohm 50 ohm
Bias Level GND GND
Attenuation 1:1 2.5:1
Maximum Input 2 V peak 5 V peak
    
```

A buffered common mode maintains circuit-under-test impedance for measurement integrity.

Separate: User-selectable and programmable. Each input channel A and B is connected directly to its respective input circuitry.

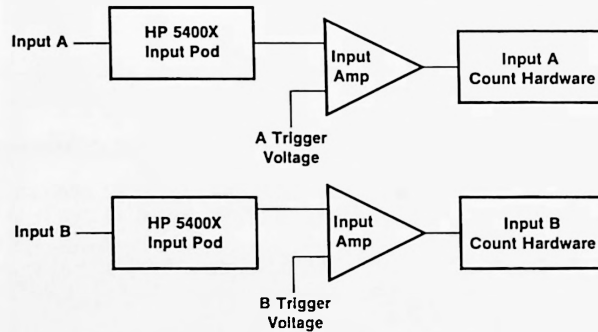

HP 5371A separate mode input configuration.

Common A: User-selectable and programmable. Input channel A signals are also routed to the input channel B count circuitry. Input channel B is terminated per the INPUT menu selection. Termination characteristics are maintained to the device under test, while signal amplitude is maintained to both input channels.

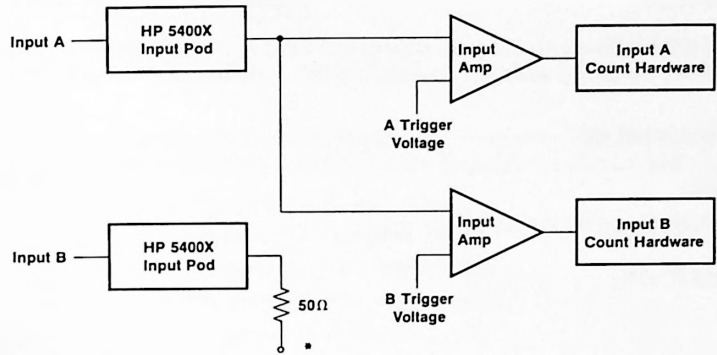

The HP 5371A common mode connects Channel A inputs to Channel B internally.

* Configuration is maintained from SEPARATE mode. For example, if the HP 54002A pod is used with -2V termination and 1:1 attenuation, this configuration will be maintained for COMMON A.

External Arm Input:

In addition to the External Arm input, both input channels A and B may also be used as high performance arming inputs.

RANGE:

dc coupled to 100 MHz.

SENSITIVITY:

50 mV rms sine wave.

140 mV_{pk-pk} at a minimum pulse width of 5 ns.

MINIMUM PULSE WIDTH:

5 ns (at a minimum amplitude of 140 mV_{pk-pk}).

IMPEDANCE:

1 MΩ NOMINAL, shunted by < 50 pf.

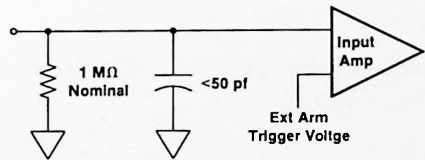

The HP 5371A External Arm input is a fixed 1 MΩ impedance (pods not available).

DYNAMIC RANGE:

50 mV_{pk-pk} to 5 V_{pk-pk}.

SIGNAL OPERATING RANGE:

-5 Vdc < dc ± ac pk < + 5 Vdc.

DAMAGE LEVEL:

5 V rms (± 15 V_{pk-pk}, dc ± peak ac).

TRIGGER LEVEL RANGE:

Adjustable from -5.00 Vdc to +5.00 Vdc in 20 mV steps.

TRIGGER LEVEL RESOLUTION:

20 mV NOMINAL.

TRIGGER LEVEL ACCURACY:

± 20 mV or ± 10% of trigger level setting, whichever is greater.

Measurement Mode Specifications

Continuous Frequency Measurements:

The minimum continuous sample interval is 100 ns (10 MHz sample rate) for single-channel measurements, and 200 ns (5 MHz sample rate) for two-channel measurements. Sample intervals less than 100 ns are available, but measurements will not be contiguous.

The HP 5371A offers one- and two-channel measurement features for frequency. The following single-result and dual-result arithmetic combinations of frequency measurements are available for display and analysis:

- Frequency A (single-result).
- Frequency B (single-result).
- Frequency A&B (dual-result).
- Frequency A + B (single-result).
- Frequency A-B (single-result).
- Frequency B-A (single-result).
- Frequency A/B (single-result).
- Frequency B/A (single-result).

Accuracy and resolution equations apply to both input channels.

Frequency measurements are acquired simultaneously for all two-channel measurements. Measurement throughput is dictated by the lower frequency input signal.

RANGE:

Frequency A,B: 125 mHz to 500 MHz.

Frequency A&B, A + B, A-B, B-A: 250 mHz to 500 MHz.

FOR A SINGLE MEASUREMENT:

LEAST SIGNIFICANT DIGIT DISPLAYED:

$$\pm \frac{200\text{ps}}{\text{Sample Interval}} \times \text{Frequency}$$

RESOLUTION:

$$\pm \frac{150\text{ps rms} + (1.4 \times \text{Trigger Error})}{\text{Sample Interval}} \times \text{Frequency}^\dagger$$

ACCURACY:

$$\pm \text{Resolution} \pm (\text{Time Base Aging} \times \text{Frequency})^\ddagger$$

† Refer to graph 1

‡ Refer to graph 2

FOR CONTINUOUS FREQUENCY MEASUREMENTS (MEAN ESTIMATION):

rms RESOLUTION (for Number of Measurements per block ≥3):

$$\frac{\sqrt{13.5} \times (150\text{ps rms} + 1.4 \times \text{Trigger Error})}{(\text{Number of Blocks})^{1/2} \times (\text{Number of Measurements per Block})^{3/2} \times \text{Sample Interval}} \times \text{Frequency}$$

ACCURACY:

$$\pm \text{Resolution} \pm (\text{Time Base Aging} \times \text{Frequency})^\ddagger$$

† Refer to graph 1
 ‡ Refer to graph 2

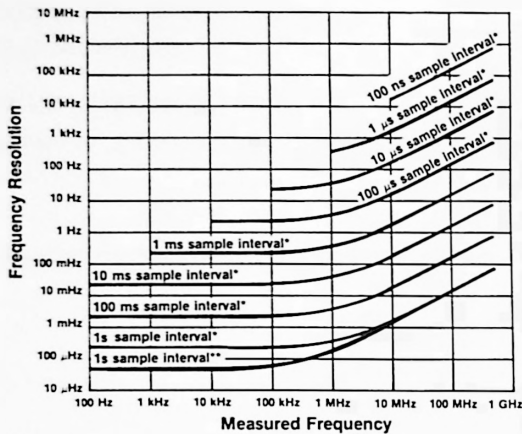

* 1 mV rms noise, 2 Vp-p sine wave
 ** 100 μV rms noise, 2 Vp-p sine wave

Graph 1. Noise on the input signal will add uncertainty to Frequency or Period measurement. Longer sample times and averaging will reduce the effects of random noise.

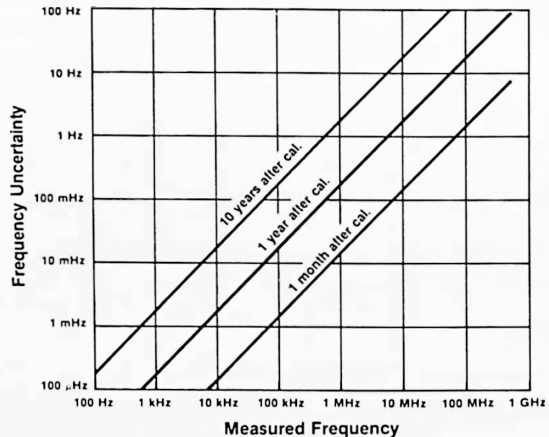

Graph 2. Timebase crystal aging affects Frequency and Period measurement accuracy. You can further reduce aging uncertainty by using an atomic standard.

Continuous Period Measurements:

The HP 5371A offers one- and two-channel period measurement features. The following single-result and dual-result arithmetic combinations of period measurements are available for display and analysis:

- Period A (single-result).
- Period B (single-result).
- Period A&B (dual-result).
- Period A + B (single-result).
- Period A-B (single-result).
- Period B-A (single-result).
- Period A/B (single-result).
- Period B/A (single-result).

Accuracy and resolution equations apply to both input channels.

Period measurements are acquired simultaneously for all two-channel measurements. Throughput is dictated by the lower frequency (larger period) input signal.

RANGE:

Period A,B: 2 ns to 8.0 seconds.

Period A&B, A + B, A-B, B-A: 2 ns to 4.0 seconds.

FOR A SINGLE MEASUREMENT:

LEAST SIGNIFICANT DIGIT DISPLAYED:

$$\pm \frac{200 \text{ ps}}{\text{Sample Interval}} \times \text{Period}$$

RESOLUTION:

$$\pm \frac{150 \text{ ps rms} + (1.4 \times \text{Trigger Error})}{\text{Sample Interval}} \times \text{Period}$$

ACCURACY:

$$\pm \text{Resolution} \pm (\text{Time Base Aging} \times \text{Period})$$

FOR CONTINUOUS PERIOD MEASUREMENTS (MEAN ESTIMATION):

rms RESOLUTION (for Number of Measurements per Block ≥ 3):

$$\frac{\sqrt{13.5} \times (150 \text{ ps rms} + 1.4 \times \text{Trigger Error})}{(\text{Number of Blocks})^{1/2} \times (\text{Number of Measurements per Block})^{3/2} \times \text{Sample Interval}} \times \text{Period}$$

ACCURACY:

$$\pm \text{Resolution} \pm (\text{Time Base Aging} \times \text{Period})$$

Frequency or Period Ratio Measurements A/B or B/A:

The following equations apply for frequency or period A/B and B/A measurements:

RANGE:

250 mHz to 500 MHz (2 ns to 4.0 seconds).

LEAST SIGNIFICANT DIGIT DISPLAYED:

$$\pm \frac{200 \text{ ps}}{\text{Sample Interval}}$$

RESOLUTION:

$$\pm \text{RATIO} \times \frac{150 \text{ ps rms} + (1.4 \times \text{Trigger Error})}{\text{Sample Interval}}$$

ACCURACY:

$$\pm \text{Resolution} \pm \frac{\text{Timebase Aging} \times \text{Frequency A}}{\text{Timebase Aging} \times \text{Frequency B}}$$

Totalize Measurements:

The HP 5371A offers one- and two-channel measurement features for totalize. The following single-result and dual-result arithmetic combinations of totalize measurements are available for display and analysis:

- Totalize A (single-result).
- Totalize B (single-result).
- Totalize A&B (dual-result).
- Totalize A + B (single-result).
- Totalize A-B (single-result).
- Totalize B-A (single-result).
- Totalize A/B (single-result).
- Totalize B/A (single-result).

Accuracy and resolution equations apply to both input channels.

Totalize measurements are acquired simultaneously for all two-channel measurements.

RANGE:

0 to 4×10^9 events per measurement sample, for each channel.

LEAST SIGNIFICANT DIGIT DISPLAYED:

1 count of input per measurement sample, for each channel.

RESOLUTION:

± 1 count of input per measurement sample, for each channel.

For A/B, B/A:

$$\pm \frac{(\text{Totalize Result A} \pm 1)}{(\text{Totalize Result B} \mp 1)}$$

ACCURACY:

± 1 count of input per measurement sample, for each channel.

For A/B, B/A:

$$\pm \frac{(\text{Totalize Result A} \pm 1)}{(\text{Totalize Result B} \mp 1)}$$

Time Interval Measurements:

The HP 5371A is capable of measuring consecutive time intervals up to a 10 MHz rate for period type interval measurements (Continuous Time Interval A or B), and 5 MHz for two channel measurements such as Time Interval A→B.

If data rates exceed these values, the number of events which do not have timing information are noted on the NUMERIC display in the EXPANDED results display.

RESULT DISPLAY		Meas Size = 6
Time Interval A		01 Jan 1987 00:34:04
Block # 1		6 Measurements
View Meas #	1	
Meas#	Measurement/Missed Events	
0001 Meas		78.4 ns
Event		2
0002 Meas		78.4 ns
Event		2
0003 Meas		78.4 ns
Event		2
0004 Meas		78.4 ns
Event		2
0005 Meas		78.4 ns
Event		2
0006 Meas		78.4 ns

The HP 5371A Numeric display shows the number of intermediate events between time samples, if any occur.

The following Time Interval measurement configurations are available:

- Time Interval, ± Time Interval, Continuous Time Interval A (single-result).
- Time Interval, ± Time Interval, Continuous Time Interval B (single-result).
- Time Interval and ± Time Interval A→B (single-result).
- Time Interval and ± Time Interval B→A (single-result).

RANGE:

Time Interval: 10 ns to 8.0 seconds

Continuous Time Interval: 100 ns to 8.0 seconds

±Time Interval: - 4.0 seconds to + 4.0 seconds, including 0 seconds.

LEAST SIGNIFICANT DIGIT DISPLAYED:

N = number of measurements averaged.

$$\pm \frac{200 \text{ ps}}{\sqrt{N}}$$

RESOLUTION:

$$\pm \frac{150 \text{ ps rms} \pm \text{Start Trigger Error}^\dagger \pm \text{Stop Trigger Error}^\dagger}{\sqrt{N}}$$

ACCURACY:

$$\pm \text{RESOLUTION} \pm (\text{Time Base Aging} \times \text{Time Interval}^{\dagger\dagger}) \pm \text{Trigger Level Timing Error}^{\ddagger} \pm 1 \text{ ns Systematic Error}^*$$

† Refer to Graph #3.

†† Refer to Graph #4.

‡ Refer to Graph #5.

- Systematic error can be reduced to less than 10 ps with the HP J06-59992A Time Interval Calibrator.

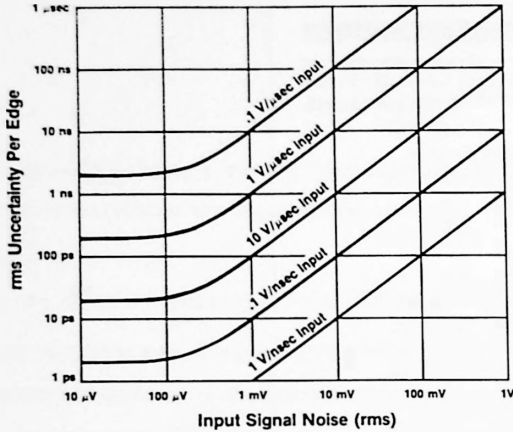

Graph 3. Noise on the input signal will add uncertainty to time interval measurements. Averaging will reduce the effects of random noise.

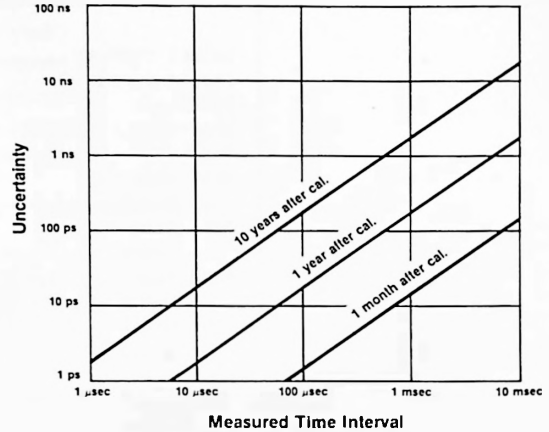

Graph 4. Timebase crystal aging affects time interval measurements.

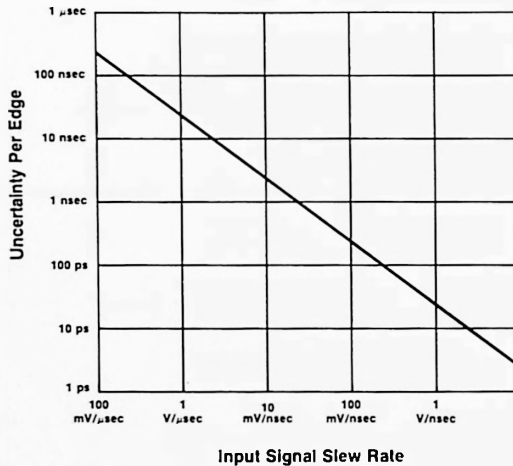

Graph 5. Trigger level timing error varies with input signal slew rate. Uncertainty is associated with both start and stop edges. Trigger level timing error is zero for Continuous Time Interval A, B, Time Interval A, and Time Interval B.

Rise Time A and Fall Time A:

Common A and Repetitive Auto Trigger are automatically enabled for these measurements. Trigger points are defaulted to the 20% and 80% points of the peak-to-peak amplitude for rise time (or 80% and 20% for fall time). All trigger values are NOMINAL. Other trigger values may be selected from the INPUT menu.

Rise time and fall time measurements are two-channel, single-result measurements.

RANGE:

1 ns to 100 μ s transitions (auto trigger).

REPETITION RATE:

\leq 111 MHz (1 kHz minimum when using auto trigger modes).

MINIMUM PULSE HEIGHT (X1 Attenuation):

200 mV_{pk-pk} (auto trigger).

LEAST SIGNIFICANT DIGIT DISPLAYED:

N = number of measurements averaged.

$$\pm \frac{200 \text{ ps}}{\sqrt{N}}$$

RESOLUTION:

$$\pm \frac{150 \text{ ps rms} \pm \text{Start Trigger Error} \pm \text{Stop Trigger Error}}{\sqrt{N}}$$

ACCURACY:

\pm RESOLUTION \pm (Time Base Aging \times Rise Time) \pm Trigger Level Timing Error \pm 1 ns Systematic Error

Positive and Negative Pulse Width A:

Common A and Repetitive Auto-Trigger are automatically enabled for these measurements. Trigger points are defaulted to the 50% (NOMINAL) point of the peak-to-peak amplitude. Trigger levels can then be varied on the INPUT menu if desired.

Positive and negative pulse width measurements are two-channel, single-result measurements.

RANGE:

1 ns to 1 ms pulse width (auto trigger).

REPETITION RATE:

A delay of \geq 8 ns is required between each pulse. For example, a positive pulsewidth measurement of 2 ns can be measured to a repetition rate of 100 MHz ($= \frac{1}{2 \text{ ns} + 8 \text{ ns}}$). 1 kHz minimum when using auto trigger modes.

MINIMUM PULSE HEIGHT (X1 Attenuation):

200 mV_{pk-pk} (auto trigger).

LEAST SIGNIFICANT DIGIT DISPLAYED:

N = number of measurements averaged.

$$\pm \frac{200 \text{ ps}}{\sqrt{N}}$$

RESOLUTION:

$$\pm \frac{150 \text{ ps rms} \pm \text{Start Trigger Error} \pm \text{Stop Trigger Error}}{\sqrt{N}}$$

ACCURACY:

$$\pm \text{RESOLUTION} \pm (\text{Time Base Aging} \times \text{Pulse Width}) \pm \text{Trigger Level Timing error} \pm 1 \text{ ns Systematic Error}^*$$

* Systematic error can be significantly reduced with the HP J06-59992A Time Interval Calibrator.

Duty Cycle A:

Common A and Repetitive Auto Trigger are automatically enabled for these measurements. Trigger points are defaulted to the 50% (NOMINAL) point of the peak-to-peak amplitude. Trigger levels can then be varied on the INPUT menu if desired.

Duty cycle A consists of simultaneous positive pulse width and period measurements on input channel A. Duty cycle A measurements are made continuously, or consecutively to a maximum rate of 5 MHz.

Duty cycle A is a two-channel, single-result measurement.

RANGE:

0% to 100% (provided pulse width is > 1 ns, and signal period is < 4.0 seconds).

REPETITION RATE:

A delay of ≥ 8 ns is required between each pulse. For example, for a 1 ns positive pulse, the repetition rate must be ≤ 111 MHz ($= \frac{1}{1 \text{ ns} + 8 \text{ ns}}$), for a 11% duty cycle. 1 kHz minimum repetition rate for auto trigger modes.

MINIMUM PULSE HEIGHT (X1 Attenuation):

200 mV_{pk-pk} (auto trigger).

LEAST SIGNIFICANT DIGIT DISPLAYED:

$$\pm \frac{200 \text{ ps}}{\text{Period}} \times 100\%$$

RESOLUTION:

$$\pm \text{DUTY CYCLE} \times \left(150 \text{ ps rms} \pm (1.4 \times \text{Trigger Error}) \right) \times \sqrt{\frac{1}{(t_2 - t_1)^2} + \frac{1}{(t_3 - t_1)^2}}$$

where t_1 , t_2 , and t_3 are time “samples”, and e_1 , e_2 , and e_3 are event “samples”.

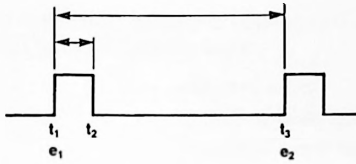

$$\text{Duty Cycle} = \frac{(t_2 - t_1)}{(t_3 - t_1)} \times (e_2 - e_1) \times 100\%$$

ACCURACY:

$$\pm \text{Resolution} \pm \frac{(\text{Trigger Level Timing Error} \pm 1 \text{ ns})}{\text{Period}} \times 100\%$$

Phase A-relative-to-B, Phase B-relative-to-A:

Repetitive Auto Trigger is automatically enabled for this measurement. Trigger points are defaulted to the 50% (NOMINAL) point of the peak-to-peak amplitude for both input channels A and B. Trigger levels can then be varied on the INPUT menu if desired.

Phase measurements are made continuously, or back-to-back, up to a rate of 5 MHz. Phase measurements are two-channel, single-result measurements.

RANGE:

Phase deviations can be measured in excess of $\pm 360^\circ$. Results are not adjusted modulo 360° , therefore phase shifts greater than 360° will be measured and displayed. The input signal's period must be less than 4 seconds (minimum frequency: 250 mHz).

LEAST SIGNIFICANT DIGIT DISPLAYED:

$$\pm \frac{200 \text{ ps}}{\text{Period}} \times 360^\circ$$

RESOLUTION: A relative to B (B relative to A)

$$\pm \text{PHASE} \times \left(150 \text{ ps rms} \pm (1.4 \times \text{Trigger Error}) \right) \times \sqrt{\frac{1}{(t_2 - t_1)^2} + \frac{1}{(t_3 - t_1)^2}}$$

where t_1 , t_2 , and t_3 are time “samples” and e_1 , e_2 , and e_3 are event “samples”.

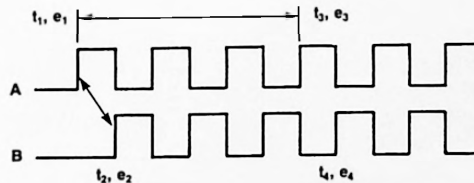

Phase B relative to A

$$\text{Phase} = \left[\frac{(t_2 - t_1)}{(t_3 - t_1)} \times (e_3 - e_1) + ((e_3 - e_1) - (e_4 - e_2)) \right] \times 360^\circ$$

ACCURACY: (A relative to B) (B relative to A)

$$\pm \text{Resolution} \pm \left(\frac{\text{Trigger Level Timing Error} \pm 1 \text{ ns}}{\text{Period}} \right) \times 360^\circ$$

Peak Amplitudes A,B:

FREQUENCY RANGE:

1 kHz to 200 MHz.

AMPLITUDE RANGE:

200 mV_{pk-pk} to 2V_{pk-pk} (X1 Attenuation).

RESOLUTION:

X1: 2 mV NOMINAL.

X2.5: 5 mV NOMINAL.

ACCURACY:

± 20% of peak-to-peak amplitude, 1 kHz to 200 MHz.

Note: The peak amplitude measurement mode is operational for frequencies between 200 MHz and 500 MHz, but accuracy is not guaranteed.

Arming, Gating and "Triggering" Characteristics

The HP 5371A features extensive arming and triggering capabilities. These capabilities allow you to control measurements in the following ways:

- external edge
- specified time holdoff or gate
- specified event holdoff or gate
- specified number of cycles of the input or the internal time base
- parity
- manual

Input channels A, B or External Arm may be used to arm the HP 5371A. Input channels A and B offer higher performance (500 MHz bandwidth) versus the External Arm channel (100 MHz).

Time or event delays are relative to a specified edge on any of the three input channels.

For certain arming modes, a 2 ns resolution time holdoff or gate time is available. This high resolution time sampling mode is called "TIME". For other time sampling modes, a lower resolution mode is used. This type of time sampling is termed "INTERVAL". INTERVAL sampling can be used for continuous measurements, while the 2 ns resolution TIME sampling is only available for non-continuous measurements.

AUTOMATIC Arming and Sampling:

The particular hardware configuration for this arming mode is defaulted to the fastest mode possible for the particular function. Each measurement begins as soon as the HP 5371A internal processor has configured the measurement.

EDGE Holdoff and Sampling:

Holdoff and sampling can be armed or "triggered" with a signal edge on input channels A, B, or External Arm. The slope of this edge is specified on the FUNCTION menu, while the trigger voltage is specified on the INPUT menu.

EDGE ARMING SETUP TIME:	SETUP TIME
External Arm arms Channel A:	< 15 ns
Channel B arms Channel A:	< 8 ns
Channel A arms Channel B:	< 8 ns
Channel A arms Channel A:	< 5 ns
Channel B arms Channel B:	< 5 ns

EVENT Arming and Gating:

Event holdoffs and gating are counted on the Input A or Input B channel. All event holdoffs and gates are referenced to an input signal edge on Channel A, B, or External Arm.

RANGE:

0 to 4×10^9 . If 0 is specified, the arming defaults to the edge arming mode.

RESOLUTION:

± 1 count of input signal.

EVENT ARMING SETUP TIME:

Upon the completion of the event holdoff, a setup time of < 25 ns is required before the measurement is armed.

TIME Arming and Gating:

The Time holdoff is referenced to an input signal edge on input channels A, B, or External Arm.

RANGE:

2 ns to 8.0 seconds.

RESOLUTION:

2 ns.

ACCURACY:

± 2 ns + (Systematic uncertainty < 25 ns).

TIME ARMING SETUP TIME:

Upon the completion of the time holdoff, a setup time of < 25 ns is required before the measurement becomes armed.

INTERVAL Sampling:

RANGE:

600 ns to 8.0 seconds.

RESOLUTION:

600 ns to 10 ms : 200 ns

10 ms to 100 ms : $2 \mu\text{s}$

100 ms to 1 second : $20 \mu\text{s}$

1 second to 8.0 second : $200 \mu\text{s}$

Note that this refers to the "settability" of the sample interval. Actual measurement intervals are displayed with 200 ps LSD. In addition, the HP 5371A uses a reciprocal counting technique which synchronizes measurements to the input signal. Therefore, actual measurement gates will vary depending on the relative synchronization of the input signal.

SETUP DELAY:

The first INTERVAL will begin < 800 ns after the HP 5371A is armed.

CYCLE Sampling:

The CYCLE sampling mode uses prescaled counts of an input signal on channel A or B, or the internal 500 MHz timebase to arm measurement samples. CYCLE sampling on an input channel offers essentially a continuous EVENT sampling mode, while using the CYCLE mode with the 500 MHz timebase offers a high precision continuous time sampling mode. Each prescale value has a minimum specified input frequency at which it can be used. The available prescale ratios and the associated minimum operating frequencies are listed below:

<i>Cycles</i>	<i>Minimum Cycle Input Frequency</i>
2^{28} (268,435,456)	33,554,432 Hz
2^{24} (16,777,216)	2,097,152 Hz
2^{20} (1,048,576)	131,072 Hz
2^{16} (65,536)	8,192 Hz
2^{12} (4,096)	512 Hz
2^8 (256)	32 Hz
2^4 (16)	2 Hz

The 2^4 prescale factor is not recommended for input frequencies above 160 MHz, as it results in non-continuous measurements.

RESOLUTION:

2ns, or 1 edge of input.

PARITY Sampling:

Parity is a sample arming condition that arms a measurement after a signal edge on both input channels A and B has been detected. This mode is useful when measuring time intervals between edges that lead and follow one another randomly.

The parity sampling mode is available for \pm Time Interval A \rightarrow B and B \rightarrow A measurements only.

PARITY MODE FREQUENCY RANGE:

Parity sampling is available for input signal frequencies from 125 mHz to 100 MHz.

EXTERNALLY GATED Sampling:

The frequency, period, or totalize sampling interval can be controlled by the leading and trailing edges of an external pulse on input channels A, B, or External Arm.

GATE WIDTH RANGE:

10 ns to 8.0 seconds.

SETUP DELAY:

30 ns TYPICAL.

AMPLITUDE:

The gating signal must meet dynamic range specifications for the input channel.

When using the EXTERNAL GATE mode with the TOTALIZE function, the maximum repetition rate of the external gating signal is 2.5 MHz.

MANUAL Sampling:

For TOTALIZE measurements the sampling of the totalize count occurs when the front panel MANUAL ARM key is pressed, or when the HP-IB commands GET (Group Execute Trigger) or *TRG (Trigger) are received.

Math, Statistics, and Analysis Features

Math:

Computations can be automatically performed on each measurement result in order to scale results to appropriate values. Separate math values are available for input channels A and B. Other instrument functions such as statistics, limit checking, and graphics are performed on this processed data.

Time Int A:		
MATH	_____	
	Channel A	Channel B
Reference	0E+00	0E+00
Statistics	OFF	OFF
Math:	ON	OFF
Offset	987.2500000E+00	
Normlz	1.256980000E+00	
Scale	2.963000000E-00	
Limits:	OFF	OFF
Display = [((Result-Ref)/Norm)+Offs]*Scale		

Math features include Normalize, Scale, Offset, and Set Reference for both input channels A and B.

The math functions are applied in the following manner:

$$\text{Math Result} = \left[\frac{\text{MEASUREMENT RESULT} - \text{Reference}}{\text{Normalize}} + \text{Offset} \right] \times \text{Scale}$$

NORMALIZE:

Raw measurement results, less the reference value, are divided by the NORMALIZE value. This value may not be 0.

Negative Range: $-1 \times 10^{12} < \text{NORMALIZE value} < -1 \times 10^{-12}$.

Positive Range: $1 \times 10^{-12} < \text{NORMALIZE value} < 1 \times 10^{12}$.

Resolution: 10 digits.

Default value: 1.

OFFSET:

The OFFSET value is added to the normalized result.

Negative Range: $-1 \times 10^{12} < \text{OFFSET value} < -1 \times 10^{-12}$.

Positive Range: $1 \times 10^{-12} < \text{OFFSET value} < 1 \times 10^{12}$, and 0.

Resolution: 10 digits.

Default value: 0.

SCALE:

After normalize and offset processing, the result will be multiplied by the SCALE value.

Negative Range: $-1 \times 10^{12} < \text{SCALE value} < -1 \times 10^{-12}$.

Positive Range: $1 \times 10^{-12} < \text{SCALE value} < 1 \times 10^{12}$, and 0.

Resolution: 10 digits.

Default value: 1.

SET REFERENCE:

Set Reference is a constant value subtracted from each measurement result. The subtraction operation is performed before other math operations. Set Reference differs from the Offset value in that it is entered as the mean of the last sample set if statistics are enabled, or the last measurement value if statistics are disabled. The Set Reference value cannot be entered directly from the numeric keypad. Separate reference values are available for input channels A and B. Clear Reference sets the reference value to 0.

Default value: 0

LIMIT TEST:

Upper and lower limit values may be specified for each input channel A and B. Limit comparison is performed after the measurement block has been acquired. Measurements falling outside of the user-defined limits will be indicated on a numeric display. In addition, a bit will be set in the HP-IB status register, indicating an out-of-limit occurrence. Limit values are also denoted on the Time Variation and Histogram displays.

Frequency A:		
MATH	Channel A	Channel B
Reference	0E+00	0E+00
Statistics	<input type="checkbox"/> OFF	<input type="checkbox"/> OFF
Math:	<input type="checkbox"/> OFF	<input type="checkbox"/> OFF
Limits:	<input checked="" type="checkbox"/> ON	<input type="checkbox"/> OFF
High	4.250000000E+06	
Low	3.950000000E+06	

Limit test values can be applied to both input channels A and B.

Negative Range: $-1 \times 10^{12} < \text{LIMIT value} < -1 \times 10^{-12}$.

Positive Range: $1 \times 10^{-12} < \text{LIMIT value} < 1 \times 10^{12}$, and 0.

Resolution: 1×10^{-12} .

Statistics:

The following statistical values are available on a HP 5371A numeric display:

Mean

Minimum Value

Maximum Value

Variance

Standard Deviation

rms (Root Mean Square)

Allan Variance

Root Allan Variance (square root of the Allan Variance calculation).

Measurement sample sizes to 2 billion measurements are available (2 million, 1000 measurement blocks).

Sample Period = 1.000000 ms	
STATISTICS DISPLAY	
Frequency A	01 Jan 1987 03:21:52 1000 Measurements
Mean	10.001 751 3 MHz
Std Dev	114.9 Hz
Maximum	10.001 968 MHz
Minimum	10.001 432 MHz
RMS	10.001 966 1 MHz
Rt Al Var	46.9 Hz
Allan Var	2.201 8 kHz ²
Variance	13.210 4 kHz ²

The HP 5371A offers a complete set of statistical computations.

In addition, statistics on subsets of measurement data can be computed on the Histogram display. These statistics are: Mean, Minimum, Maximum, and Standard Deviation.

Graphic Analysis:

HISTOGRAM

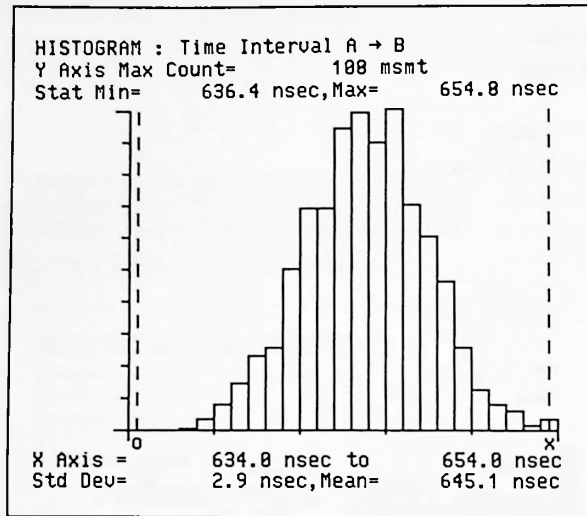

Histograms can be displayed on the HP 5371A CRT. Marker and zoom features enhance the analysis flexibility of this display.

Histograms, or probability density distributions, can be displayed for all measurement types. The user can define minimum and maximum limits for the histogram, or an auto-scaling feature can be used to scale the bin values. Linear or logarithmic scaling may be selected for the vertical axis. Measurements are acquired in blocks of up to 1000 measurements. Larger sample sizes may be obtained by specifying multiple blocks of measurements. The histogram can then be made to "grow" (accumulate) with each new block of data. Specific measurements are retained for the most recent measurement block.

```
Frequency A:

GRAPH FORMAT _____
HISTOGRAM Graph Configuration:

Measurement / X-Axis:
Auto Scale OFF
Data Bins 1000
Maximum Value 101.0000000E+06
Minimum Value 99.0000000E+06
Bin Resolution = 2.01 kHz

Event / Y-Axis:
Auto Scale ON
Scale Type LINEAR
```

In addition to automatic scaling, the user may invoke manual scaling for any of the three graphical displays.

The minimum and maximum values, as well as the number of bins may be defined by the user. The following number of bins are available: 5, 25, 125, 250, 500, and 1000.

TIME VARIATION

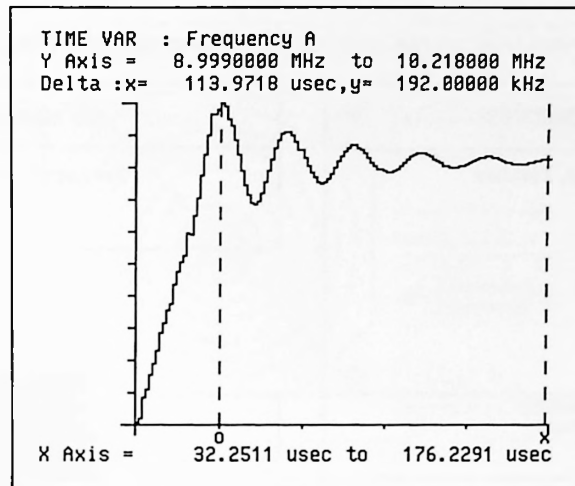

This HP 5371A Time Variation display shows how a VCO frequency varies with time as a voltage step is applied to its input.

The Time Variation plot displays measurement values versus their time of occurrence. Measurement sizes up to 1000 measurements may be acquired and displayed.

The time variation display shows up to 125 separate values. These data points are connected by a line. For displays greater than 125 measurements, each measurement is depicted by a dot, while a line shows an average of measurement values. The "zoom" feature can then be used to magnify the display until 125 measurements are displayed on the screen. The dot is placed at the time of the completion of the measurement.

EVENT TIMING

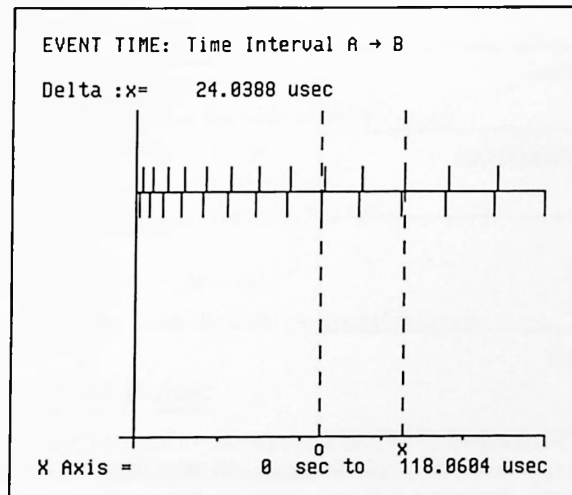

The Event Timing plot depicts the power of continuous measurements by giving timing information between any two measurement time stamps.

The Event Timing graph depicts the starting and ending time of each time interval measurement. Start values are denoted with an upward tick mark while stop values are denoted with a downward tick mark. Up to 250 start and 250 stop points can be displayed separately on this graph. Measurement sizes up to 1000 measurements can be analyzed with this graph.

Memory

The HP 5371A queues measurements in an internal memory. The memory size (block size) is as follows:

1000 MEASUREMENTS
Frequency, Period, Totalize A B A+B A-B B-A A/B B/A
Time Interval A B A-B B-A
± Time Interval A B A-B B-A
Continuous Time Interval A B
Rise/Fall Time A
Positive/Negative Pulse Width A
Phase A rel B B rel A
Duty Cycle A

500 MEASUREMENTS
Frequency, Period, Totalize A&B

1 MEASUREMENT
Peak Amplitudes A,B

When using the binary HP-IB output mode, the available measurement memory is increased to 4095 measurements (2047 for dual result measurements). Processing of these samples can then be performed on the raw data to compute the appropriate measurement results, using an instrument controller.

Rear Panel Specifications

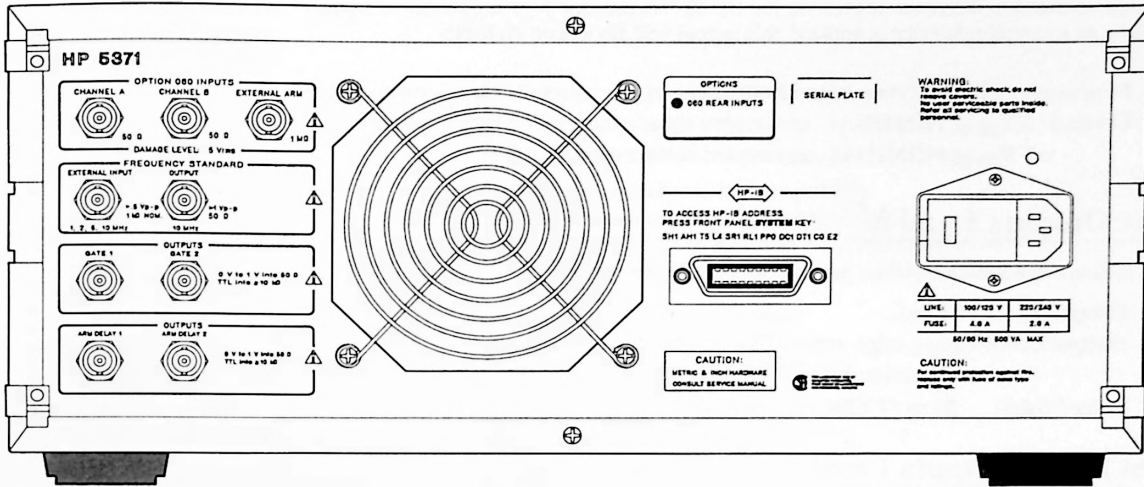

HP 5371A rear panel with Option 060, Rear Panel Inputs, installed.

Option 060 Rear Panel Inputs:

50Ω, BNC inputs for channel A and channel B and a 1 MΩ, BNC input for External Arm are available on the HP 5371A rear panel with Option 060. Input pods are not available with Option 060 installed (HP 54002A pods are deleted from the Option 060 configuration). Input channel A and B performance is equivalent to front panel performance for this configuration. External Arm performance for the Option 060 configuration is as follows:

Range: dc coupled to 100 MHz.

Sensitivity: 100 mV rms sine wave.

280 mV_{pk-pk} at a minimum pulse width of 5 ns.

Minimum Pulse Width: 5 ns (at a minimum amplitude of 280 mV_{pk-pk}).

Impedance: 1 MΩ NOMINAL, shunted by < 100 pf.

Dynamic Range: 280 mV_{pk-pk} to 5 V_{pk-pk}, dc to 20 MHz.

280 mV_{pk-pk} to 2.5 V_{pk-pk}, 20 MHz to 100 MHz.

Signal Operating Range: ± 5 Vdc.

Damage Level: 5 Vrms (± 15 V_{pk-pk}, dc ± peak ac).

All triggering specifications are the same as for the front panel configuration.

Frequency Standard External Input:

This BNC input will be automatically selected as the reference time base when a signal is present. The internal time base will be used when no signal is present at this BNC connector.

Impedance: 1 kΩ, ac coupled, NOMINAL.

Input Level Range: 1.0 V_{pk-pk} to 5.0 V_{pk-pk}.

Acceptable Frequencies: 1 MHz, 2 MHz, 5 MHz, or 10 MHz, ± 1%.

Damage Level: ± 10V (dc ± peak ac).

Frequency Standard Output:

When no external reference is present, the HP 5371A internal 10 MHz oscillator signal is provided at this output. When an external reference is applied, this output will always be 10 MHz.

Frequency: 10 MHz (Time base specifications apply except for short-term stability).

Level: $> 2 V_{pk-pk}$ NOMINAL, ac coupled square wave into a high impedance.

$> 1 V_{pk-pk}$ NOMINAL, ac coupled square wave into 50Ω .

Gate Outputs 1 and 2:

A falling edge indicates when measurement samples occur.

Delay: 30 ns TYPICAL.

Output Level: Falling edge active, TTL levels into $\geq 10 K\Omega$.

1 V (minimum) to 0 V into 50Ω .

Pulse Width: > 30 ns (TYPICAL) into 50Ω .

Arm Delay Outputs 1 and 2:

A falling edge occurs at these outputs with the completion of the arming condition. For example, if a time holdoff is specified, a falling edge will occur at the completion of the time holdoff.

Delay: 30 ns TYPICAL.

Output Level: Falling edge active, TTL levels into $\geq 10 K\Omega$.

1 V (minimum) to 0 V into 50Ω .

HP-IB Characteristics

Interface Capabilities:

Subset Identifier	Interface Function
SH1	Complete source handshake capability
AH1	Complete acceptor handshake capability
T5	Basic talker with serial poll and talk-only capabilities
TE0	No extended talker capability
L4	Basic listener
LE0	No extended listener capability
DT1	Device trigger capability
DC1	Complete device clear capability
RL1	Remote/local capability
SR1	Serial poll capability
PP0	No parallel poll capability
C0	No controller capability
E2	Three-state drivers

HP-IB Address:

The HP-IB address can be changed via the SYSTEM menu. This address is saved in non-volatile memory. The default HP-IB address is 03.

Characteristic Measurement Output Rates:

The HP 5371A sends measurements to an external HP-IB controller at the completion of each block of measurements. Characteristic output rates are listed accordingly. For example, the typical binary output rate for the Continuous Time Interval Mode is 20,000 measurements per second. This should be interpreted as "up to twenty, 1000 measurement blocks can be transferred in 1 second to an instrument controller."

The HP 5371A can transfer data to an HP-IB instrument controller in one of three formats:

ASCII

IEEE Double Precision Floating Point (matches HP 9000 Series 200/300 controller floating point format, no character conversion is required for these controllers)

Binary (raw binary results from the HP 5371A counting hardware. Results can be then be processed accordingly in the external computer)

For these benchmarks:

- These benchmarks are obtained using the HP 9000 Series 300 instrument controller with a DMA card installed. The "TRANSFER" statement is used to bring the data into the controller.
- The HP 5371A is configured to the PRESET condition before the appropriate function is selected. Statistical and math operations are not enabled. In addition, the MANUAL input triggering mode is used to set the input voltage trigger levels.
- Except where noted, a sample size of 10 blocks of 1000 measurements (10,000 total measurements) was used to determine these values.
- All values include the measurement time, as well as the transfer time, of the data using an input signal of 13 MHz (76.9 ns).
- For BINARY output rates, the values represent the number of measurements sent to the computer and stored in a buffer without processing. See note 5.
- For these benchmark rates, the header information at the beginning of each block was not processed.

Note that these are TYPICAL values; performance is also affected by other instrumentation on the bus, the performance of the external controller, and the particular measurement software.

CHARACTERISTIC HP-IB OUTPUT RATE

MEASUREMENT MODE	ASCII	(All values in "Readings per Second")	
		FLOATING POINT	BINARY
Time Interval A, B, A→B, B→A	150	350	12,500
Continuous Time Interval A, B	200	600	20,000
± Time Interval A, B, A→B, B→A	130	250	12,500
Frequency A, B	130	275	13,000
Frequency A&B ⁽¹⁾	50 per channel	110 per channel	5,300 per channel ⁽³⁾
Frequency A/B, B/A	90	140	5,500 per channel ⁽³⁾
Frequency A - B, B - A, A + B	90	140	5,500 per channel ⁽³⁾
Period A, B	130	275	13,000
Period A&B ⁽¹⁾	50 per channel	110 per channel	5,500 per channel ⁽³⁾
Period A/B, B/A	90	140	5,500 per channel ⁽³⁾
Period A-B, B-A, A + B	90	150	5,500 per channel ⁽³⁾
Totalize A, B	140	275	7,500
Totalize A&B ⁽¹⁾	80 per channel	175 per channel	5,200 per channel ⁽³⁾
Totalize A/B, B/A	90	175	5,200 per channel ⁽³⁾
Totalize A-B, B-A, A + B	125	225	5,200 per channel ⁽³⁾
Rise/Fall Time A	130	260	12,500 ⁽⁴⁾
Pulse Width A	130	260	12,500 ⁽⁴⁾
Phase A rel B, B rel A	90	150	12,500 ⁽⁴⁾
Duty Cycle A	110	200	12,500 ⁽⁴⁾
Peak Amplitudes A,B ⁽²⁾	5	5	N/A

⁽¹⁾ 10 blocks of 500 measurements (5000 total) were used for this benchmark value.

⁽²⁾ 10 measurements were used to characterize this value.

⁽³⁾ These measurement rates are the same as the "A&B" mode. Appropriate math calculations must be performed in the controller when the results are processed.

⁽⁴⁾ These measurement rates are essentially the same as the Time Interval A→B mode. Appropriate math operations must be included in the controller program to compute Phase A rel B, or B rel A and Duty Cycle A.

⁽⁵⁾ Binary output mode rates do not include processing time in the controller. This processing time will vary with the controller, the program language, and the particular program. As an example: 10,000 conversions per second can be achieved using an HP 9000 Series 320 controller. This value excludes the transfer time of the data from the HP 5371A.

HP-IB

The user may also configure the HP 5371A to output BINARY data indefinitely to an external controller. This is achieved by configuring the HP 5371A for 1 block of 1 measurement, in the REPETITIVE acquisition mode. A single binary result will be transferred at a TYPICAL rate of 75 measurements per second. This rate will also depend on the particular controller as well as other instruments connected to the bus.

The following BASIC program and PASCAL Compiled Subroutine (CSUB) were used to obtain the processing time benchmark.

```
10  INTEGER R(1:3003) BUFFER,I
20  DIM T(1:1001)
30  ASSIGN @Ctr TO 703
40  ASSIGN @Buff TO BUFFER R(*)
50  REMOTE @Ctr
60  OUTPUT @Ctr;"PRESET"
70  OUTPUT @Ctr;"MEAS;FUNC,CTIN"
80  OUTPUT @Ctr;"INP;SOUR A;TRIG MAN;LEV 0"
90  OUTPUT @Ctr;"MEAS;SSIZ 1000"
100 OUTPUT @Ctr;"INT;OUTP BIN"
110 OUTPUT @Ctr;"SMOD SING"
120 TRIGGER @Ctr
130 ENTER @Ctr USING "#,8A";Header$
140 TRANSFER @Ctr TO @Buff;COUNT VAL(Header$(3)),WAIT
150 T0=TIMEDATE
160 Fast_conv71(R(*),T(*))
170 T1=TIMEDATE
180 DISP "1000 MEASUREMENTS IN";T1-T0;"SECONDS."
190 PRINT T(*)
200 END
210 CSUB Fast_conv_71(INTEGER Raw_71_data(*),REAL Time_data(*))
```

Rocky Mountain BASIC routine used to benchmark the HP-IB processing time. The compiled subroutine (CSUB) source code is on the following page.

```

< RAW5371.TEXT                                     Last Rev: 9/24/87   >
$ SYSPROG $
$ STACKCHECK ON $ < * * * * * >
$ CALLABS ON $ < * >
$ OVFCHK ON $ < * (C) Copyright 1987 Hewlett-Packard * >
$ PARTIAL_EVAL ON $ < * All rights reserved. * >
$ RANGE OFF $ < * >
$ SEARCH 'CSUBDECL' $ < * * * * * >
$ FLOAT_MDW ON $

MODULE HPS371A;
IMPORT CSUBDECL;
EXPORT
  TYPE
    real_array2 = PACKED ARRAY [2..maxarraysize DIV 8] OF REAL;
    raw_rec = PACKED RECORD
      T : INTEGER;
      B1,B2 : byte;
    END;
    raw_rec_array = PACKED ARRAY [1..maxarraysize DIV 6] OF raw_rec;

  PROCEDURE Fast_conv71(
    VAR Raw_dim : dimentryptr;
    VAR Raw_71_data : raw_rec_array;
    VAR Time_dim : dimentryptr;
    VAR Time_data : real_array2 );

  ----->
  IMPLEMENT

  FUNCTION Total_entries(dim:dimentryptr):INTEGER;
  VAR
    I,Entries : INTEGER;
  BEGIN
    Entries:=dim^.bound[1].length;
    FOR I:=2 TO dim^.dims DO Entries:=Entries*dim^.bound[I].length;
    Total_entries:=Entries;
  END; <Total_entries>

  ----->

  PROCEDURE Fast_conv71;
  VAR
    I,Tot_entries : INTEGER;
    T0,T1 : REAL;
  BEGIN
    T0:=(Raw_71_data[1].T+ORD(Raw_71_data[1].T<0)*4294967296.0)
      *2.0E-9-1.0E-10*(Raw_71_data[1].B2 MOD 32);
    FOR I:=2 TO Total_entries(Raw_dim) DIV 3 DO
      BEGIN
        T1:=(Raw_71_data[I].T+ORD(Raw_71_data[I].T<0)*4294967296.0)
          *2.0E-9-1.0E-10*(Raw_71_data[I].B2 MOD 32);
        Time_data[I]:=T1-T0;
        T0:=T1;
      END;
    END;
  END; < HPS371A >

```

PASCAL compiled subroutine source code used to benchmark the binary result processing time. Using a CSUB improves the processing time of the binary data in the external controller.

HP-IB

Direct Printer or Plotter Output

Any HP 5371A CRT display may be sent directly to an HP-IB graphics printer such as the HP 2225A ThinkJet Printer using the TALK ONLY mode. In addition, a list of measurement results can be printed directly from the front panel (up to 1000 values).

Any HP 5371A Time Variation graph, Histogram graph, or Event Timing graph may be sent directly to an HP-IB HP-GL plotter such as the HP 7440A ColorPro Plotter option 002.

```
Frequency A:
SYSTEM _____
HP-IB Configuration:
Addressing Mode  TALK ONLY
Print           DISPLAY
Set printer to Listen Only.
Result Format    ASCII
Response Timeout ON      5 s
System Clock:   01 Jan 1987  01:11:40
Firmware Revision: 2739 [25 Sep 1987]
```

By placing the HP 5371A in TALK ONLY mode on the SYSTEM menu, results can be printed or plotted without the need for a system controller.

Response Timeout

The response timeout feature enables the user to program the HP 5371A to generate a service request if the measurement is not completed within a specified time.

Timeout Range: 0 to 10 hours.

Resolution: 1 second.

Default Value: 5 seconds.

Time Base Specifications

Oven Oscillator

FREQUENCY:

10 MHz.

STABILITY:

Aging Rate:

$< 5 \times 10^{-10}$ per day after 24 hour warm-up when:

1. oscillator off-time* was less than 24 hours.
2. oscillator aging rate was $< 5 \times 10^{-10}$ per day prior to turn-off*.

$< 5 \times 10^{-10}$ per day in less than 30 days of continuous operation for off-time* greater than 24 hours.

$< 1 \times 10^{-7}$ per year for continuous operation.

Short Term:

$< 1 \times 10^{-10}$ for a 1 second average.

Temperature:

$< 7 \times 10^{-9}$, 0 to 40°C ambient temperature.

Line Voltage:

$< 1 \times 10^{-10}$ for 10% change from the NOMINAL line voltage.

Warm-up:

Within 5×10^{-9} of final value (see below) 10 minutes after turn-on* when:

1. HP 5371A is operated in a 25°C environment.
2. Oscillator off-time* was less than 24 hours.
3. Oscillator aging rate was $< 5 \times 10^{-10}$ per day prior to turn-off*.

Final value is defined as oscillator frequency 24 hours after turn-on*.

Refer to the Rear Panel Specifications Section for information regarding signal levels.

*"Turn-off", "turn-on", and "off-time" apply to periods when power is disconnected from the HP 5371A rear panel. Standby operation provides power to the oscillator's oven.

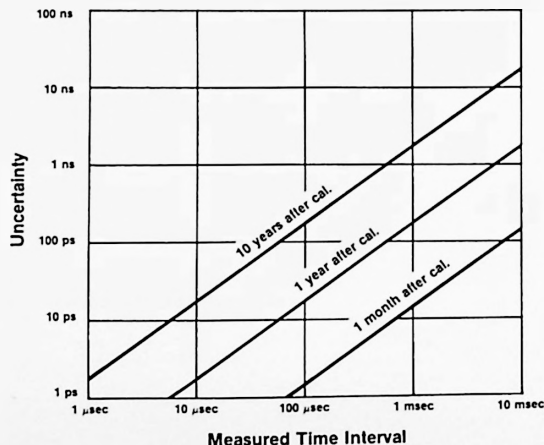
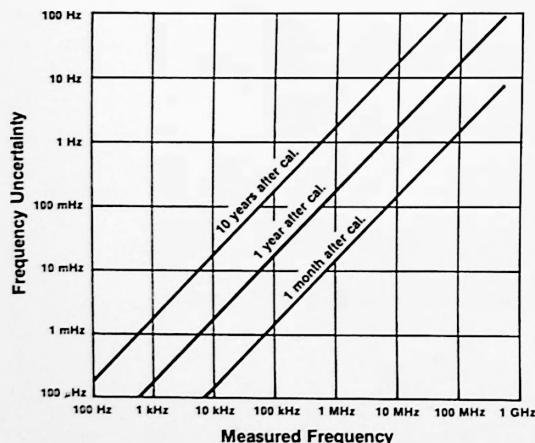

Timebase crystal aging affects Frequency and Period measurement accuracy. You can further reduce aging uncertainty by using an atomic standard.

Timebase crystal aging affects time interval measurements.

General Specifications

Dimensions:

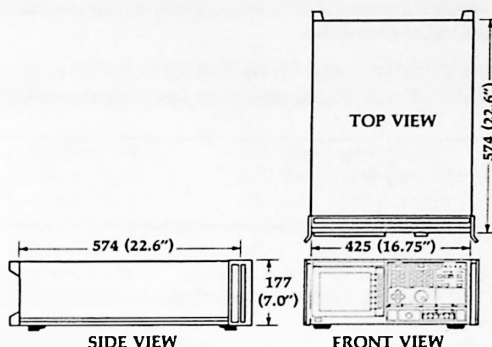

WEIGHT:

Net, 23.2 kg (51 lbs); Shipping, 24.5 kg (54 lbs).

OPERATING TEMPERATURE:

0 to 40°C.

POWER REQUIREMENTS:

Voltages: 100, 120, 220, or 240 Vac; +10%, -10%.

Frequencies: 50 to 60 Hz.

Maximum Power: 500 VA maximum.

Display Characteristics:

The HP 5371A features a raster-scan, green phosphor CRT. Screen display resolution is 408 pixels horizontally by 304 pixels vertically. Graph display resolution is 250 pixels horizontally by 200 pixels vertically.

For numeric displays, a BOLD feature is available to display results in large characters for viewing from a distance. Up to 12 measurements (6 measurements with associated "gate" data) can be displayed in the standard numeric display. All results may be viewed using scrolling features.

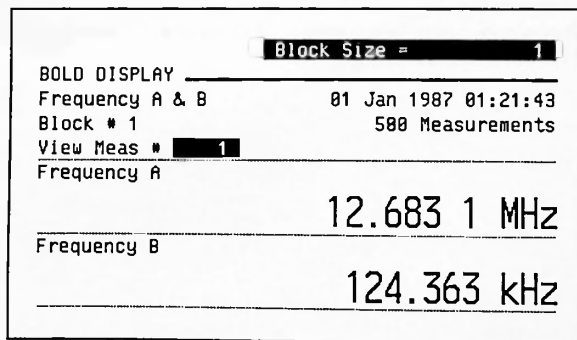

For applications where results must be viewed from a distance, the HP 5371A features a BOLD numeric display.

Results on the numeric screen will be displayed with a maximum of 15 digits, depending on the measurement resolution.

Ease-of-use Features:

INSTRUMENT STATES:

Up to 9 instrument states can be saved from the front panel or via HP-IB. The INSTRUMENT STATE screen depicts the function and arming mode for each saved state, as well as the time and date saved. Each state also has a PROTECT feature to prevent accidental overwrite.

In addition to the nine saved states, state 0 is saved for the last set-up prior to pressing the PRESET key or the DEFAULT MEASUREMENT SETUP key. These states are saved in non-volatile RAM.

Frequency A:			
INSTRUMENT STATE _____			
Reg	Write	Description	Date/Time
#	Protect	[Measurement:Arming]	Saved
0:	OFF	Previous Setup	01 Jan 00:33
1:	OFF	Time Intvl !Automatic	01 Jan 01:23
2:	ON	Cont. Time !Edge/Intvl	01 Jan 01:23
3:	OFF	+/- Time !Time/Time	01 Jan 01:24
4:	ON	Frequency !Ext Gated	01 Jan 01:24
5:	ON	Period !Intvl Samp	01 Jan 01:24
6:	OFF	Totalize !Edge Samp	01 Jan 01:24
7:	ON	Rise Time !Automatic	01 Jan 01:25
8:	OFF	Phase !Automatic	01 Jan 01:25
9:	ON	Peak Ampl !Automatic	01 Jan 01:25

Up to 9 instrument states may be saved from the front panel, or via HP-IB. State 0 is reserved for the last instrument state prior to PRESET or DEFAULT MEAS SETUP.

PRESET AND DEFAULT MEASUREMENT SETUP:

A preset function is available to return the HP 5371A to a known state, specifically Time Interval A. Instrument states and the HP-IB address are not affected, however measurement memory is cleared.

The Default Measurement Setup function is available to quickly begin making measurements for a given function. A sample size of 50 measurements is selected, with statistics on. The instrument automatically goes to the Numeric Display.

TEACH-LEARN:

Programming can be simplified by configuring the HP 5371A to a particular setup from the front panel and then sending this setup to an HP-IB controller as a "learn string". The controller can then send this string at an appropriate time to the HP 5371A as a "teach string".

SELF-TEST:

The HP 5371A automatically runs a test of internal circuitry at power-on. In addition, a similar self-test can be invoked at any time from the front panel or from HP-IB. Failures are noted on the CRT for both types of tests and over HP-IB, or can be logged on a printer directly using the TALK ONLY mode.

In addition to Self Tests, the HP 5371A allows diagnostic tests to be performed individually on portions of its internal circuitry.

DIAGNOSTIC TESTS	
1. Self Test	16. DMA Controller
2. Time Base	17. Front Panel
3. Input Pods	18. CRT Adjustment
4. Input Amplifiers	19. CRT Video Pattern
5. Count ICs	20. External Amp
6. Gate Timer	21. Calibrate Interps
7. Measurement RAM	
8. System ROM	
9. System RAM	
10. Timer	
11. Real Time Clock	
12. CRT RAM	
13. LED Latch	
14. CRT Controller	Test Number: 1
15. Key Controller	

The HP 5371A offers a complete set of diagnostics and self test for instrument troubleshooting.

"SECURITY" MODE AND DISPLAY CONCEALMENT:

For classified system applications, results can be blanked from the HP 5371A CRT display. Status messages will be displayed, but measurement results will not appear. All measurement data can be retrieved over HP-IB. In addition, all front panel keyboard functions except the numeric keypad and the RESTART key are locked out. This mode is retained during instrument power-down and can be exited by entering a security code.

MEASUREMENT ABORT:

A measurement process may be suspended before the end of the current block without loss of data by pressing the MANUAL ARM key on the front panel or by the HP-IB command "ABORT". Measurements acquired up to that point can be accessed from the front panel or via HP-IB.

HELP SCREENS:

The HP 5371A offers a series of help menus giving summary information on its operation. These screens can be accessed from front panel menus.

HELP MENU: Example SAMPLING Arming

Frequency A (4 measurements)
INTERVAL SAMPLING Arming

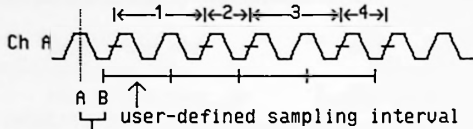

A - 5371A is automatically armed.
B - First interval starts after a delay.
Measurements are taken following the user-defined sampling interval.

Interval range: 600 nS to 8.0 S.
resolution: 200 nS.

HP 5371A help screens replace bulky pull-out cards with quick and helpful operating information.

STATUS MENU:

The status menu gives a complete summary of current setup information. This screen can be used to document a particular measurement setup, as well as view the entire instrument setup at a glance.

Frequency A:

STATUS _____ 01 Jan 1987 01:33:14

Measurement: Frequency A Freq Std.: Internal
Block Size: 16 Meas Size: 1

<p>Arming _____</p> <div style="border: 1px solid black; padding: 2px;"> <p>Mode: Event/Interval</p> <p>Block Holdoff</p> <p>Pos edge of Ext Arm, then 158 pos edges of Chan B</p> </div> <div style="border: 1px solid black; padding: 2px; margin-top: 5px;"> <p>Sample Arm</p> <p>10.0 us</p> </div>	<p>Trigger Level _____</p> <p>Chan A: 50% p-p Pos edge Chan B: 50% p-p Pos edge Ext Arm: 0 V</p> <p>Input _____</p> <p>Chan Coupling: Separate</p> <table border="0" style="width: 100%; border-collapse: collapse;"> <thead> <tr> <th></th> <th style="text-align: center; border-bottom: 1px solid black;">Chan A</th> <th style="text-align: center; border-bottom: 1px solid black;">Chan B</th> </tr> </thead> <tbody> <tr> <td>Pod:</td> <td style="text-align: center;">HP 54002</td> <td style="text-align: center;">HP 54002</td> </tr> <tr> <td>Imped:</td> <td style="text-align: center;">50 ohm</td> <td style="text-align: center;">50 ohm</td> </tr> <tr> <td>Bias:</td> <td style="text-align: center;">GND</td> <td style="text-align: center;">GND</td> </tr> <tr> <td>Atten:</td> <td style="text-align: center;">1:1</td> <td style="text-align: center;">1:1</td> </tr> </tbody> </table>		Chan A	Chan B	Pod:	HP 54002	HP 54002	Imped:	50 ohm	50 ohm	Bias:	GND	GND	Atten:	1:1	1:1
	Chan A	Chan B														
Pod:	HP 54002	HP 54002														
Imped:	50 ohm	50 ohm														
Bias:	GND	GND														
Atten:	1:1	1:1														

Result Processing _____

Statistics: Off
Math/Reference: Off
Limits: Off

The status menu screen gives you a complete overview of the current HP 5371A configuration. This screen is also useful to document the instrument configuration for your lab notebook.

Appendix

Measurement Uncertainties

All measured values have associated uncertainties. The following are definitions of terms used to describe these uncertainties. For frequency and time interval measurements and other specific implementations (i.e. rise time, pulse width, duty cycle etc.) this measurement uncertainty is composed of three factors: Least Significant Digit (LSD), Resolution, and Accuracy.

Least Significant Digit, Resolution, and Accuracy

Least Significant Digit is the smallest incremental value displayed in a measurement. The LSD for the HP 5371A is 200 ps, therefore, the smallest displayed increment that two single-shot time interval measurements will differ by is 200 ps.

Resolution is the smallest difference in measurements that the instrument can discern. Measurement resolution is of primary concern when comparing data gathered by a single instrument; in other words, the meaning of results when compared against one another. Resolution describes uncertainty due to random effects, including short-term oscillator stability, trigger error, and the internal noise of the instrument itself. Since these effects are random, the resolution uncertainty is specified on an rms basis rather than a peak value. The time interval single-shot resolution of the HP 5371A is 150 ps rms. Resolution can also be improved by averaging single measurements, or in the case of frequency and period measurements, by increasing the measurement gate time as well as averaging measurements.

Accuracy is defined to be the combination of random uncertainties and systematic or bias uncertainties in a measurement. Accuracy is of primary concern when comparing data in an absolute sense, such as one production test station to the next. Systematic uncertainties include differential channel delay, long term drift or time base oscillator aging, and trigger level timing error. These uncertainties may be measured and removed from subsequent measurement data by subtracting the measured bias. Two methods are available to do this with the HP 5371A: the SET REFERENCE feature for each input channel, or the HP J06-59992A Time Interval Calibrator.

$$\text{Accuracy} = \text{Random Errors} + \text{Systematic Errors}$$

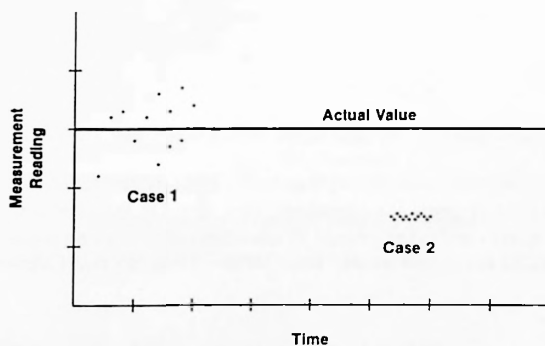

Case 1 shows the results of random uncertainties (resolution) limiting measurement precision. Case 2 shows the results of systematic uncertainty limiting measurement precision. Accuracy specifications must include both systematic and random effects.

Trigger Error and Trigger Level Timing Error

Resolution and accuracy equations consist of two terms which describe uncertainties due specifically to triggering. These terms are separated from others since they are, in general, dependent upon the user's signal. The following describes these input trigger uncertainties.

Trigger Error is a random uncertainty caused by noise on the input signal. Trigger error can be minimized by careful grounding and shielding techniques to minimize noise, and maintaining as high a signal slew rate as possible for the input to the HP 5371A. The following equation is used to quantify trigger error.

$$\text{Trigger Error} = \frac{\sqrt{(E_{\text{amp}})^2 + (E_n)^2}}{\text{Input Signal Slew Rate}}$$

Where:

- E_{amp} is the typical rms input amplifier noise: (200 μV rms TYPICAL), and
- E_n is the rms noise of the input signal over a 500 MHz bandwidth.
- The input signal slew rate value is determined at the trigger point.

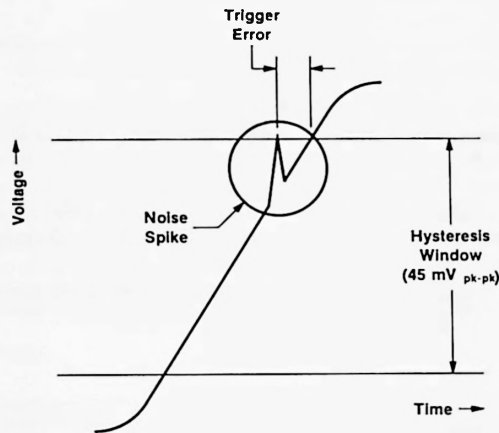

Trigger error is due to noise on the input signal. Here a noise spike causes an early "trigger".

Trigger Level Timing Error is a systematic uncertainty due to the input hysteresis of the HP 5371A. Trigger Level Timing Error is a constant value for any particular signal and slew rate, but the effects will vary with amplitude and slew rate. Trigger Level Timing Error can be minimized by maintaining as high an input signal slew rate as possible, and can be removed by careful calibration with the HP J06-59992A Time Interval Calibrator.

$$\text{Trigger Level Timing Error} = \frac{(0.5 \times \text{hysteresis window})}{\text{Start input signal slew rate}} - \frac{(0.5 \times \text{hysteresis window})}{\text{Stop input signal slew rate}} \pm$$

$$\frac{\text{Trigger Level Accuracy (start)}}{\text{Start input signal slew rate}} \pm \frac{\text{Trigger Level Accuracy (stop)}}{\text{Stop input signal slew rate}}$$

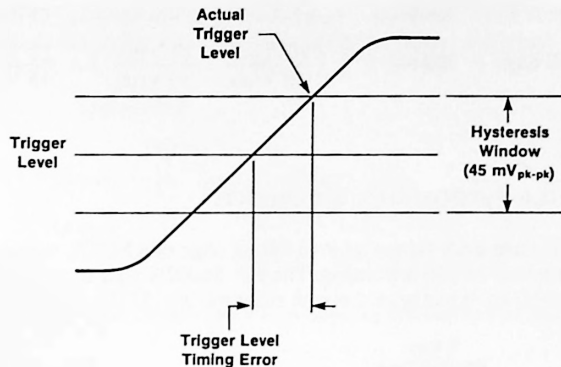

Trigger level timing error is a systematic uncertainty, constant for any particular signal slew rate.

Measurement Uncertainty Examples:

The following are measurement examples to illustrate the use of the measurement uncertainty equations for typical measurement applications. In these examples, the specific values have been entered into the complete equation. In practice, the associated graphs of these equations can be used to determine various uncertainties.

TTL PULSE WIDTH MEASUREMENT:

A single-shot pulse width measurement is made with a value of 100.0 ns. The signal has 10 mV rms (28mV_{pk-pk}) noise, a rise time of 20 ns, and a fall time of 10 ns over a 3 volt swing. The measurement is made using the HP 54003A 1 MΩ input pod with a 10:1 divider probe. It has been 1 month since the HP 5371A timebase has been calibrated.

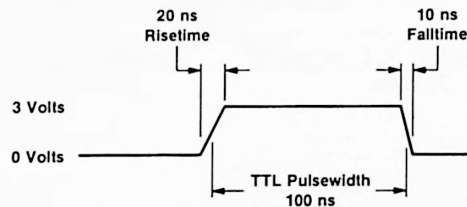

TTL pulse width measurement uncertainty example.

LSD:

$$= \pm 200 \text{ ps.}$$

Resolution:

$$= \pm 150 \text{ ps rms} \pm \text{Start Trigger Error} \pm \text{Stop Trigger Error.}$$

$$= \pm 150 \text{ ps rms} \pm \frac{\sqrt{(200 \mu\text{V rms})^2 + (10 \text{ mV rms})^2}}{15 \text{ V}/\mu\text{s}} \pm \frac{\sqrt{(200 \mu\text{V rms})^2 + (10 \text{ mV rms})^2}}{30 \text{ V}/\mu\text{s}}$$

$$= \pm 1.15 \text{ ns rms.}$$

Accuracy:

$$= \pm \text{Resolution} \pm (\text{Time Base Aging} \times \text{Pulse Width}) \pm \text{Trigger Level Timing Error} \pm 1 \text{ ns Systematic Error.}$$

$$= \pm 1.15 \text{ ns rms} \pm (5 \times 10^{-10} \times 30 \text{ days} \times 100 \text{ ns}) \pm \left[\left(\frac{22.5 \text{ mV}}{15 \text{ V}/\mu\text{s}} - \frac{22.5 \text{ mV}}{30 \text{ V}/\mu\text{s}} \right) \pm \frac{21.5 \text{ mV}}{15 \text{ V}/\mu\text{s}} \pm \frac{21.5 \text{ mV}}{30 \text{ V}/\mu\text{s}} \right]$$

$$\pm 1 \text{ ns Systematic Error.}$$

$$= \pm 3.62 \text{ ns.}$$

ECL EDGE-TO-EDGE, OR SINGLE-PERIOD MEASUREMENT:

A single-shot period measurement is made from falling edge to falling edge of a MECL signal. The input signal has 1 mV rms of noise with a fall time of 2.5 ns over an 800 mV swing. The HP 54002A 50Ω input pod is used with a -2 volt termination. The measured value is 10.0 ns. It has been 1 month since the HP 5371A timebase has been calibrated.

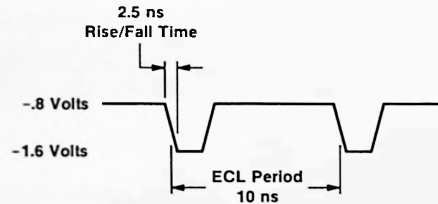

Measurement uncertainty example using Time Interval to measure from falling edge to falling edge of an ECL signal.

LSD:

$$= \pm 200 \text{ ps.}$$

Resolution:

$$= \pm 150 \text{ ps rms} \pm \text{Start Trigger Error} \pm \text{Stop Trigger Error.}$$

$$= \pm 150 \text{ ps rms} \pm \frac{\sqrt{(200 \mu\text{V rms})^2 + (1 \text{ mV rms})^2}}{32 \text{ V/ns}} \pm \frac{\sqrt{(200 \mu\text{V rms})^2 + (1 \text{ mV rms})^2}}{32 \text{ V/ns}}$$

$$= \pm 156 \text{ ps rms.}$$

Accuracy:

$$= \pm \text{Resolution} \pm (\text{Time Base Aging} \times \text{Time Interval}) \pm \text{Trigger Level Timing Error} \pm 1 \text{ ns Systematic Error.}$$

$$= \pm 156 \text{ ps rms} \pm (5 \times 10^{-10} \times 30 \text{ days} \times 10 \text{ ns}) \pm \left[\left(\frac{22.5 \text{ mV}}{32 \text{ V/ns}} - \frac{22.5 \text{ mV}}{32 \text{ V/ns}} \right) \pm \frac{24 \text{ mV}}{32 \text{ V/ns}} \pm \frac{24 \text{ mV}}{32 \text{ V/ns}} \right]$$

$$\pm 1 \text{ ns Systematic Error.}$$

$$= \pm 1.31 \text{ ns.}$$

Note that a major portion of the measurement accuracy consists of the 1 ns systematic term. This can be reduced to less than 10 ps with careful calibration using the J06-59992A Time Interval Calibrator.

ECL FREQUENCY MEASUREMENT:

A frequency measurement is made on a 100 MHz ECL signal with a 1 μ sec sample interval. The signal has 1 mV of noise with a transition time of 2.5 ns over an 800 mV swing. The HP 54002A 50 Ω input pod is used with a -2 volt termination. It has been 1 month since the HP 5371A timebase has been calibrated.

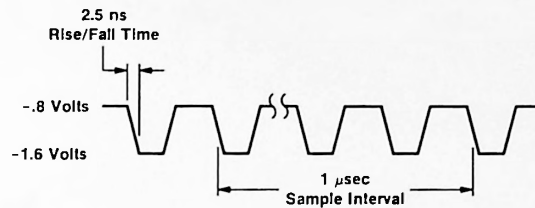

Measurement uncertainty example for a frequency measurement on an ECL signal.

LSD:

$$\begin{aligned}
 &= \pm \frac{(200 \text{ ps} \times \text{Frequency})}{\text{Sample Interval}} \\
 &= \pm \frac{(200 \text{ ps} \times 100 \text{ MHz})}{1 \mu\text{s}} \\
 &= \pm 20 \text{ kHz}.
 \end{aligned}$$

Resolution:

$$\begin{aligned}
 &= \pm \frac{150 \text{ ps rms} + (1.4 \times \text{Trigger Error})}{\text{Sample Interval}} \times \text{Frequency}. \\
 &= \pm \frac{150 \text{ ps rms} + (1.4 \times \frac{\sqrt{(200 \mu\text{V rms})^2 + (1 \text{ mV rms})^2}}{.32 \text{ V/ns}})}{1 \mu\text{s}} \times 100 \text{ MHz}. \\
 &= \pm 15.4 \text{ kHz}.
 \end{aligned}$$

Accuracy:

$$\begin{aligned}
 &= \pm \text{Resolution} \pm (\text{Time Base Aging} \times \text{Frequency}). \\
 &= \pm 15.4 \text{ kHz} \pm (5 \times 10^{-10} \times 30 \text{ days} \times 100 \text{ MHz}). \\
 &= \pm 15.4 \text{ kHz}.
 \end{aligned}$$



Table 1. HP 5371A Arming Modes

Arming Mode	Measurement Function										
	Time Interval ¹	Continuous Time ²	±Time Interval ¹		Frequency, Period ²		Totalize ²		Pos Width, Neg Width, Rise Time, Fall Time, Duty Cycle ¹	Phase ²	Peak Amplitude
	A B A-B B-A	A B	A B	A-B B-A	A B	A&B A/B A+B A-B B-A	A B	A&B A/B A+B A-B B-A	A	A rel B B rel A	A B
Automatic											
Automatic	C*	C*		C*	C*	C*			C*	C*	N*
Holdoff											
Edge Holdoff	C	C		C							
Time Holdoff	C	C									
Event Holdoff	C	C									
Sampling											
Interval Sampling	C	C		C	C	C	C*	C*			
Time Sampling					N						
Cycle Sampling					C						
Edge Sampling					C	C	C	C			
Parity Sampling				C							
Repetitive Edge	C	C		C							
Repetitive Edge/Parity				C							
Holdoff/Sampling											
Edge/Interval	C	C		C	C	C	C	C			
Edge/Time					N						
Edge/Edge					C		C	C			
Externally Gated					N		N	N			
Edge/Cycle					C						
Edge/Event			N	N	N						
Edge/Parity				C							
Time/Interval					C		C				
Time/Time			N	N	N						
Event/Interval					C						
Event/Event			N*	N	N						
Manual							N	N			

C = Continuous Measurements (Block/Measurement Arming)

N = Non-continuous Measurement (Start/Stop Arming)

* = Default Arming

1 = "Individual" Continuous Type

2 = "Back-to-Back" Continuous Type

Arming Categories

Category	Holdoff	Sampling
Automatic	None (Automatic)	Automatic
Holdoff	User-defined	Automatic
Sampling	None (Automatic)	User-defined
Holdoff/Sampling	User-defined	User-defined

For more information, call your local HP sales office listed in your telephone directory or an HP regional office listed below for the location of your nearest sales office.

United States:

Hewlett-Packard Company
4 Choke Cherry Road
Rockville, MD 20850
(301) 670-4300

Hewlett-Packard Company
5201 Tollview Dr.
Rolling Meadows, IL 60008
(312) 255-9800

Hewlett-Packard Company
5161 Lankershim Blvd.
No. Hollywood, CA 91601
(818) 505-5600

Hewlett-Packard Company
2015 South Park Place
Atlanta, GA 30339
(404) 955-1500

Canada:

Hewlett-Packard Ltd.
6877 Goreway Drive
Mississauga, Ontario L4V1M8
(416) 678-9430

Japan:

Yokogawa-Hewlett-Packard Ltd.
29-21, Takaido-Higashi 3-chome
Suginami-ku, Tokyo 168
(03) 331-6111

Latin America:

Hewlett-Packard de Mexico
Sp. A. de C. V.
Monte Pelvux No. 111
Lomas de Chapultepec
11000 Mexico D.F., Mexico
(905) 596-79-33

Australia/New Zealand:

Hewlett-Packard Australia Ltd.
31-41 Joseph Street
Blackburn, Victoria 3130
Melbourne, Australia
(03) 895-2895

Far East:

Hewlett-Packard Asia Ltd.
22/F Bond Centre
West Tower
89 Queensway
Central, Hong Kong
(5) 8487777

Germany:

Hewlett-Packard GmbH
Vertriebzentrale Deutschland
Hewlett-Packard-Strasse
Postfach 1641
6380 Bad Homburg v.d.H.
Federal Republic of Germany
06172/400-0

France:

Hewlett-Packard France
Parc d'activit  du Bois Briard
2, avenue du Lac
91040 Evry Cedex
01/60 77 83 83

United Kingdom:

Hewlett-Packard Ltd.
Enquiry Group
Customer Support Centre
Eskdale Road
Winnersh Triangle
Wokingham
Berkshire RG11 5DZ
0734/69 66 22

Italy:

Hewlett-Packard Italiana S.p.A.
Via G. di Vittorio, 9
20063 Cernusco Sul Naviglio (MI)
Milano
02/923691

European Multi Country Region:

Hewlett-Packard S.A.
Route du Nant d'Avril 150
1217 Meyrin 2—Geneva
Switzerland
(41) 22/83 81 11

Or write to:

United States:

Hewlett-Packard Company
P.O. Box 10301,
Palo Alto, CA 94303-0890

Europe/Middle East/Africa:

Hewlett-Packard Company
Central Mailing Department
P.O. Box 529
1180 AM Amstelveen
The Netherlands

For all other areas:

Hewlett-Packard Company
Intercontinental Headquarters
3495 Deer Creek Rd.
Palo Alto, CA 94304
U.S.A.

